



# UNLOCKING EARTH

*One step further towards a conventional use of rammed  
earth as a building material in Sweden.*

**Matilda Olsson**

Chalmers University of Technology  
- Department of Architecture and Civil Engineering  
Examiner: Walter Unterrainer  
Supervisor: Shea Hagy

Thank you!

I would like to thank my supervisor Shea Hagy for inspiring me to choose earth as the topic for my master's thesis, and together with my examiner Walter Unterrainer for their support throughout this thesis. Their guidance and encouragement have been very valuable to me.

I would also like to extend my thanks to Vera Matsdotter, from Wingårdh architects, for her engagement and help finding a suitable redesign object for my work.

I am also very grateful for my friends and family who have supported me during this time.



**CHALMERS**  
UNIVERSITY OF TECHNOLOGY

Unlocking Earth  
Matilda Olsson  
Chalmers University of Technology  
Department of Architecture and Civil Engineering

Examiner: Walter Unterrainer  
Supervisor: Shea Hagy  
MPDSD - Design and Planning Beyond Sustainability  
Gothenburg, Sweden 2022

## ABSTRACT

Earth is a material with excellent health properties, low embodied energy, and the possibility of being indefinitely recyclable. As a structural building material, it has great potential in reducing emissions caused by the building sector.

This master's thesis is exploring the limits of implementing rammed earth in a Swedish context, and how to overcome them through design. Building laws and regulations, climate, costs, and rammed earth knowledge are all topics considered relevant and where the exploration is initiated.

Swedish building regulations are in general quite vague, and definite conclusions are hard to make. Most challenges are found when looking at mechanical resistance and durability. There are multiple new, as well as ancient examples around the world proving its potential, though the impact of the Swedish climate, with intense wind and rain, is uncertain due to water solubility. An array of solutions to handle erosion are discussed in this thesis.

The procedure of approving new building materials is another challenge, it is currently adapted to conventional industrial materials, and not materials with varying properties like earth. Prefabrication, which already has been initiated on a small scale, can be a solution. It enables careful and frequent monitoring and testing, ensuring good quality. Prefabrication also brings down the costs, making it more time-efficient with fewer in situ manpower hours. With set routines, knowledge will increase which is necessary for the development of rammed earth in Sweden.

All challenges in implementing rammed earth in a Swedish context are considered solvable, but the first steps and investments needed are huge in proportion to the lack of demand on the market. The much-needed transition into a more sustainable society is approaching, and with it comes a demand for more sustainable building solutions, where rammed earth is prominent.

The investigation is resulting in a redesign of an already existing design, using rammed earth. Details are adapted to the circumstances of each individual element, and the proposal can thereby, be viewed as a compilation of possible wall compositions using rammed earth in a Swedish context.

Keywords: Excavated clay, rammed earth, prefabrication, BBR, erosion.

*"It is true that reinforced concrete (a brilliant late 19th-century invention whose energy consumption and pollution levels in the manufacturing stage have recently been slightly reduced) is vital to some public works and large buildings. However, it is worth stressing that in most homes and small to medium-sized buildings, it is perfectly possible to replace it with untransformed natural materials such as raw earth."*

- Dethier (2020, p. 13)

## THE AUTHOR

### *Matilda Olsson*

matildaolsson@telia.com  
+46705155906

## STUDENT BACKGROUND

2020 -

### *Design and planning beyond sustainability, Msc Program*

Chalmers University of Technology

### **Spring 2022**

Master's Thesis, Building design for sustainability.

### **Fall 2021**

Erasmus Exchange program - KU Leuven - Belgium

### **Spring 2021**

Design studio: Sustainable architectural design.

Managing design projects.

History, theory and method 3.

### **Fall 2020**

Design studio: Design and planning for social inclusion.

Sustainable development and the design professions,

Spring 2020

### **Internship**

#### **Rstudio for architecture**

Gothenburg, Sweden

Fall 2019

### **Architectural competitions**

2019

### **Bachelor's degree in Architecture**

Chalmers University of Technology.

## LIST OF CONTENT

Abstract	5
The author	7
Student background	7
Glossary	9
<b>I. Introduction .....</b>	<b>11</b>
Background	12
- Earth properties	12
- Rammed earth	14
- Local context	14
Purpose	15
Research Questions	15
Method	16
Delimitation	17
<b>II. What are the limits? .....</b>	<b>19</b>
Chapter Overview	20
- Limits categories	20
- Analysis	20
Swedish building standards and regulations.	21
- Technical construction requirements:	21
- Swedish regulations and rammed earth	22
- Laws and regulations overview	24
- Summary	28
Climate	29
- Erosion	30
- Comparing climates	31
- Rain and temperature	31
- Wind	31
- Comparison	33
Building costs	34
- Conventional walls	34
- Rammed earth wall	34
- Economical viability	36
- Summary	37
"What are the limits?" Conclusion	38
<b>III. Overcoming the limits .....</b>	<b>39</b>
Erosion	40
- Protection against erosion - Design strategies	40
- Erosion test	42
- Analysis	46
Prefabrication	48
- Joints	50
- Summary	52
"Overcoming the limits" Conclusion	52

<b>IV. Application .....</b>	<b>53</b>
Criteria	54
Viadal ekoby (eco-village)	54
- The rowhouse	57
- Rowhouse in pieces	58
Detail cut 1	61
- Detail overview	63
- Greenhouse wall	65
- Separating wall	67
Detail cut 2	73
- Exterior wall	75
<b>V. Discussion .....</b>	<b>78</b>
- Q1. What are the obstacles in implementing rammed earth in a Swedish context?	78
- Q2. How can one through design overcome the limits of rammed earth in a Swedish context?	78
- Future potential	79
- Conclusion	80

<b>List of references .....</b>	<b>82</b>
---------------------------------	-----------

<b>Appendix .....</b>	<b>85</b>
-----------------------	-----------

## GLOSSARY

<b>Clay</b>	Composed of fine-grained minerals. It is water-soluble and hardens when it dries. As long as it is not fired, the drying process is reversible.
<b>Earth</b>	A mixture of clay, sand, and gravel. Frequently found in nature.
<b>Earth building</b>	Building made of earth, construction method undefined.
<b>Gravel</b>	A mixture of different sizes of stones, ranging up to 32mm.
<b>Prefabrication</b>	Rammed earth elements fabricated as blocks on ground level, either in situ or off-site, and later assembled as a massive structure.
<b>Rammed earth</b>	Massive earthen building technique.
<b>Ramming</b>	A method of compacting loose moist earth mixtures into solid masses.
<b>Stabilizers</b>	Additives that improve the performance and durability of the wall, often by restraining the recyclability of the material.

(Definitions based on Rauch, 2015)

## **I. INTRODUCTION**

The introduction gives a background to the topic, an overview of earth properties specifically rammed earth, and presents the research questions of this master's thesis.

The content in this part is necessary knowledge to understand the following parts and the purpose of this master thesis.

## I. Introduction

### BACKGROUND

Earth is known to have been used as a building material for over 11,000 years and has independently emerged all over the globe. (Dethier, 2020) Rammed earth as a building technique that has been forgotten throughout history but is now in times of climate crisis reemerging as a sustainable solution in the building industry. Earth is widely available as a local resource all over the world. In its raw form, it has a very low embodied energy and the potential of being indefinitely recyclable, without loss of quality. In addition to its outstanding sustainability properties, the use of raw earth generates a good indoor climate by regulating moisture, absorbing smells as well as providing thermal inertia. (Dethier, 2020) It is a safe material during all its phases, from excavation to construction and usage, with no negative impact on human health. (Heringer et al., 2020)

On construction sites, excavated earth is seen as waste material with a costly organization to remove. Especially urban projects are facing this challenge and Västlänken in Gothenburg (new metro) is alone estimated to excavate 1 500 000 m<sup>3</sup> of earth during its construction. (Matsdotter, 2020) These huge amounts of material, also known as construction waste, can be seen and circular building material satisfying the urgent need for new housing units in Gothenburg. Instead of depending on new advanced technology to solve the climate crisis, it is possible and maybe even necessary to look for inspiration in the past where fossil material did not yet exist. The movement of using earth in modern buildings has already started, but there is still a long way to go before it will be seen as a conventional material.

One of the main challenges of implementing earth, specifically rammed earth, as a building material in Sweden is that it is not yet tested and approved by Swedish building standards. In general, countries tend to implement overly strict legislation due to a lack of knowledge, which leads to the usage of unnecessary additives like cement, hindering the advantages of sustainability and health. (Dethier, 2020) This thesis aims to explore the challenges

rammed earth faces in a Swedish context and how to overcome them, using the Swedish laws and regulations as a starting point.

### Earth properties

The use of earth is challenging since it's not a standardized building material. Depending on the site for excavation the composition of the earth differs, which leads to varying mixtures to achieve desired construction performances. Each site must be individually tested.

During the drying process, cracks appear due to an average shrinkage of 0.4-2% for mixtures used in rammed earth. The number of cracks can be minimized by reducing the proportion of water and earth, as well as optimizing the grain size and using additives. As long as additives are not used, earth is water-soluble and needs protection against erosion. It can be in the form of overhanging roofs or sufficient surface coatings, further discussed on page 40.

Even though there are challenges using earth, there are also advantages in comparison to more conventional materials. An earthen wall acts as a regulator for humidity, increasing the quality of the indoor climate. It has good properties for thermal inertia, storing heat and mitigating temperature differences. In addition to this, the energy needed to excavate, prepare, transport, and make the earthen wall in situ is ca. 1% of the energy needed for transporting and producing conventional materials like concrete and fired bricks. While these conventional materials are facing challenges regarding reuse and recycling, earth is indefinitely recyclable if additives like cement are avoided. (Minke, 2006).

To fulfill overly strict regulations, stabilizers are often added to the earth mixture to achieve new properties. In this report, stabilizers are referring to additives mixed into the earth content and seen as something that should be avoided.

### Material properties

	Rammed earth	Concrete	Wood	Bricks	
Density	2250	2200	500	1500	kg/m <sup>3</sup>
Compressive strength	0.5-5	10-130	7-64	12-65	N/mm <sup>2</sup>
Tensile strength	0.2-0.5	1-10	2.5-165	1.2-13	N/mm <sup>2</sup>
Shrinkage ratio	0.5 - 2	0.04-0.08	-	-	%
Drying period	28-42	28	-	-	days
Thermal conductivity	1.0	1.7	0.14	0.7	W/mK
Heat capacity	1.0-1.2	1.0	1.6	1	kJ/kgK
Embodied energy	9.3	229	-680	565.2	kgCO <sub>2</sub> eq/m <sup>3</sup>

Figure 1. Material properties table. (Burström, 2021; Lehm Ton Erde, n.d.; Minke, 2006; Tekniska Egenskaper, n.d.; The Construction Material Pyramid, n.d.)

### Embodied energy

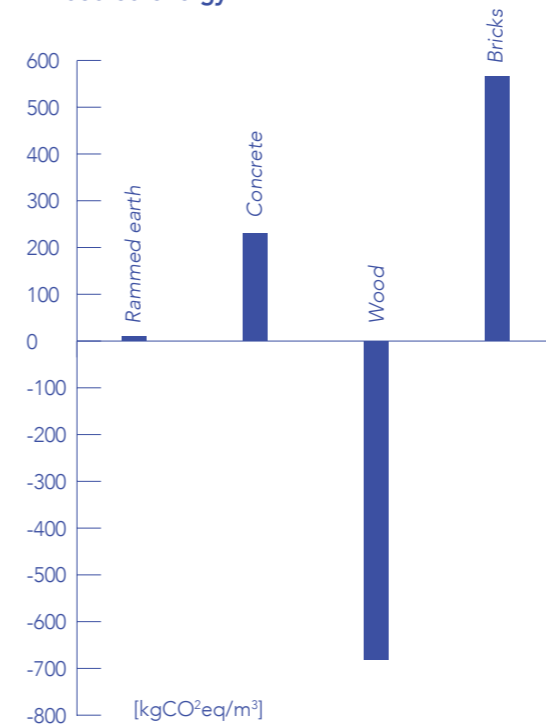

Figure 2. Material properties diagram. (Burström, 2021; Lehm Ton Erde, n.d.; Minke, 2006; Tekniska Egenskaper, n.d.; The Construction Material Pyramid, n.d.)

### Material comparison

Property numbers that differ rammed earth the most from other materials are compressive/tensile strength, long drying period, and low embodied energy. Rammed earth is not fit to span over big openings but performs well under compressive strength. In small-scale structures, the safety factor of using concrete is extreme for its purpose. A traditionally rammed earth wall with a thickness of around 50 cm is loaded with stresses of about 0.1-0.3 N/mm<sup>2</sup>, and with an estimated compressive strength of 1 N/mm<sup>2</sup>, the safety factor would be about 3-10 which should be considered more than safe (Bui et al., 2009).

When looking at the embodied energy, it is very low in relation to other materials, overlooking wood which has a negative value due to carbon storage in the material (whether this is fair, is debated in the field). This low value is one of the strongest advantages of rammed earth, it has a very low environmental footprint, is inevitably reusable, and provides a healthy indoor climate.

## I. Introduction

### Rammed earth

Earth buildings in general have great potential in regards to sustainability and improved indoor climate, though in the context of this thesis, specifically rammed earth has been chosen as the building technique. Rammed earth is aesthetically attractive, with a characteristic surface appearance. The design possibilities are many, ranging from minimalistic design to organic shapes, similar to concrete. Concrete is a material that could easily be replaced by rammed earth in most small- to medium-scale buildings, with a drastically reduced carbon footprint.

Rammed earth walls are produced by ramming earth into formworks in layers. Each layer is compressed before the next layer is poured into the frame. (Minke, 2006) It can be produced by hand in situ, but more industrialized and time-efficient methods have been initiated in the form of prefabrication (Rauch, 2015), and the usage of digital tools and robots in situ is currently under development (further discussed on page 36). Depending on wall thickness the finished wall must dry for 4-6 weeks before element prefabricated off site can be moved, which creates a need for weather-protected storage space. (Lehm Ton Erde, n.d)

### Local context

Excavated earth is considered waste material at construction sites for new infrastructure in Sweden. This is a material with huge logistical problems and a costly organization to remove both economically and environmentally. (Verdicchio, 2018) Initiating tests on earth excavated in Gothenburg has been done in previous master's theses at Chalmers University, showing potential in suitability for rammed earth, encouraging further testing. (Grunacker, 2021; Matsdotter, 2020)

By using this excavated waste material as a building material in nearby projects, the carbon footprint of the new infrastructure as well as of the newly erected building will be heavily reduced. The idea of temporary manufacturing facilities nearby major construction sites using the excavated earth to produce prefabricated rammed earth elements is an interesting concept. It could ease the implementation of rammed earth in a Swedish context and is further explored in this thesis.

## PURPOSE

Rammed earth is a material with excellent properties regarding sustainability, being indefinitely recyclable and with a very low embodied energy. It is locally available worldwide and historically one of the most used building materials. After the emergence of industrial conventional materials, earth was gradually phased out as a building material. Now it is reemerging in times of climate crisis as a sustainable alternative. Throughout history, knowledge was lost, and rammed earth now faces challenges to fulfill the strict building regulations of today adapted to fit conventional materials.

This thesis aims to investigate the limits and challenges of implementing rammed earth in a Swedish context today.

## RESEARCH QUESTIONS

- Q1 What are the obstacles in implementing rammed earth in a Swedish context?
- Q2 How can one through design overcome the limits of rammed earth in a Swedish context?

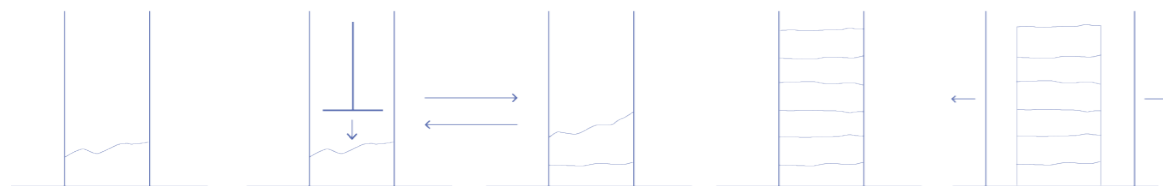

Figure 3. Ramming earth process. Earth is poured in to a formwork and compressed in different layers. Once a layer is compacted the formwork can be slid upwards to continue the ramming process.

## I. Introduction

### METHOD

The method for this master thesis is research for design.

#### Part 1. What are the limits?

Through literature studies, the limits of implementing rammed earth in a Swedish context are identified. The study is categorized into four topics, building law and regulations, climate, costs, and knowledge. They are researched one by one and reflected upon individually as well as together.

#### Part 2. Overcoming the limits.

In this part, the proposed solutions in part one are further researched in relation to design. Simple erosion tests are made to make statements about the impact of wind-driven rain and its design impact. To solve the problem of erosion, various weather-protecting solutions to avoid exposed rammed earth are explored.

Further on the design restrictions of transport in the case of prefabrication are investigated, as well as the methods for aesthetical assembly.

#### Part 3. Application.

The findings of previous parts are tested in a redesign of an already existing project. Different design solutions are explored and evaluated in comparison to the original design and the limits identified in part 1.



Figure 4. Method overview.

### DELIMITATION

This thesis focuses on the limits which can be overcome by design. Other challenges like exact calculations of mechanical resistance are outside the field of architecture and out of the scope of this master's thesis.

Swedish laws and regulations are explored to the level of BBR and EKS. More detailed classification systems with exact calculations are not inside the scope of this thesis. The feasibility of rammed earth within the confines of Swedish laws and regulations is based on theoretical findings.

The impact of the Swedish climate is based on comparisons of historical weather data from Gothenburg and locations with known rammed earth projects and similar climates. Research in the field of the impact on the erosion process caused by wind-driven rain is very limited. Based on available theory and simple testing, informed assumptions of the erosion process are made. More exact testing and research are needed but outside of the scope of this thesis.

Exploration of the economy is based on comparing the cost of different wall types today and researching the future prospect of rammed earth as a viable building material.

Due to a wide range of variations of climate in Sweden. Gothenburg is exposed to very intense wind and rain, making it interesting to study.

Stabilizers can be added to the earth mixture to achieve new properties, although the starting point of this thesis is that additives disturb the sustainability aspect and are not needed. Therefore, details about different kinds of stabilizers are outside the scope of this thesis.



Figure 5. Delimitation diagram, topics outside of the large rectangle are out of scope in this master's thesis.

## II. WHAT ARE THE LIMITS?

This part is where the limits of implementing rammed earth in a Swedish context are investigated and identified. The limits are categorized into four topics found relevant for this thesis: building laws and regulations, climate, costs, and knowledge.

All topics are explored separately and together. The conclusion is that rammed earth with varying properties depending on the source is hard to approve according to Swedish building requirements, the impact of the Swedish climate with extreme weather conditions is unsure, it is labor-intensive and therefore very expensive and there is a lack of knowledge in the field. Most of these challenges could be solved by implementing prefabrication and weather-protecting solutions to avoid exposed rammed earth walls, especially in more prominent weather directions.

CHAPTER OVERVIEW

When researching rammed earth it soon became clear that it is a sustainable building material facing challenges with acceptance all over the world. These challenges could be narrowed down to five categories; building laws and regulations, climate, costs, knowledge, and perception. In general rammed earth faces challenges to fulfill overly strict building regulations adapted to more conventional materials like concrete. Rammed earth walls exposed to rain will erode, to what is considered an acceptable extent and its impact is being debated. The number of rammed earth manufacturers is few, and the manpower demand is high causing prices to rise even though the material cost is extremely low. Lack of experience is another challenge to overcome, making it hard to find constructors willing to take on the job. Perception is another topic not covered by the scope of this thesis, nevertheless, it

is an important factor in the implementation of earth as a building material. Demand on the market is important for the implementation of rammed earth in Sweden to be successful.

These categories are explored one by one in this chapter to determine the potential of rammed earth in a Swedish context. Below is a diagram showing how challenges, from all categories explored in this chapter, can be sorted into two solutions, erosion protection and prefabrication.

Limits categories

- 1. Building laws and regulations
- 2. Climate
- 3. Costs
- 4. Knowledge
- Perception (out of scope)

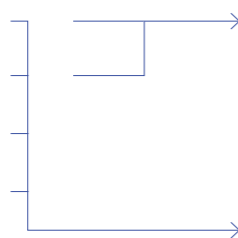

Analysis

- Erosion protection**
  - 1. Earth faces challenges to fulfill Swedish requirements, especially the question of durability.
  - 2. Swedish climate is challenging with strong winds and rain.
- Prefabrication**
  - 1. Enables a monitored testing system to ensure good standard.
  - 2. No need to adapt to weather during construction.
  - 3. More efficient and less in situ manpower means less costs.
  - 4. Standardized system eases spread of knowledge.

Figure 6. Diagram showing how the explored limits categories can be sorted into two main solutions.

SWEDISH BUILDING STANDARDS AND REGULATIONS.

Swedish building regulations are governed by the parliament and by Boverket, an authority appointed by the parliament. The system is divided into three parts with varying detailing.

PBL – Concluded by the parliament. Requirements are primary and briefly described.  
 PBF – Concluded by the parliament. Requirements are further specified but still not detailed, refers to the authority Boverket.  
 BBR – Concluded by Boverket. Requirements are fully elaborated. Regulations regarding mechanical resistance and stability are explained in EKS. (Boverket, 2022a)  
 These requirements must be fulfilled when changing or constructing a new building. (Boverket, 2022c)

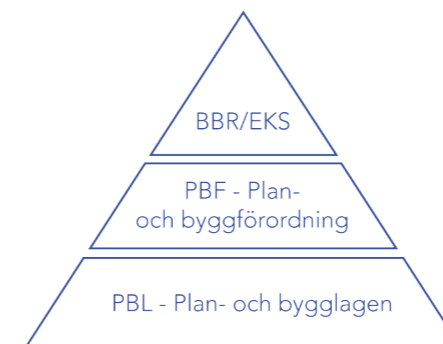

There are eleven technical construction requirements to fulfill to get a permit to build in Sweden. These are stated in PBL (2010:900) 8 kap. 4§ and further defined in BBR and EKS. (Boverket, 2022a) EKS compiles the Swedish version of the Eurocodes, which are the specified technical rules of how to conduct a construction works within the European union. (European Standards, 2022)

Technical construction requirements:

1. **Mechanical resistance and stability. (bärförmåga, stadga och beständighet)**
2. **Fire safety. (säkerhet i händelse av brand)**
3. **Protection with regard to hygiene, health and the environment (skydd med hänsyn till hygien, hälsa och miljön)**
4. **Usage safety (säkerhet vid användning)**
5. **Noise protection (skydd mot buller)**
6. **Energy efficiency and thermal insulation (energihushållning och värmeisolering)**
7. Suitability for the intended usage (lämplighet för det avsedda ändamålet)
8. Accessibility and usability for persons with reduced mobility or orientation skills. (tillgänglighet och användbarhet för personer med nedsatt rörelse- eller orienteringsförmåga)
9. Water and waste management (hushållning med vatten och avfall)
10. Broadband connection (Bredbandsanslutning)
11. Electric vehicle charging (laddning av elfordon).

(Boverket, 2022b)

Marked in bold text are the requirements found relevant in the exploration of using excavated earth as a building material in a Swedish context.

Swedish regulations and rammed earth

Below are the relevant required properties of building materials in Sweden listed in relation to the advantages of rammed earth stated by the rammed earth manufacturer Lehm Ton Erde (n.d.). All construction requirements in the diagram are linked to the advantages of rammed earth found relevant for each requirement. Most of the advantages are related to one of the required properties, making rammed earth seem like a material with great potential. However, some properties are not covered by any of the advantages, making these interesting to explore further.

The lack of relating advantages to property 4 (usage safety) could simply be explained by usage safety not being relevant to material choice, which was later discovered during the research phase. Usage safety is more about assuring minimized risk of falling, slipping, and electrical shocks among other things, which are generally more related to other factors than the building material. This leaves property 1 (mechanical resistance and durability), which after further investigations accurately seems to be the most challenging one to fulfill.

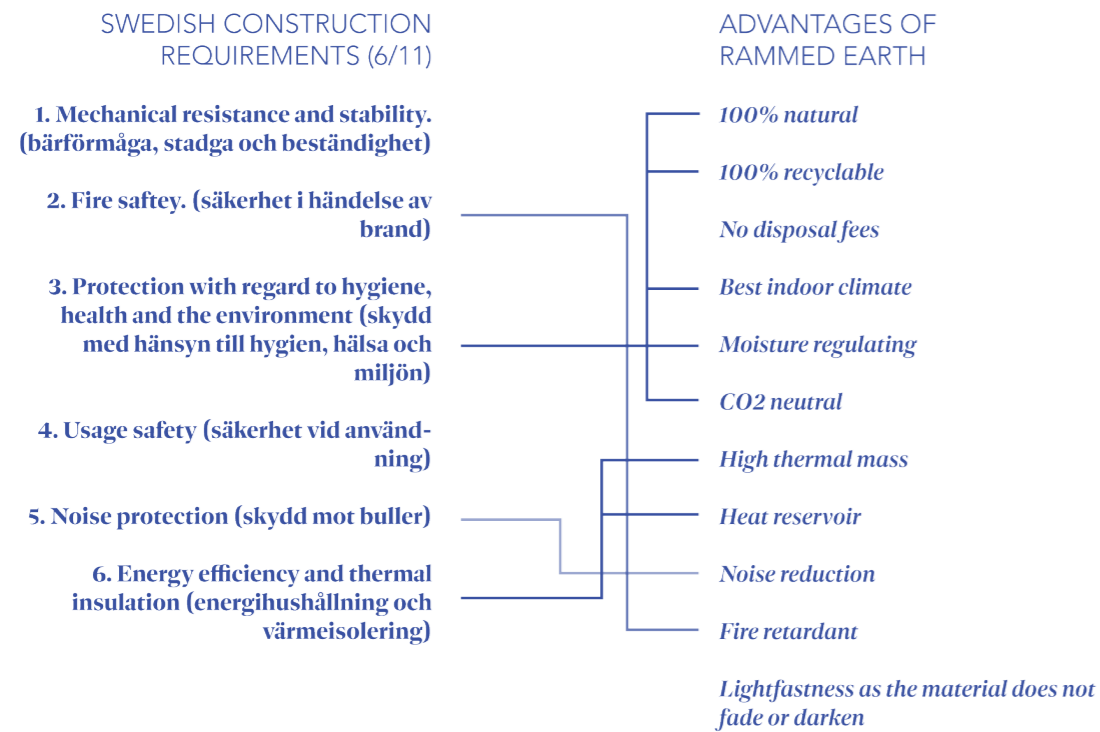

Figure 7. Swedish construction requirements linked to relevant advantages of using rammed earth stated by Lehm ton Erde (n.d.).

Requirement diagram

Below is a diagram showing the main challenges in approving rammed earth as a building material according to the relevant building requirement specified in Figure 8. The closer to the center of the diagram the more challenging the requirement

seems. Enhanced is the area in need for further investigation when trying to approve rammed earth as a building material in a Swedish context.

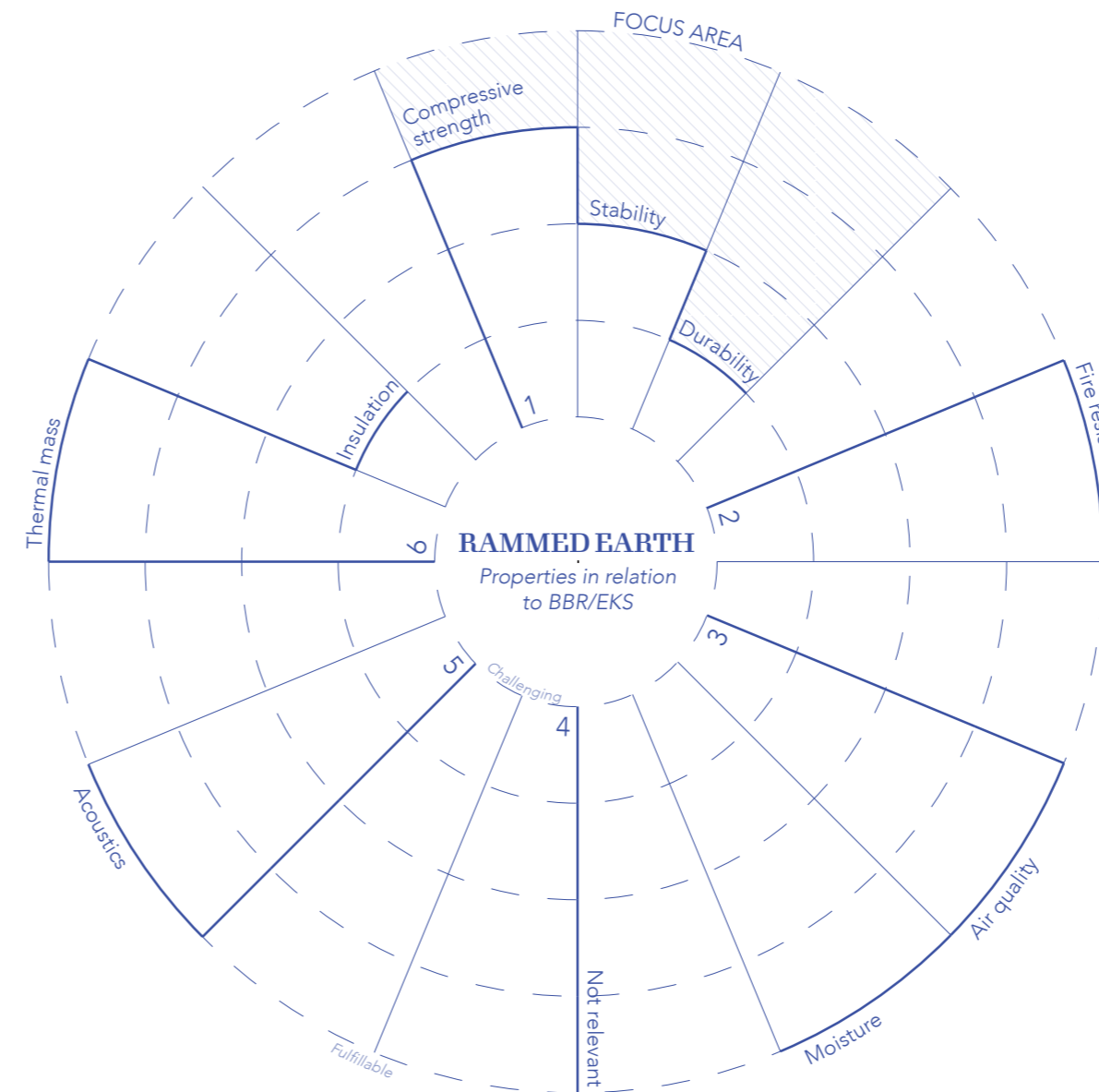

Figure 8. Showing how rammed earth fulfills the relevant technical construction requirements, where technical requirement 1 is the most challenging. Based on the table on page 26-27.

Laws and regulations overview

The following table shows an overview of the Swedish technical building requirements, next to theoretical findings on rammed earth properties relating to each requirement. A further elaborations can be found in the appendix.

To summarize the challenges of implementing rammed earth in a Swedish context, based and laws and regulations, the approval process would probably be eased by prefabrication or the usage of earth from one source for a big quantity of buildings.

PBL	PBF	BBR/EKS	Theoretical findings	Approvability																
<p>1. Mechanical resistance and stability. (bärförmåga, stadga och beständighet)</p>	<p>1. That the construction work collapse, fully or partly.  2. Unacceptable deformations.  3. Damage to parts of the construction work, its installations, or other fixed types of equipment caused by deformations in the load-bearing construction.  4. Damage, not in proportion to the incident.</p>	<p><b>Load bearing capacity</b>  Construction works and their partitions must possess a loadbearing capacity equal to or greater than the impact of loads during their usage and construction.</p> <p><b>Stability</b>  Construction works and their partitions must hold sufficient stability.</p> <p><b>Durability</b>  Construction works partitions and materials in a load-bearing structure must be durable, naturally or by interventions and maintenance ensuring durability during its lifetime.</p> <p><b>Materials</b>  Materials used in load-bearing structures must hold known, appropriate, and documented properties relevant for their use.</p>	<p><b>Compressive strength</b>  Rammed earth performs very well in compressive strength if the mixture is correct and the wall is protected from standing water, even without stabilizers.</p> <p><b>Stability</b>  Rammed earth faces some challenges with instability, especially in areas with the risk of seismic damage. In Sweden stability can easily be solved with a stabilizing ring beam at the top for example.</p> <p><b>Durability</b>  Water is problematic and causes erosion, especially in Sweden where facades are exposed to heavy wind and rain. In Gothenburg rain contains salt, which impact is debated in the field and considered unsure.</p>	<p>Desired load-bearing capacity and stability shouldn't be a problem to achieve if the content is carefully controlled. It could be approved with the system described in point d, below, monitoring and carefully checking the product in the context of a factory.</p> <p>Construction products with evaluated properties are products produced to permanently constitute construction works. They must either be:</p> <p>a) CE-marked,  b) type-approved according to 8 chap. 22-23§ PBL,  c) approved by a certification body or  d) be produced in a factory, continuously monitored, controlled, and approved by a certification body.  (EKS)</p>																
<p>2. Fire safety. (säkerhet i händelse av brand)</p>	<p>Requirement relevant for material:  The construction works, in the case of fire, can endure a certain amount of time.</p>	<p>The fire resistance of material should be documented according to a chapter in EKS, the Swedish standardization of the Eurocodes.</p> <p>EN 13501 is a European standard given the status of a national standard.</p>	<p>There are examples of rammed earth passing tests for European standards regarding fire regulations. Samples perform differently depending on the mixture, a general approvement is therefore hard.</p>	<p>The way current laws and legislation are formed makes it hard to standardize a material with varying properties depending on the mixture. Testing the fire resistance of building material is very expensive and not affordable to perform in each project with a new excavation site. The process of approving the material might be more feasible in the context of prefabrication, using the same earth for multiple projects. Test results are then applicable for bigger quantities.</p>																
<p>3. Protection with regard to hygiene, health and the environment (skydd med hänsyn till hygien, hälsa och miljön)</p>	<p>Avoid risking the health of users and neighbors, caused by any of the following:</p> <ol style="list-style-type: none"> <li>Emittance of toxic gases</li> <li>Toxic particles or gases in the air</li> <li>Dangerous radiation</li> <li>Contamination or empoisonment of water or ground.</li> <li>Lacking gray water-, smoke- or waste management</li> <li>Water damage in the construction works.</li> </ol>	<p><b>Air quality</b>  The building and its installations should be designed to enable good indoor air quality.</p> <p><b>Moisture</b>  The building should be designed to avoid water damage, odors, and microbial growth causing health issues.  Buildings, construction products, and materials should be weather protected during the construction phase and controlled for water damage.</p> <p>The climatic barrier should be airtight to avoid water damage caused by moist convection.</p>	<p>Rammed earth does not cause any health issues during any phase of its existence.</p> <p><b>Air quality</b>  Rammed earth has a very good impact on indoor air quality, mitigating heat as well as regulating moisture.</p> <p><b>Moisture</b>  Rammed earth has the property of regulating moisture by absorption and desorption, which creates good air and inhibits fungus growth. This property must be considered when designing the wall. Vapor barriers can be problematic, locking the moisture inside the wall.</p>	<p>If stabilizers are avoided and the wall is properly constructed, rammed earth walls can be safer than conventional walls with regards to hygiene, health, and the environment.</p>																
<p>4. Usage safety (säkerhet vid användning)</p>	<p><b>NOT RELEVANT</b></p>																			
<p>5. Noise protection (skydd mot buller)</p>	<p>The construction works must be designed with an acceptable noise level for users as well as people nearby. Noise must not impact health negatively.</p>	<p>Minimum sound reduction from one room to another (<math>D_{nT,w,50}</math>), for dwellings must be at least 52 dB measured from space outside of the dwelling to the inside.</p>	<p>Rammed earth is a heavy material which is good for acoustic insulation. The variation in surface texture additionally reduces the reverberation time and absorbs noise.</p>	<p>Rammed earth has good acoustic properties, fulfilling this requirement should not be a problem.</p>																
<p>6. Energy efficiency and thermal insulation (energiushållning och värmeisolering)</p>	<p>Requirements regarding renewable energy sources, enabling good energy management, and a climatic barrier ensuring good thermal properties.</p>	<p><b>Required U-values:</b></p> <table border="0"> <tr> <td>Small buildings</td> <td>0.30 W/m²K</td> </tr> <tr> <td>(ranging from &lt;50 - &gt;130m2)</td> <td></td> </tr> <tr> <td>Multiple dwelling houses</td> <td>0.40 W/m²K</td> </tr> </table> <p><b>Specific required U-values:</b></p> <table border="0"> <tr> <td>Wall</td> <td>0.18 W/m²K</td> </tr> <tr> <td>Roof</td> <td>0.13 W/m²K</td> </tr> <tr> <td>Floor</td> <td>0.15 W/m²K</td> </tr> <tr> <td>Window</td> <td>1.2 W/m²K</td> </tr> <tr> <td>Door (exterior)</td> <td>1.2 W/m²K</td> </tr> </table> <p>The climatic barrier must have good airtightness in relation to the chosen ventilation system to ensure good airflows and minimize the risk of water damage.</p>	Small buildings	0.30 W/m²K	(ranging from <50 - >130m2)		Multiple dwelling houses	0.40 W/m²K	Wall	0.18 W/m²K	Roof	0.13 W/m²K	Floor	0.15 W/m²K	Window	1.2 W/m²K	Door (exterior)	1.2 W/m²K	<p><b>Thermal mass</b>  Rammed earth performs very well as thermal mass, mitigating thermal changes in the building.</p> <p><b>Thermal insulation</b>  Rammed earth must be complemented with insulation materials to fulfill the requirements of thermal insulation in Sweden.</p>	<p>Additional insulation must be added to the wall composition to fulfill the demand for energy efficiency and thermal insulation, causing very thick walls.</p> <p>The thickness of the walls must be considered during the design to ensure good daylight, simultaneously, it can be used for sun shading.</p>
Small buildings	0.30 W/m²K																			
(ranging from <50 - >130m2)																				
Multiple dwelling houses	0.40 W/m²K																			
Wall	0.18 W/m²K																			
Roof	0.13 W/m²K																			
Floor	0.15 W/m²K																			
Window	1.2 W/m²K																			
Door (exterior)	1.2 W/m²K																			

*Further elaborated in appendix.*

### Summary

Swedish building laws and regulations are vague, and exact requirements are not set. Properties of the desired final performance are described, like a good indoor climate, how to reach it is not specified and neither is the question of what a good indoor climate is.

As the diagram (see Figure 8 on page 23) indicates, based on theoretical findings in relation to Swedish laws and building regulations, there is reason to believe that most construction requirements are fulfillable.

Some requirements like fire safety and mechanical resistance/stability differ depending on building typology. There are higher demands on fire safety in a public building due to less expectations on orientation ability among the users. The same applies to mechanical resistance and stability, where the damage caused by deformation is assumed more fatal in a public building than in a small-scale residential building.

Even though public buildings might generate a greater impact on increased knowledge among a bigger group of users, implementing rammed earth as an approved building material in the housing sector could be an easier first step. There is a huge need for new housing, making it relevant to invest in this field. Focusing on the housing market makes it more available to private customers and the advantage of a good indoor climate is very relevant in homes where a lot of the time is spent.

The uncertainty in fulfilling the Swedish construction requirements lies in requirement 1, mechanical resistance and stability. Properties like compression strength should not be a problem. The challenge is the system of approval, varying earth mixtures make it hard to achieve a general approval of rammed earth as a building material. One way to solve this is careful monitoring and frequent testing of everything in production, which can be organized in situ or preferably in a prefabrication factory to ease the process.

The question of erosion is another uncertainty when trying to approve rammed earth as a building material in a Swedish context, which is further explored in the upcoming pages.

### CLIMATE

Rammed earth is generally more known for its usage in dry and warm climates. Sweden is cold with a lot of rain and wind, making it interesting to investigate the impact of the local climate. There are examples of rammed earth standing the test of time in countries like Germany (see Figure 10) with a more similar climate to Sweden. This section looks deeper into the impact of rain and wind and makes comparisons to other known projects with similar climates.



Figure 10. Haus Rath, Germany. 6 storey loadbearing rammed earth and timber construction, built around 1850. (Escobar, 2013)



Figure 11. Horyuji Temple, Japan. At least 1300 years old rammed earth structure. Standing the test of time. Photo: D. Henman

**Erosion**

When exposed to rain, especially wind-driven rain, rammed earth faces challenges with erosion. Since raw earth is not water-resistant rain softens the surface and particles wash off, causing erosion. (Rauch, 2015) There are discussions within the field whether this is a problem or not, with existing examples of rammed earth buildings like Horyuji Temple in Japan lasting for at least 1300 years (see Figure 11). In general, rammed earth does face problems with fulfilling regulations adapted to conventional industrial materials, it is particularly failing in durability tests. Therefore, the use of raw earth has gradually been abandoned for stabilized earth, losing all environmental benefits. Even though there are several studies stating these tests as too severe and unrealistic. A study on durability for different mixtures of rammed earth walls, with and without stabilizers was made near Grenoble in the French alps (see Figure 12). These wall samples were provided with a roof and a water-resistant base and exposed to natural weathering for 20 years. After 20 years they were all still standing and the measured erosion depth for unstabilized rammed earth was about 6.4 mm. (Bui et al., 2009)

Even though regulations are very strict on erosion, unlike other more conventional materials, rammed earth can stand it. According to the conclusions of the durability study (Bui et al., 2009), a generic rammed earth wall of about 500mm thickness can stand an erosion depth of 10% while maintaining a safety factor of at least 2.7. Aesthetically an erosion depth of 5% is acceptable, which means an erosion depth of 25mm. As mentioned earlier the mean erosion depth 20 years after construction was 6.4mm, the erosion process is thought not to be linear and expected to slow down with time, which gives an idea of the life expectancy.



Figure 12. Test site for rammed earth wall samples near Grenoble in the French alps. The top images is an unstabilized rammed earth sample facing west. (Bui et al., 2009)

**Comparing climates**

To make statements about the impact of the climate on rammed earth in Sweden, other locations, with known projects in exposed rammed earth, have been chosen to make a comparison (see Figure 16 on page 32). The chosen reference project is Haus Rauch, the private home of Martin Rauch in Schlins (see Figure 13), and the test site in the French alps used to measure the erosion depth of rammed earth after 20 years of weather exposure, further described on the previous page.

**Rain and temperature**

Rain and temperature in Gothenburg (Figure 17), Schlins (Figure 18), and the test site are comparable. Temperatures are very similar, but the rain is heavier in Schlins as well as at the test site. Based on these factors alone, there is reason to believe that rammed earth can be implemented in Gothenburg.

**Wind**

Wind speeds in Gothenburg are very strong compared to sites with similar climates and exposed rammed earth structures (see Figure 14). Though the wind speeds of the erosion test site in France are comparable with wind speeds up to 75km/h (Bui et al., 2009) in relation to maximum speeds of 61km/h in Gothenburg. The amount of windy days at the test site is not known, but the fact that exposed rammed earth can stand climates with sometimes stronger winds than in Gothenburg is interesting. When wind speeds exceed the terminal velocity of the raindrop, there is a risk that vertical surfaces are more exposed to rain than horizontal surfaces like the roof (Osterling, 2022). There is a study made on clay from demolished earthen buildings of the Fujian Tulou in China. The purpose of the study is to test the durability caused by wind-driven rain. It shows a peak in erosion depth at a rain inclination angle of 15-30 degrees. (Luo et al., 2020) This is interesting to consider when designing rammed earth buildings at locations with intense wind.



Figure 13. Haus Rauch, Schlins, Austria. (Bühler, n.d.)

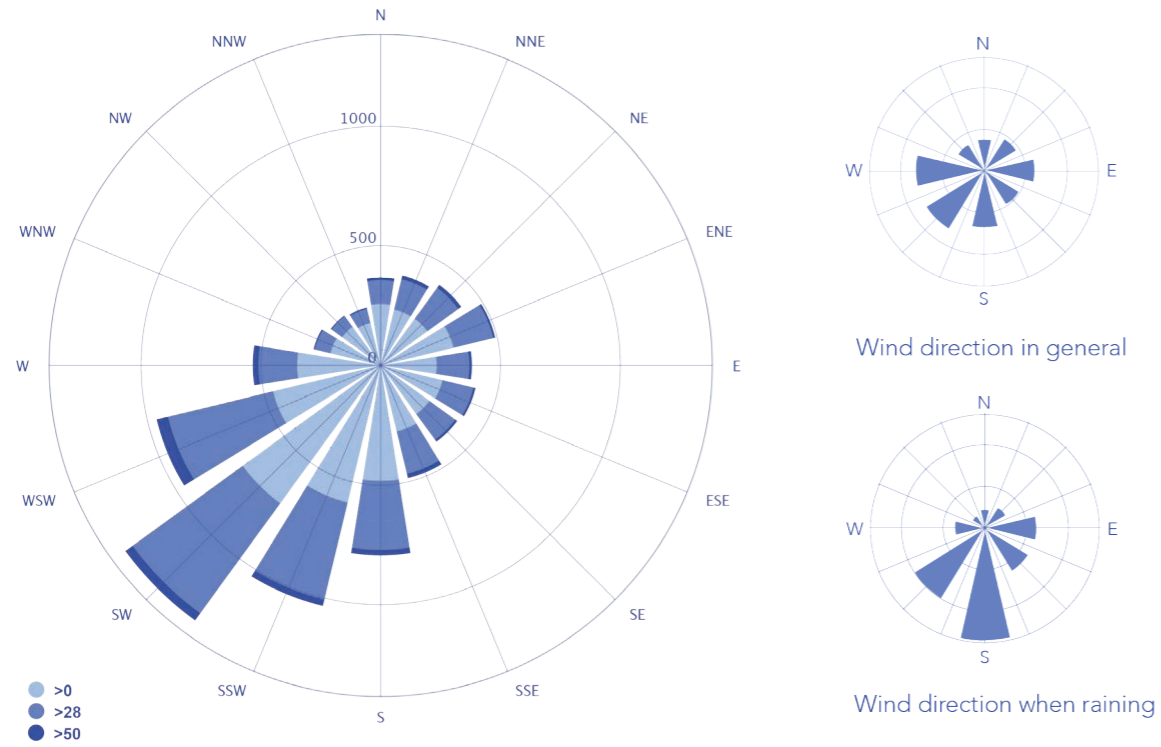

Figure 14. Average wind speed, direction and hours year 1985-2015 in Gothenburg. Wind roses to the right are difference in when it's raining in Måseskär, Bohuslän. (Adapted from Meteoblue, 2022 and SMHI, 2022)

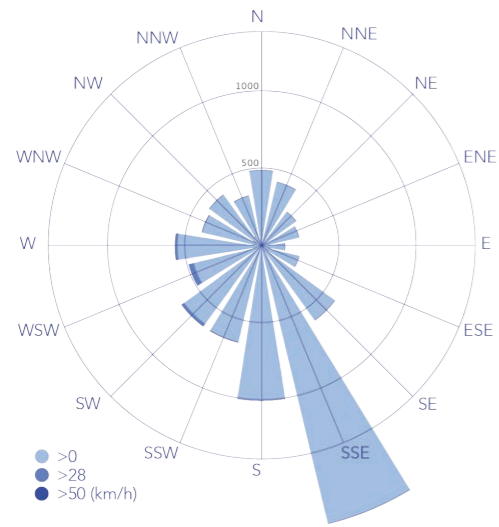
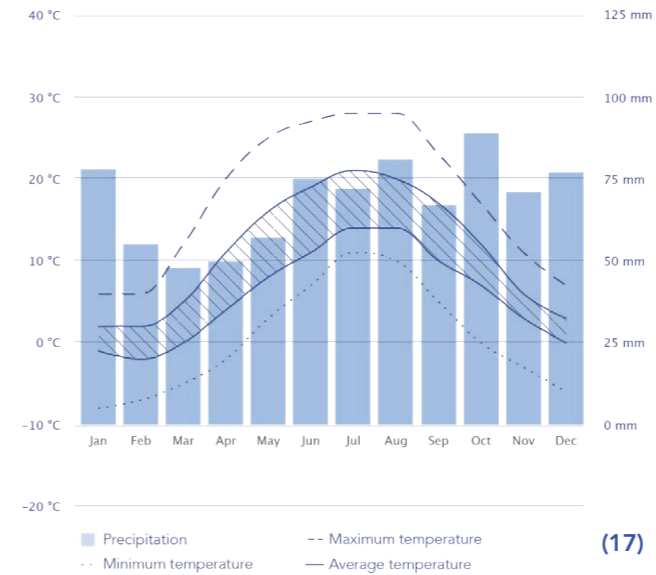

Figure 15. Average wind speed, direction and hours year 1985-2015 in Schlins, Austria. The location of Haus Rauch. (Adapted from Meteoblue, 2022)



Figure 16. Locations of comparison.



(17)

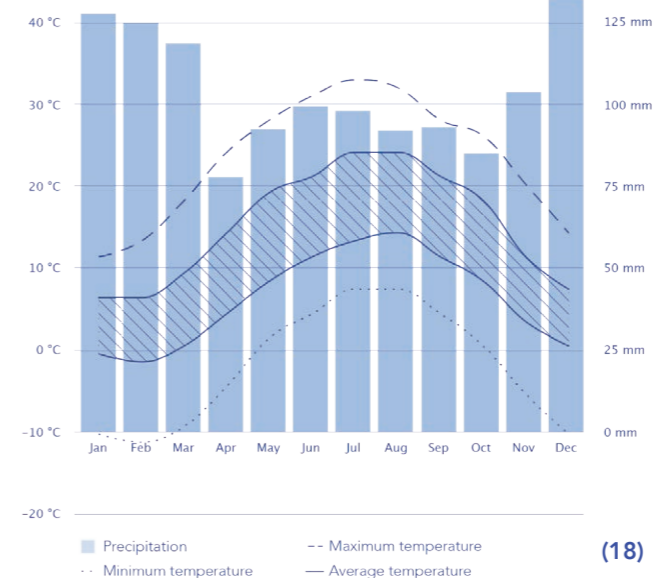

(18)

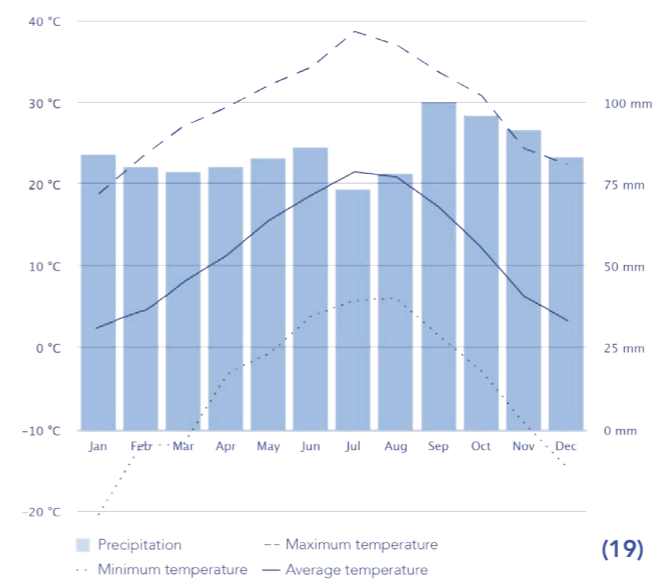

(19)

**Comparison**

Schlins in Austria where Rauch House is situated, as well as the test site in France, have very similar weather properties regarding temperature and precipitation, compared to Gothenburg in Sweden (see Figure 17, Figure 18 and Figure 19). The amount of rain is heavier in Schlins and at the test site, though the wind is much heavier in Gothenburg than in Schlins, but comparable to the test site.

Even though it is raining less, the strong winds in Sweden are likely to cause almost vertical rain which speeds up erosion.

From WNW to N, the number of windy days is more in Schlins (see Figure 14 and Figure 15), this could be interpreted as a direction that would be safe to have exposed rammed earth walls. Since it is not exposed as frequently, though the winds are stronger in Gothenburg, which in combination with rain could be a greater problem causing the erosion process to speed up. As mentioned under erosion (on the previous page), erosion depth is causing aesthetic issues before it is causing constructional ones. After 20 years the erosion depth is less than 25% of the aesthetically acceptable depth at the test site in France. Since the erosion process is expected to slow down, it is possible to argue for a long life expectancy of exposed rammed earth in Sweden. Though there is still uncertainties due to the unknown frequency of windy and rainy days at the test site.

Figure 17. Average temperature and precipitation in Gothenburg, year 1985-2015. (Adapted from Meteoblue, 2022)

Figure 18. Average temperature and precipitation in Schlins, year 1985-2015. (Adapted from Meteoblue, 2022)

Figure 19. Temperature and precipitation on erosion test site. (Adapted from Bui et al., 2009)

**BUILDING COSTS**

This chapter discusses the viability of rammed earth from an economical point of view. Figure 20 shows the construction and material cost of conventional walls used in Sweden next to the cost of rammed earth walls today. The cost difference is considerable, leading to questioning if rammed earth can become economically feasible in a Swedish context.

**Conventional walls**

Numbers are taken from a bachelor thesis at KTH (Pettersson & Olsson, 2019) on request of WSP Sverige AB, and confirmed by M, Bergström, group manager at WSP (personal communication, March 10, 2022). Since 2019 when the calculations were made there has been an increase of costs due to inflation, with at least 6,6% which has been added to the numbers.

**Light wall**

- a Steel and mineral wool construction with external plaster covering.
- b Steel and mineral wool construction with brick facade.

**Heavy wall**

- c Concrete structure with external plaster covering.
- d Concrete structure with brick façade.

**Rammed earth wall**

- e Erde wall, rammed in situ by Lehm ton Erde.
- f Erde wall, prefabricated by Lehm ton Erde. Finished wall, based on assumed help from costumer with seamless finishing. The finishing stands for one third of the cost.
- g Test wall, rammed in situ. Preschool Hoppet in Gothenburg.
- h Cost of excavated earth in situ/from urban construction sites.

**Rammed earth wall**

The numbers on these walls are based on data from Mikael Åberg visiting the Erden office in Austria, communicated through Earthlab (personal communication, February 15, 2022). Most of the Erden walls, by Lehm ton Erde, are implemented in projects in Switzerland, which is a country with very high building expenses, making these numbers a bit exaggerated in a Swedish context.

Even though the material cost is very low, at least when using waste earth or earth excavated in situ. The method is very labor-intensive and manpower is very expensive in Sweden. It is not yet a conventional method and constructors with the right knowledge and experience are rare. The test wall (g) was part of a research project in collaboration with Earthlab at Chalmers University and was constructed in situ at preschool Hoppet in Gothenburg, Sweden. The cost is an estimation made by the constructor, based on his first time constructing a rammed earth wall. This cost can be expected to decline with time and increased experience and routines, and even more by implementing non-manual ramming methods. The cost of this test wall should rather be viewed as the maximum cost of a rammed earth wall in Sweden.

Even with an experienced team like with the Erden walls, ramming in situ is very expensive and not feasible in economically restrained projects. Prefabricated Erden walls are almost half the price, and almost one-third of this cost is in situ manpower making seamless joints (see Figure 34 on page 48). Solving these joints in another less time-consuming way would drastically reduce the cost.

The earth imagined to be used in the context of this master thesis is locally sourced in situ or from nearby construction sites with excavated "waste" earth, without cost (h).

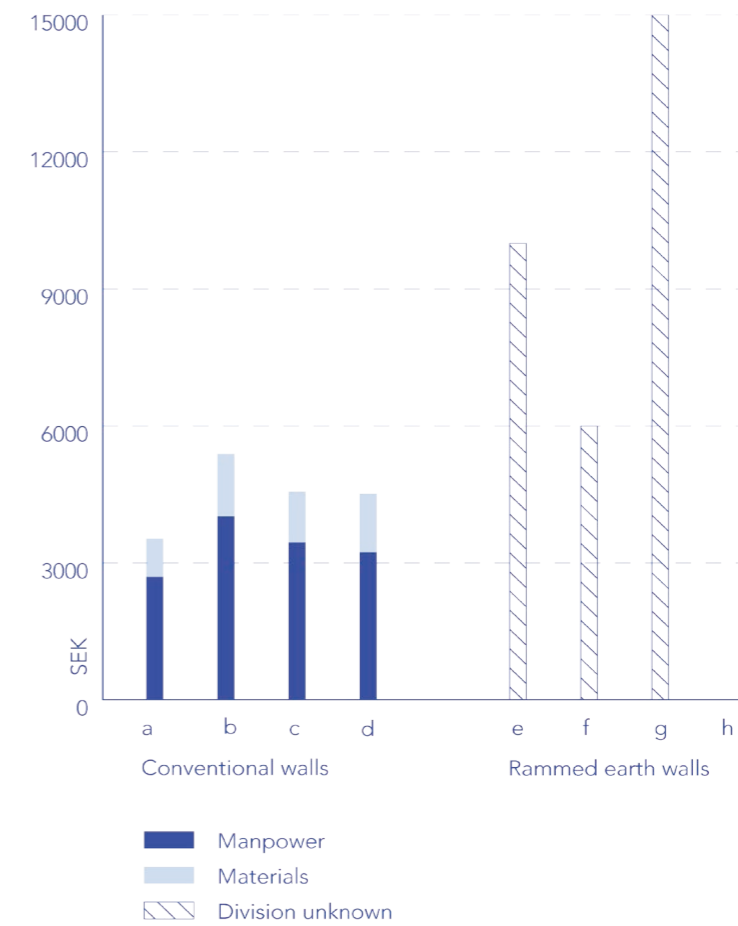

Figure 20. Cost conventional versus rammed earth walls (Pettersson & Olsson, 2019; Earthlab. Personal communication, February 15, 2022)

### Economical viability

Currently rammed earth is very expensive only available for a few unless it is made in the context of self-building cutting the manpower cost. With only a handful of manufacturers on the market, there is the risk of the demand exceeding the supply causing the prices to rise. Even if this would not be the case, rammed earth is still considered an unconventional method, making it hard to economically compete with industrial materials. A more sustainable future society has the potential to place rammed earth in a new more competitive position in relation to the conventional materials, with heavy environmental footprints, used today. Following are some possible aspects of how rammed earth can become more economically viable.

#### Transport and waste costs.

New infrastructure investments in big cities often generate loads of earth considered waste material, which must be handled. The new metro Västlänken in Gothenburg is alone estimated to generate 3,3 million cubic meters of excavated land masses wherefrom 1,77 million cubic meters are earth masses, which all together equal 940 000 transports of waste material. (Verdicchio, 2018) In the private building sector, the estimated fee to leave land masses at a landfill is about 1300-1600kr/truck, additionally, there is a cost of about 600-800kr/hour for transporting the material. (Micke, 2018) The landfill fee is in the case of Västlänken paid by the state (Verdicchio, 2018), a cost that could be heavily reduced by seeing it as a resource and allowing rammed earth manufacturers to handle the material.

#### Carbon tax

Already back in the 1920s, Sweden implemented an energy tax, and more recently in 1991, a carbon tax was implemented. This type of tax is economically pushing for a sustainable change based on the "polluters pay"-principle. The tax level has been gradually increased to allow households and businesses to adapt and give time for behavioral and systematic change. (Sweden's Carbon Tax, 2022) By constant increment of the carbon tax level, a certain level will be reached when materials with very low embodied energy, like rammed earth, will become economically competitive.

### Circularity

The Waste Framework Directive, part of the European Commission, set a target for a minimum of 70% recovery of construction and demolition waste (C&DW) by the year 2020 in Europe. In 2016 many countries had implemented markets for recovered C&DW and the target of recovering 70% was already reached. These high recovery rates can be explained by using the waste material for backfilling and low-grade recovery, not closing the circular loop. ("Construction and Demolition Waste," 2020)

In a world with limited resources, circularity is crucial. The market for secondary materials is lagging, virgin materials are still cheaper, and their material quality is assured through warranties and standards. Finding ways to make secondary materials more economically competitive with assured quality is necessary for a circular building sector. As of today, the economy is still linear assuming materials to be easily available and cheap to dispose of. (Construction and Demolition Waste: Challenges and Opportunities in a Circular Economy, 2020)

In the future, materials likely require the possibility of reuse and recyclability, heavily economically dependent on the secondary value of the material. In this scenario rammed earth becomes very competitive, being endlessly reusable without loss of quality and a low embodied energy.

#### Automated manufacturing processes

New more time-efficient methods for ramming earth are interesting in making rammed earth more economically viable. An automated manufacturing process is currently under development at the Institute of Structural Design at the TU Braunschweig, specifically looking at robots with sliding formwork and automatically poured earth. Contrary to concrete, there is no chemical reaction needed to activate the binding force using earth. Rammed earth is stable as soon as it is compacted, and the formwork is only needed in the compression moment. Each compacted layer using this robot is much thinner than traditionally manual ramming methods, differentiating this method aesthetically from traditional rammed earth walls. ("Robotic Fabrication", 2019)

Using this new technique would drastically increase the construction speed from 20-30h/m<sup>3</sup> of manual ramming to 8h/m<sup>3</sup>, which is predicted to increase even more. Additionally, no time or material cost is needed to construct a formwork, using this new method. ("Robotic Fabrication," 2019)

### Summary

Rammed earth walls are currently very expensive, though there is reason to believe this will change in the future. New digitalized tools can reduce the production speed to less than one-third of the construction time needed today, which would drastically reduce the manpower cost.

Society must undergo an economic transformation to turn into a sustainably resilient society. In the future, virgin materials will be much more expensive making circular materials, like rammed earth, more economically competitive. Increased energy- and carbon taxes are to be expected which would further improve the economic situation of unprocessed materials, giving rammed earth a chance to become economically attractive.

## II. What are the limits?

### “WHAT ARE THE LIMITS?” CONCLUSION

Below is a diagram summarizing this chapter. Four main challenges have been identified when exploring the categories of limits, which are proposed to be solved by prefabrication and protection against weather and erosion. There are other complementary

solutions like economic funding, but these cannot be solved through design and are therefore not mentioned. Prefabrication and erosion protection are both interesting to explore further in relation to design.

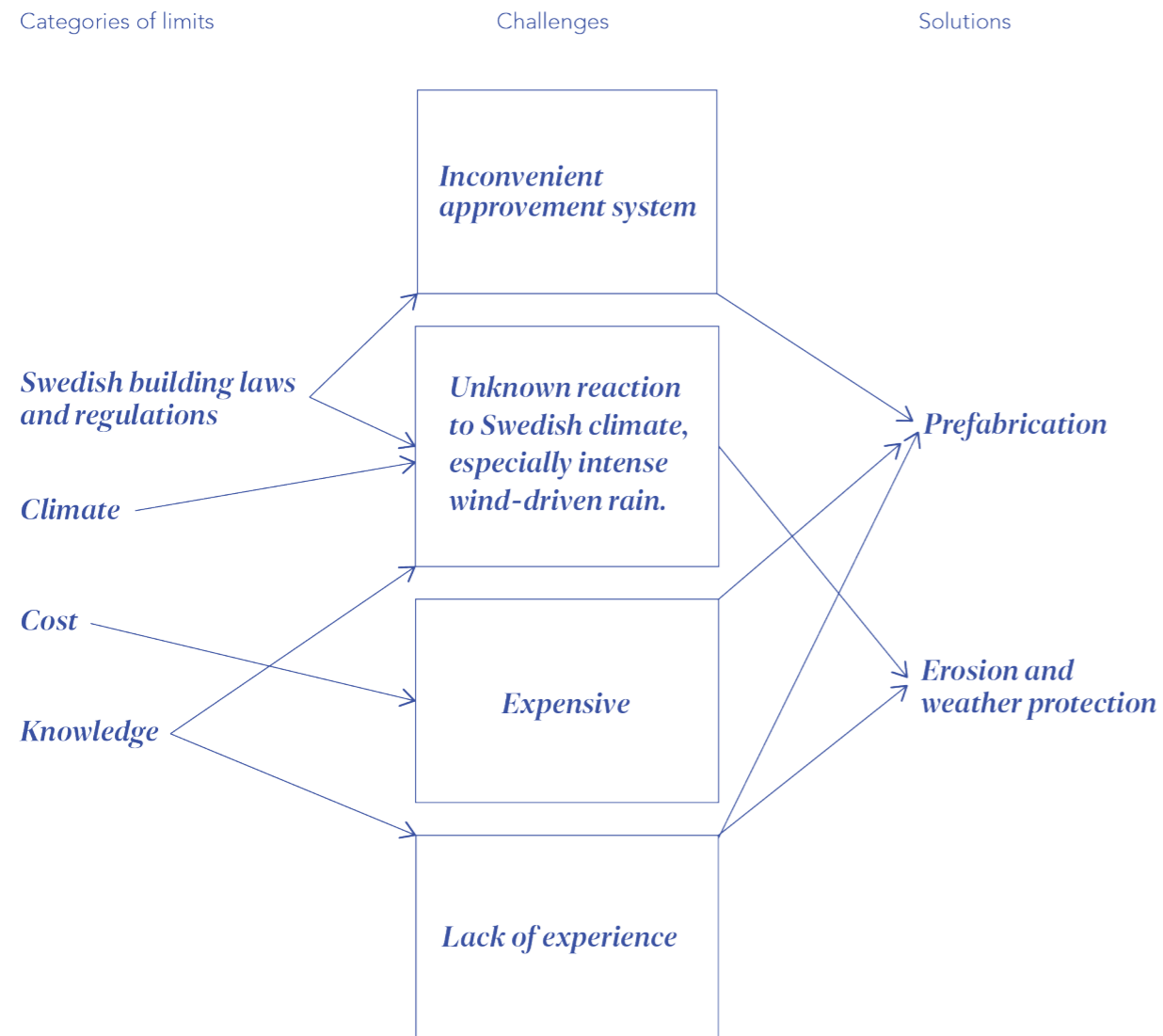

Figure 21. “What are the limits?” conclusion diagram

### III. OVERCOMING THE LIMITS

In this part erosion and prefabrication are further investigated in relation to design. Different solutions for weather protection are explored and rammed earth samples and simple erosion tests are made. This is to get a better understanding of the material and the aesthetical impact of erosion caused by wind-driven rain.

Looking into prefabrication, different methods of ramming are researched as well as the aesthetical challenge of joining the elements in situ.

### III. Overcoming the limits

## EROSION

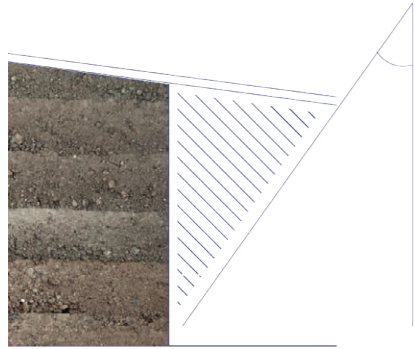

### Protection against erosion - Design strategies

Erosion can be considered a problem using rammed earth, though there are multiple ways of solving it. An array of solutions are proposed below.

#### Overhanging roof

An overhanging roof is a very common traditional solution to avoid erosion. Especially in locations where wind-driven rain is less common than in Sweden. The more extruding the more the façade is protected from wind-driven rain.

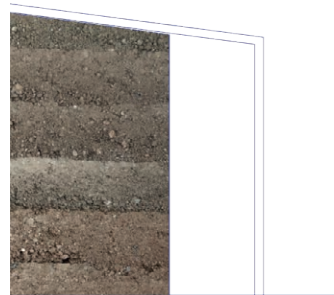

#### Double façade

An extra façade can be used to protect the earth, like the Reconciliation Chapel in Berlin with an external wooden structure distanced from the exposed rammed earth wall. A double façade could also be designed with an external glass façade, similar to a Trombe wall (explained on the opposite page).

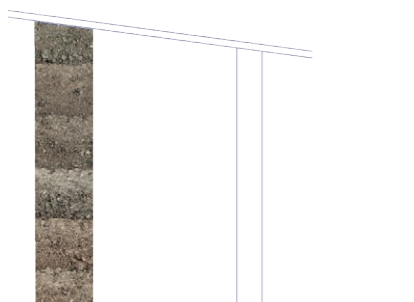

#### Interior usage

To provide thermal inertia and improved indoor climate in a building, rammed earth can be used for interior walls completely safe from erosion.

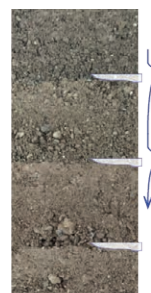

#### Erosion checks

Erosion checks can be used to slow down the erosion process. Differentiating water-resistant materials are placed close to the surface, at the beginning of each rammed layer, disturbing the water flow along the façade. Haus Rauch is designed using this strategy.



#### Trombe wall

Trombe walls are used to passively heat a building. A heavy wall, like rammed earth, is directed towards the sun for heat storage, covered with exterior glazing with a small amount of air in between. Air from the interior is let through a vent into the space in front of the heavy wall, as the air gets warmer it rises and is then let in again through a vent at the top. After sunset, all vents are closed, and heat absorbed by the massive wall is slowly released throughout the night, increasing the thermal comfort. (Hanania et al., 2015)



#### Calculated erosion

Exposed rammed earth walls are expected to erode. This can be considered when dimensioning the wall, adding extra thickness which is expected to erode.



#### Cladding

A solution to avoid erosion is to cover it with a cladding layer or water-resistant surface coating. This could be beneficial in cold climates where additional insulation is needed, thereby solving two problems at once by placing it on the outside behind the façade covering.



#### Additive/stabilizer

Resistance against erosion can also be achieved by adding stabilizers to the earth mix. This is not recommended in this thesis, since stabilizers usually compromise the environmental advantages of the earth.

**Erosion test**

The erosion process of a rammed earth wall exposed to wind-driven rain is stated not to be linear by multiple sources (Bui et al., 2009; Rauch, 2015) instead, it is expected to decline with time enabling so-called calculated erosion. This expectancy is considered self-evident in most reports without referring to any sources. No studies of the erosion process have been found during the research phase of this master thesis, making it interesting to test if the erosion process is linear or not.

Firstly, rammed earth wall samples are produced using the ball drop test to anticipate the right proportion of water and earth. These walls are then exposed to water, simulating wind-driven rain. The method of the erosion test is not scientifically correct and should be viewed as an exploration of the material behavior and its aesthetics.

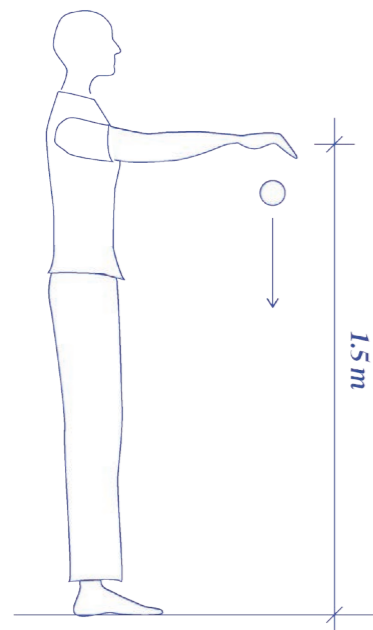

Figure 22. Ball drop test, dropping height.

**Ball drop test**

Ideal water content (IWC) during the ramming process is important and has a direct impact on the final strength of the rammed earth wall. With too little water the wall won't be properly compacted and with too much water, the water itself resists compaction. Depending on the earth mix the IWC will vary, making it important to know the material when working it.

The IWC can be checked by forming a ball, of about 4cm in diameter, with the earth mix and dropping it from shoulder height (~1.5m) on a flat surface (see Figure 22).

- If the ball stays together the mix is too wet. If the result persists even when it is dryer, it could also be a sign of too high clay content.
- If the ball breaks into many pieces the mix is too dry.
- If the ball breaks into only a few pieces, the water content is close to the IWC and appropriate for ramming.

This test should be continued throughout the ramming process to assure the quality of the finished rammed earth wall.

(Keable & Keable, 1996)

**Rammed earth test samples**

Reused dry rammed earth mix with excavated clay from Gothenburg was borrowed from Earthlab, a research group at Chalmers University. Based on the given recommendations (A, Sigurjónsson, personal communication, February 23, 2022), water was added to the mix and allowed to soak for 24 hours before ramming.

The earth was rammed into the frame to the right, using a wooden club by hand. The wall sample was worked in thin layers of about two centimeters before compacting.



Figure 23. Mixture 1, too dry mixture, due to misunderstanding recommended water content. Ball drop test not possible. 1:10 relation of water and rammed earth mix. Rammed sample is very fragile.



Figure 24. Mixture 2. More water was added to the original mix. Falling into pieces in ball drop test. 1:7 relation of water and rammed earth mix. More compact result with a better looking surface finishing.



Figure 25. Mixture 3. More water was added to the original mix. Cracks in ball drop test. 1:5 relation of water and rammed earth mix. More elastic mix, hard to make compact when ramming.

**Method**

The rammed earth samples described on the previous page are used in the test to study the erosion process. At this point, the samples have been drying for 8 weeks to ensure it is completely dry. Due to too small water content during the ramming process, mixture 1 has been excluded from the test.

Each test was divided into 8 showerings with constant horizontal water pressure made with a shower nozzle placed 35cm from the sample. The duration of each shower was the time it took to fill one bucket of water (10L). Between each session, the runoff water collected in the bucket was filtered through kitchen paper to gather the earth content.

All the saved runoff earth content was allowed to dry and then weighed to determine the erosion process.

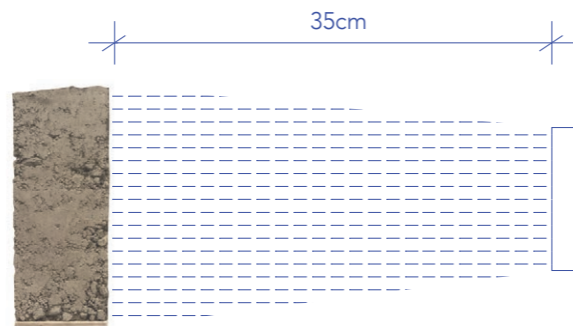

**Result**



Figure 26. Mixture 2, after 10 liters of water showering.



Figure 27. Mixture 3, after 10 liters of water showering.



Figure 28. Graph of the test results, showing the earth content fallen off at 10-liter intervals [g/liter]. Sometimes bigger gravel pieces fall off explaining sudden increases in earth content weight.

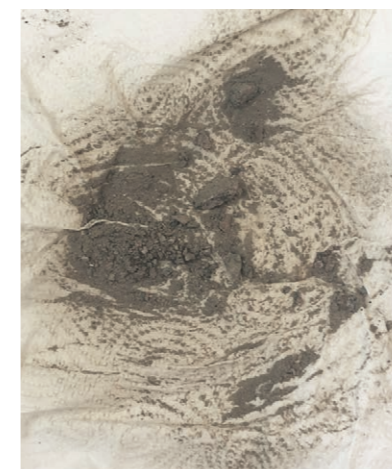

Figure 29. Mixture 2, after 70 liters of water showering.

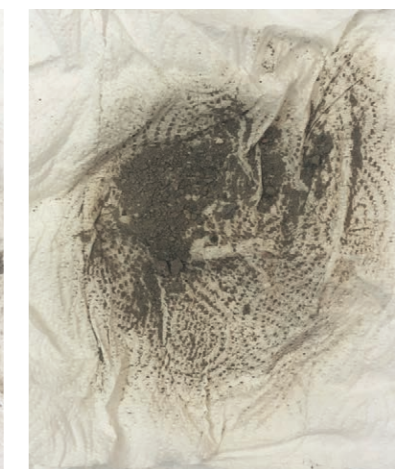

Figure 30. Mixture 2, after 80 liters of water showering.



Figure 31. Mixture 3, after 80 liters of water showering.

### Analysis

The main purpose of this test was to get a better understanding of the material. The test is not fully realistic with intense water pressure at a constant horizontal angle, and the walls were never allowed to dry between showers, which is not reflecting reality.

The extent of the test was limited, and the result would profit from more measured values, but based on the measurements made, the test shows a drastic decrease of eroded material in a very early stage. Sometimes bigger pieces fall off, causing the curve to temporarily change direction (see *Figure 28*, at 70L).

Wall mixture 2 was believed to be the most successful sample when ramming, with a relation of water and mixture closer to recommendations and an experience of it being easier to compact. Though in this test, wall mixture 3 performed better with less eroded material and thereby less impacted surface at the end of the test (see *Figure 28*). This can be explained by variations in the manual ramming process, with more or less compact layers and different thicknesses of each layer, which can explain the unexpected result.

The test shows the importance of correct mixture proportions and the ramming method. The difference in fallen-off content after the first showering is remarkable, both in weight (see *Figure 28*) and in visual appearance (see *Figure 26* and *Figure 27*). However, it is worth stressing that the decrease rate of mixture 2 is higher, and might reach the same erosion speed as mixture 3 later. Nevertheless, it is obvious that wind-driven rain will have a major impact on the appearance of the wall. *Figure 32* and *Figure 33*, shows the surface after 80L water has washed over both samples. Mixture 3 is more intact, however, the expected result of an exposed rammed earth wall should be closer to

mixture 2 at some point and the result could even be a more advanced version of the erosion process for mixture 2 in the long term. From an aesthetic view, this must be expected and accepted when deciding to make rammed earth walls exposed to the exterior.

Correct earth mixture and uniform ramming could be eased by prefabrication, which is further discussed in the upcoming pages.



Figure 32. Mixture 2, surface after erosion test.



Figure 33. Mixture 3, surface after erosion test.

## PREFABRICATION

Prefabrication is a very interesting topic, further discussed in this chapter. It reduces the production time as well as costs, which are prominent challenges when dealing with rammed earth. Ramming earth off-site was first done in the 1990ies but is still considered a largely unexplored topic. (Rauch, 2015) At the time of publication (Rauch, 2015) only single-leaf constructions had been prefabricated and mounted seamlessly in situ, cavity walls were under exploration then and are now offered as a product by Lehm Ton Erde, the office of Martin Rauch. Rauch is prominent on the market, both in sales and the research sector, allowing his method to become the basis of the entire field. Though there are competitors on the market, such as future robotic assistance (read more "Automated manufacturing processes" on page 36) and in situ prefabrication described below.

### Prefabrication method, Lehm Ton Erde:

One continuous wall is produced and cut into the correct length. They are all numbered for correct reassembly in situ, to make the horizontal rammed earth pattern aligned and achieve a monolithic appearance. In situ all pieces are mounted together, they are placed so that vertical joints are not aligned to increase stability. Cracks and voids are filled with matching loam and seamlessly hammered into place (see Figure 34). (Lehm Ton Erde, n.d.)

The size of a prefabricated element is determined by the lifting capacity of the crane used in situ both close to the crane and when being outreached. (Rauch, 2015)

### Prefabrication method, Nicolas Meunier:

Meunier has developed a mobile prefabrication module, used to prefabricate rammed earth blocks on the ground in situ. When still wet the formwork is removed and the block is lifted into place with a 2mm precision, reducing incidents such as rough edges caused during transport. After ramming the formwork is immediately removed and the block is lifted into place when it is still moist. (Lyon, 2019) This method requires in situ manpower, but the ground-based production makes it more time efficient, and less time and material is needed for the formwork, which can be reused for each block.

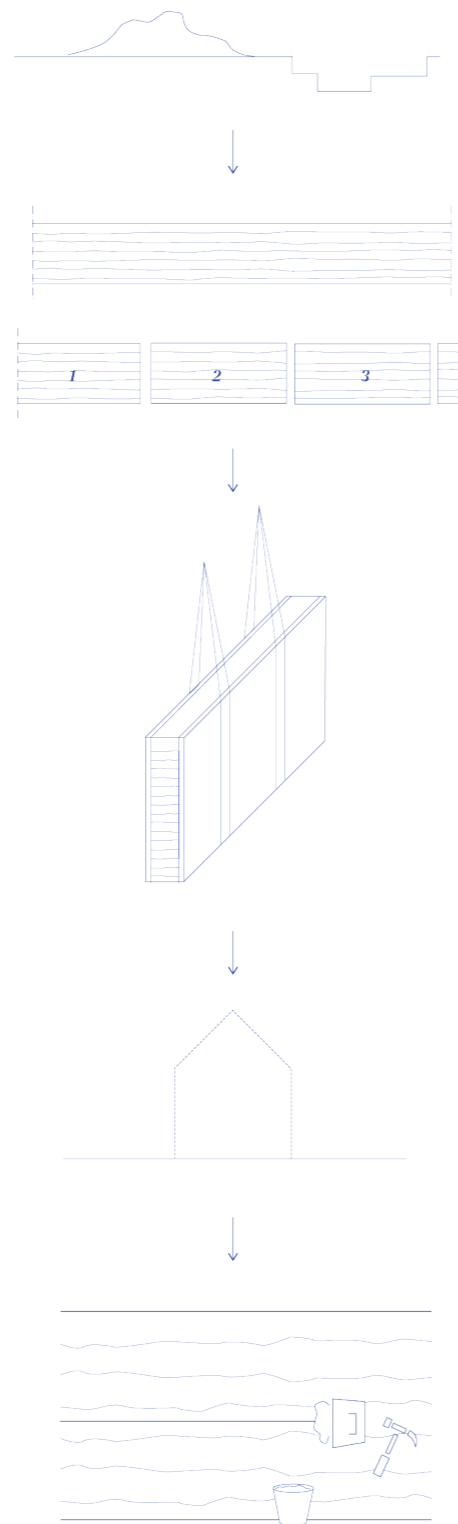

Figure 34. Prefabrication with seamless assembly in situ. One long wall is rammed and cut into pieces and numbered to be placed correctly in situ to achieve a continuous pattern. Joints are filled with matching loam and hammered seamlessly into place. (Based on Rauch, 2015)

### Transport

According to Trafikverket, Swedish transport administration, dimensions of a truck-loaded cargo should not exceed a width of 4.15m and height of 4.5m, even then special permission is needed. (Trafikverket, 2021) Limitations of prefabricated building element sizes are often determined by the lifting capacity of the crane used in situ, rather than maximum transport dimensions. Unloading and assembly in situ must be carefully planned considering lifting capacity, maximum outreach, and placement of the crane. For perspective, a mobile crane can have a maximum reach of 40m and a carrying capacity of 135 tonnes-meter (Sundbergs Åkeri AB, 2022), meaning a lifting capacity of 3.75 tons at 40m outreach.

### Stability challenges

Rammed earth elements lack tensile strength which must be considered when lifting heavy elements. Forces must be equally distributed along the lower edge of the element. At Lehm ton Erde, straps attached to the lifting equipment are placed a maximum of 60cm from one another. When ramming, wooden wedges are placed at the bottom, and later removed and replaced by lifting straps. (Rauch, 2015) Removing these wedges and straps in situ cause uneven element joints, which are made seamless with retouching of the surface (see Figure 34).

### Joints

Achieving aesthetical joints between prefabricated rammed earth elements is difficult since they are very fragile. This section is a reflection on different solutions, based on known examples as well as personal thoughts.

#### Separation

The number of joints could be minimized by intentional gaps between the elements, either left open or filled with elements like windows. This is applied in Figure 35 where vertical joints are avoided by allowing gaps in between the elements.

#### Seamless joints

Aiming to create a monolithic appearance, Lehm ton Erde has developed a method to seamlessly join prefabricated elements using earth to fill the voids (see Figure 36 and further description on page 48). This is considered an aesthetically pleasing solution, though it is time-consuming work, increasing the cost.

#### Almost seamless

Another way to achieve almost seamless joints has been performed by Nicola Meunier in France (see Figure 38). Meunier has developed a mobile prefabrication module, used to prefabricate rammed earth blocks on the ground in situ. When still wet the formwork is removed and the block is lifted into place with a 2mm precision. The fact that the element is still moist and short transport distances, rough edges are minimized. Thereby reducing the need for time-consuming retouching. The method Meunier use for retouching is simpler, leaving faded mark from the joint as an aesthetical feature. (Lyon, 2019)

#### Fine lines

Joints visible as fine lines could be hard to achieve, at least with big elements exposed to heavy forces when transported into place. With smaller elements, fine lines are achievable and aesthetically attractive (see Figure 37).

#### Hybrid

Prefabricated rammed earth elements could be used in combination with other materials, to express the joints. It could be a wooden or metallic structure either integrated into the structure to improve the tensile strength during transport or added as a surface layer in front of the joints.

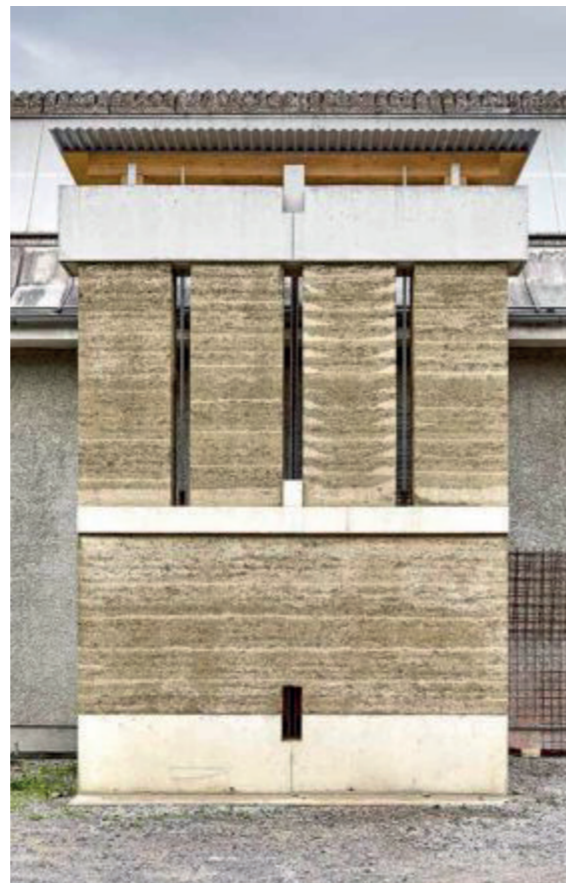
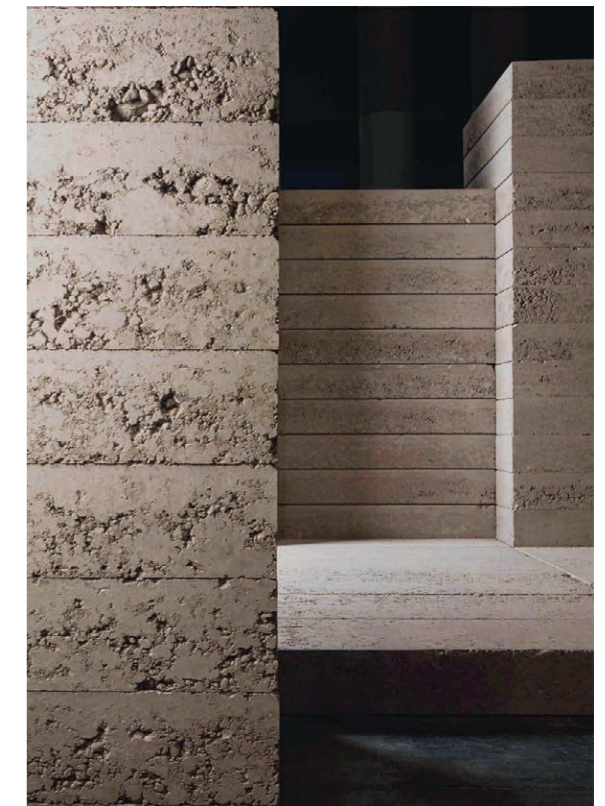
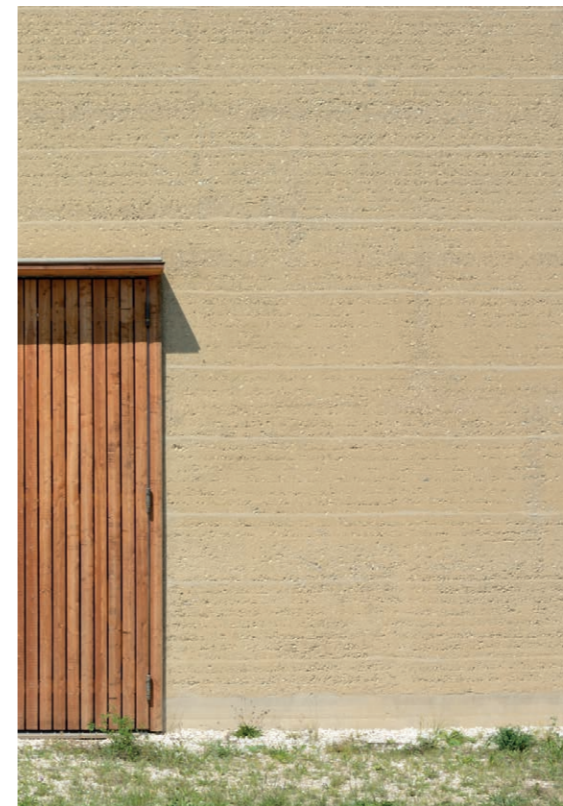

Figure 35. Above. Mock-up Sitterwerk, St. Gallen, 2017. Summer school organized by Roger Boltshauser. Upper elements are composed as prefabricated elements to save time. (Heckhausen & Hilgert, 2017)

Figure 36. Opposite page, upper left corner. Ricola Kräuterzentrum by Herzog & de Meuron. Prefabricated wall with seamless finishing, consulted by Martin Rauch. (Robert, 2013-2014). CC BY-NC-ND 4.0

Figure 37. Opposite page, upper right corner. Prefabricated rammed earth blocks with visible fine line joints, by Fetdeterra. (Fetdeterra, 2022).

Figure 38. Opposite page, lower image. L'Orangerie, Lyon, France. Office building made of prefabricated rammed earth blocks. (Fouillet, 2021)



### Summary

Traditional manual ramming won't be feasible when implementing rammed earth in a Swedish context. The construction of the formwork and the manual ramming process are too time-consuming. Modern methods have been developed and new ones are currently under development.

Future automated manufacturing processes are very interesting, with radically increased production speed. Each layer is much thinner than in traditional ramming, causing the appearance to change. The surface will likely become less lively, which is considered an aesthetical disadvantage. However, the surface can be enriched by pigmented layers.

In the nearby future prefabrication is more likely, either off-site or ground-based in situ to ease the construction process. Rammed earth elements are fragile, and transport can cause rough edges, which must be considered in the design and particularly in the placement of joints. Large prefabricated rammed earth walls are heavy and moving them will cause injuries. Ground-based prefabrication in situ is therefore interesting, with minimized transport distances and finer edges. Smaller elements like Fetdeterra (see *Figure 37*) can also be expected to be less injured during transport since they are easier to handle.

There are more or less time-consuming ways to join elements, which will impact the design and project budget. Seamless retouching is more time-consuming and not necessarily the most aesthetically attractive solution.

### OVERCOMING THE LIMITS

### CONCLUSION

There are many solutions to overcome the limits of rammed earth in a Swedish context through design. Worth stressing is that erosion will occur if rammed earth is exposed to the exterior and joints are likely to be visible. The material behavior will impact the appearance throughout its lifetime and through design it can be made beautiful.

### IV. APPLICATION

A few criteria were stated when searching for an object to redesign using rammed earth. This part starts with a description of these criteria and moves on to presenting the chosen object to redesign and a reflection of the choice.

Without changing the floorplan more than the wall thickness, rammed earth is integrated into the design. Step by step different parts of the building are detailly drawn to show how rammed earth can be used in a Swedish context. The design and this thesis, as a whole, are then evaluated in the concluding discussion.

## IV. Application

### CRITERIA

- Small- to medium-sized housing building.
- Min. two dwellings.
- Min. two floors
- Load-bearing façade.
- Within a radius of 160 km from the excavation site.
- Concrete structure.

*It is true that reinforced concrete (a brilliant late 19th-century invention whose energy consumption and pollution levels in the manufacturing stage have recently been slightly reduced) is vital to some public works and large buildings. However, it is worth stressing that in most homes and small to medium-sized buildings, it is perfectly possible to replace it with untransformed natural materials such as raw earth. (Dethier, 2020, p. 13)*

Relatively small concrete structures could easily be replaced by rammed earth and drastically reduce the embodied energy. It is interesting to keep this in mind even if not a high priority criteria for the redesign object of this master thesis. To narrow down the investigation of regulations, the choice has been made to focus on small to medium-sized housing units. There is a constant need for new housing in most big cities in Sweden. By proposing earth as a building material to meet this demand, the environmental footprint can be heavily reduced. The introduction of earth in the context of many peoples' everyday lives, can improve perception and knowledge of the material and increase the demand in the construction sector.

The purpose of making earth a conventional material is to increase the possibility of locally sourced materials in Sweden as well as in a more worldwide context. According to LEED materials are considered locally sourced when harvested within a radius of 160 km (LEEDuser, 2022). Which is interesting to consider when looking for a redesign object.

### VIADAL EKOBY (ECO-VILLAGE)

An ongoing project by Wingårdh Architects in Ödåkra outside of Helsingborg in Sweden. The site of the project is owned by a gardener who grew up there. The ambition is to create an eco-village with different building typologies focusing on reuse and gardening. Old as well as new greenhouses are used to enable farming around the year as well as a pleasant semi-outdoor climate.

1. Already a sustainability focus.
2. A shared interest in rammed earth from responsible architects as well as the client.
3. Different building typologies, making it possible to analyze implementation of rammed earth in multiple contexts.
4. Focus on cost-efficiency
5. Local nicely pigmented excavated earth from the manmade pond.

#### Building typologies

Viadal eco-village consists of different building typologies to welcome a more diverse group of people with different needs. Pre-conditions vary depending on typology, making the site very interesting when exploring the potential implementation of rammed earth in a Swedish context. Depending on the circumstances different solutions can be proposed, leading to an interesting discussion on the feasibility of rammed earth.

This master thesis is limited to focus on one of these typologies, the rowhouse. For now, 25 rowhouses are planned for the site, making prefabrication with local earth more economically feasible.

#### Rammed earth and greenhouses

As stated in previous chapters, intense wind-driven rain can be a problem when implementing rammed earth in Sweden. The combination of rammed earth and greenhouses is therefore very interesting. While the earth is completely weather protected, its properties as thermal and moisture regulators can improve the climate inside the greenhouse. >>

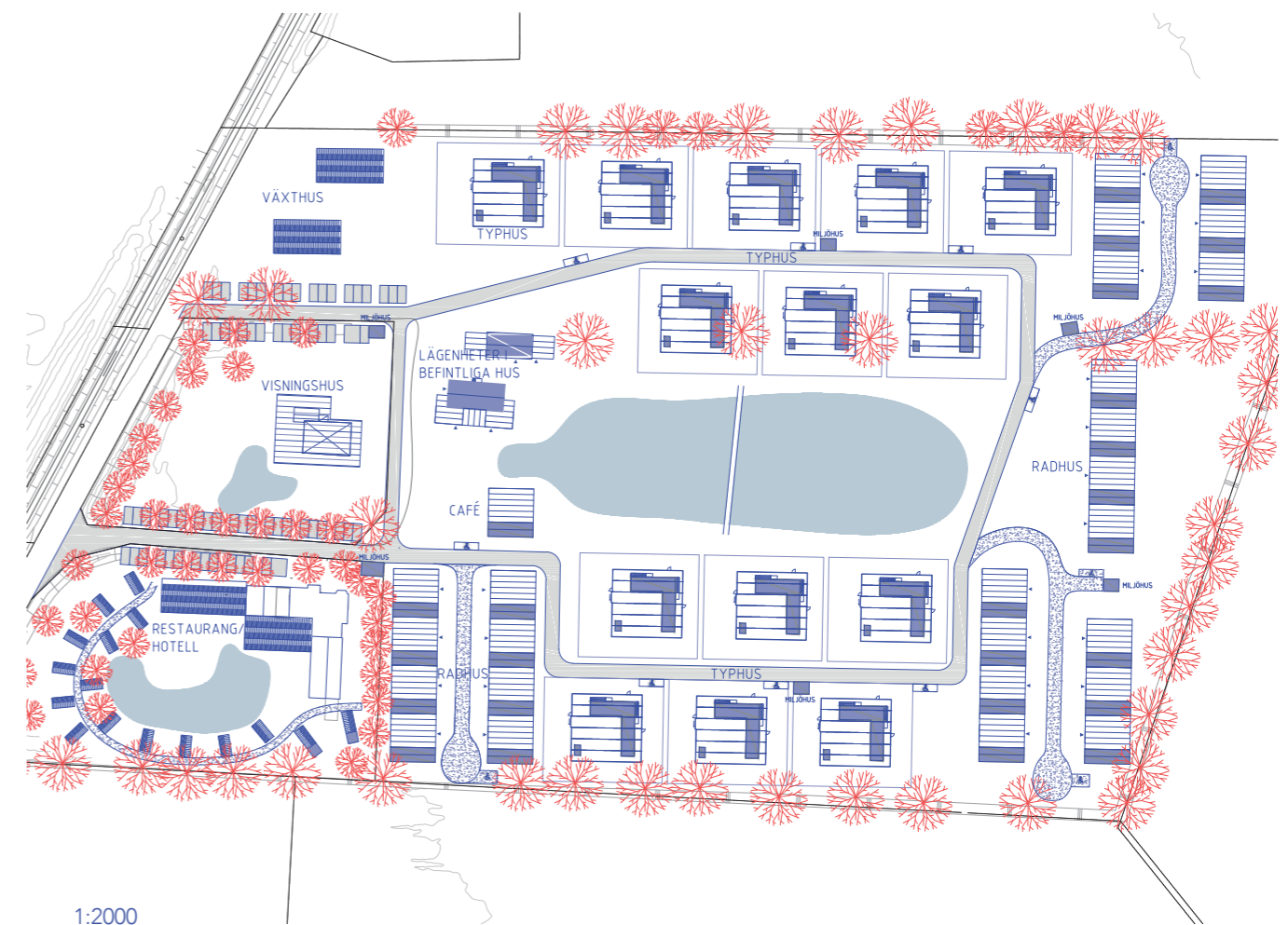

Figure 39. Viadal eco-village site plan, showing rowhouses and villas in combination with greenhouses.

#### IV. Application

» Homes in Sweden often have too dry indoor climate, which can be even more challenging when enclosing the building with a greenhouse. A lot of space for greenery is needed to keep a good moisture level inside the greenhouse, which is compromised by living spaces. (Granmar, 2021) Implementing rammed earth, regulating moisture, in this context could thereby be a good idea.

##### Chosen object reflection

The rowhouse fulfills most of the stated criteria. The original idea was to find a redesign object within 160km radius of Västlänken in Gothenburg, a construction site with loads of excavated waste earth. This would support the idea of organizing a temporary prefabrication factory next to a construction site of this scale. Though the scale of Viadal eco-village with 25 rowhouses would argue for the potential of implementing a smaller mobile prefabrication factory on site using local earth. In this way transportations of fragile earth elements are minimized, and time-consuming retouching might not be necessary.

Overall it is a small optimized design, with a greenhouse making it interesting to explore many different solutions within the same design.



Figure 40. Illustration of the rowhouse by Wingårdh Architects.

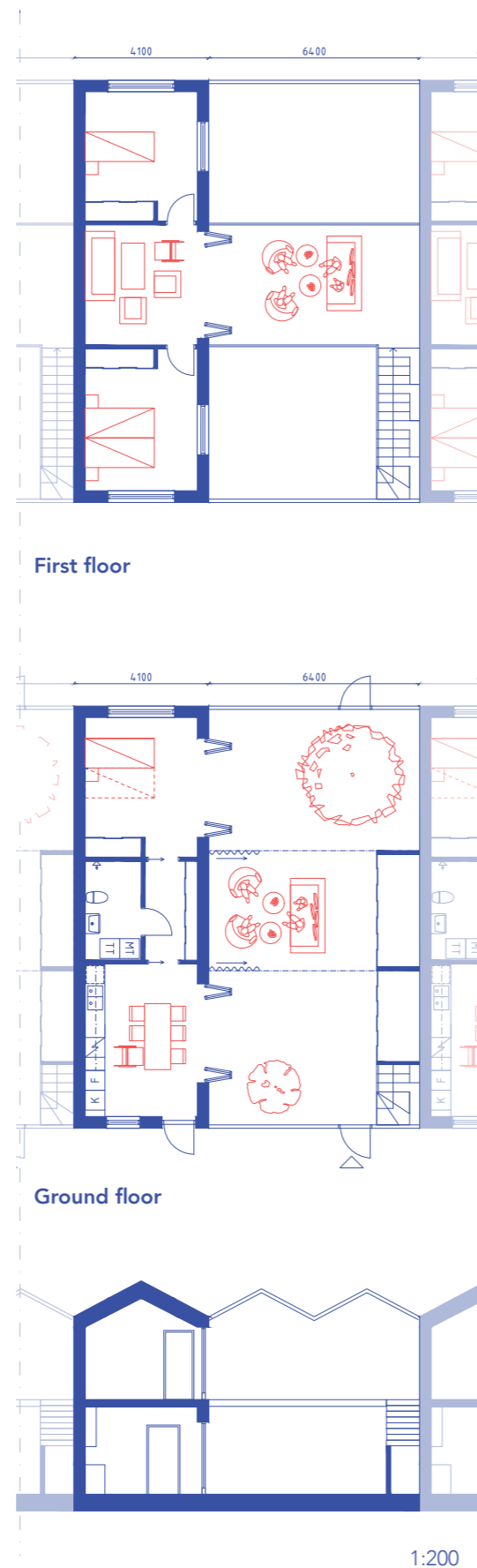

Figure 41. Original layout of the rowhouse.

#### The rowhouse

##### Original layout (Figure 41)

Old greenhouses from the site, previously used for farming, are reused in the design of the rowhouses. The project aims to be cost-efficient, welcoming people with different economical circumstances. Floor plans are very space effective, with an as little amount of heated space as possible. Communication and social spaces are focused in the private winter garden (greenhouse). There are walls both facing the semi-outdoor greenhouse and the outdoor exterior. The architecture is simple making it easier to enhance design impact of a redesign using rammed earth.

##### Adapted floor plan (Figure 42)

The wall thickness will increase using rammed earth. A thickness of about 30cm is needed to ensure the necessary stability and compressive strength. When implementing rammed earth in a cold climate like Sweden, additional insulation is needed to provide a good and energy-efficient indoor temperature, which almost doubles the depth of the wall.

To the right is the adapted floor plan with thicker walls. Some openings are angled to provide better light situation. The shading inside the walls show the placement of rammed earth, depending on the properties of the walls the earth is placed differently in relation to the insulation. This is described in detail in the following pages.

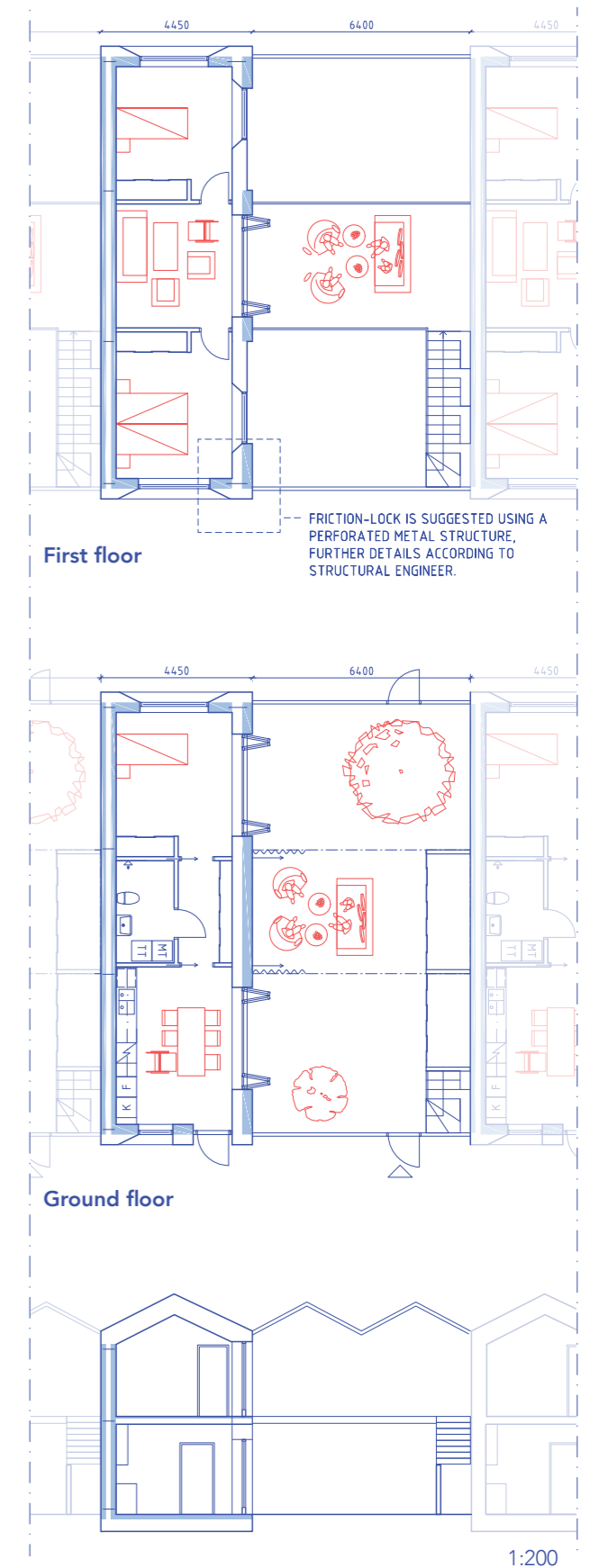

Figure 42. Adapted layout of the rowhouse. Light blue shading shows the placement of the rammed earth.

#### IV. Application

##### Rowhouse in pieces

To better understand the building, its parts are described piece by piece in this section.

##### Exterior facades

Erosion must be carefully considered since facades towards the exterior will be exposed to weather, such as wind-driven rain. This could be done either by calculating and slowing the erosion process or by completely avoiding exposure of the rammed earth towards the outside.

##### Floors

The thermal inertia of rammed earth can be used efficiently by using rammed earth screed as flooring. Big floor surfaces are exposed to heat radiation from the sun during the day, mitigating the temperature difference when the sun is gone. Due to the high density of rammed earth, it performs very well in terms of acoustic isolation and allows the floor structure to be thinner than a wooden structure with the same acoustic properties.

##### Separating wall

This is the dwelling separating wall, facing the neighbor's greenhouse. For aesthetical and acoustical reasons this wall is proposed to be built as a cavity wall with rammed earth exposed on both sides, even though it is a bit more time consuming. The cavity stops material borne sound to transfer from one dwelling to another and by placing the insulation in the middle the aesthetically pleasing rammed earth surface is exposed both in the interior and inside the greenhouse.

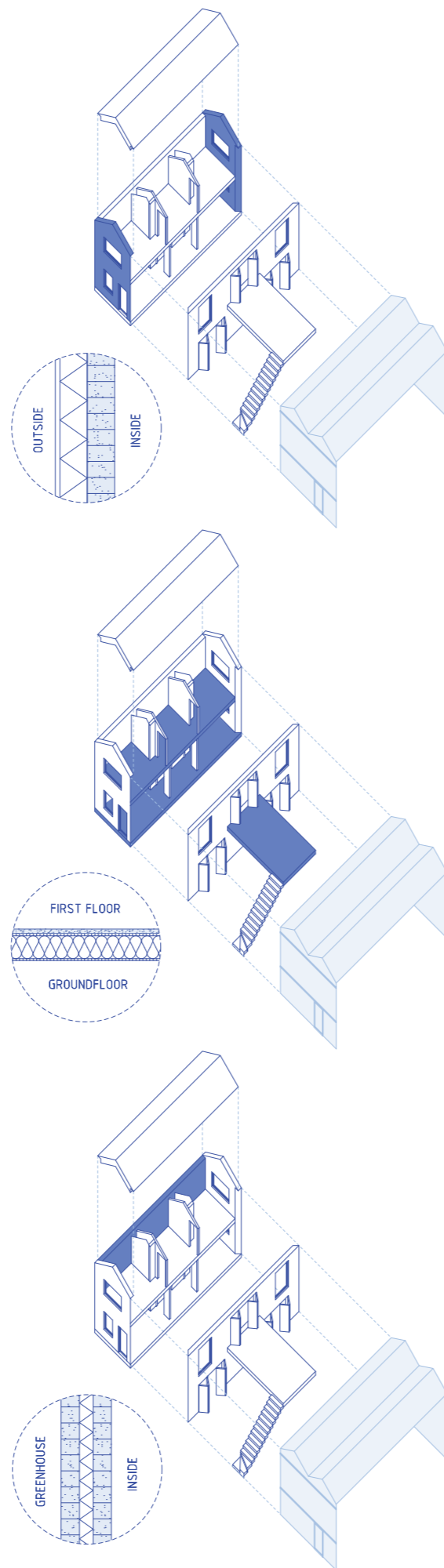

##### Greenhouse wall

The greenhouse wall is the wall with openings facing the greenhouse. An architectural quality in this project is the possibility of opening up the indoor living areas towards the greenhouse during warmer seasons, minimizing the boundary between indoors and outdoors. To do so, big opening are planned with spans of 3 meters, which is challenging to solve with rammed earth with almost no tensile strength. To simplify the construction, avoid overly expensive reinforcement solutions, and tell the true story of the material, these spans are covered by a wooden construction. Below is an elevation drawing showing the rammed earth divided into three parts with a wooden construction in between.

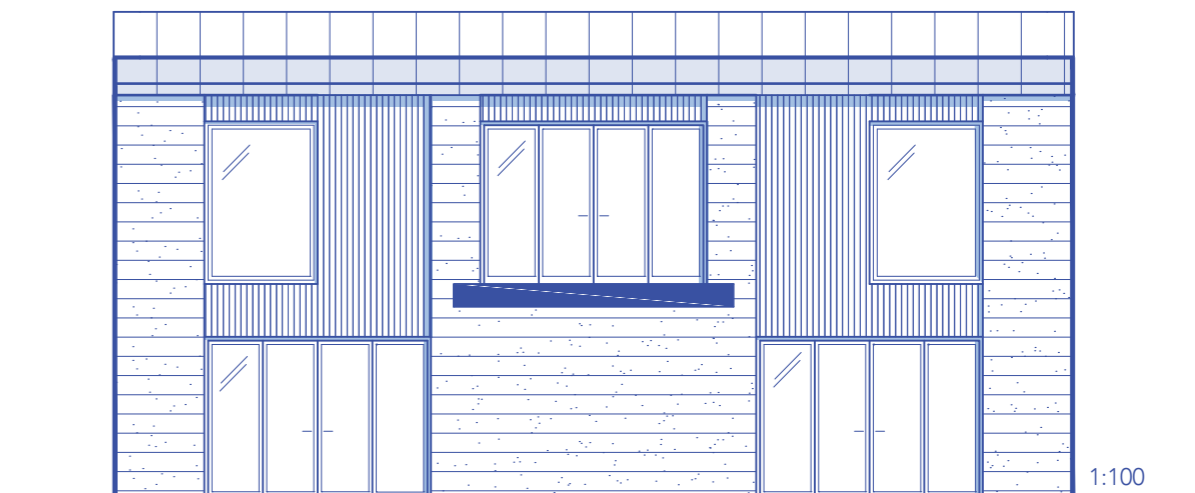
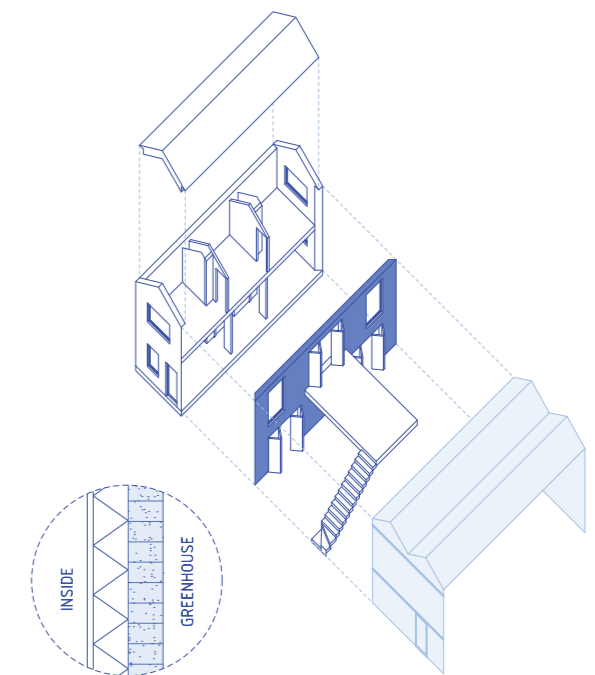
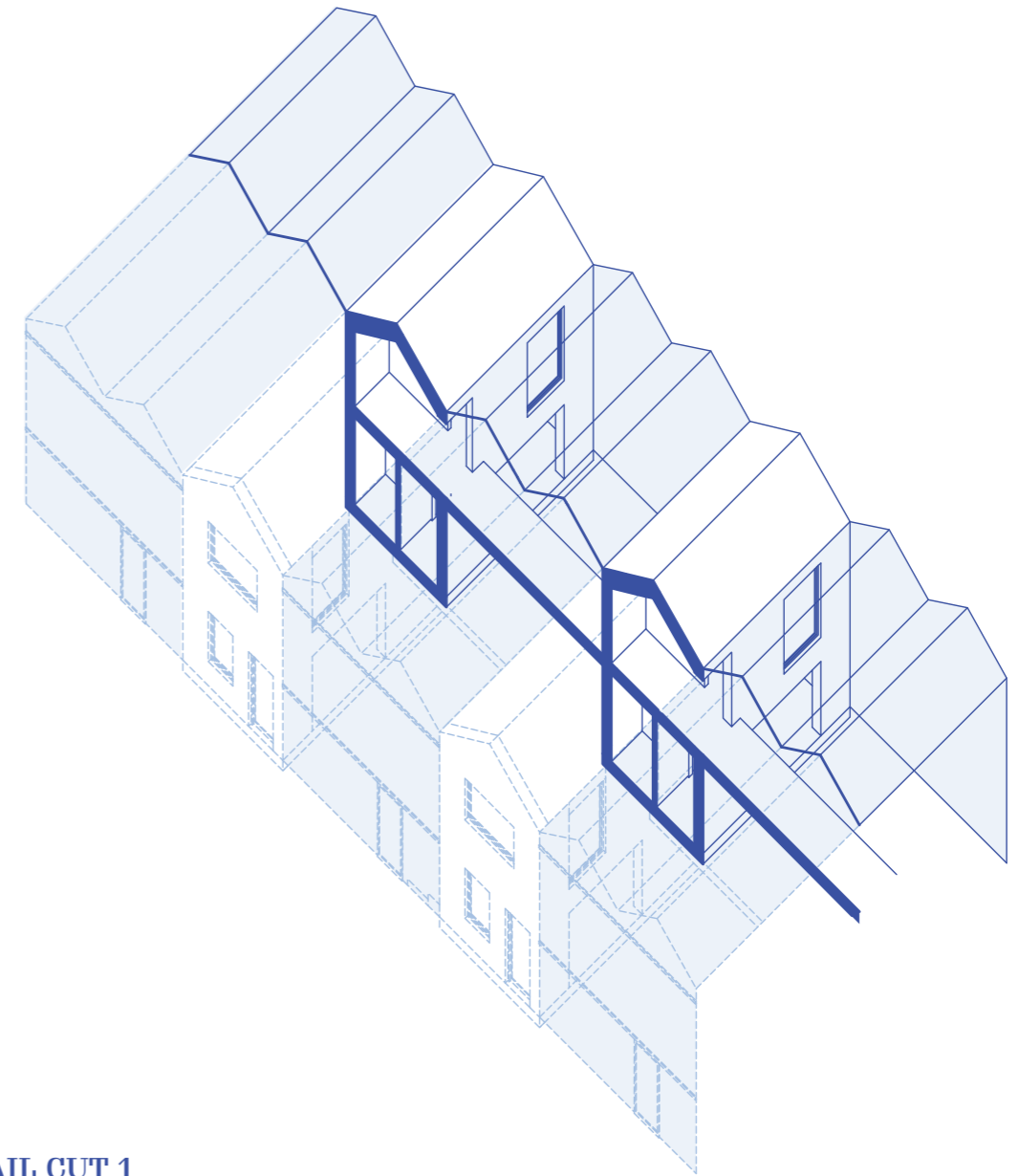

Figure 43. Facade elevation towards the greenhouse, showing the partition of wood and rammed earth sections



**DETAIL CUT 1**

*Through the rowhouse and the greenhouse.*

#### IV. Application

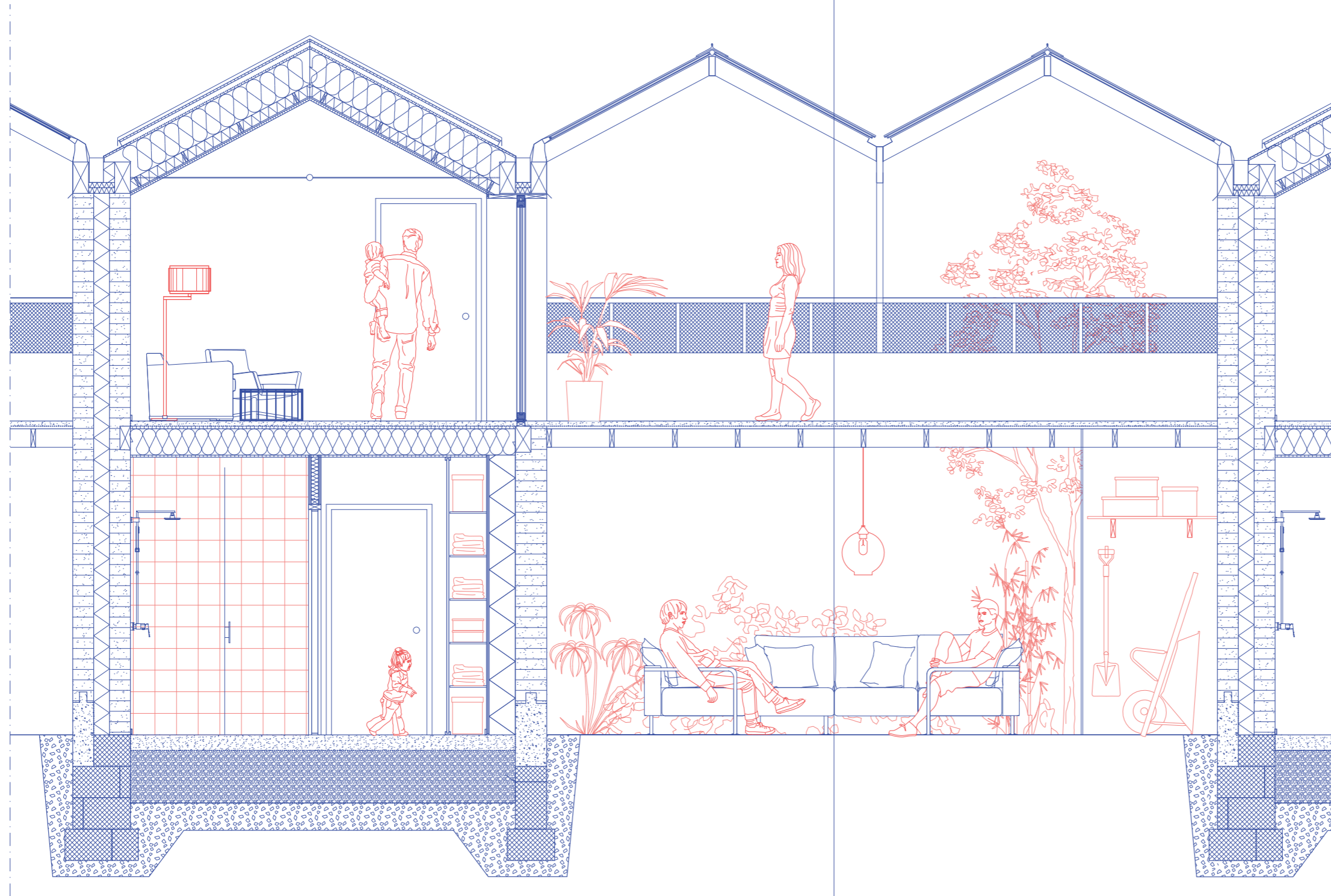

1:40 0 1000mm

#### Detail overview

On this page is an overview of the rowhouse in detail, these details are explained in the next pages.

The rowhouse consists of a heated part connected to a semi-outdoor greenhouse. The two floors are bound together with a bridge through the greenhouse, also working as a space for the upper living room to expand onto. The load of the bridge is carried by two massive wood beams of 900mm, which are also supporting the glass structure of the greenhouse.

As previously mentioned, different solutions are made for different types of walls. This redesign proposal can thereby, be viewed as a compilation of possible wall compositions using rammed earth in a Swedish context.

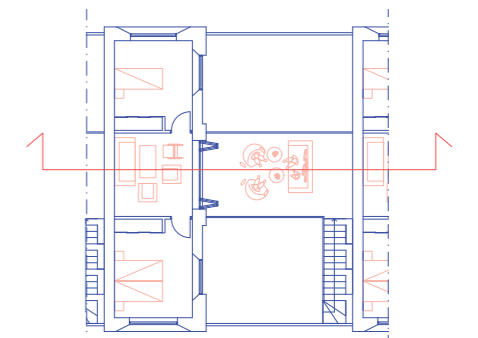

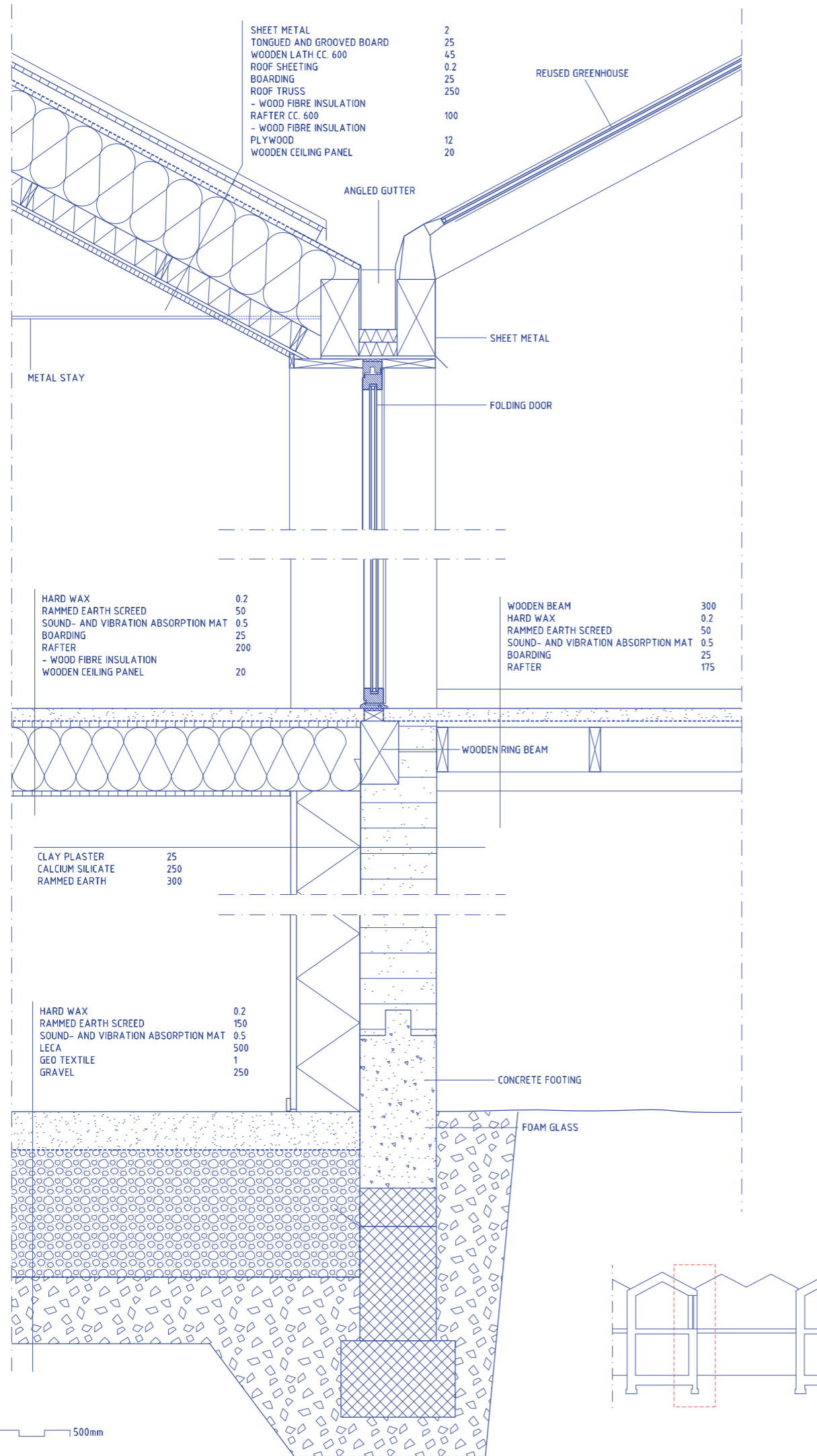

### Greenhouse wall

For aesthetical and technical reasons, the rammed earth is placed towards the greenhouse where it is less interrupted by interior walls and intermediate floors. Since the wall can be exposed to moisture from the ground in the greenhouse, a concrete footing is suggested to protect the earth. The wall is designed to aid the moisture permeability properties of the rammed earth walls, with no vapor barriers. To avoid problems with condensation caused by placing the insulation on the inside, calcium silicate is used as insulation material instead of wood fiber which is sensitive to moisture.

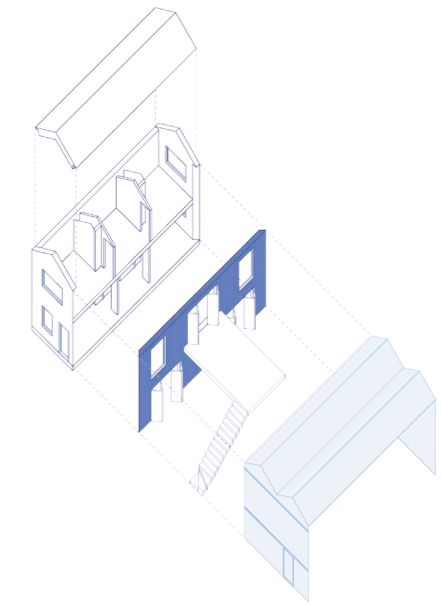

Rammed earth walls are supported by a foundation of foam glass with a layering of gravel and LECA (light weight clay aggregate) under the rammed earth screed. To make the earth floor more withstanding, a layer of hard wax is added as finishing.

### Rammed earth wall detail, plan

Details showing the meeting between the rammed earth wall and wooden sections above the openings in the greenhouse wall.

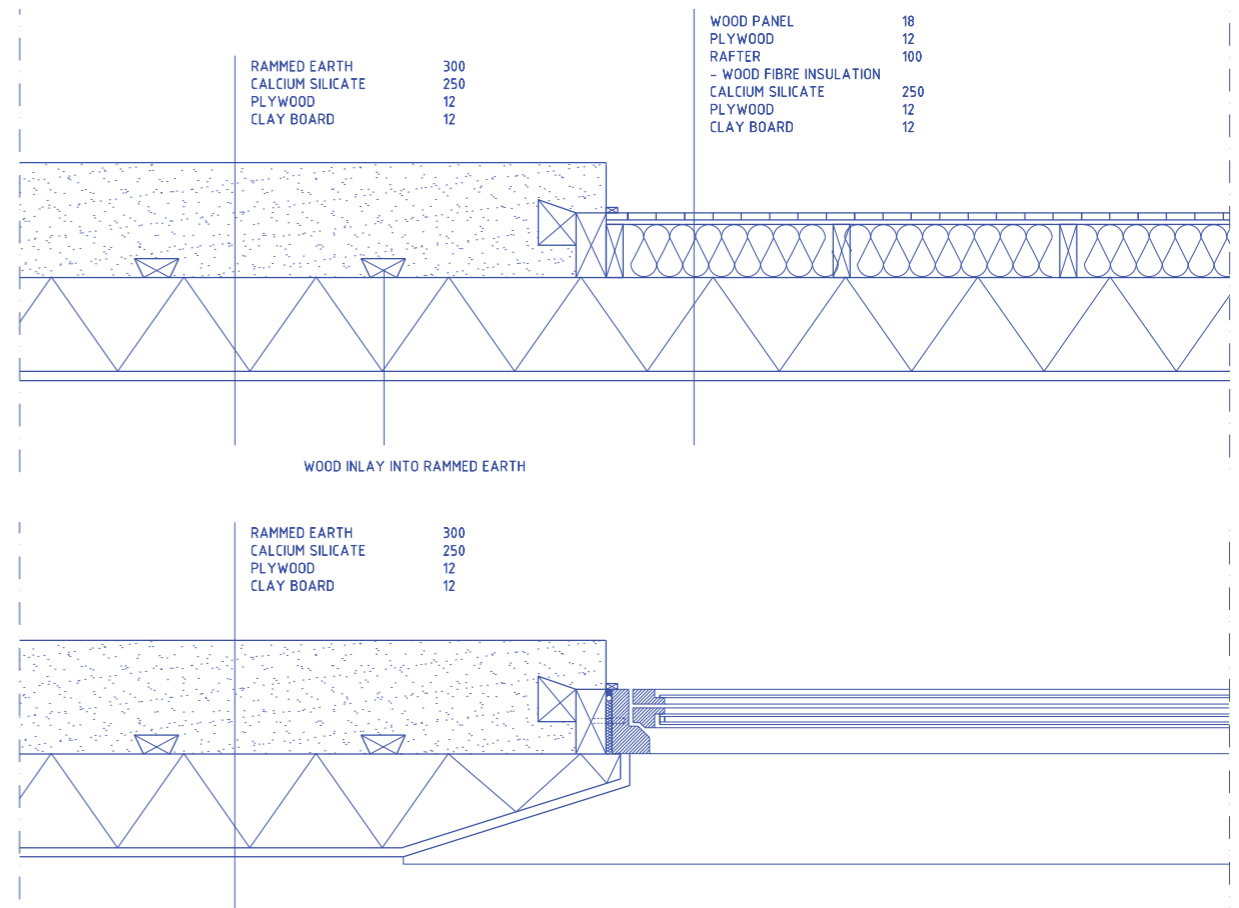
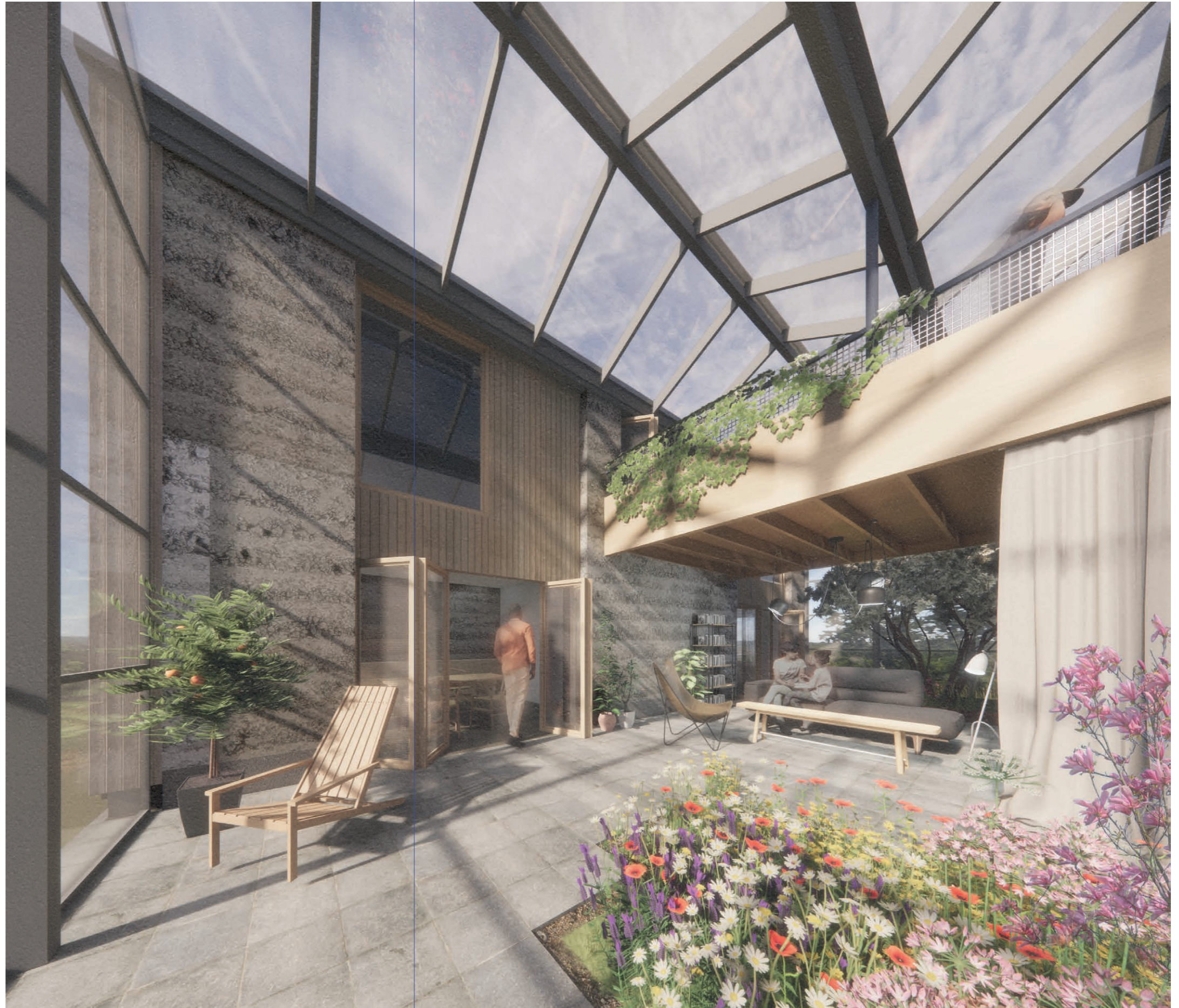
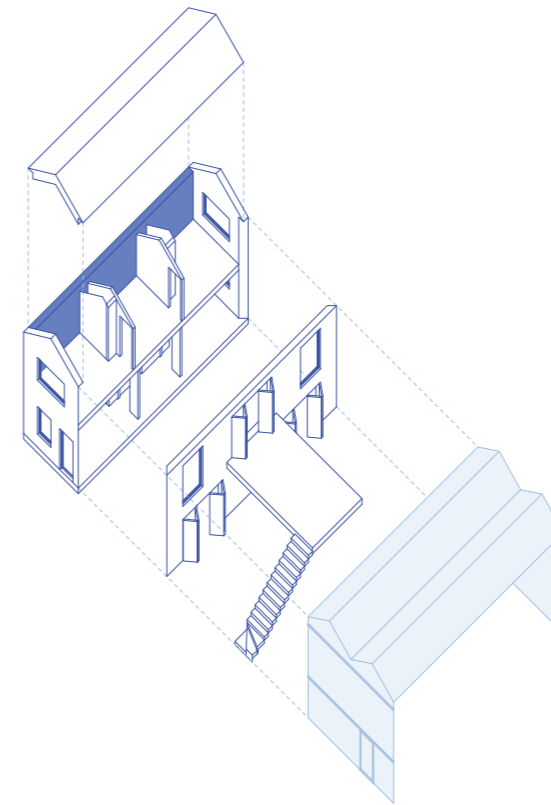
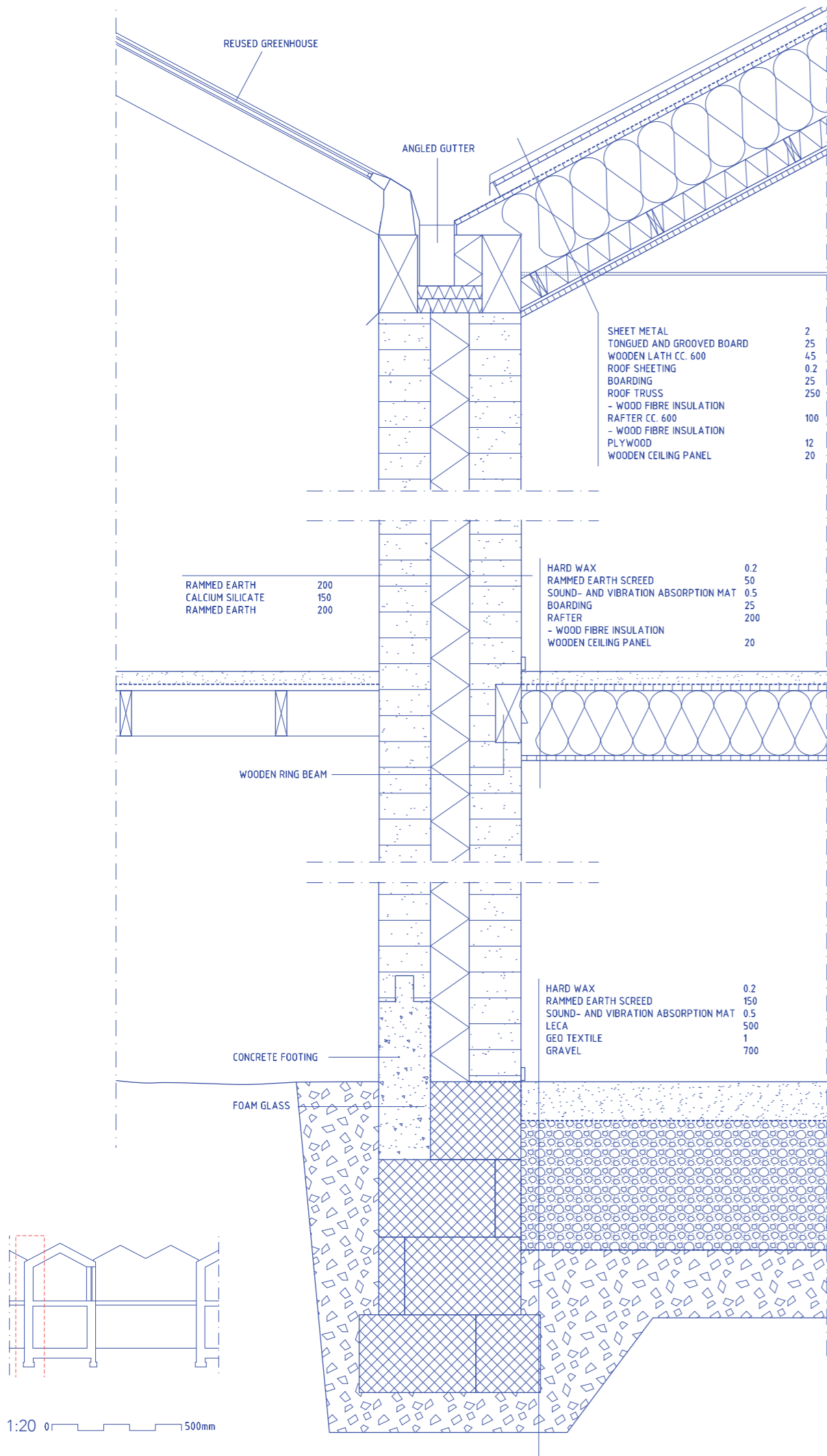

Figure 44. Perspective showing the facade towards the greenhouse.





### Separating wall

This wall is proposed as a cavity wall with a concrete footing towards the outside similar to the opposite wall. The bridge is supported by a loadbearing storage space underneath and not attached to the separating wall from the greenhouse. The structure is stabilized by wooden ring beams, one laying on top and one in the middle, rammed into the wall supporting the intermediate floor.

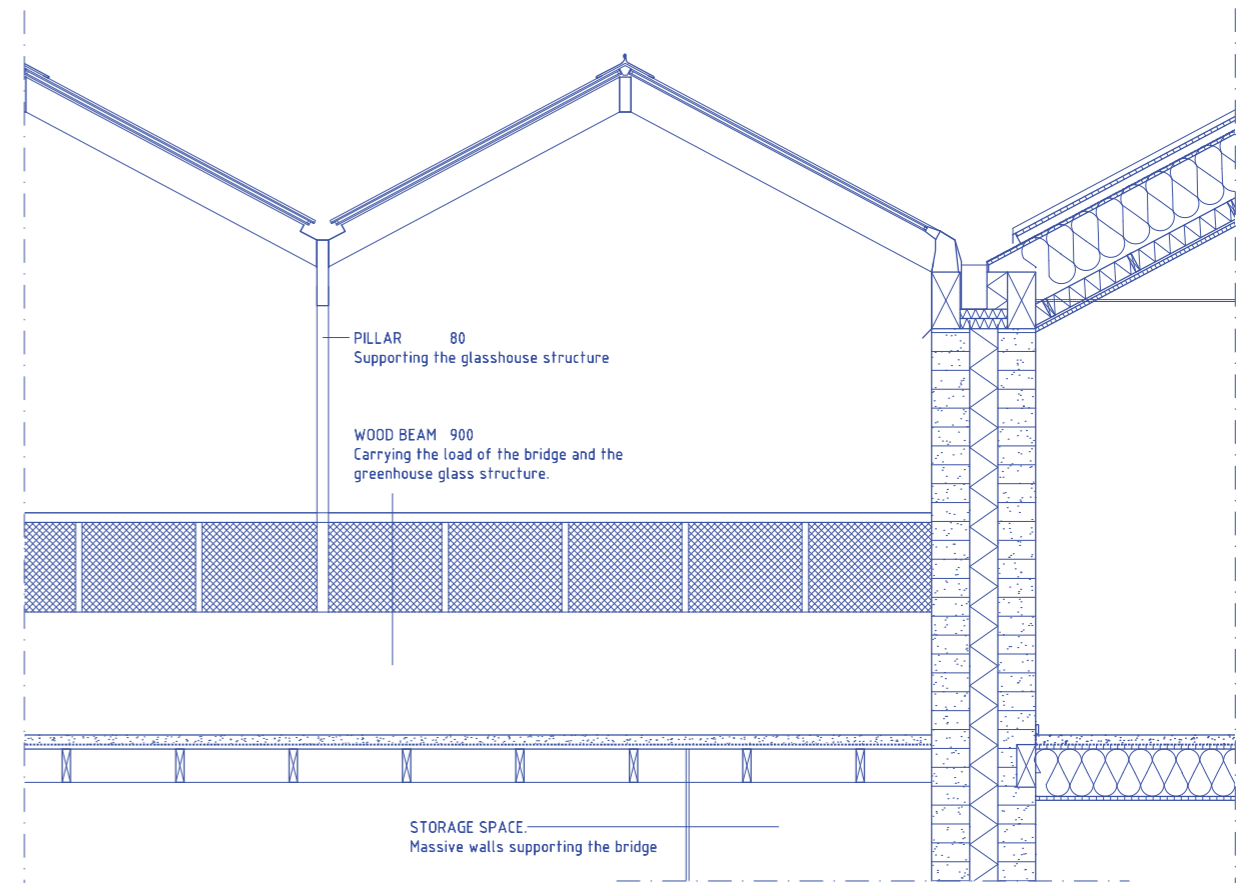

### Bridge construction

1:40 0 1000mm

Figure 45. Perspective showing the interior in the first floor.

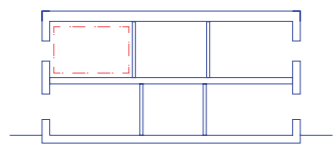

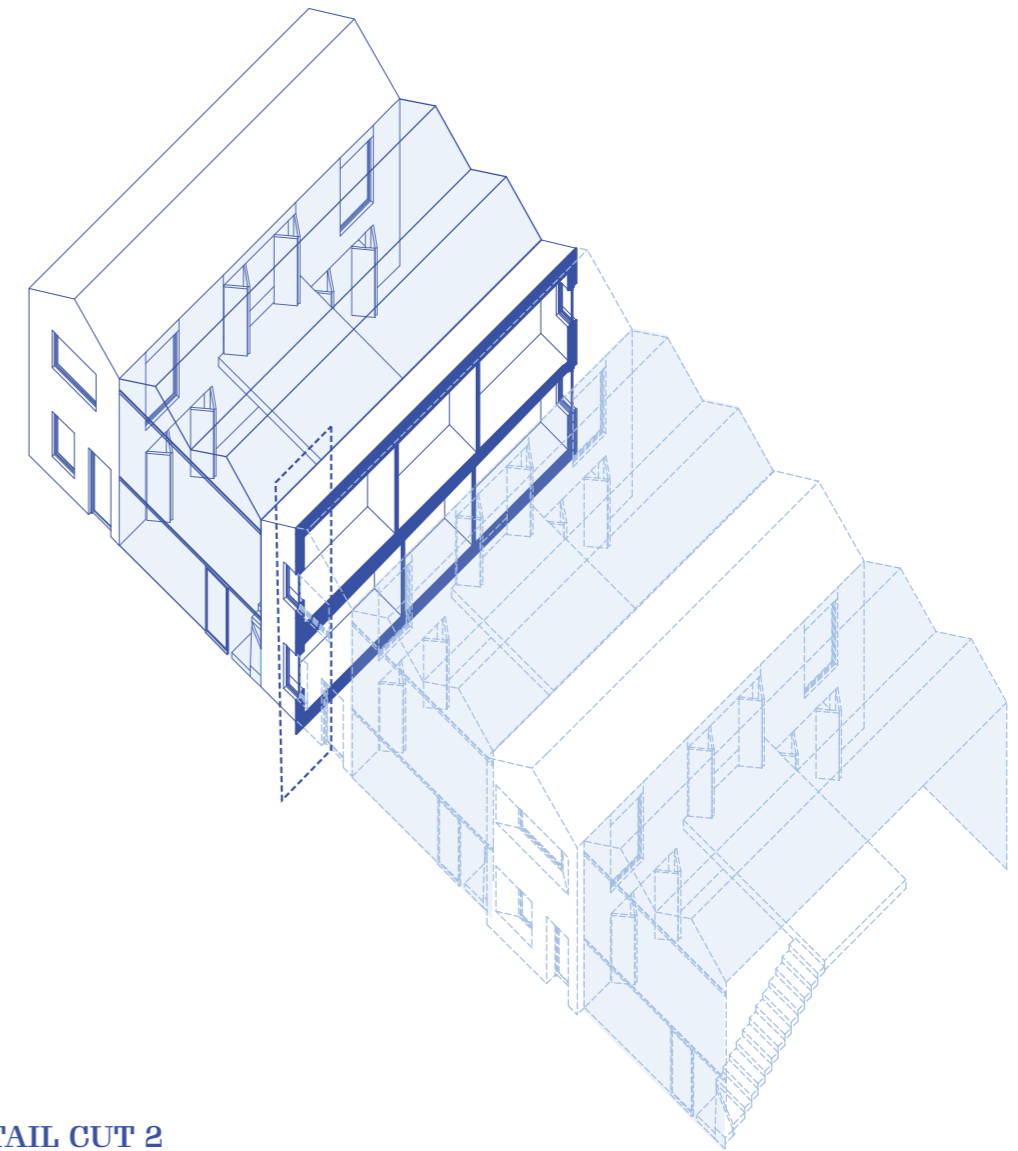

**DETAIL CUT 2**

*Through the exterior wall.*

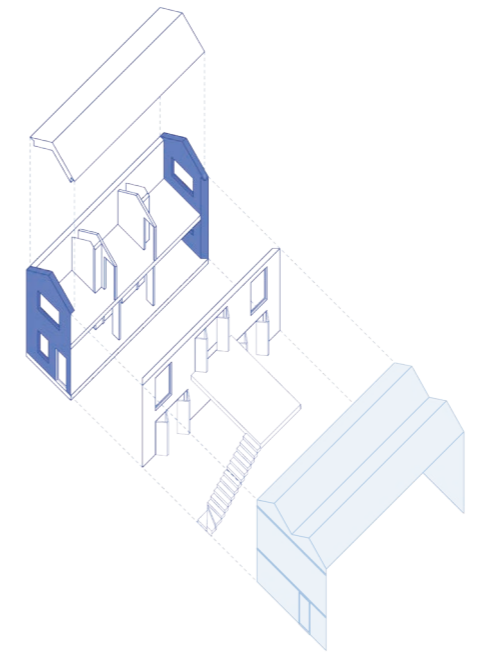
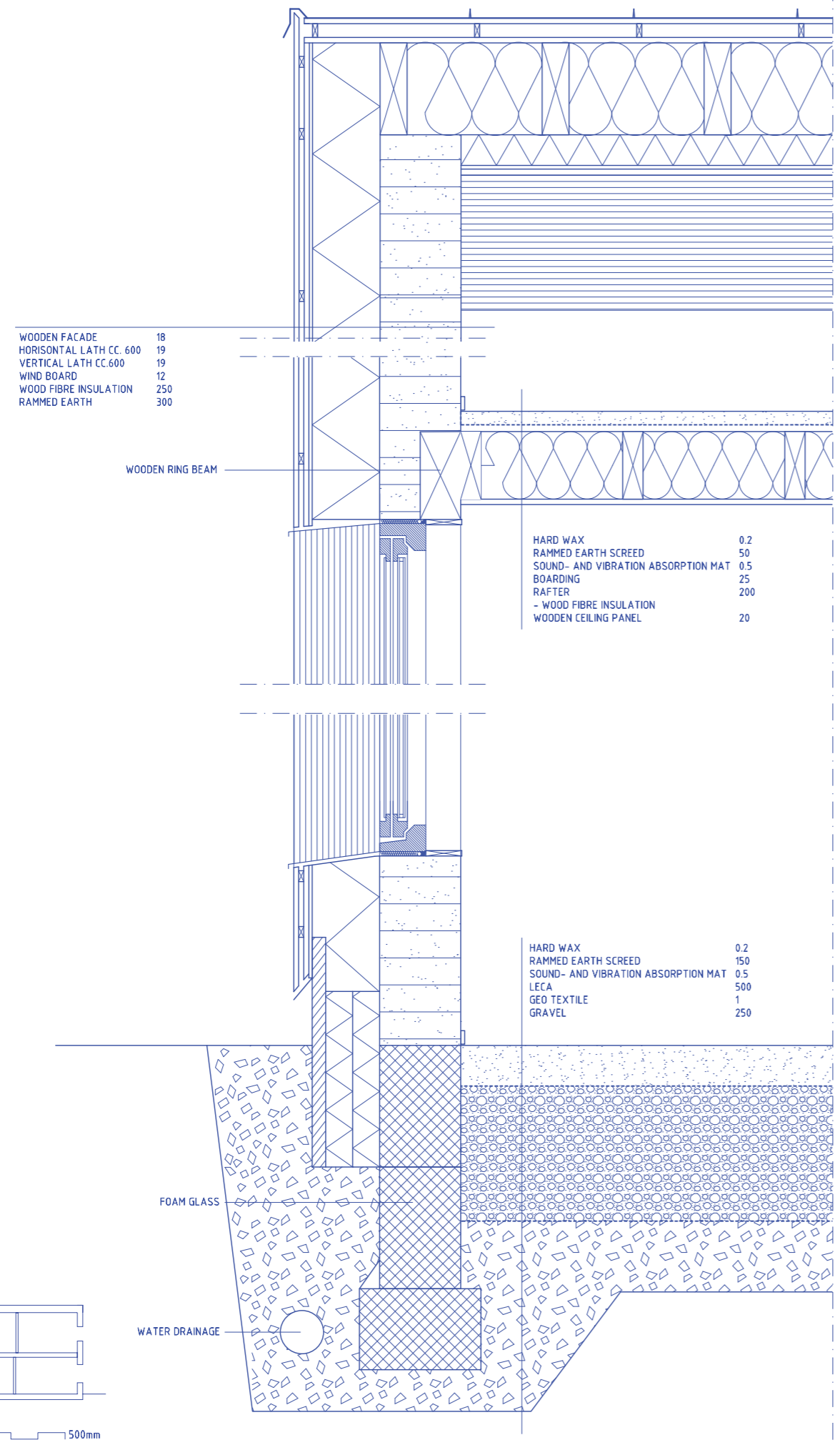

**Exterior wall**

The exterior walls are the most exposed walls. Even though it would be nice to show the earth in the exterior, it makes more sense to place it on the inside, with a greater positive impact on the indoor climate and avoiding constructional uncertainties caused by erosion.

The light situation as well as visual outlook through the window are limited by the wall thickness of about 60 cm, and can be improved by angled window reveals, see below.

In this solution the insulation is placed on the exterior side, minimizing the risk of condensation inside the wall. Therefore wood fiber insulation is proposed as insulation material here, which is cheaper and provides a better U-value.

**Window detail, plan**

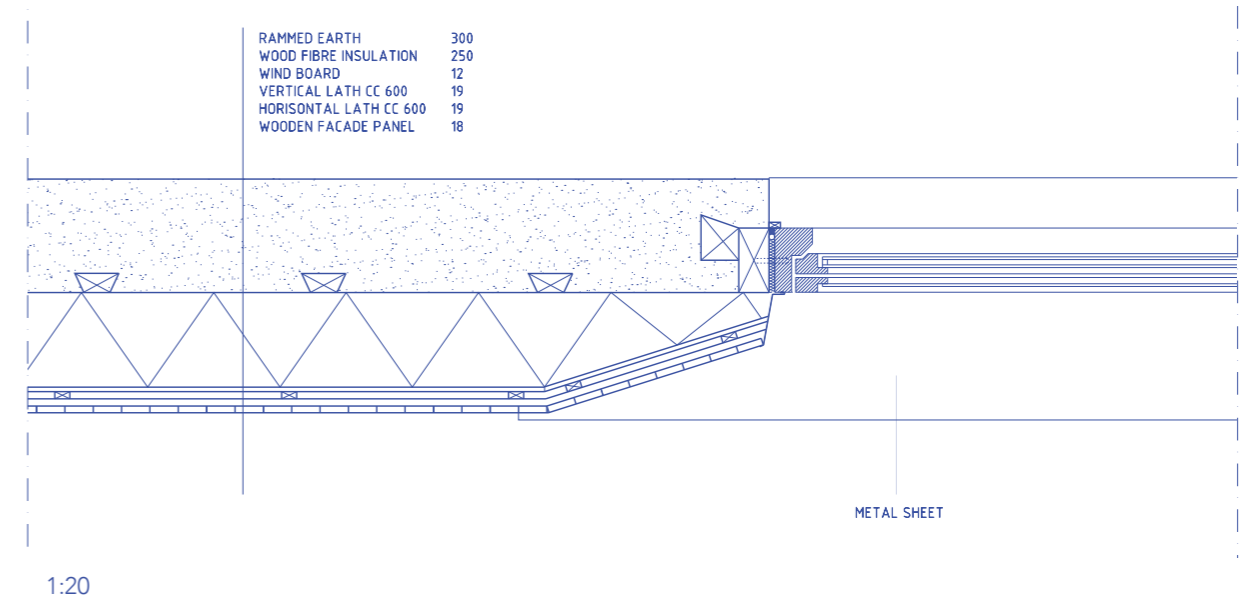

Figure 46. Perspective showing the entrance side of the rowhouse.



## V. Discussion

### DISCUSSION

#### **Q1. What are the obstacles in implementing rammed earth in a Swedish context?**

The main challenge in implementing rammed earth in a Swedish context lies in the lack of experience and local tradition. Building laws and regulations are formulated in a way that promotes industrial materials with extreme safety factors. These numbers make it hard to argue for materials like rammed earth with less safety factor even though the safety factor, in this case, is more than enough. Varying properties depending on the excavation site is another challenge making it hard to approve rammed earth as a building material in general, though it is possible to achieve approval based on careful monitoring and consistent testing during production. This requirement makes the implementation economically challenging in small-scale projects using in-situ excavated earth which must be tested. On the other hand, the potential of implementing rammed earth in a more industrial context, using excavated earth from construction sites like Västlänken, is better. In an industrial context, the testing system will become standardized and earth from the same source could be used in multiple projects reducing the testing cost.

Rammed earth is traditionally used in warmer and dryer climates, making the climate impact in Sweden unsure, with wind-driven rain causing erosion. Nevertheless, there are multiple examples of rammed earth structures standing the test of time in places with similar climates. Unlike more conventional materials, the appearance of exposed rammed earth will change due to erosion, which must be considered and aesthetically accepted.

Since it is not yet a conventional material, rammed earth can't economically compete with other more standardized wall compositions due to intense manpower demand and no established industry. Thereby making it available only to the few

economically privileged. Focus on this target group can be seen as a first step in creating a demand on the market, making investments and upscaling worthwhile for the producers.

#### **Q2. How can one through design overcome the limits of rammed earth in a Swedish context?**

Protection against erosion and prefabrication are considered necessary in making rammed earth feasible in a Swedish context. The problem of erosion can be solved in many ways which have been discussed in this thesis. Rammed earth possesses an aesthetically attractive surface indoors as well as a façade material. Additional insulation is needed in a Swedish context making it necessary to decide where to place the insulation in relation to the rammed earth wall. Placing the insulation on the outside would solve the problem of erosion, and provide a good indoor climate taking advantage of the earth properties.

As previously mentioned, prefabrication is necessary to make rammed earth fit the Swedish context today, unless future robotic in situ production is implemented. Prefabrication can be in the form of a small mobile factory enabling finer assembly without the need for overly time-consuming retouching or in a bigger industrial form, preferably as smaller elements to avoid damaged edges due to heavy lifting.

#### **Application reflection**

Viadal eco-village consists of 25 rowhouses combined with reused greenhouses. The context scale of the redesign object enables a proposal of in situ prefabrication, with the potential of weather-protected production using the already existing greenhouses. The combination of rammed earth and greenhouses are particularly interesting since the problem of erosion is solved and the moisture regulating properties of the earth wall can improve

the indoor climate of the greenhouse. Exposed earth inside the greenhouse provides thermal inertia and has the potential of extending the yearly comfort temperature hours.

Since vapor barriers should be avoided when working with earth, extra attention must be paid to the choice of insulation material depending on its placement. When placing the insulation on the inside of the rammed earth wall, there is a risk of condensation of the air inside the insulation, which the material must handle.

The proposed wall composition is very thick, about 60 cm in a two-story building to fulfill the structural and thermal needs. The thickness creates challenges with daylight and outlook, meanwhile, the thickness can be of emotional value. Thick massive walls create a feeling of being protected. The thickness tells the story of the material, it gives the structure an honesty which can make the experience of the space more pleasant. The challenges mentioned can easily be solved by angled window niches, and thickness itself can provide sun shading during the summer. Rammed earth can't take tensile loads, making big openings structurally more complicated than a wooden or concrete structure. In the redesign proposal, rammed earth above the largest openings is avoided to make the construction simpler and make it easier to visually read and understand the building.

#### **Future potential**

As discussed in the economy chapter, rammed earth has a huge future potential. It is a circular material with very low embodied energy, making it particularly interesting in a world without fossil fuels. There are ongoing research projects on optimizing the ramming process by reducing the production speed. Future implementation of carbon taxes is predicted, enforcing a more circular economy which would

strengthen rammed earth from an economic point of view. In a future circular economy, the system of approving secondary material must be updated, with authorized quality assurances and warranties, which would further ease the implementation of earth as a building material.

The experience and knowledge are there, though on a limited scale spread out worldwide. Knowledge is being shared, and the facts are there, but the first steps towards implementing rammed earth in a Swedish context are still challenging to overcome. Initial investments are large, and the refund is unsure, especially since there is not yet a public demand for rammed earth, due to a limited experience of the material. By implementing rammed earth in public projects with large budgets, the experience and knowledge of the material can be spread, aiming to improve the perception and further on increasing the demand. Ways of improving the general perception of earth as a building material did not fit the scope of this master's thesis but would be very interesting to explore further.

Kick-start funding on a governmental level, as part of a climate transformation investment, could also give rammed earth a chance to get into the market. Preferably in combination with knowledge exchanges with other already established companies abroad. The potential of lending/renting industrial equipment might also ease the process and decrease the initial investments needed.

#### **Personal impressions**

The perks of rammed earth are many, both environmentally but also for personal health. In a society with increasing awareness on health disturbing chemicals, rammed earth should be of interest to many people. That it's not could be explained by building materials, and their health impact, being much less mentioned in media and therefore not known among the public. Buildings in Sweden tend to have a very dry indoor climate

## ***V. Discussion***

during the winter. Summer time, heat is trapped inside because of thermal insulation dimensioned to endure the winter. Rammed earth would solve both these issues by its moisture regulating properties and thermal inertia. If this was communicated together with the material advantages of not risking health at any phase of its production, then there could be an increased demand for rammed earth on the market. However, human beings tend to fear changes, especially if it means materials without guarantees and legal support. One of the outcomes of this thesis though, is that legal approval shouldn't be a problem if some precautions, like erosion protection and frequent quality testing during production, are taken.

Another observation during this thesis is that concrete will always perform better. Rammed earth will always have lower compressive strength and safety factor even though it is more than enough. It seems hard to argue for a new material, when the old one always performs better structurally, even if the environmental benefit of the new material is outstanding. As long as society is adapted to a linear economy, rammed earth won't be able to compete with more conventional materials like concrete, which is cheaper, stronger, and lasts longer. Material producers will always campaign for their own products and the environmental footprint of most materials is slowly decreasing, which is enhanced and communicated to the customer. Agreeably most materials are getting better but when comparing them to sustainable materials like rammed earth, it becomes hard to compete, which is less emphasized by the conventional material producers.

As people continue pushing for an environmental transformation, rammed earth stands a chance. With no decreased value on the secondary market, rammed earth has a real potential of competing when society becomes circular. Concrete is much harder to dispose of compared to earth which can simply be returned to the ground. If the responsibility of the "end of life" stage of a material is given to the producer, the economic competitiveness of rammed earth would be even more improved.

## ***Conclusion***

Rammed earth has a great potential in reducing emissions caused by the building sector. All challenges in implementing rammed earth in a Swedish context are solvable, but the first steps and investments needed are huge in proportion to the lack of demand on the market. The much-needed transition into a more sustainable society is approaching, and with it comes a demand for more sustainable building solutions, where rammed earth is prominent.

## LIST OF REFERENCES

Arbetsmiljöverket. (2012). Belastningsergonomi, AFS 2012:2. <https://www.av.se/arbetsmiljoarbete-och-inspektioner/publikationer/foreskrifter/belastningsergonomi-afs-20122-foreskrifter/>

Boverket. (2019). Boverkets konstruktionsregler EKS 11. [www.boverket.se/publikationer](http://www.boverket.se/publikationer)

Boverket. (2022). Krav på byggnadsverk. <https://www.boverket.se/sv/PBL-kunskapsbanken/regler-om-byggande/krav-pa-byggnadsverk-tomter-mm/byggnadsverk/>

Boverket. (2022a). Introduktion till byggreglerna i PBL, PBF och BBR. <https://www.boverket.se/sv/PBL-kunskapsbanken/pbl-akademien/pbl-webbutbildningar/introduktion-pbl-pbf-och-bbr/>

Boverket. (2022b). Krav på byggnadsverk. <https://www.boverket.se/sv/PBL-kunskapsbanken/regler-om-byggande/krav-pa-byggnadsverk-tomter-mm/byggnadsverk/>

Boverket. (2022c). När BBR ska tillämpas. <https://www.boverket.se/sv/PBL-kunskapsbanken/regler-om-byggande/boverkets-byggregler/om-bbr/nar-bbr-ska-tillampas/>

Boverket. (n.d.). Konsoliderad version av Boverkets byggregler (2011:6) – föreskrifter och allmänna råd.

Bui, Q. B., Morel, J. C., Venkatarama Reddy, B. v., & Ghayad, W. (2009). Durability of rammed earth walls exposed for 20 years to natural weathering. *Building and Environment*, 44(5), 912–919. <https://doi.org/10.1016/j.buildenv.2008.07.001>

Burström, P. G. (2021). Byggnadsmaterial Tillverkning, egenskaper och användning. Studentlitteratur AB.

Construction and demolition waste: challenges and opportunities in a circular economy. (2020, January 16).

European Environment Agency. <https://www.eea.europa.eu/publications/construction-and-demolition-waste-challenges/construction-and-demolition-waste-challenges>

Dethier, J. (2020). *The art of earth architecture* (English version). Thames & Hudson Ltd.

Dobson, S. (2000). TERRA 2000, Continuity of tradition: New earth building. Key Note Speech. <https://rammedearth.davis.net.au/Terra2000.php>

European Standards. (2022). Eurocodes. <https://www.en-standard.eu/eurocodes/>

Granmar, M. (2021). *Naturhus, Bygg, bo och odla för en hållbar framtid*. Natur & Kultur.

Grunacker, M. (2021). *Clay-ver - To build with what is under our feet* [Master's thesis]. Chalmers University of Technology.

Hanania, J., Stenhouse, K., & Donev, J. (2015). Trombe wall. *Energy Education*. [https://energyeducation.ca/encyclopedia/Trombe\\_wall](https://energyeducation.ca/encyclopedia/Trombe_wall)

Heringer, A., Howe, L. B., & Rauch, M. (2020). *Upscaling earth: Material, Process, Catalyst*. ETH Zürich & gta Verlag.

Keable, J., & Keable, R. (1996). *Rammed earth structures, a code of practice* (Second edition). Practical Action Publishing Ltd.

LEEDuser. (2022). LEED V4. <https://leeduser.buildinggreen.com/content/note-caution-regional-materials-leed-v4>

Lehm Ton Erde Baukunst GmbH. (n.d.). *Design Guide for Rammed Earth Building with 100 % earth*.

Luo, Y., Yang, M., Ni, P., Peng, X., & Yuan, X. (2020). Degradation of rammed earth under wind-driven rain: The case of Fujian Tulou, China. *Construction and Building Materials*, 261. <https://www.sciencedirect.com/science/article/pii/S0950061820319942>

Lyon, the confluence (Rhône) Pisa carrier. (2019). *Le Pisé*. <http://www.construction-pise.fr/Lyon-la-confluence-Rhone-393>

Matsdotter, V. (2020). *Down to earth* [Master's thesis]. Chalmers University of Technology.

Micke. (2018, August 23). Obehaglig extrakostnad man inte budgeterat med. <https://www.husgrunder.com/markarbete/deponeringsavgift/>

Minke, G. (2006). *Building with Earth, Design and Technology of a Sustainable Architecture*. Birkhäuser-Publishers for Architecture.

Osterling, T. (2022). *Regn*. *Teknikhandboken*. <https://www.teknikhandboken.se/handboken/paverkan-pa-tak-och-fasader/yttre-paverkan/regn/>

Pettersson, B., & Olsson, C. (2019). *Underlag för projektering av ytterväggar* [Bachelor's thesis]. KTH Skolan för arkitektur och samhällsbyggnad.

Rauch, M. (2015). *refined earth construction & design with rammed earth* (O. Kapfinger & M. Sauer, Eds.). DETAIL.

Robotic fabrication of components from rammed earth. (2019, August 7). DBZ. [https://www.dbz.de/artikel/dbz\\_Robotische\\_Fabrikation\\_von\\_Bauteilen\\_aus\\_Stampflehm\\_3390495.html](https://www.dbz.de/artikel/dbz_Robotische_Fabrikation_von_Bauteilen_aus_Stampflehm_3390495.html)

Sundbergs Åkeri AB. (2022). *Kranbil*. <https://www.sundbergs.se/services/kranbil/>

Sweden's carbon tax. (2022). Government Offices of Sweden. <https://www.government.se/government-policy/swedens-carbon-tax/swedens-carbon-tax/>

Swedish Standards Institute. (2019). EN 13501-1:2019. [www.sis.se](http://www.sis.se)

Tekniska egenskaper. (n.d.). *Betongindustri*. Retrieved April 28, 2022, from <https://www.betongindustri.se/sv/tekniska-egenskaper>

The construction material pyramid. (n.d.). Cinark/The Royal Danish Academy and Vandkysten Architects. Retrieved April 28, 2022, from <https://www.materialepyramiden.dk>

Trafikverket. (2021, February 16). *Transport av breda hus och husmoduler*. <https://bransch.trafikverket.se/for-dig-i-branschen/vag/Transportdispens/transport-av-breda-hus-och-husmoduler/>

Verdicchio, M. (2018, April 6). Hit ska leran från västlänken köras. *Göteborgsposten*, 6–7.

### ***Image references***

Bui et al. (2009). Unstabilised reference wall no. 29 made with MRE (unstabilised rammed earth), facing West. and General view from the south of the walls on the site. [Photograph] Reprinted from Building and Environment, 44 /5, Q.B. Buiab, J.C. Morel, B.V. Venkatarama Reddy, W. Ghayadab, Durability of rammed earth walls exposed for 20 years to natural weathering, 912-919, Copyright (2009), with permission from Elsevier.

Bühler, B. (n.d.) [Photograph]. Lehm ton Erde. <https://www.lehmtonerde.at/en/projects/project.php?pid=7>

Escobar, D. (2013). Rath House. [Photograph]. Earthlab. <https://earthlabstudio.com/2013/11/24/rath-house-and-earth-skyscrapers/>

Fetdeterra. (2022). PRODUCTS - WALLS LARGE SIZE. [Photograph]. FETDETERRA. <https://www.fetdeterra.com/en/producto/tapialblock-lc/>

Foulliet, F. (2021). „L'Orangérie“ in Lyon. [Photograph]. DETAIL. [https://www.detail.de/de/de\\_de/traditionspflege-in-286-teilen-lehmbau-lorangerie-in-lyon](https://www.detail.de/de/de_de/traditionspflege-in-286-teilen-lehmbau-lorangerie-in-lyon)

Heckhausen, P. Hilgert, F. (2017) MOCK-UP SITTEWERK, ST. GALLEN, 2017. [Photograph]. LEHMAG AG. <https://lehmag.ch/projekt/mock-up-sitterwerk-st-gallen/>

Henman, D. (2004). Rammed earth walls surrounding Horyuji Temple, Japan. [Photograph] Reprinted from Construction and Building Materials, 18 /4, Hall, M. Djerbib, Y, Rammed earth sample production: context, recommendations and consistency, 281-286., Copyright (2004), with permission from Elsevier

Robert. (2013-2014). Ricola Kräuterzentrum: Lehmfassade mit Holztür. [Photograph]. Made by Architects. <https://www.made-by-architects.com/user/u6-robert/buildings/915-Ricola-Kraeuterzentrum-in-Schweiz-Laufen-von-Herzog-de-Meuron>

Windgårdh Architects. (2022). Redesign object. [Illustrations]. Communicated through Vera Matsdotter.

## **APPENDIX**

## Appendix

### 1. MECHANICAL RESISTANCE AND STABILITY

Bärförmåga, stadga och beständighet

#### PBL (2010:900) 8 kap 4§:

1. Mechanical resistance and stability. (bärförmåga, stadga och beständighet)

#### PBF (2011:338) 3 kap 14§:

För att uppfylla det krav på bärförmåga, stadga och beständighet som anges i 8 kap.

4 § första stycket 1 plan- och bygglagen (2010:900) ska ett byggnadsverk vara projekterat och utfört på ett sådant sätt att den påverkan som byggnadsverket sannolikt utsätts för när det byggs eller används inte leder till

1. att byggnadsverket helt eller delvis rasar,
2. oacceptabla större deformationer,
3. skada på andra delar av byggnadsverket, dess installationer eller fasta utrustning till följd av större deformationer i den bärande konstruktionen, eller
4. skada som inte står i proportion till den händelse som orsakat skadan.

The requirements of mechanical resistance and stability of construction work during construction and usage are based on the following criteria not happening.

1. That the construction work collapse, fully or partly.
2. Unacceptable deformations.
3. Damage of parts of the construction work, its installations, or other fixed types of equipment caused by deformations in the load-bearing construction.
4. Damage, not in proportion to the incident.

#### EKS – Section A

##### Load bearing capacity

6 § Byggnadsverk och byggnadsverksdelar ska med tillräcklig tillförlitlighet ha en bärförmåga som är lika med eller större än lasteffekten under byggnadsverkets användningstid samt under uppförandet. Byggnadsverket ska också ha statisk jämvikt så att det stabiliserande momentet är lika med eller större än det stjälpande. (BFS 2015:6).

Construction works and their partitions must possess a loadbearing capacity equal to or greater than the impact of loads during their usage and construction. Construction works must additionally be statically stable.

##### Stability

15 § Byggnadsverk och byggnadsverksdelar ska ha tillräcklig stadga. (BFS 2015:6).

Construction works and their partitions must hold sufficient stability. Construction works and partitions are stable when swaying, vibrations, cracking and similar events only occur in an acceptable magnitude.

##### Durability

16 § Byggnadsverksdelar och material som ingår i bärande konstruktioner ska antingen vara naturligt beständiga eller göras beständiga genom skyddsåtgärder och underhåll så att kraven i brottgräns- och bruksgränstillstånd uppfylls under byggnadsverkets livslängd. Är permanent skydd inte möjligt ska förväntade förändringar av egenskaperna beaktas vid dimensioneringen. Konstruktionen ska vid förutsatt underhållsbehov utformas så att de påverkade delarna blir åtkomliga för återkommande skyddsåtgärder och underhåll. (BFS 2015:6).

Construction works partitions and materials in a load-bearing structure must be durable, naturally or by interventions and maintenance ensuring

durability during its lifetime. If permanent durability is not achievable, this must be considered when dimensioning the structure. When maintenance is expected, the structure must be designed to allow protective measurements and reparations.

##### Materials

17 § Material till bärande konstruktioner, inklusive jord och berg, ska ha kända, lämpliga och dokumenterade egenskaper i de avseenden som har betydelse för deras användning. (BFS 2015:6).

Materials used in load-bearing structures must hold known, appropriate, and documented properties relevant for its use.

##### Evaluating methods

18 § Med byggprodukter med bedömda egenskaper avses i denna författning produkter som tillverkats för att permanent ingå i byggnadsverk och som antingen

- a) är CE-märkta,
- b) är typgodkända och/eller tillverkningskontrollerade enligt bestämmelserna i 8 kap. 22–23 §§ PBL,
- c) har certifierats av ett certifieringsorgan som ackrediterats för uppgiften och för produkten i fråga enligt förordning (EG) nr 765/2008 av den 9 juli 2008 om krav för ackreditering och marknadskontroll i samband med saluföring av produkter och upphävande av förordning (EEG) nr 339/934, eller
- d) har tillverkats i en fabrik vars tillverkning och produktionskontroll och utfallet därav för byggprodukten fortlöpande övervakas, bedöms och godkänns av ett certifieringsorgan som ackrediterats för uppgiften och för produkten ifråga enligt förordning (EG) nr 765/2008.

Construction products with evaluated properties are products produced to permanently constitute construction works. They must either be:

1. CE-marked,
2. type-approved according to 8 chap. 22-23§ PBL,
3. approved by a certification body or
4. be produced in a factory, continuously monitored, controlled, and approved by a certification body.

(Boverket, 2019)

#### Theoretical findings

##### Load-bearing capacity

Earth used for building often has a compressive strength of 20-50kg/cm<sup>2</sup>. According to German standards, the required compressive strength of walls is 3-5kg/cm<sup>2</sup> from buildings with a maximum of two stories. Increasing the compressive strength of rammed earth is therefore seldom needed. The compressive performance differs widely depending on clay type and content as well as the proportion of silt, sand, and gravel. (Minke, 2006) The great variety in performance requires new tests for every new location of excavation.

There are ways to improve the load-bearing capacity. One way is by adding dispersants to separate particles and achieving more compact elements by enabling the possibility to pour the mixture into the formwork, like concrete. Another way is by adding additives like cement. Neither of these methods will preserve the ecological benefits and the environmental impact will be even worse than ultra-high-performance concrete when using cement to achieve the same performance. (Dethier, 2020)

##### Stability

Unless the earth is rammed in situ as one homogenous element, the structure must be carefully constructed to achieve stability. Elements should be placed in a masonry bond to distribute the load and tied together with a ring beam or similar, to achieve the desired effect. (Lehm Ton Erde, n.d.)

## Appendix

### Durability

According to Van Damme & Houben, earth does struggle to achieve approved tests regarding mechanical performance and durability, especially in resistance to erosion for example. (Dethier, 2020) Erosion is inevitable when exposed to rain, though only to a certain depth when the swelling of the earth inhibits it. Matsdotter stresses the combination of heavy rain and wind as a threat to earthen constructions in a Nordic context, especially in Gothenburg where the rainwater contains salt. (2020) There are multiple ways to control erosion, either by so-called erosion checks (Rauch, 2015), projecting roofs, additional facades, and different types of cladding.

Aside from erosion, the rammed earth must be designed to withstand standing water, both on top and at the foundation.

### Conclusion

There are multiple examples worldwide of multi-story buildings in exposed non-stabilized rammed earth standing the test of time. Though it is necessary to stress the importance of the mixture and clay content. Different mixtures perform differently and are therefore hard to classify according to the regulations present today. Desired load-bearing capacity and stability shouldn't be a problem to achieve if the content is carefully controlled. Maybe it could be approved with the system described in point d under evaluation methods, monitoring and carefully checking the product in the context of a factory. Prefabrication could be the way to make rammed earth fit the Swedish regulation system.

The main difference from worldwide examples of rammed earth is the Swedish context. Buildings in Sweden are heavily exposed to the combination of rain and wind which has the risk of speeding up the erosion process. Different ways of ensuring the durability against weather in a Swedish context could be interesting to investigate further.

## 2. FIRE SAFETY

Säkerhet vid användning.

### PBL (2010:900) 8 kap 4§:

2. Fire safety (säkerhet i händelse av brand)

### PBF (2011:338) 3 kap 8§:

*För att uppfylla det krav på säkerhet i händelse av brand som anges i 8 kap. 4 § första stycket 2 plan- och bygglagen (2010:900) ska ett byggnadsverk vara projekterat och utfört på ett sätt som innebär att*

- 1. byggnadsverkets bärförmåga vid brand kan antas bestå under en bestämd tid,*
- 2. utveckling och spridning av brand och rök inom byggnadsverket begränsas,*
- 3. spridning av brand till närliggande byggnadsverk begränsas,*
- 4. personer som befinner sig i byggnadsverket vid brand kan lämna det eller räddas på annat sätt, och*
- 5. hänsyn har tagits till räddningsmanskaps säkerhet vid brand.*

To fulfill the requirement of fire safety described in PBL, the construction works must be designed to assure that:

- 1. The construction works, in the case of fire, can endure a certain amount of time.**
2. The development and spread of fire are limited.
3. The spread of fire to nearby structures is limited.
4. People residing in the construction works can leave or be rescued in one way or another.
5. The safety of the rescue party has been considered.
6. (Boverket, 2022b)

The requirement marked in bold is the one relevant when considering building material.

### EKS

The fire resistance of material should be documented according to a chapter in EKS, the Swedish standardization of the Eurocodes.

EN 13501 is a European standard given the status of a national standard.

*EN 13501, Fire classification of construction products and building elements consists of the following parts:*

- *Part 1: Classification using data from reaction to fire tests*
- *Part 2: Classification using data from fire resistance tests, excluding ventilation services*
- *Part 3: Classification using data from fire resistance tests on products and elements used in building service installations: fire resisting ducts and fire dampers*
- *Part 4: Classification using data from fire resistance tests on components of smoke control — systems*
- *Part 5: Classification using data from external fire exposure to roofs tests*
- *Part 6: Classification using data from reaction to fire tests on power, control and communication cables.*

(Swedish Standards Institute, 2019,)

### Theoretical findings

According to Lehm Ton Erde, rammed earth constructions pass all required fire resistance regulations. In tests, their rammed earth design achieves the European classification EN 13501 for fire resistance. (Lehm Ton Erde, n.d.)

This is backed up by the traditional use of loam in intermediate floors in old German timber frame houses, to increase the fire resistance. According to German standards, loam is non-combustible if the density is at least 1700 kg/m<sup>3</sup>. (Minke, 2006)

### Conclusion

There are examples of rammed earth passing classification tests for European standards. Though the performance of the material has a wide range in variations due to different mixtures. The way current laws and legislation are formed makes it hard to standardize a material with varying properties. Testing the fire resistance of a building material is very expensive (S, Hagy, Personal communication, 2022) and economically unaffordable to perform in each project with a new excavation site. The process of approving the material might be more feasible in the context of using excavated earth from construction sites of new infrastructure. If a factory is using the same earth for multiple projects, tests are applicable for bigger quantities. Here prefabrication is an interesting approach.

There is reason to believe that approved fire resistance is achievable for rammed earth with the knowledge of today. Further investigation on this topic is outside of the scope of this master thesis.

## 3. PROTECTION WITH REGARD TO HYGIENE, HEALTH AND THE ENVIRONMENT

*Skydd med hänsyn till hygien, hälsa och miljön.*

### **PBL (2010:900) 8 kap 4§:**

3. Protection with regard to hygiene, health and the environment (skydd med hänsyn till hygien, hälsa och miljön)

### **PBF (2011:338) 3 kap 9§:**

*För att uppfylla det krav på skydd med hänsyn till hygien, hälsa och miljö som anges i 8 kap. 4 § första stycket 3 plan- och bygglagen (2010:900) ska ett byggnadsverk vara projekterat och utfört på ett sådant sätt att det inte medför en oacceptabel risk för användarnas eller grannarnas hygien eller hälsa, särskilt inte som följd av*

- 1. utsläpp av giftig gas,*
- 2. förekomst av farliga partiklar eller gaser i luften,*
- 3. farlig strålning,*
- 4. förorening eller förgiftning av vatten eller mark,*
- 5. bristfällig hantering av avloppsvatten, rök eller fast eller flytande avfall, eller*
- 6. förekomst av fukt i delar av byggnadsverket eller på ytor inom byggnadsverket.*

To fulfill the requirements regarding hygiene, health, and the environment and ensure to avoid risking the health of users and neighbors, caused by any of the following:

1. Emittance of toxic gases
2. Toxic particles or gases in the air
3. Dangerous radiation
4. Contamination or empoisonment of water or ground
5. Lacking gray water-, smoke- or waste management
6. Water damage in the construction works. (Boverket, 2022b)

### **BBR chapter 6**

Materials and construction products used in the building must not harm the nearby environment.

#### **Air quality**

The building and its installations should be designed to enable good indoor air quality, the air may not contain pollution on levels impacting health negatively.

#### **Moisture**

The building should be designed to avoid water damage, odors, and microbial growth causing health issues.

Buildings, constructions products, and materials should be weather protected during the construction phase and controlled for water damage.

The climatic barrier should be airtight to avoid water damage caused by moist convection. (Boverket, n.d.)

#### **Theoretical findings**

Raw earth has very low embodied energy compared to other more conventional materials (see page... diagram) and is in its raw form and can be recycled indefinitely.

Earth has no negative impact on human health in any phase, from construction to usage and maintenance, nor in demolition. (Heringer et al., 2019)

A good indoor climate is important for health and comfort. Comfort depends on factors like temperature, humidity, movement, radiation and, pollutants in the air. Raw earth is proven to mitigate differences in temperature and humidity and keep them relatively constant, which is enhancing the indoor climate. Due to the breathing capacity of the material, less ventilation is needed, and therefore there is less movement causing dust in the air. There have even been theories of raw earth absorbing

## Appendix

pollutants in the air, though this is not scientifically proven. (Minke, 2006) But it does absorb smells. (Heringer et al., 2019)

Thanks to its possibility to regulate humidity, raw earth is proved to be more hygienic than baked tiles in bathrooms. The capacity to quickly absorb humidity, inhibiting fungus. (Minke, 2006)

### Conclusion

Many of the requirements specified in PBF are not relevant for the material itself, but rather for the installation of ventilation, water- and waste management. The requirements relevant for rammed earth concerning hygiene, health, and the environment are mainly about air quality and moist management.

Earth has proven to have a very good impact on the indoor air quality as well as regulating moisture very well by absorption and desorption, inhibiting water damage. Fulfilling these requirements shouldn't be a problem, as long as the recommendation of airtightness isn't mandatory. Using airtight layers in the construction of a rammed earth wall will disturb its breathing capacity and further on its good impacts on the indoor climate.

As mentioned in under theoretical findings, rammed earth does not cause any health issues during any phase of its existence. There shouldn't be a problem getting approving tests for this requirement.

The part that all buildings, construction products, and materials should be weather protected during the construction is relevant for rammed earth. This can be economically challenging since ramming earth is very time-consuming and it is expensive to provide proper weather protection for a long period. Therefore, it is once again interesting to look into the topic of prefabricated elements.

## 4. USAGE SAFETY

*Säkerhet vid användning*

### **PBL (2010:900) 8 kap 4§:**

4. Usage safety (säkerhet vid användning).

### **PBF (2011:338) 3 kap 10§:**

*För att uppfylla det krav på säkerhet vid användning som anges i 8 kap. 4 § första stycket 4 plan- och bygglagen (2010:900) ska ett byggnadsverk vara projekterat och utfört på ett sådant sätt att det vid användning eller drift inte innebär en oacceptabel risk för halkning, fall, sammanstötning, brännskador, elektriska stötar, skador av explosioner eller andra olyckor.*

To fulfill the requirement of usage safety, the building must be designed to avoid the risk of falling, slipping, colliding, burn injuries, electrical shocks, injuries from explosions, or other incidents.

(Boverket, 2022b)

### Conclusion

This requirement is not found relevant since this thesis is focusing on rammed earth as a building material. There are other factors to consider when fulfilling this requirement.

## Appendix

### 5. NOISE PROTECTION.

Skydd mot buller.

#### **PBL (2010:900) 8 kap 4§:**

5. Noise protection (skydd mot buller)

#### **PBF (2011:338) 3 kap 13§:**

*För att uppfylla det krav på skydd mot buller som anges i 8 kap. 4 § första stycket 5 plan- och bygglagen (2010:900) ska ett byggnadsverk vara projekterat och utfört på ett sådant sätt att buller, som uppfattas av användarna eller andra personer i närheten av byggnadsverket, ligger på en nivå som inte medför en oacceptabel risk för dessa personers hälsa och som möjliggör sömn, vila och arbete under tillfredsställande förhållanden.*

To fulfill the requirement of noise protection, the construction works must be designed with an acceptable noise level for users as well as people nearby. Noise must not impact health negatively.

#### **BBR (2011:6) chapter 7:1:**

Minimum sound reduction from one room to another ( $D_{nT,w,50}$ ), for dwellings must be at least 52 dB measured from space outside of the dwelling to the inside.

#### **Theoretical findings**

A single leaf wall is considered acoustically sufficient as an apartment dividing wall if the surface density is  $>200 \text{ kg/m}^2$ , a rule of thumb when calculating acoustics. (M, Blasco, lecture, 2021)

$$\text{Surface density} = \rho \cdot d \rightarrow \frac{\text{Surface density}}{\rho} = \frac{200}{2000} = 0.1 \text{ m}$$

To fulfill the requirements of a wall between different housing units, a rammed earth wall must be 100 mm.

Aside from good acoustic insulation properties, rammed earth reduces the reverberation time (reduces echo in a room). Rammed earth has a high surface area with various densities which is good for acoustic absorption. (Lehm Ton Erde, n.d.)

As for concrete, rammed earth is a very heavy material, and sound transfers very well in it. Therefore, it is of great importance to separate the load-bearing structure with resilient layers to avoid structure-borne sound in the building. (M, Blasco, lecture 2021; Lehm Ton Erde, n.d.)

In tests according to Australian standard 1276-1979, 300 mm rammed earth walls have achieved class 57, which means a sound reduction of 57 dB through a wall (unit unknown). (Dobson, 2000)

#### **Conclusion**

Based on the theoretical findings, reaching the requirements of the Swedish standard of noise protection should not be a problem.

### 6. ENERGY EFFICIENCY AND THERMAL INSULATION

Energihushållning och värmeisolering.

#### **PBL (2010:900) 8 kap 4§:**

6. Energy efficiency and thermal insulation (energihushållning och värmeisolering)

#### **PBF (2011:338) 3 kap 14§:**

*För att uppfylla det krav på energihushållning och värmeisolering som anges i 8 kap. 4 § första stycket 6 plan- och bygglagen (2010:900) ska en byggnad*

- 1. ha en mycket hög energiprestanda där den energi som tillförs i mycket hög grad kommer från förnybara energikällor (nära-nollenergibyggnad) uttryckt som primärenergi beräknad med en viktningsfaktor per energibärare som ska bidra till teknikneutralitet mellan hållbara uppvärmningssystem som inte är fossilbränslebaserade,*
- 2. ha särskilt goda egenskaper när det gäller hushållning med el, och*
- 3. vara utrustad med en klimatskärm som säkerställer god värmeisolering.*

In PBF the regulation regarding energy efficiency and thermal insulation is more specified, stating requirements regarding renewable energy sources, enabling good energy management, and a climatic barrier ensuring good thermal properties. Whereas the latter is the relevant one to focus on with regards to rammed earth as a building material.

#### **BBR chapter 9**

Buildings must be designed to enable efficient energy management. The climatic barrier of the building must fulfill requirements regarding U-value and airtightness.

Required U-values:	
Small buildings (ranging from $<50 - >130\text{m}^2$ )	0.30 W/m <sup>2</sup> K
Multiple dwelling houses	0.40 W/m <sup>2</sup> K

BBR 29 further specifies the requirements by defining specific u-values for different components:

Wall	0.18 W/m <sup>2</sup> K
Roof	0.13 W/m <sup>2</sup> K
Floor	0.15 W/m <sup>2</sup> K
Window	1.2 W/m <sup>2</sup> K
Door (exterior)	1.2 W/m <sup>2</sup> K

The climatic barrier must have good airtightness in relations to chosen ventilation system to ensure good airflows and minimize risk of water damage. (Boverket, n.d.)

#### **Theoretical findings**

Rammed earth has a thermal conductivity value ranging 1.1 to 1.4 W/mK. (Grunacker, 2021) A 300 mm wall of rammed earth would have a U-value of  $\sim 4,3\text{W/m}^2\text{K}$  and must be additionally insulated to fulfill the requirements, though it has good properties as thermal mass. Rammed earth helps regulate and mitigate changes in temperature which helps increasing the energy efficiency in the building. (Lehm Ton Erde, n.d.)

Earth had the performance of regulating moist which inhibits fungus growth, read more on page 91.

#### **Conclusion**

Rammed earth itself is not a good thermal insulator and has to be additionally insulated with other materials to fulfill the requirement specified in BBR. Adding additional insulating layers to the construction of a wall, like the construction of concrete walls should not be a problem.

This aspect is easily solvable by choosing good insulating material to add to the construction, and can't be an issue in approving rammed earth as a building material. There is therefore no need to investigate this aspect further in this master thesis.



**CHALMERS**  
UNIVERSITY OF TECHNOLOGY