

Senior Health Park

A health promotive community park for older adults.



Marcela Dzieciatkowska
Chalmers School of Architecture
Department of Architecture and Civil Engineering

Examiner: Johanna Eriksson
Supervisor: Susanne Clase



CHALMERS
UNIVERSITY OF TECHNOLOGY

Senior Health Park: A health promotive community park for older adults.

Marcela Dzieciatkowska

Chalmers School of Architecture

Department of Architecture and Civil Engineering

Architecture and Planning Beyond Sustainability

Examiner: Johanna Eriksson

Supervisor: Susanne Clase

Healthcare

Master's thesis

Spring 2022

ABSTRACT

We live in the times of an aging society. Elderly is often affected by physical and mental diseases, the progress of which may result in the need of full living assistance. Changing demographical composition will limit the availability of such service and change the approach to elderly care. To truly meet their needs and ensure a fulfilling life, planning for their future needs to be started as early as in the close coming years. The challenge we are faced with is complex and requires a wide range of solutions and approaches. One of them is health promotion among the independent elderly which could help them remain healthy and active, reducing their risk of needing living assistance.

A health promotive facility could prove successful if it responds to the multitude of seniors' varied needs, making it easy and engaging for them to use it. This effect can be achieved in a sustainable way by involving them in the design and planning process.

The purpose of the thesis is to explore and develop the idea of a health promotive building project in an existing context, with focus on urban and architectural design aspects related to user experience. The main research methods, namely literature studies, area analysis and design combined with user participation will lead to a deeper understanding of the design factors and tools that contribute to a positive influence of the project.

The outcome of the research is a design proposal of a health promotive facility in Mölndal, Gothenburg. Due to the chosen user-focused approach, the paper will not cover all perspectives in depth. Research with focus on the other stakeholders as well as the technical side is suggested as the next step.

Keywords: health promotion, health promotive design, healthcare architecture, participatory design

STUDENT BACKGROUND



Marcela Dzieciatkowska

m.a.dzieciatkowska@gmail.com

While participating in studios focusing on designing with vulnerable members of society and healthcare for elderly, during my master's program, I began noticing similarities between these two topics. Having learned about the idea of participatory design, I am curious to apply it to health promotive design. I believe that healthcare architecture is a very complex field that requires the architect to balance logical thinking, knowledge building, stakeholders involvement and empathy for users at the same time. A well-developed process is therefore key in achieving good results.

EDUCATION

MSc in Architecture and planning beyond sustainability
Chalmers University of Technology, Sweden
2020 - 2022

BSc in Architecture, Urbanism and Building Sciences
Eindhoven University of Technology, The Netherlands
2015 - 2019

EXPERIENCE

Internship
WillemsenU, The Netherlands
September 2019 - April 2020

Internship
KWK Promes, Poland
July 2018 - August 2018

ACKNOWLEDGEMENTS

I would like to thank my supervisor, Susanne Clase, for supporting me throughout the thesis, offering useful feedback and positive motivation.

I am grateful to my examiner, Johanna Eriksson, for valuable discussions and insight about participatory design.

I would like to show my appreciation to Mikael, Robert, Margareta and Ulrika from Mötesplats Åby in Mölndal. Thank you for your support, help and interest in organizing workshops.

I am grateful to the workshop participants for their enthusiasm and contribution to my work. Your input made my experience of the process exciting and rewarding.

I would also like to thank my parents for supporting me, always being there to listen and cheer me on.

Finally, I would like to thank my friends and fellow students for feedback and help with Swedish.

TABLE OF CONTENTS

1	INTRODUCTION	8
	Purpose	9
	Objectives	9
	Research question	9
	Reading instructions	9
	Background	10
	Methods	12
	Theory	13
	Delimitations	13
2	THEORY	14
	Older adults and elderly	15
	Eldercare in Sweden	16
	Health conditions causing loss of independence	17
	Prevention of disease	18
	The possible goals of a health promotive facility	19
	Health promotion	20
	Health promotive design	21
3	CONTEXT	26
	The site	27
	Analysis	29
4	DESIGN PROCESS & USER PARTICIPATION	36
	The vision and the program	37
	Design concept	43
	Design qualities	45
	Shape and form	51

5	DESIGN PROPOSAL	56
	The site	57
	Buildings	62
	Detailing	69
	Overview	74
6	DISCUSSION	76
	REFERENCES	78
	APPENDIX	82

1

INTRODUCTION



PURPOSE

The purpose of this thesis is to contribute to the field of health promotive architectural design, which may be used as one of the tools in strategies responding to challenges of the aging society. The exploration of the topic focuses on older adults and elderly as the target groups of health promotion that helps them live independently for as long as possible.

OBJECTIVES

The thesis will explore and develop the idea of a health promotive building project in an existing public context on a level of a municipality district. The user perspective will guide the process allowing for the project to respond to the seniors' needs and encourage them to participate in health promotion. The design proposal will include spaces both for professional care and for regular use by older adults.

RESEARCH QUESTION

How to use user-centered architectural design in promotion of health among older adults in an aging society?

READING INSTRUCTIONS

The thesis consists of 6 chapters which represent the entire process of the project creation. The first part introduces the background information, such as the purpose and the research question, methods and delimitations. This is followed by theory, results and conclusions obtained from the studies of literature, statistics and reference projects. The third chapter introduces the project site, the context and results of the analysis. The next part describes the design process and user participation. This chapter aims to show how different aspects, for example the concept or the project program, were developed chronologically with the use of participatory design and knowledge collected before. Afterwards, the final proposal is presented, followed by a discussion and references.

BACKGROUND

The world's population is experiencing several significant transition trends, one of which is ageing. The demographic change is caused mainly by declining levels of fertility and mortality (United Nations, 2019a). In 2019, globally 1 in 11 people were over 65 years old and it is estimated that this number will increase to 1 in 6 by 2050 (United Nations, 2019b). This thesis focuses on the Swedish context, where the change is not as dramatic, however still significant in relation to the global statistics. According to Statistics Sweden (SCB, 2018) nearly 1 in 5 people in 2017 was 65 years old or older. They predict that by 2070, 1 of 4 people will belong to this age group.

These changes will affect all of us to some extent as the system we live in may not continue to function the same way due to shifting demands and resources. One of the biggest challenges to come will be provision of healthcare for all age groups, especially the older adults and elderly (United Nations, 2019b). Even though more people live longer, many do not stay in good health, experiencing chronic diseases and struggling with disabilities (World Health Organization, 2020). This trend has already been negatively affecting the Swedish elderly care system for many years, forcing it to restrict the services to the seniors with the highest care needs (Schön et al., 2015). In the future, access to facilities such as assisted living homes may become extremely limited.

One of the strategies that can be used to reduce the strain on the healthcare system and to minimize the risk of needing assistance late in life is health promotion. By leading a healthy and active lifestyle, older adults can prevent or slow down the progress of some conditions that make them dependent on the constant provision of care (Lindwall et al., 2007). Above all, it means they could live mostly independently and age in

their own homes, close to their relatives and in a familiar environment. Promoting health among elderly and possibly changing their lifestyles are processes that need to be well-planned from all perspectives in order to be truly successful (Kemmm & Close, 1995). Good architectural design and urban planning may increase exposure of older adults to the new measures, encourage them to participate as well as increase the efficiency of potential new facilities. Since it is essential that access to health promotion is easy and context-based (Kemmm & Close, 1995) this thesis will focus on a local scale of one of the districts in Mölndal, Sweden. The entire planning and design process seeks to contribute to a context-based proposal of an intervention that has a high potential of helping our elderly remain independent and active in the community. Focusing on the main user perspective means that the new health promotive spaces will respond to their varied needs and attract them while offering professional help in staying or becoming healthy.



Västra Götaland county

Mölndal

METHODS

The thesis is a combination of Research for Design and Research by Design, and is a result of several methods combined. All of them support and build up on one another, allowing for the process to be an exploration.

SITE ANALYSIS

Urban and architectural site analysis of Mölndal is used to select a specific district for which a design proposal is developed. The district, namely Åby, is analyzed regarding different aspects that may influence the outcome of the intervention. This method used several sources for obtaining information, such as site visits, online maps, statistics, existing analyses as well as personal contact with local residents.

LITERATURE STUDIES

Literature is the main method of obtaining knowledge about the healthcare perspective and aspects forming the base of the project, such as elderly's health issues and needs, health promotion planning and its relation to urban and architectural design. It is also the main source of information about the Swedish system of eldercare as well as studies specific for the local context.

REFERENCE PROJECTS STUDIES

Since active health promotion for elderly has not been very common for a long time, there are not many existing projects built with this purpose in mind from the beginning. However, many buildings built as community centers and healthcare facilities include health promotive ideas for older adults. Analyzing the building process, the facilities' program or how they work give valuable insight into the practical side. What is more, some of these projects

provide information about their outcomes and success of health promotion allowing for reflection on design decisions. This method, however, is complementary to the literature study and focuses only on selected parts of the project.

PARTICIPATORY WORKSHOPS

Participatory design is a way to involve main users (older adults and elderly) both in the research and the design process. They offer valuable insight into the local life and have the best understanding of their own context. Including them as active stakeholders in this project means that they are able to contribute to the creative aspects with their ideas, making the final proposal better suited to their specific needs.

DESIGN

The creative process in this thesis includes an explorative dimension, thus used as a research method as well. Sketching and testing ideas leads to new conclusions and solutions. The result is a design proposal, however emphasis is put on the process and decision making, aiming for them to be logical and informative for a reader of the thesis.

THEORY

The theoretical references in the thesis come from credible sources and include scientific articles from journals, books and official websites of Swedish and international organizations specializing in fields related to this research. In Sweden, there are several large ongoing studies that focus on elderly's health and lives which publish reports and articles about their findings - these have often been used as a way of obtaining a better understanding of the national context. A large portion of statistics also comes from the reports released by the Swedish and global agencies which collect data.

DELIMITATIONS

Since the thesis focuses on the experience and insight of main users as a key part in the design process, it will not cover all potential stakeholders' perspectives in detail. The emphasis is put on the older adults and elderly who live independently (or with little assistance) as they are the main target group of health promotive measures described in this paper. The need finding process is short due to plenty of resources available, including thorough studies about these age groups both in Sweden and in Gothenburg. These are assumed to be representative of the context of Mölndal when there is no data specific for this municipality available.

The scale of the project is small, allowing for in-depth research as well as user participation, which will result in a clear process that can be adapted and applied in different contexts. Since the idea of such as facility is quite new, the emphasis remains on the process rather than a detailed design proposal.

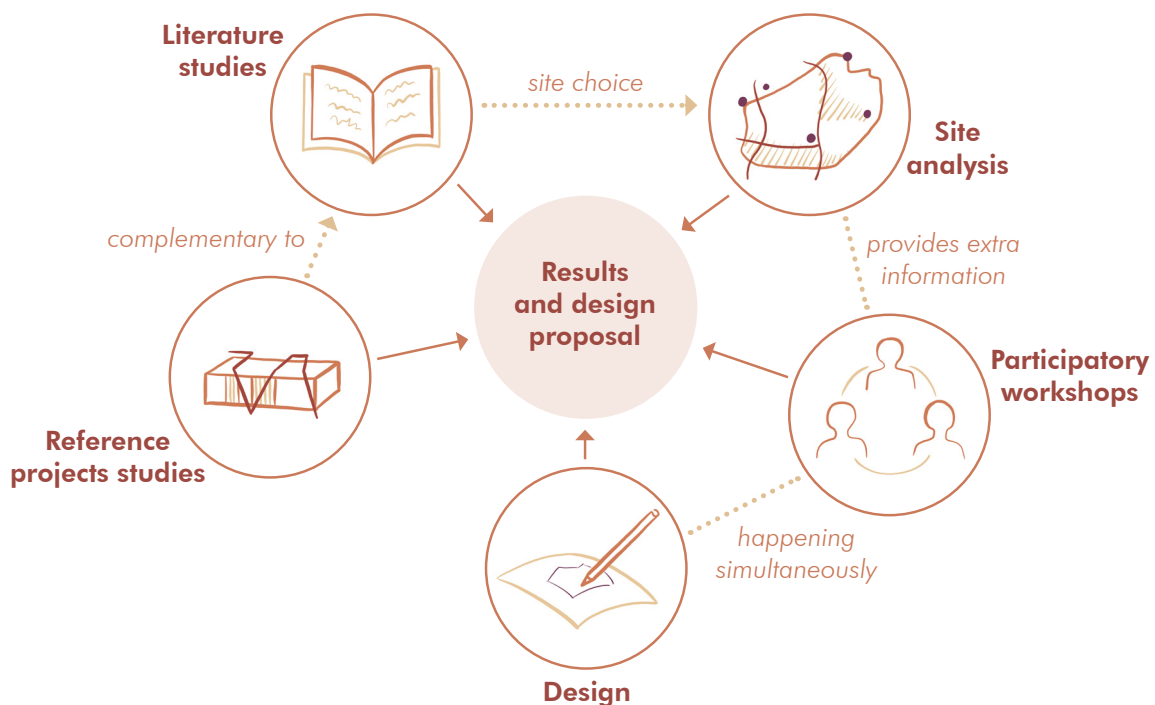

Methods used in the thesis and the relations between them.

2

THEORY

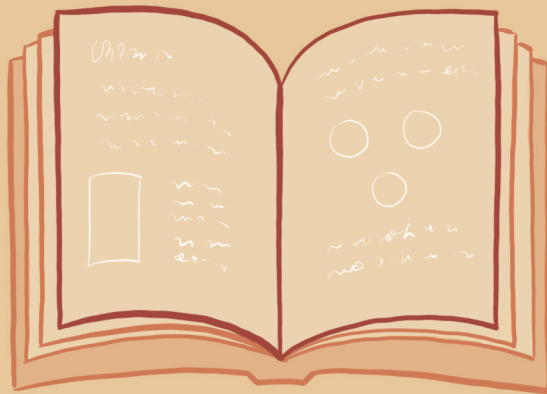

OLDER ADULTS AND ELDERLY

WHO BELONGS IN THE TARGET GROUP

Aging is a process that is not equal for everyone, making it difficult to specify an age span at which someone is considered to be older, yet still able to prevent becoming sick for many years and needing extensive assistance. There are many factors that influence how early one's organism starts to go through biological changes characteristic for advanced age (Lennartsson & Heimerson, 2012). That means that the target group of the design proposal developed in this thesis is not strictly defined in terms of age, allowing for the person's health background to decide whether they belong to "older adults" or "elderly". In the case of this project, assuming that 65 years old (average retirement age in Sweden (Pensionsmyndigheten, 2022) commonly used to define seniors) is a point at which someone needs support and guidance in keeping their living independence could potentially exclude some people, for instance those, who are 60, yet experience clear signs of advanced aging.

When it comes to defining a top age bracket for the target group, the situation is similar and strongly depends on how independent a person still is and what their doctor's advice is (if they are under constant care). Someone with already existing advanced physical conditions might benefit from mental health promotion allowing them to keep some parts of independence for longer. Therefore, rather than using a specific age group, the target users in this thesis are described with the term *older adults and elderly* which is less exclusionary and more inviting for those who will be interested in using the new facilities. It also aims to suggest it is never too early for older people to start working towards keeping their full independence for as long as possible.

LOSS OF INDEPENDENCE

As mentioned earlier, the fact that people live longer nowadays, does not mean they stay healthy and independent equally longer (World Health Organization, 2020). In the article about elderly's health in Sweden written by Lennartsson and Heimerson (2012) attention is drawn to the age of 80 being the average moment after which people start needing more assistance with personal care. A significant share of people aged 85 and more needs help to some extent, with showering and bathing being the first activities they struggle with.

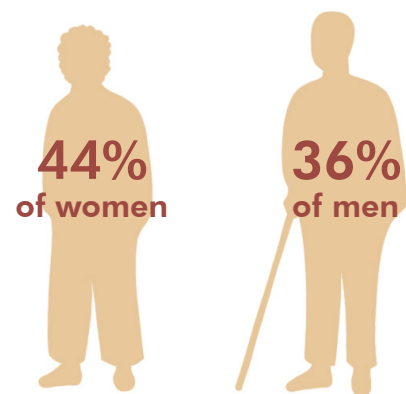

aged 85 or more
need personal care assistance.

(Lennartsson & Heimerson, 2012)

ELDERCARE IN SWEDEN

The Swedish elderly care is a part of the country's welfare system, aiming to provide subsidized services for those who need them, with equality of access being fundamental (Schön et al., 2015).

TYPES OF CARE

In the research from Schön et al. (2015) the public care for elderly in Sweden is divided into two forms, the first one being assistance at home. This includes help related to tasks in a household, such as cooking, and assisting in personal care. This type of care may also include healthcare from the nursing team in the area. The second form of eldercare is provided in the institutions. In spite of the system being expanded until the 1970s, in the 1980s the provision of care started becoming less accessible due to the population aging, affecting especially older adults needing less assistance - the target group of this project.

AGING AT HOME

Even though a large proportion of elderly live their last years in an institution, such as an assisted living home, it is a scenario avoided by the Swedish care system for as long as receiving help at home is possible (Schön et al., 2015). This is, to a large extent, likely caused by the inability to respond to the existing demand (Lennartsson & Heimerson, 2012). The shift in the last years can also be clearly seen in the graph on the right. According to Sveriges Kommuner och Regioner (2020) this allowed for avoidance of very high costs that would have arose if the provision of care remained the same as in 2000. Thus, the idea of aging at home is quite strong in Sweden. Very often, that means involving younger family members in the care process or the affected person's spouse - usually women as they tend to live longer (Lennartsson & Heimerson, 2012).

People aged 80+

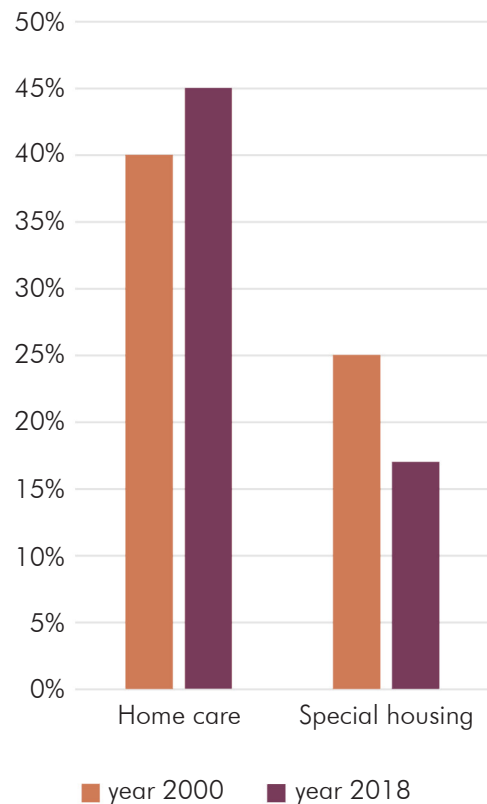

Change in the share of people aged 80+ who received elderly care via home care or special housing. Based on data from Sveriges Kommuner och Regioner (2020).

HEALTH CONDITIONS CAUSING LOSS OF INDEPENDENCE

There is a number of common health conditions that contribute to the Swedish older adults gradually losing independence when they age. Many of these are closely interlinked and have common causes. First of all, most older adults' cognitive function starts to decline when they age, which is one of the main elements in predicting development of dementia (Lindwall et al., 2008). According to research by Lennartsson and Heimerson (2012), elderly is at a higher risk of developing mental health conditions of various severities, for instance anxiety or serious psychiatric disorders. These can be caused by several different factors related not only to biology but also to social or psychological circumstances, and may be some of the symptoms of early dementia. This condition is commonly the reason why elderly people need assistance and lose their independence, with about a half of sufferers living in special housing. In fact, these institutions are used mostly by patients affected by dementia.

Cognitive disorder can also influence other health problems, which lead to dependence on others' help, such as fall accidents (Lennartsson & Heimerson, 2012). Injuries caused by falling, such as fractures, often lead to a significant decrease in health of elderly (Witt et al., 2018). Sweden has drawn attention to this issue as well as to its relation to occurrence of pressure ulcers and malnutrition in Senior Alert (Lannering et al., 2016). As explained in the report by Sveriges Kommuner och Regioner (2020) the possibility of experiencing those problems is high among those who were assessed while receiving home health care, with 83% being at risk of falls, pressure ulcers, oral health problems and malnutrition. All of these are closely interlinked and together may lead to serious issues affecting one's independence and quality of life even more.

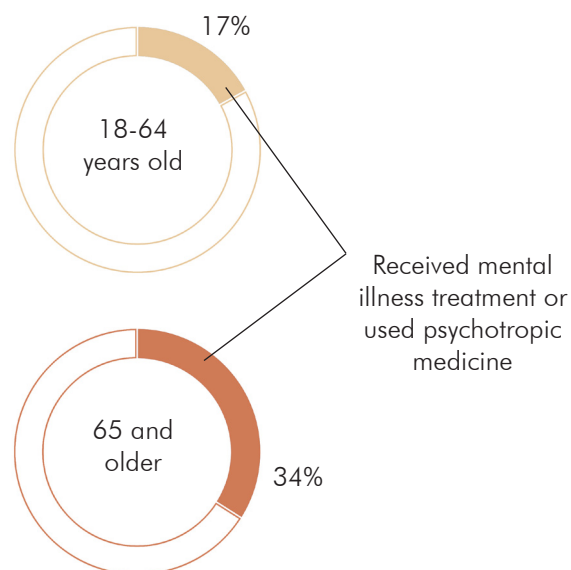

Comparison of the proportions of people who received mental illness treatment or used psychotropic medicine in two age groups, in 2016. (Socialstyrelsen, 2018)

“A person who has problems with oral health eats less, which increases the risk of involuntary weight loss with an increased risk of falling and getting pressure ulcers.”

(Sveriges Kommuner och Regioner, 2020, Förebyggande arbete inom äldreomsorgen section)

Another condition that commonly contributes to development of disability and loss of independence is cardiovascular disease, especially strokes according to the research by Lennartsson and Heimerson (2012). Not only do they cause impaired mobility, but may also cause or worsen the symptoms of dementia. Cardiovascular

diseases also have a number of risk factors related to other conditions, for example diabetes or hypertension. Being overweight is often also related and quite common in Sweden, as according to Lennartsson's and Heimerson's research (2012) more than 50% of retired Swedes are affected by it.

PREVENTION OF DISEASE

As shown in the previous chapter, many of the poor health conditions affecting the elderly are related to one another, with one person being likely to struggle with several of them. That means prevention needs to be directed at multiple diseases and risk factors. Often, one preventive method, such as physical activity performed on a regular basis, can prove successful in reducing the risks of many diseases according to the research by Lindwall et al. (2007). It has also been observed that this type of exercise is, in fact, one of the most significant factors that contribute to aging in good health. Regular and moderate (rather than high-intensity) physical activity may positively influence not only physiological and mental health, but also emotional and social well-being of an older adult according to another research by Lindwall et al. (2008). Remaining mentally active and participating in social activities have also been tied to healthier aging of older adults in the SNAC-Kungsholmen Population Study (Stockholm Gerontology Research Center et al., n.d.). What is more, the study has found that even for people aged 75 and more, a healthy lifestyle and participation in social life is associated with better health.

In research from Lennartsson and Heimerson (2012) in addition to preventive methods described in the previous paragraph, attention is drawn to other lifestyle habits that influence development of existing disease and decrease the risk of acquiring new conditions by an elderly individual. These relate to a healthy diet, lower alcohol consumption and no smoking.

Contact with medical professionals is also crucial in preventive care according to Lannering et al. (2016) who describe Senior Alert in Sweden. The assessment of risks typically performed by nurses and followed by cooperation with different specialists results in a possibility to include extra measures under their control. The process also has an educational effect. In addition, the data collected in the program is shared with the Swedish government and allows for better planning of elderly care in the country (Edvinsson et al., 2015).

Lastly, Senior Alert suggests that solutions which adapt the physical environment to the needs of people prone to fall accidents may prevent them from happening (Witt et al., 2018).

THE POSSIBLE GOALS OF A HEALTH PROMOTIVE FACILITY

Since the project's aim is to promote health among older adults and elderly to help them remain as independent as possible while they age, it should try to encourage them to engage in the preventive activities described in the previous section. The graphic below summarizes and rephrases them in order to serve as overall goals of a health promotive facility designed in a local context. The way these will be approached and prioritized should depend on the factors explained in the next section (health promotion planning on a local level).

Because the project will be located on one site and aims to promote health among the local society of older adults mostly at the location, it cannot directly affect the physical environment of the entire area. It can, however, be an example of an age-friendly design.

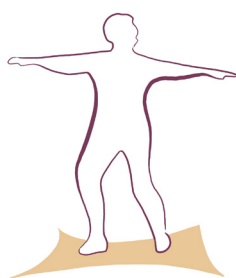

Encourage regular physical activity

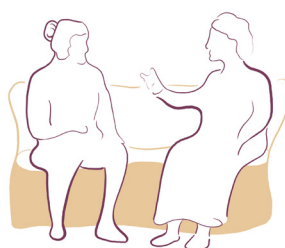

Encourage social activity



Promote mental well-being



Promote healthy eating habits



Encourage limiting of smoking and consumption of alcohol



Offer professional medical support



Be an example of age-friendly design

The possible goals of a health promotive facility

HEALTH PROMOTION

Healthcare architecture is very complex as it is combined and interacts with other fields. Therefore, understanding how health promotion is usually planned and how to encourage people to participate as well as what the current steps taken in Mölndal or surroundings are, is crucial for this project. These will form a strong basis for a design vision and concept that respond to the local context and strategy, and help specify how urban and architectural tools may contribute to promotion of health among elderly. To facilitate the design process, my research in this section is focused on the target group and the goals identified in the previous section.

HEALTH PROMOTION PLANNING ON A LOCAL LEVEL

Kemm and Close (1995) have written a book about theory and practice related to health promotion. In a very informative chapter about planning this type of care in a local context, they explain that collecting different kinds of data and understanding the user are a basis of the process. Many of these apply to older adults being a target group: types and frequency of health conditions, people's lifestyle, their attitude and knowledge about health as well as sources of such information, local environment and possible resources. This data should be as local as possible, however sometimes it may not be available and then national sources need to be used. In Sweden, this step in health promotion planning is of high importance as well, which can be seen, for example, in the basic evaluation report from Gothenburg City (Göteborgs Stad, 2019). The document is a basis for the city's strategy to become age-friendly and may also be representative of the situation and users in Mölndal.

That step, according to Kemm and Close (1995),

allows for better selection of priorities and setting aims and objectives in a health promotive process in a local setting. Based on those, a variety of options is chosen and implemented, followed by constant evaluation.

HOW TO ENCOURAGE PARTICIPATION

Health promotion is about being proactive and often involves a social factor, such as doing some activities together as mentioned in the report by Sveriges Kommuner och Regioner (2020). Kemm and Close (1995) list several factors and actions that could encourage older adults to actively use the new facility and be interested in its offer:

- Building knowledge about consequences of their lifestyle
- Offering activities that bring enjoyment, making them interesting for this age group
- Giving motivation or rewards - such as a promise of positive results of regular exercise
- Reducing stress of the users, showing them it can be done in a healthy way
- Making space for social activities, creating interaction
- Advertising
- Supporting and helping them create a positive self-concept of themselves

SWEDEN AND MÖLNDAL

Sveriges Kommuner och Regioner (2020), in their report about elderly care, explain that health promotion (for those elderly who are still independent) in the country is often a collaboration between municipalities, supported by the society. It aims to be natural and integrated, not always medical but rather social and pleasant. The national values, focusing on dignity and well-being, as well as available quality registers give a direction for municipalities to follow.

Attention is also drawn to facilitating early diagnoses, offering opportunities for rehabilitation and using new technologies. In the future care, they plan to involve more professionals from different fields, for example counselors or health educators.

The Municipality of Mölndal, where the site is located, offers many kinds of support for older

adults of all ages (Mölndals Stad, 2022c). This includes help provided at the help and care administration, and activities that promote health in an enjoyable way. These are usually organized at the local community meeting centers and points distributed around the municipality. All activities are presented in a calendar available on the website. Some examples include fitness, yoga, playing games or learning languages.

HEALTH PROMOTIVE DESIGN

There is a number of health promotive design approaches and tools to be used on different scales, often dependent on the specific function of a project or its target groups. This chapter will present the theoretical findings related to the topic from a bigger, urban scale to more detailed architectural principles, as well as two reference projects from other countries in Europe.

USER PARTICIPATION AND CO-CREATION

Since collaboration with all stakeholders is becoming an essential part of the planning (Sveriges Kommuner och Regioner, 2020), involving future users in the process and understanding their needs has even more potential to contribute to a successful result. As explained in the toolkit by Western Australian Council of Social Service (2017) the target group knows their environment very well, which makes them valuable experts in this area. By working closely with them, a designer is able to shape new facilities in a way that makes them more effective. Furthermore, the co-creation process empowers the users by involving them in the decision making and offering them control over their surroundings. It also results in new interactions,

unique ideas as well as creative problem solving. Users who participate in creating the project may also feel more engaged in the whole process and continue to develop or maintain new spaces while they're in use. Seniors in Gothenburg have already been successfully involved in the planning process and want to keep on contributing (Senior Göteborg, 2019).

CHOOSING A LOCATION

If the project does not have a specified site within an area (such as a neighborhood or district) and rather aims for this choice to be a part of the design process, there are a few important factors to consider. First of all, as health promotion needs to be easily accessible and visible, the new facility should be located close to older adults' homes (Kemmm & Close, 1995). However, assuming that one of the many local primary care units (such as Närhälsan) is a good choice might not be wise. People tend to prefer a rather informal setting to receive health advice - feeling comfortable is key in having a discussion about one's well-being (Kemmm & Close, 1995). This is an important part to consider when making a decision about the location, especially because health promotive

actions do not always need to be medical as explained in the previous chapter and mentioned by Sveriges Kommuner och Regioner (2020).

Additionally, with reference to the previous section, it is crucial to consider which location facilitates collaboration that will be needed to run the new facility. It should encourage the society to participate actively, while also allowing for easy cooperation with professionals, such as physiotherapists or educators (Sveriges Kommuner och Regioner, 2020).

Finally, as can be concluded from the previous chapters, the location of the facility needs to respond to its goals specific to the target group listed on page 19. Combining architectural and urban design knowledge with good understanding of the target group may contribute to meeting those goals from the very start of the process.

AGE-FRIENDLY DESIGN

World Health Organization has introduced a vision of an age-friendly world where older adults can age in an active and healthy way (World Health Organization, n.d.). They draw attention to the spatial and social environment of the cities that can be transformed and developed step by step together with the inhabitants. This or similar initiatives have found interest in many countries which actively try to contribute to the vision, for example Canada (Public Health Agency of Canada, 2015). In the evaluation guide from 2015 published by Public Health Agency of Canada, a chapter is devoted to outdoor and built environment which influence the lives of older adults' to a large extent. First of all, they list features related to walking that make this activity safer and more accessible for the target group. These include regularly positioned resting spots and bathrooms that should also be considered in this thesis project. Designing safe paths is another essential element of the process and may involve

any features that contribute to their safety, such as good lighting or appropriate width. Related to that is good accessibility for all those who may not be able to use stairs. Not only does it mean that the ground floor level should be easy to enter, but also that enough space should be left for wheelchairs or other help vehicles.

The example above proves how crucial it is to make well-informed design decisions and test them during the entire process to see how they contribute to age-friendliness of a project. This applies from the very start until the last details.

BUILDING PROGRAM

The building program should focus on the goals listed before, so, in other words, facilitate physical activity, social interaction and care (including educating). Staying physically active for older adults, as explained before, is about regularity with moderate rather than high intensity. The exercise may include, for example, walking, balance training, aerobic workout for strengthening muscles (Taylor, 2014). Therefore, the proposal should include spaces which allow both for the use of equipment (such as a gym) and for organizing sessions led by professionals who can show older adults how to use the facilities and modify them specifically for their needs (Scott et al., 2014).

Spaces that facilitate social interaction will depend on the needs and preferences of the target group to a large extent, however flexibility is key to allow for constant development and new ideas. Seniors in Gothenburg have expressed interest in organizing activities and volunteering (Senior Göteborg, 2019), so the buildings could have a co-creative environment to respond to that need. According to Kemm and Close (1995) health events are one of the ways to encourage participation and offer a variety of social activities. These may be of large or small scale, including, for example, storytelling sessions or

exhibitions. Therefore, comfortable spaces that are easy to adjust as well as plenty of storage are necessary qualities. The authors also draw attention to standard community meeting places, such as libraries. The new spaces could make use of these familiar elements and offer similar features, such as a small book corner/exchange or a café.

An example of a community meeting place built for older adults is Falcognana Elderly Center designed by IaN+ and built on the suburbs of Rome (ArchDaily, 2012). The building facilitates social interaction and encourages the users to spontaneously develop activities with the use of an open floor plan and plenty of attractive outdoor spaces with different levels of privacy. The architects established a close connection of the interior with the exterior surrounding nature, where other amenities are located, for example walking paths, squares, gardens or sport facilities as shown on the site plan on the right. This way the entire area becomes an attractive place to visit for elderly and promotes a healthier and active lifestyle.

During the events or specified hours, health check-ups could take place in a separate room, focusing on the heart and mental state of older adults, as diseases related to those commonly cause loss of independence as identified before. There will also be a need for a space that can be used to offer educational materials or activities. Kemm and Close (1995) mention several media that can be used for those, including small objects such as posters and larger ones, such as projectors. This type of place could also collect information, concerning older adults, in one location, as some of them find that easier, especially if there is someone available to answer any concerns at the same time (Senior Göteborg, 2019). Designing spaces that may be used for these purposes will be one of the health-promotive aspects in the proposal.



Falcognana Elderly Center - site plan. Illustration by IaN+ (2012).

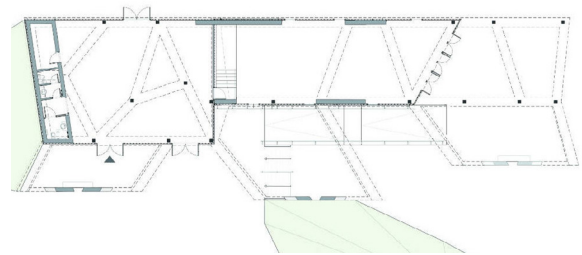

Falcognana Elderly Center - ground floor plan. Illustration by IaN+ (2012).



Falcognana Elderly Center. Photograph by N. Marziali (2012).

PROFESSIONAL CARE

Since care provided by specialists (for example physiotherapists or geriatricians) is an important part of health promotion, the new project could encourage the target group to use it and facilitate its provision. However, as can be concluded from the report by Sveriges Kommuner och Regioner (2020), in Sweden there are currently no specific or advanced plans of building a new type of care suited solely to elderly. At the moment, the focus rather remains on using the existing facilities, which would appear more sustainable. An interesting and innovative approach may be observed in Kingston Upon Hull, England where the authorities opted for creation of a new medical centre for older patients to use instead of hospitals in long-term care (ArchDaily, 2019). The Jean Bishop Integrated Care Centre designed by Medical Architecture is a part of the response to the aging population challenge, and offers a unique and efficient way of health services provision. Designed with input from users and opened in 2018, the project has since been very successful (NHS Hull Clinical Commissioning Group, n.d.-a, n.d.-b). Emphasis was put on prevention of disease and health promotion to help the elderly live independently longer. In design, the emphasis was put on creating a welcoming and warm environment for the visitors to feel relaxed and well taken care of, in contrast to the less comfortable and pleasing experience of a traditional hospital. The building includes many small rooms used for consultations and diagnostics which are arranged around a green courtyard as shown on the floor plan. Multiple gardens encourage the visitors to move around, while the waiting areas are designed as social spaces for interaction (ArchDaily, 2019). Just as in the previously introduced project, the designers created a variety of interesting spaces to explore, to walk through and to interact in. Combined, they contribute to promoting an active lifestyle.

Even though the centre is larger than this thesis project, it offers inspiration for the Swedish context and proves that a new type of care may, in fact, be more sustainable as a solution to challenges posed by the aging society. Slow introduction of a similar idea could therefore prove beneficial in Sweden.



The Jean Bishop Integrated Care Centre - site plan. Illustration by Medical Architecture (2019).

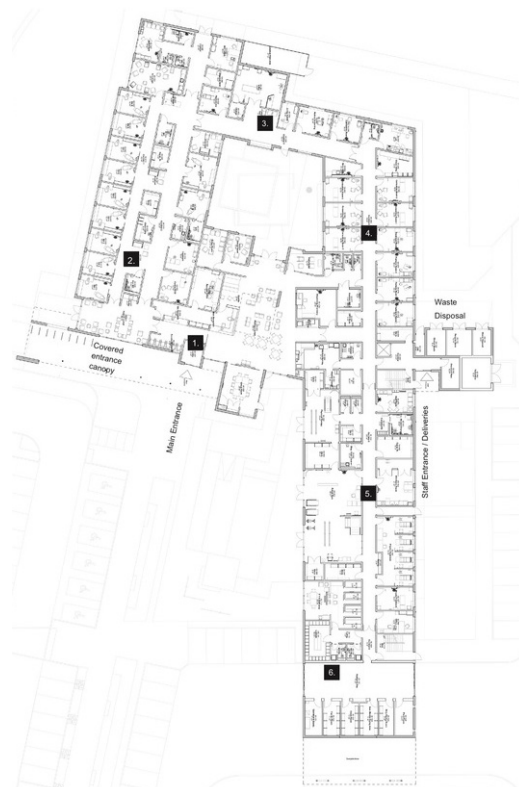

The Jean Bishop Integrated Care Centre - ground floor. Illustration by Medical Architecture (2019).

SENIOR PARK

All the functions should come together as one, interact and support one another, forming an attractive place for older adults. One of the existing ideas that have a similar approach and goals is a senior park described by a landscape designer Arja Paula (Paula, n.d.). It is a type of park that offers multiple functions for elderly that bring them together and encourage them to remain active. Although the target group she describes is older and less mobile, many of the features described apply to this project as well. She explains how important it is for a designer to take into account that older adults experience some things differently due to existing health problems related to aging, such as

visual problems. It is therefore always essential to evaluate and readjust every design decision, for example distances between different objects, benches height (they should be higher than standard) and hand rests, use of colour themes or contrast for better orientation.

SUMMARY

The new facility for older adults and elderly will need to combine a large variety of design solutions and tools that together contribute to health promotion and increase the potential of the project becoming successful. These will be developed further in context during the design process. Below, an overview based on the previous sections is shown.



Participatory design:

- included during the design process
- making the building flexible to allow for further development by users



Location:

- close to users' homes
- in an informal setting
- with good access for employees (e.g. doctors)
- responding to goals specific for the target group (page 19)



Age-friendly design:

- accessibility (e.g. wide paths, low thresholds, plenty of space for aids)
- walkability (e.g. safe paths, good lighting)
- safety (for instance from falling)
- plenty of seating options
- access to bathrooms
- careful detailing adjusted to the age group



Building program:

- space for individual exercise (gym)
- space for exercise sessions with a professional (open area)
- flexible spaces
- plenty of storage
- familiar meeting spaces for interaction (e.g. café or hobby area)
- space for educational materials or activities
- consultation and diagnostics rooms



Other:

- comfort (e.g. a variety of seating options)
- attractive outdoor space
- varied levels of privacy
- open floor plan in some parts
- welcoming and warm design
- careful and constant consideration of possible interactions and enhancing this effect
- adjusting details to elderly and the way they may perceive their surrounding when experiencing different health conditions (e.g. considering step heights, distances, colour contrast or clear orientation)

Overview of design solutions, tools and ideas that may be combined for the project to promote health.

3

CONTEXT

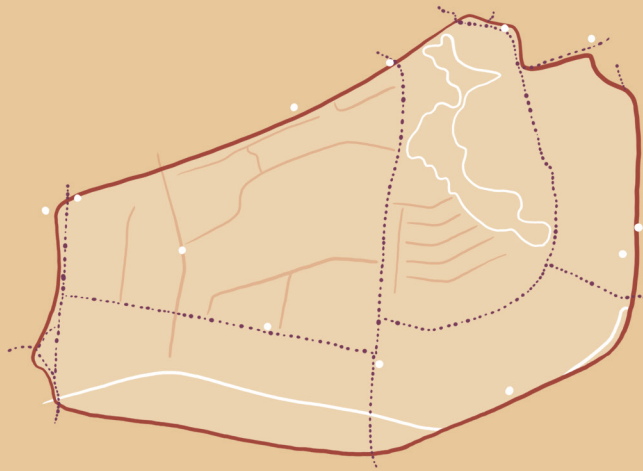

THE SITE

CHOOSING PROJECT LOCATION

The location choice is, in a way, a part of the design process in this project. It was based on the research results from the previous chapter and on my educational and work experience in architecture.

Since the new facility is a rather uncommon idea in Sweden and will have to offer a good setting for different stakeholders to collaborate while being able to reach as many older adults as possible, I decided to start by exploring Mölndal through different site visits. The locations of different meeting points for elderly listed on the municipality's website (Mölndals Stad, 2022b) directed me towards places that are visited by older adults. Visiting them myself as well as walking through the city provided me with a better understanding and ideas of possible locations. It also resulted in creation of general criteria that have the potential to increase the success of new health promotive facilities. These

included enough space for a variety of functions, easy access by all modes of transport, possibility of social interaction, relation to other facilities (such as primary care), access to services and shops, connection to nature, safety (for example, low risk of vehicle related accidents). It was also important to check for any existing health promotive facilities to allow for possible cooperation or extensions. Site visits were the most reliable tool in assessing the criteria for each location I visited. In addition, maps offered by Mölndal municipality (Mölndals Stad & Lantmäteriet, n.d.) were helpful in identifying existing facilities and distances.

The area (a park) near one of the community meetings points - Mötesplats Åby, has met all the criteria listed above, resulting in a decision to locate the facility there. This was followed by establishing contact with the community center and conducting a structured analysis of the chosen districts of Mölndal, in order to develop a strong design concept.



Location of the chosen district (Åby and neighbouring Broslätt) in relation to Gothenburg and Mölndal. The site is marked with the dark point.



Mötesplats Åby

View from a hill in the park towards Mötesplats Åby. On the right there is an obstacle course and behind it - playing fields for children, next to a school.



View towards a side of the hill. The height differences are visible, creating a variety in the terrain that adds depth to the landscape and makes it interesting.

ANALYSIS

The site is located in Åby, a district positioned next to the inner center of Mölndal. For the analysis, I focused on a bigger area first - Åby and neighbouring Broslätt, which are surrounded by bigger roads, creating a border. The users of the new facility would most likely live in this area, which was also confirmed during my first workshop with elderly.

NUMBER OF OLDER ADULTS

The Municipality of Mölndal did not provide me with statistics regarding the number of older adults living in the two districts. However, it was possible to obtain an approximate number based on the number of people who are eligible to vote in the municipal council elections (Valmyndigheten, 2018). In 2018 there were around 1000 people aged 65 or more living in Åby and Broslätt, constituting approximately 22% of the population that can vote (adults).

ACCESSING THE SITE

The map on the next pages shows different ways of accessing the site: by using the roads, walking, cycling or using public transport (buses). The infrastructure is quite well developed and allows for easy access from Gothenburg as well. In the immediate vicinity of the site, there are only paths for pedestrians and cyclists, resulting in the increased safety and improved walkability.

THE HEALTH PATH







An important element of the existing health promotive features near the site is the Health Path - a walking and exercise trail of 6 km, that runs through Mölndal. It encourages the users to experience the natural and urban parts of the city. The idea is in use in several European countries and aims to promote health, with

focus on cardiovascular disease prevention (Mölndals Stad, 2022a). On the next pages, a part of the path is shown - the site is located in a corner it forms.



Entrance to Mötesplats Åby, the bicycle and pedestrian path in front of it. Even though their quality is high and contributes to the car-free environment to a great extent, it cuts the meeting centre away from the park. The grey facade does not stand out in a way that would attract more people in.

Åby and Broslätt - the area of Mölndal where the site is located, surrounded by traffic intensive roads.
Based on data from Mölndalskartan (Mölndals Stad & Lantmäteriet, n.d.).

-  - Roads, access for cars
-  - Pedestrian-only paths
-  - Cycling paths
-  - Health path (Hälsans Stig)
-  - Bus stops
-  - The site



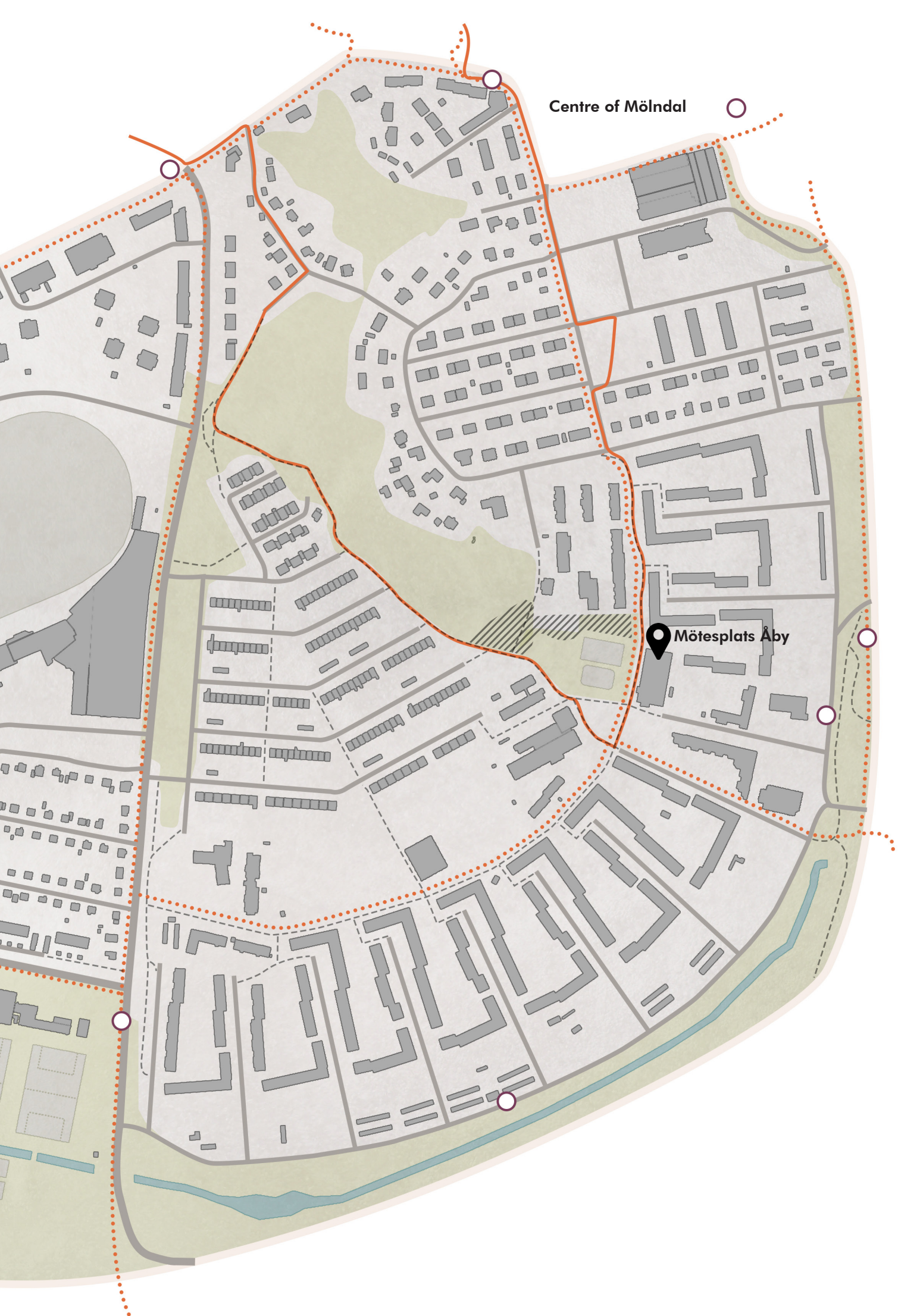

Centre of Mölndal

Mötesplats Äby

Åby and Broslätt - building functions map in relation to the topic. Based on data from Mölndalskartan (Mölndals Stad & Lantmäteriet, n.d.).

- - Residential
- - Other
- - Supermarkets, restaurants
- - Schools, pre-schools
- - Medical facilities
- - Accessible sport facilities
- - Park

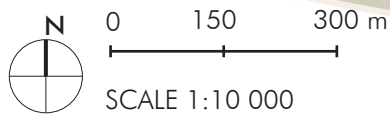

FUNCTIONS IN THE AREA

As can be deduced from the map above, most of the built structures are for residential purposes, including both houses and living blocks of several floors. Near the site, there are multiple schools, making the area very lively during teaching hours. There are also a number of sports facilities, however none of them are aimed at

older adults. The site is located at the end of a natural park - a green stripe that continues towards North and the city. On the eastern side, very close to the new spaces, there are medical facilities - a hospital, medical centre and emergency.

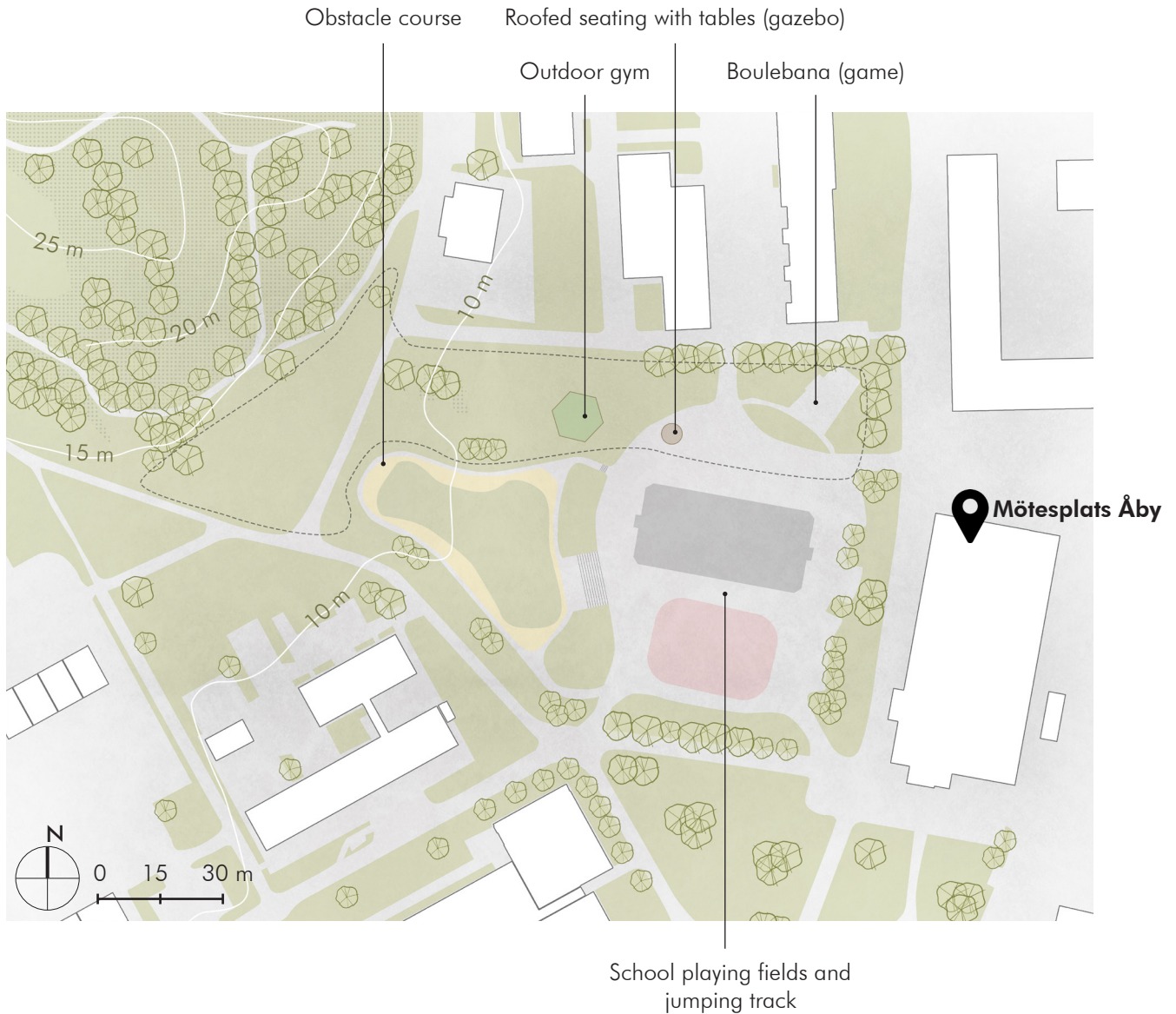

The site and its immediate surrounding, trees and terrain.

- Areas marked as "naturmark" or transitional zone of nature
- The site - potential area that could be used for design

THE SITE'S IMMEDIATE SURROUNDING

The site is located in a transition zone from the urban landscape into a natural park. One of the reasons I chose it was the existing facilities that could be included in the design proposal and used as health promotive features. This includes a newly built outdoor gym, old seating under a roof and Boulebana (see photos on the next page). The site is neighbouring sports facilities used by

the schools, offering potential for activities encouraging interaction between elderly and children. The concrete surface and a rather rough design around the sports fields and the jumping track results in the loss of natural atmosphere of the location. The western part of the site is affected by terrain elevations, posing a design challenge with a potential for a unique, context-based proposal.



Concrete surface around the fields.



The obstacle course.



The old gazebo in a bad condition.



Boulebona.

THE DETAILED PLAN

The plans for development of the area where the site is were created in 1963 and 1969 (Östnäs & Leufstadius, 1963; Partheen, 1969). The older one concerns the whole area analysed in this chapter, while the second one is focused strictly on the site and the neighbouring buildings. Even though there are small differences between them, both plans mark the location of this project as a park, which then should continue all the way to the eastern side of the

district, where the waterway is. This way, there would be a green stripe going through the city. However, in the past 50 years many changes were accepted as can be concluded from the current maps, where new buildings (such as the medical facilities shown before) and sports fields were added. This results in an impression of the park ending near the obstacle course.



The newly built gym.

CONCLUSIONS

The site is located in a very well accessible area nearby the centre of Mölndal, so it has a high potential to reach many residents. This quality could be used in the design, and might also contribute to promotion of health - for example by encouraging the target group to use the well developed bike infrastructure and cycle to visit the new buildings. Since the immediate surrounding of the site is car-free, the area is very safe. Keeping the safety will be crucial in the design process, for example while considering possible paths of deliveries for the facilities.

The Health Path could be included in the design, however it should not be disturbed by it, but rather become a complementary part of health promotion. The site of the new buildings is located in a corner where the path turns, making for an attractive location where the users of the path walk (or run) around the new facilities.

The medical facilities located nearby the site could become a source of professional support in health promotion. Mötesplats Åby could have a similar role and should be included in the design proposal - it already has a good view towards the park, overlooking the new project.

The site is located in a transition zone from the urban landscape to a natural park. As mentioned, the detailed plan shows the area as a green stripe, so the proposal could strengthen this quality.

4

DESIGN PROCESS & USER PARTICIPATION

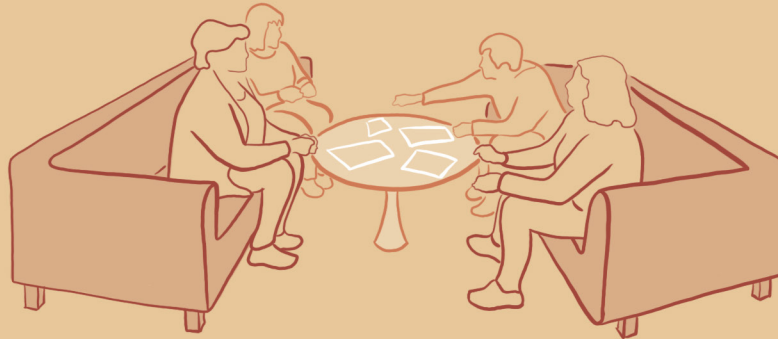

THE VISION AND THE PROGRAM

CONTACT WITH MÖTESPLATS ÅBY

Interactions during the times of a pandemic are difficult, posing additional challenges and requiring more time. Nonetheless, Mötesplats Åby has proven to be a very good choice for cooperation and offered a lot of help in reaching out to older adults. This also confirms that communities and their meeting centers are a very valuable stakeholder in health promotive projects - it is in their interest and power to make positive changes in their environment. I was invited to participate in a work group hybrid meeting (on site and online) during which I presented the project shortly, explaining what help I needed to be able to run workshops. The presentation led to a very interesting discussion about the topic and the group's current work with it. We came to a conclusion that, in fact, our goals are the same (helping older adults and elderly stay healthy and active) and we could continue exploring ideas together. This would happen through 2 participatory workshops with seniors (described later in this chapter) and, if possible, another internal workshop with people who could contribute to the initiative.

FORMING A VISION

Following the agreement about workshops and while researching the topic, I began thinking about an overall vision. Since it has been difficult to find very similar projects in Sweden, I came to a conclusion that it is important to use the existing facilities, networks and structures to introduce the new idea as an initiative that ties to a developed and strong background. It should give an impression of being new, but also familiar. Furthermore, flexibility should be one of the main design principles to allow for easy development and adjustments in the future, once the needs of older adults change. Therefore, these

3 words have become a guide for my overall vision:

new
familiar
flexible

Since community centers are quite popular in Sweden and their main purpose is to bring people from an area together, the new facility could, to some extent, become a part of one. As shown before in the Theory chapter, health promotion may often be included in those as one of the goals of activities for elderly. Therefore, my idea involves Mötesplats Åby as the main stakeholder who could use the new spaces to run and organize activities, help older adults and encourage interaction - doing all the things they are now, however on a bigger scale and with additional functions. The other side of the vision is a medical center that could provide professional support and knowledge. Here, this role could be fulfilled, for example, by the existing medical facilities nearby the site. This type of collaboration, as can be concluded from the Theory chapter, could contribute to the Swedish vision of health promotion.

The facility would be located in the park next to Åby Mötesplats which is a natural meeting point. It offers a lot of space, allowing for flexibility in terms of number of participants during potential events. In addition, a connection with the existing health path can be established, since the park is located in a corner where it turns around and continues into the center of Mölndal (see the map on pages 30, 31 in the Context chapter). The graphic on the next page shows the vision schematically.

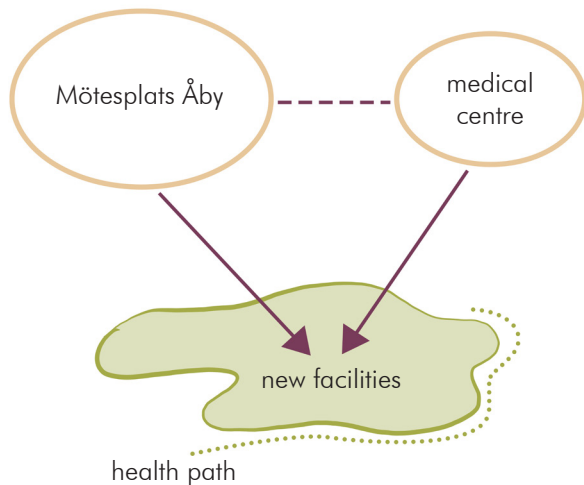

The vision schematically.

PARTICIPATORY WORKSHOP 1

While working on the vision, I arranged the first workshop with Mötesplats Åby. The aim was to understand the area from the participants' point of view and find out how they perceive a healthy lifestyle. The workshop was challenging due to several reasons: the language barrier (I do not speak Swedish well enough), the pandemic (the uncertainty) and the fact that this was the first time everyone was meeting after the restrictions were lifted. I decided it would be most comfortable for the older adults if everything was translated to Swedish. That meant that my ideas had to be very visual-based, meaning that the answers had to be written down or marked in some ways for me to be able to understand and draw conclusions. Therefore, I decided to use different materials and an A0 sheet with a map for everyone to work with.

The workshop consisted of 3 parts (see Appendix 1 for the full English version):

1. Using stickers of different colours to mark locations: home, favourite meeting points with friends, disliked and pleasant places.

2. Group task: discussing and writing down ways of looking after one's physical and mental health (on sticky notes). Afterwards, using stickers, marking the things they do regularly and the ones they find unpleasant.

3. Group task: a bit more creative part. First, choosing two locations for an event about health for elderly. Then, drawing a pleasant walking route and showing what is on the way using printed cards with icons.



Materials to be used for answers on the map and on the workshop sheets.

All the tasks were based on an extensive list of questions I have prepared to reflect on what I needed to know from the participants. Due to the time limitation (1,5 hours per workshop) I had to select and combine those together, resulting in the 3 efficient parts above. I also made instruction graphics for each task, which reduced the time spent on understanding which materials to use and how. Each participant got a sleeve with Swedish instructions and tools.

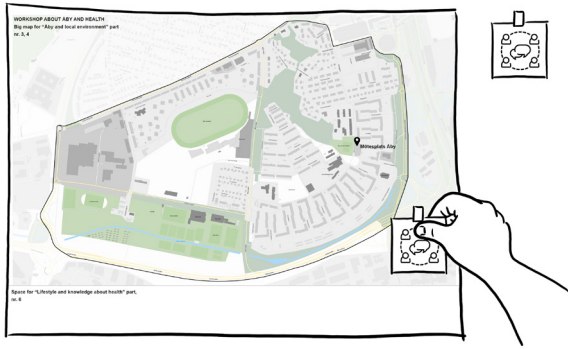

One of the instruction graphics pasted under each task in the workshop sheets.

WORKSHOP 1 - RESULTS

From my previous experience, it is important to be prepared for many potential changes, so I had a lot of backup materials with me and had flexibility in mind from the start. There were around 14 participants (some could not stay until

the end), so we decided to split into two groups, resulting in two maps. The older adults seemed very interested in discussing health problems and I received a lot of valuable input. Some tasks were followed in a more loose way - especially at the end. I believe it was a natural turn, as it became less formal and more about the discussion.

The graphic on the next page shows the results from part 1 and 3 combined on one map. The park extending from Mötesplats Åby towards the city center is visibly very popular among the participants. They talked about it in a very positive way, saying it is a very pleasant place to be in. One person dislikes the area right opposite to the meeting place - possibly due to the playing fields and a lot of concrete surface (this is an assumption). Mötesplats Åby was picked the most often as a good place for meeting friends. The majority of the participants pointed towards green places as their favourites.



4 participants from one of the groups working on part 2.

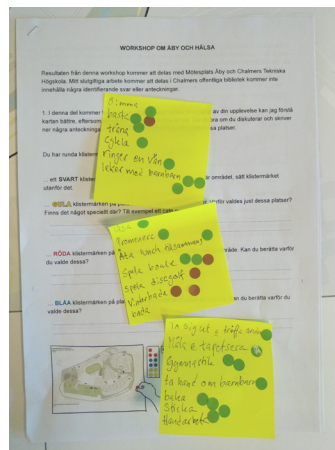

Results from one of the groups.



Summary of results from part 1 and 3. Map exported from Mölndalskartan (Mölndals Stad & Lantmäteriet, n.d.).

In part 2, the ways of taking care of one's own health included:

- Shopping healthy groceries in the popular Swedish stores (Coop, ICA and Lidl)
- Eating at healthy restaurants or other food places, having lunch together, baking
- Physical activities: swimming, workout, cycling, walking, playing boule game (disliked by 1), disc golf (disliked by 1), frisbee, gymnastics, billiard, home gym activities on TV, pool training (rheumatology)
- Winter swimming (disliked by 2)
- Playing and taking care of grandchildren
- Talking to friends, meeting others
- Reading
- Painting, needlework, knitting

WORKSHOP 1 - CONCLUSIONS

Overall, the workshop was successful, although I think the tasks should have been simpler - I consider this to be a good learning point for the next activity. The event was extremely helpful in understanding the target group better. Even though it was planned to be more about collection of information, the discussion also took creative turns, for example when someone mentioned it would be good to have indoor gym activities in Åby. The older adults gave an impression of being very interested in staying active and healthy, both physically and socially. Analyzing the results, it can be concluded that the site choice is good, since it will be exposed to a lot of people and could be connected to the existing facilities. It will be important to keep the natural atmosphere in the new project since nature was a theme repeated in many answers. The design should also include both group activities and more individual options for everyone to choose what level of socializing they would like. Of course, it must be noted that others in this age group, who did not join the workshop, might not be as open and eager to participate in health promotion, so variety and flexibility are essential. The activities listed in part 2 made it possible for me to prioritize functions in the building program.

DESIGN PROGRAM

While researching the topic, I started preparing a list of possible spaces that could be included in the design. Following the workshop I began to prioritize and select the ones that would be suitable for the target group. First of all, to encourage physical activity all year round and provide easy access to support, I decided to include a multifunctional gym (including equipment and space for exercise sessions). As mentioned before, older adults may need guidance and professional support to use the equipment in a correct way or in relation to their health conditions, so nearby there should be space for consultation and staff. In the same area or building health advice and health check-ups could be offered. The connection between these functions might allow for close cooperation of the staff (medical specialists, trainers, consultants) and allow for a more holistic approach to health promotion. The rooms could be used for multiple functions to ensure they do not remain unused for extended periods of time. Including restrooms in the design is also necessary, since there are no open toilets anywhere nearby, potentially causing inconvenience for the elderly visiting the park. Another important function to include is a flexible space for events. It should be located in a more open area to accommodate different numbers of people outdoors (for example during warm months or a pandemic). This space could also be used as a café, library corner or creative space where elderly can socialize while enjoying a break or their hobbies. The atmosphere there should encourage co-creation and involvement in the life of the facility. Finally, more resting spaces with seating are needed, the design of which should also encourage interaction. They could include for example games or be located right next to a specific function, such as the Boulebana.

On the next page the design program is shown in a scheme with connections.

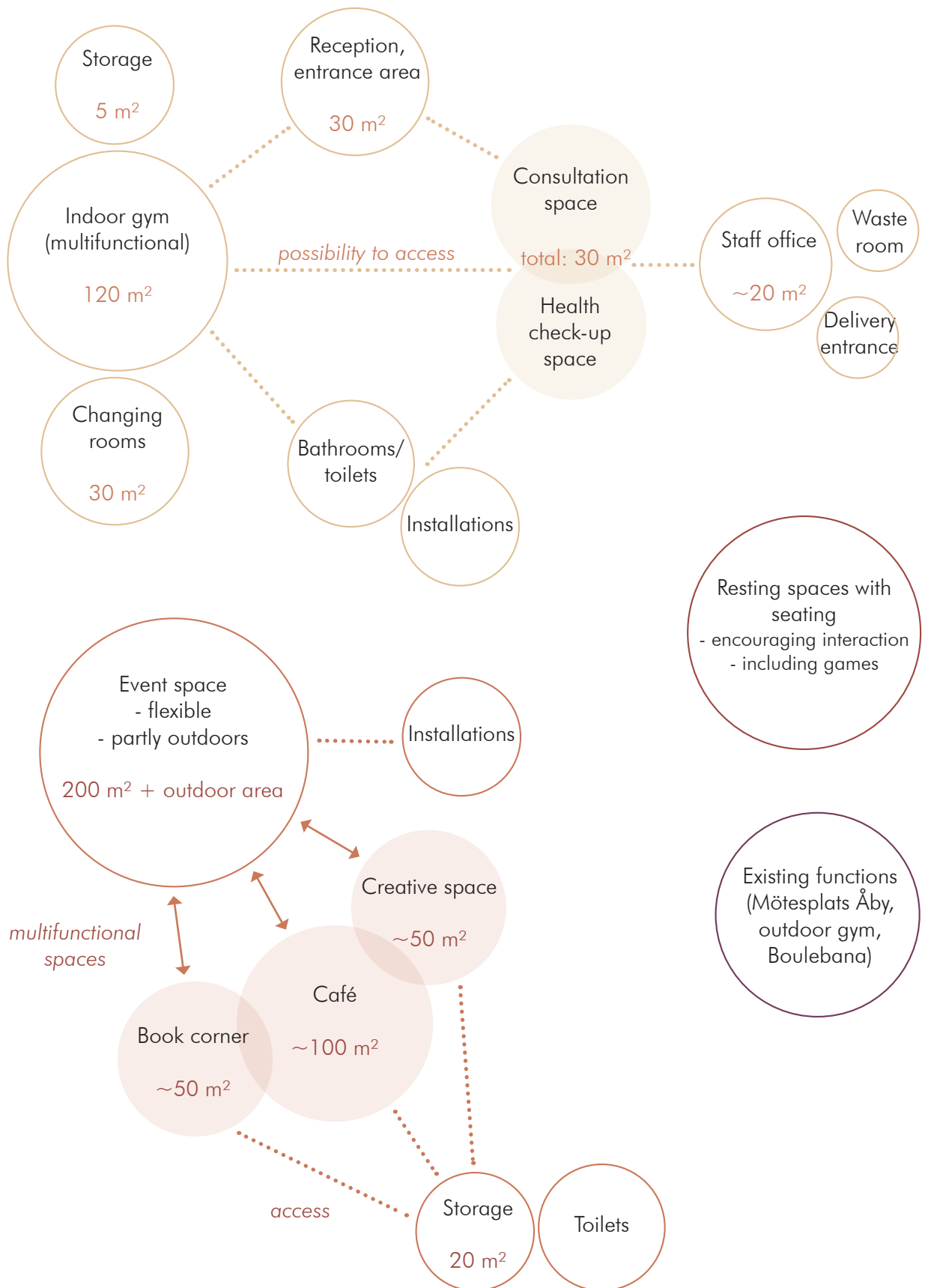

The design program divided into 4 areas and relations between different functions.

DESIGN CONCEPT

The vision explained earlier locates the facility in the park with Mötesplats Åby connected to it and the medical center providing professional support. It will also neighbour the health path, offering a variety of activities for the elderly walking on it. To keep the natural atmosphere, the built structures should fit in the landscape and remain close to the human scale. Therefore, I decided to split the new facility into multiple smaller points with different functions, dictated by the existing features to some extent. This way, the buildings will remain small and the park can be extended towards Mötesplats Åby, transforming the concrete surrounding. The new spaces should be tied and work

together, making it clear for a visitor that together they form a health promotive park for older adults, as shown on the sketch below.

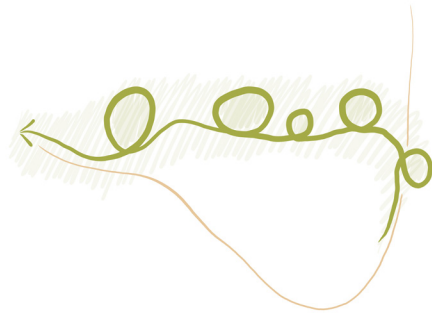

Sketch of the design concept: the new spaces are spread throughout the site and form "knots" that are tied and form one facility together.



The design concept.

FLEX PAVILION

This building is located right next to the natural part of the park - the slope with rocks and old trees. It can be used for organizing health events or simply events for older adults to meet each other and socialize or exercise together in the fresh air. There should be enough space left around the built part to be able to accommodate bigger, open-air activities. For use at other times, the Flex Pavilion will house a café serving healthy snacks, a small library corner and a creative space for arts and crafts. These spaces should be connected and encourage interaction among the users, resulting in a cozy and co-creative environment. This idea is to some extent inspired by Café Möllan in Mölndal - it can be visited by anyone but since it is a part of facilities created for elderly, it is mostly older adults who spend time there. It is an open space where they also hold activities while serving sandwiches and coffee (Mölndals Stad, 2022d).

FITNESS AND CARE PAVILION

This building will include spaces for exercise and professional care. The existing outdoor gym will relate to the design, complementing the indoor facilities. The building will include spaces for guidance and consultation with a specialist as well as rooms for health advice and check-ups. These spaces should also be flexible and possibly multi-purpose to ensure they do not remain unused for long periods of time. The building is situated near a road that can be used for deliveries, the same as for the Flex Pavilion.

GAZEBO

This structure is light and protected from bad weather conditions to some extent (depending on the target group's preference from the 2nd workshop). It will be around 2-3 times bigger than the existing gazebo which fits around 6 people. It may be used as a gathering or resting space as it is now. However, an additional function will be added that encourages interaction and brain exercise - games, which are incorporated in the tables, for example chess.

BOULEBANA

The game will remain in the new design since it is enjoyed by the older adults. However, the space will offer better seating options (suited for elderly) and become more defined with extra planting.

MÖTESPLATS ÅBY

The space is currently used by the work group and offers facilities for them to cooperate, have lunch, etc. It also includes a cozy indoor front space with sofas and tables, which are used for meetings and activities. However, the facility is not well connected to the park and does not stand out as a community center. This will be changed by improving the area in front of the facility and tying it to the rest of the spaces in the park.

DESIGN QUALITIES

Following the vision and the design concept, I began sketching possible buildings and defining the desired atmosphere of each of them. Therefore, the second participatory workshop was focused on this topic and aimed to be creative.

PARTICIPATORY WORKSHOP 2

The next workshop's aim was to introduce the design vision and concept, and receive feedback on them, as well as create an idea of the atmosphere and building features desired by the older adults in the context of the future facilities. Having learned from the first workshop, I decided to make this one simpler and include more time for breaks and discussions. The meeting started with a presentation of results from the previous workshop, introduction of the site, vision, design concept and a reference project - a pavilion in Kungälv. I prepared beforehand to be able to explain as much as possible in Swedish and, with the help of Mikael and Margareta from Mötesplats Åby, the workshop began with a valuable discussion about the project. This was followed by 2 creative parts:

1. A warm-up task: selecting a preferred option out of two representing different building atmospheres, features or characteristics based on my process until this moment - the design and the context analysis and some of the theory. Each participant received sheets with 12 pairs and was asked to make a choice in each of them. Every option was accompanied by a picture used as a clarification, but it was stated that the idea is to think more in terms of the desired atmosphere (or qualities) and not specific design solutions. The 12 pairs included the following building qualities:

transparent and light - more private

(building in its context) stands out - blends in



Sheets with 12 pairs of different building qualities for part 1.

concrete - wood (on the walls)

stones - wood (on the floors)

arranged surrounding - natural surrounding

view of nature through the roof - roof access
with view

enclosed - open (interior spaces)

very green interior (like a garden) - less green
interior (like a house)

warm - cold

pastel colours - strong colours

neutral colours - contrasting colours

light - dark

2. Creating a moodboard for the design of the Flex Pavilion, the Fitness and Care Pavilion, and the gazebo. The participants were split in 3 groups of 2-3 people and asked to work together using the provided materials: a variety of pictures of buildings, interiors, design ideas, colour palettes and materials, printed words, post-it stickers, pens, scissors, and glue. Each group received an A2 poster with the building names and their functions printed on top, making their work easier and consistent. They were asked to take their time and discuss their ideas, think of the existing context and location of the building. Here it was also stated that it is more about the atmosphere and less about the specific solutions shown in the pictures, however it is valuable to tell me if they really like something specific.

WORKSHOP 2 - RESULTS

This time, there were 8 older adults participating, most of which also took part in the first workshop. Before the meeting, they had a workout session

which they enjoyed a lot - they were exercising with energetic music. After a short break, we started with the presentation. Looking at the results from the previous workshop started the discussion and was appreciated as an explanation of the site choice and the design concept. The idea was met with very positive feedback and a lot of curious questions regarding the possible effects of such a facility and specific activities that could be organized there. The participants were intrigued with the added professional care part as well, since it is a new idea in Sweden to not make it a part of primary or hospital care. We discussed the project in England as a reference that has been successful. The response to the spatial qualities (splitting the complex into several buildings in the park) was also very positive, and led to a suggestion to place another building even further in nature - on the hill. However, due to the natural environment, it would likely be difficult to obtain a permit for that. If the facilities were built and proven successful, in the next stages it could be possible to place, for example, an open and light gazebo there.



Participants working on part 2 at Mötesplats Åby.

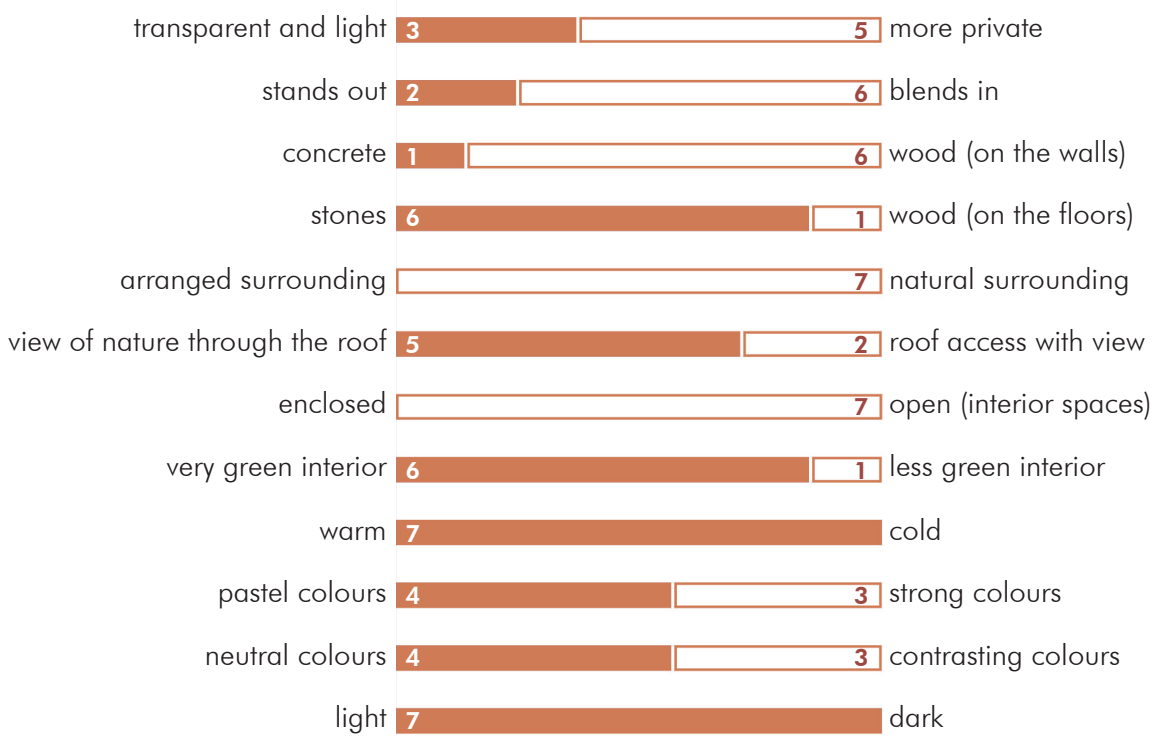

Results of part 1 with number of answers given to each option. One person answered only in the first two pairs, hence the difference in the total numbers.

The first task was met with a lot of enthusiasm and interest, but also a very good understanding of the desired focus on atmosphere and more general design qualities specific for the context. As can be seen in the diagram above, most participants preferred privacy over transparency and light. However, many had mentioned that they would like something in between, to have both. Majority of them thought that the buildings should blend in with nature rather than stand out, since it is a very green area. As expected, most chose wood as a facade material over concrete which usually results in a rather cold and rough atmosphere. However, wood was not the preferred option for the outdoor ground material. This is consistent with the desire for the building to blend in as I concluded from a discussion during which I was told that the natural surrounding means that the ground outside should rather be covered with stones. Similarly, everyone chose a natural surrounding over an arranged one.

In addition to that, the participants liked the idea of being able to see nature through the roof of the building - more than being able to access the rooftop and see the view from there. This choice, as well as a strong preference of a green interior, started a discussion about biophilic design which was not known to them as a design concept. They showed great interest in it and began comparing it to the older buildings where cleanliness and a kind of sterile environment were more common. The idea of keeping nature as close as possible seemed very exciting and more pleasant. Everyone also preferred if the spaces are open, rather than enclosed. Warmth and light were chosen unanimously over cold and dark. The biggest differences between the participants could be seen in the two pairs focused on colours. While the majority of older adults liked pastel and neutral colours more, almost half of them preferred strong and contrasting colours.



Results of the 2nd part from two groups.



Results of the 2nd part from the third group.

The 2nd part, creating an inspiration board, was creative and took a long time due to interesting discussions. The participants were all very involved and enthusiastic, providing me with extremely valuable input for the rest of the design process. All the visual results are shown in the pictures on the left and above.

The Flex Pavilion was portrayed as a warm, green and light building, with wood being the main material and cheerful (but not various) colours inside. Here, attention was also given to having close contact with nature - both visual and close. All 3 groups used the picture of a sofa and a coffee table, seeing it as soft and cosy.

The Fitness and Care Pavilion had more of a clean appearance on the moodboards. Greenery was shown there too, however in a more organized

manner, less biophilic or natural. This building was seen as a more professional or formal type of space, where the focus is on its functions, allowing for easy and comfortable use. The participants mentioned that they would like to have both big rooms, such as a gym, and small ones for more personal activities, for example consultations with specialists.

The Gazebo's intended function was met with support and interest, so the participants chose many pictures depicting games or other social activities. They would like the space to remain very open and light, but, at the same time, protected from the bad weather conditions which are common in this context. For example, making the facade glazed would allow for the space to be used comfortably during winter.

WORKSHOP 2 - CONCLUSIONS

Receiving positive feedback on the concept and design ideas allowed me to continue developing the project in the set direction. The answers given in both tasks have provided me with a good understanding of the target group's preferences of atmosphere and spatial qualities.

First of all, the participants view the atmosphere in relation to the assigned function of the buildings - they saw it as a way to express what the spaces are used for and enhance this practical quality. This would make it clear for the users what the building's purpose is and whether it is a place for relaxation, activity or meeting with a health professional. Ensuring that the functions inside are immediately clear based on how the space is perceived may support orientation within space (the park complex in this case) among older adults which is of great importance for those who begin to struggle with cognitive disorders. Therefore, following the preference of the participants, the Flex Pavilion should be a positive, warm and cozy space, while the Fitness and Care Pavilion could be more functional and clean, allowing for easy use. Similarly, the gazebo should be a light and inviting structure, where everyone interacts with each other by playing games or simply relaxing.

Secondly, all the answers and ideas during the workshop were consistent with staying close to nature. Designing the buildings to blend in their surroundings would make the park more welcoming and pleasant to spend time in. The materials as well as the colours preferred by the participants follow the same concept, both inside and outside. The interest in biophilic design and green interior spaces was very high among many older adults, as it was a rather new and exciting idea. The buildings should therefore allow for very easy contact with nature, both the existing one and the new, interior one. This could be achieved, for example, by incorporating the idea

of a roof window opening up the view of the trees that was met with a lot of enthusiasm. This design feature could work very well on this specific site due to the slope and tall trees.

Finally, the workshop was valuable in deciding which design details to choose and to focus on. The designs prepared on the moodboards by the participants provided inspiration for the rest of the process and became a basis for further steps. Choosing wood as the main material not only connects the architecture to nature, but also ensures a calm and warm atmosphere - which can also be strengthened with the use of natural and pastel colours with stronger accents. Using both a lot of glass and creating more enclosed facades allows for creation of different levels of privacy while keeping the spaces light and inviting. A variety of sitting options may also cater to different needs and make the complex more welcoming. Outside, natural materials, such as stones, and a rather less arranged greenery could enhance the character of the park. Analysing the results of the workshop improved my understanding of the target group more, allowing me to make informed decisions and test the ideas. The co-creative part in task 2 was a very rewarding time during which everyone contributed with valuable input.

SHAPE AND FORM

INSPIRATION FROM NATURE

Using nature as inspiration for the form of the buildings aims to strengthen the connection with the natural surroundings and, in a way, make the project blend in as discussed during the workshops with older adults. The site has many qualities that could be used for this purpose, namely the hill or the slope, the trees, the organic shape of the park or the more geometric and rough shapes of the rocks forming the hill.

Having analysed the shapes of a variety of natural elements as shown on the graphics, I decided to continue developing the new pavilions with rocks as an inspiration. These are exposed in multiple locations on the hills, adding texture and defining the landscape. Using their geometrical, rather than organic, shapes and varied sizes will set the buildings in their specific context - they will be scattered around similarly to the natural formations. Furthermore, the pitched roofs and lower height shown on the next page will tie to the surrounding architecture which is also defined by those qualities.

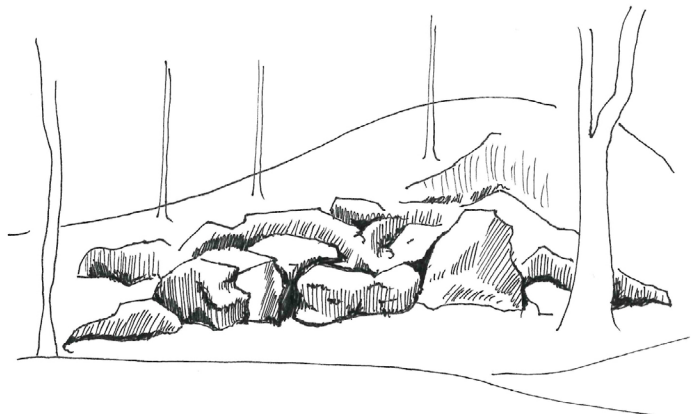
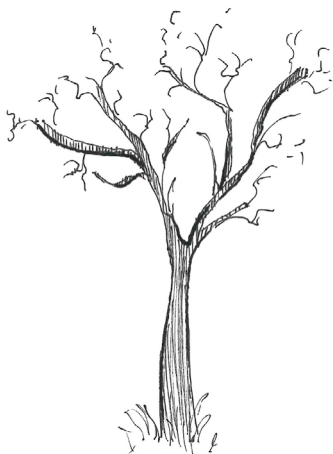
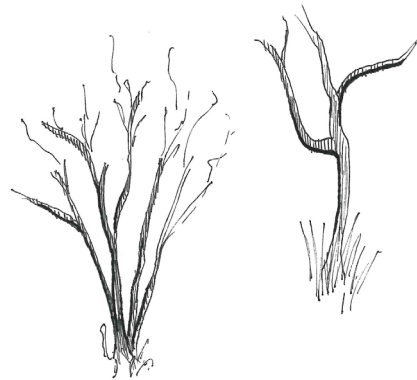
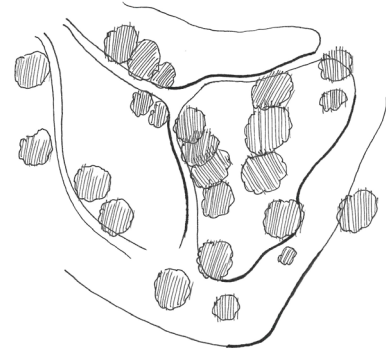

Natural qualities of the site: the organic shape, a variety of trees, hills, geometric and defined shapes of the rocks scattered throughout the park.

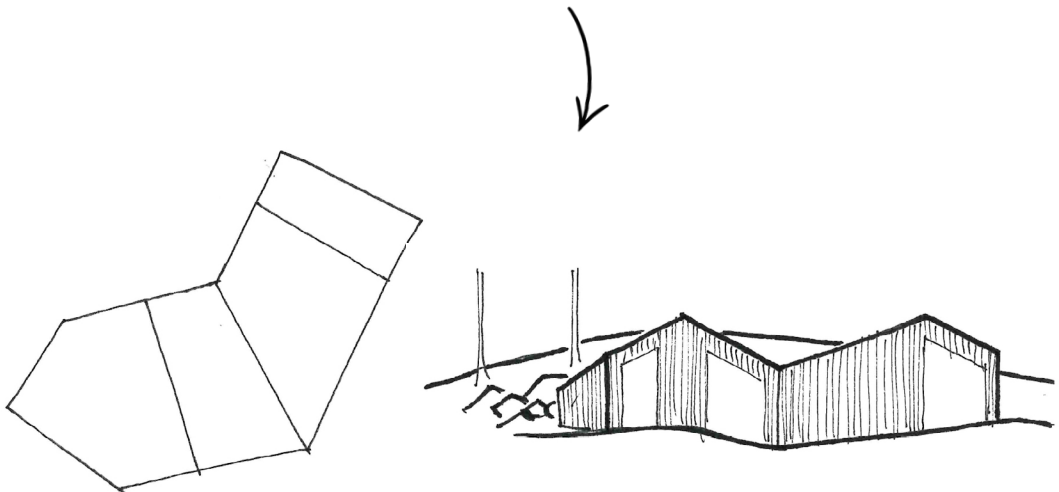
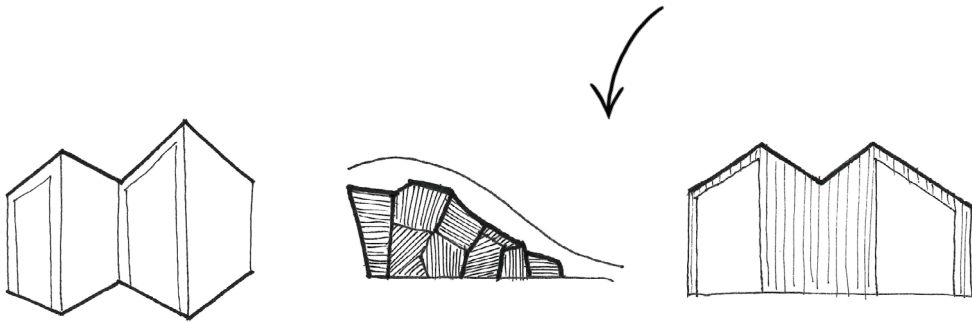
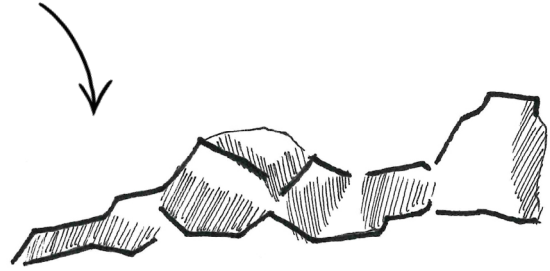
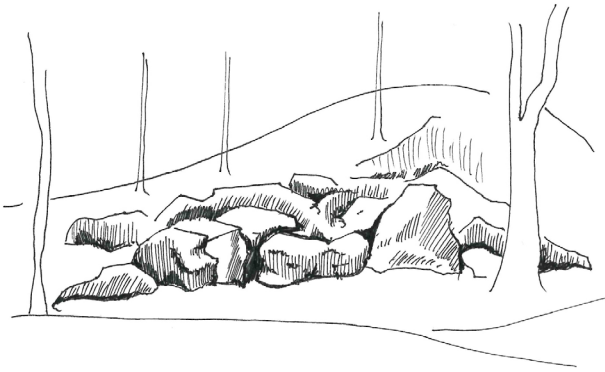

Using rocks as inspiration for the buildings' form and shape: sketching and simplifying, a step before adjusting to the site and functions inside.

SHAPING THE BUILDINGS

The following graphics show how the buildings' shapes were created. With the existing path lines, directions and terrain shape serving as the point of departure, I defined the areas which would fit the new structures. This way the buildings would have more of a geometrical form adjusted to the context, similar to the inspirational rocks. It was also of great importance to keep all the existing trees to leave nature as undisturbed as possible.

The first adjustments concerned the functions and the required floor space. First of all, the Flex Pavilion should have plenty of open space to be used as a sitting terrace for the café and as an outdoor event area. This is located on the South side in order to receive as much sun as possible. The building could also be made smaller to fit

the previously defined functions. This applied to the Fitness and Care Pavilion as well, where the western side was moved further away from the trees, and the Gazebo which was placed slightly higher than the existing one.

Ensuring that views of the hill and the park are still equally present was of significance as well, affecting the final placement of the buildings and their facades' orientation. This can also be seen in the first picture below, where the sightline of the hill from the street is shown, and the view of the hill trees from the Gazebo is marked. The next picture shows the adjustments made, as well as two additional changes: another sightline and extension of the Fitness and Care Pavilion to strengthen the connection between the indoor and outdoor gyms.

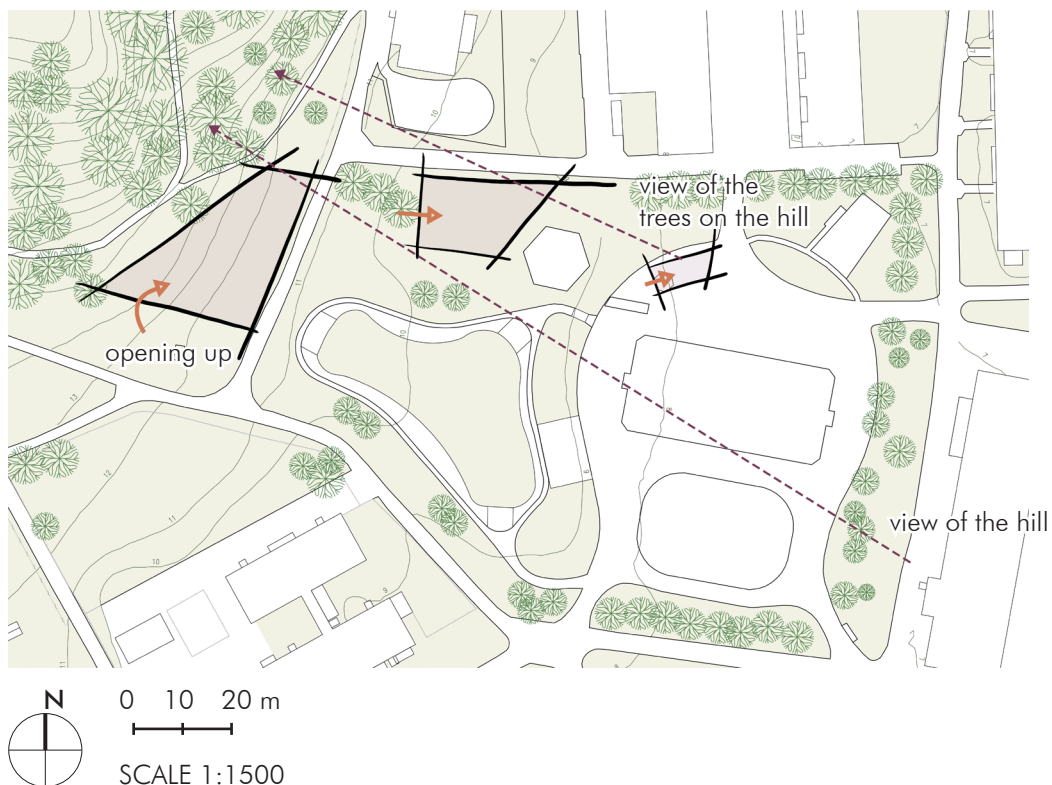

The first sketch defining the areas where the buildings would be located and their initial shapes. The arrows portay the first adjustments, the effects of which can be seen on the next page.

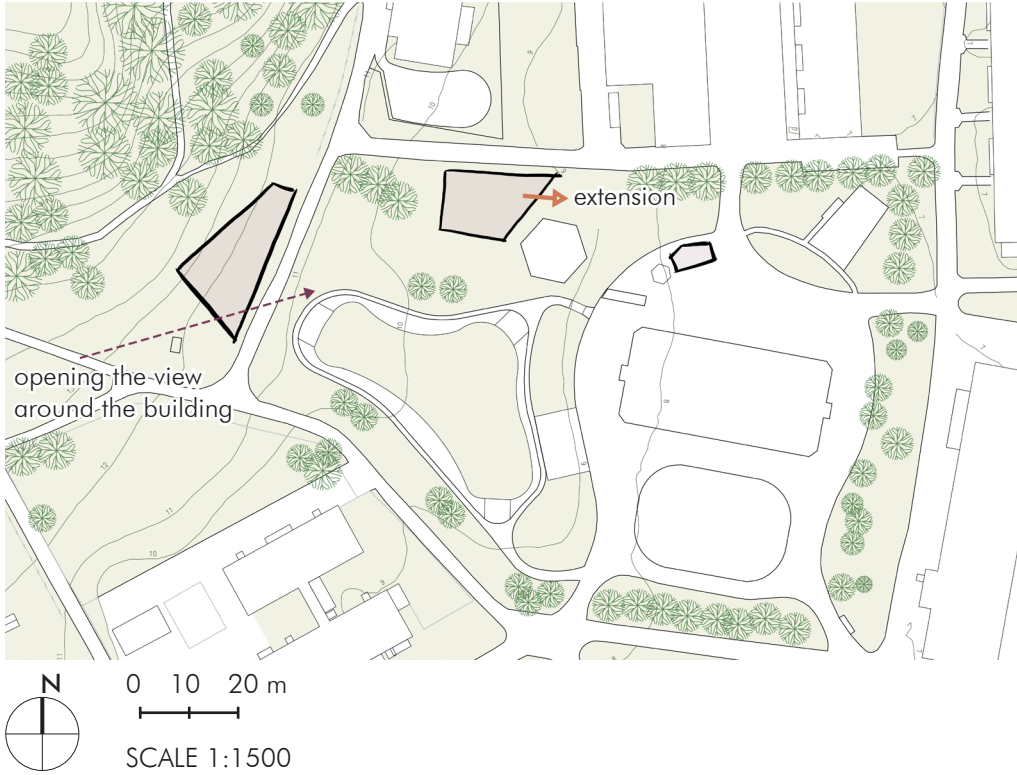

The buildings' shapes after the first adjustments.

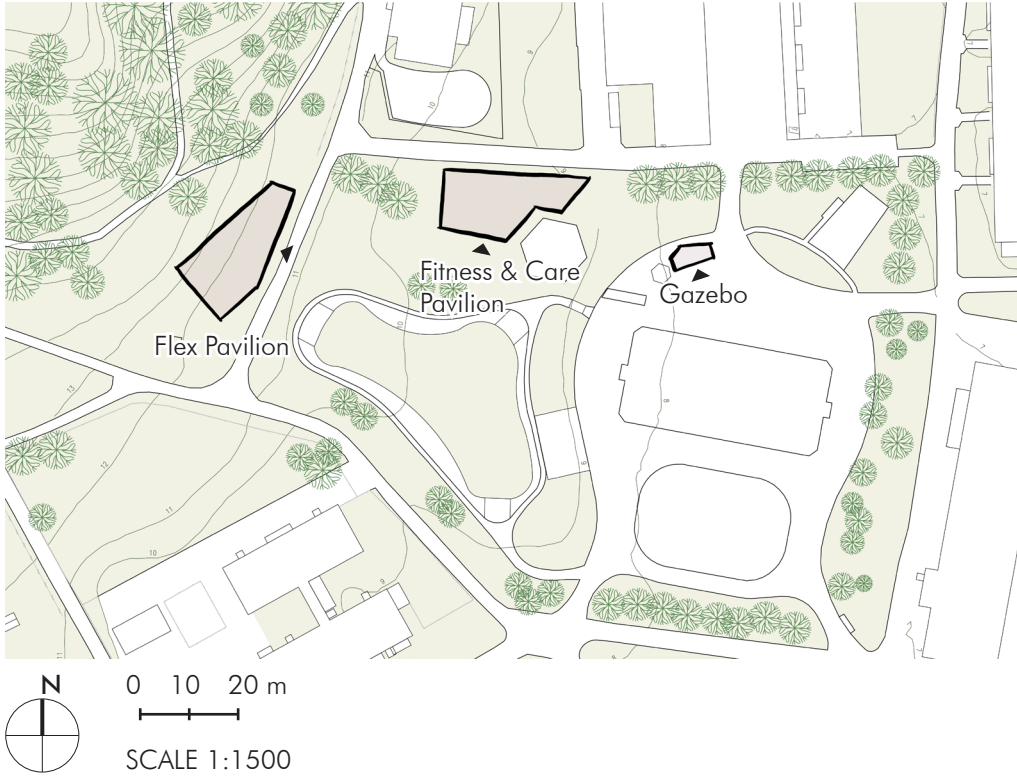

The final shapes of the new buildings.

SHAPING THE SURROUNDING

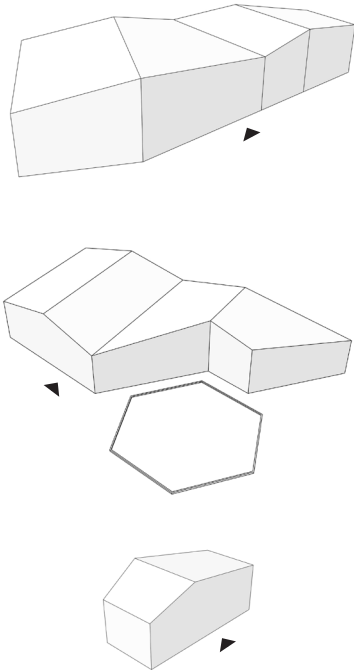

Volume models of the new buildings. Top to bottom: Flex Pavilion, Fitness and Care Pavilion, Gazebo.

Following the concept, I planned to transform the surroundings of the buildings to connect them and strengthen the idea of them working together as a whole. The new paths facilitate better access and flow, encouraging the visitors to walk up on the hill, subtly promoting physical health. These will also include stairs where the height difference is significant, making for a more varied landscape and contributing to healthier movement. There will be two new bike parking areas to encourage cycling from home to the new complex. As there are not many benches at the moment, there will be new seating to offer comfort to the older adults and strengthen interaction among the visitors. Furthermore, the area in front of Mötesplats Åby (possibly including the facade) should be changed to become a part of the complex and attract more people to participate in the community life.

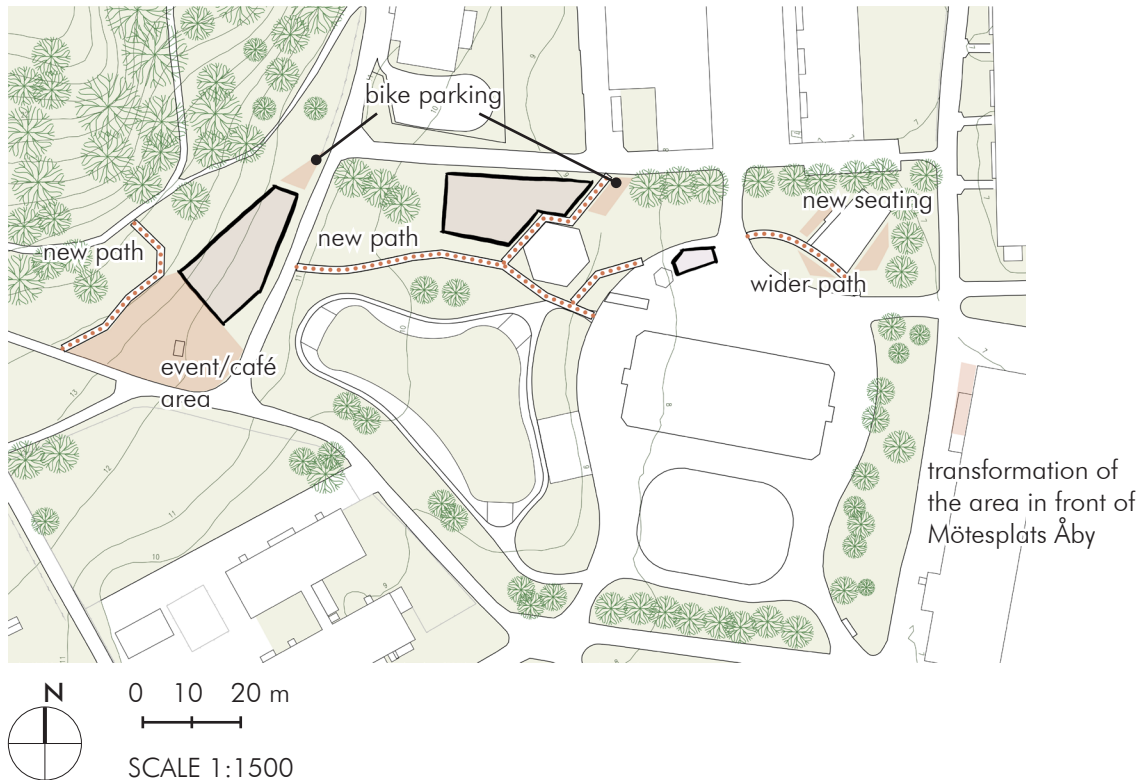

Sketch plan for transformation of the site following the concept.

5

DESIGN PROPOSAL

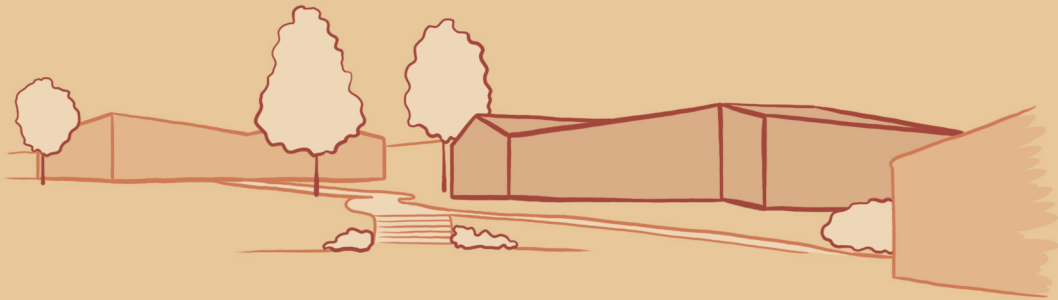

THE SITE



The design concept.

The buildings and transformed spaces follow the idea introduced before in the concept and tie together as one complex located in the park. This effect is achieved with their design as well as the surroundings. The site plan on the next pages shows an overview of the transformation. There is a new path connecting all the facilities together, improving access and encouraging more activity (walking) among the visitors. Rather than running along the obstacle course in the middle (as is the case now) it separates it to ensure safety and prevent collisions. The height difference on the western side is used to create a new shortcut leading onto the hill with stairs running along

a natural rock wall - an attractive element motivating to add a bit of healthy exercise to a walk.

New greenery aims to strengthen the atmosphere of a park while introducing extra qualities, such as useful shadowing or more privacy - these will be shown in more detail further on. The school facilities and playing fields remain undisturbed to allow for easy use. The new gazebo is located slightly further away from the jumping track for more safety, while the additional ramp leading to the new path may be used instead of stairs when the track is in use.



The site plan.

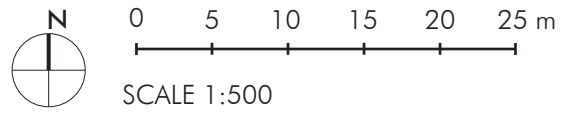



View from the school sports field towards the slope.



Top view of the roofs showing direction of the slope on the new buildings.

ROOFS

All the new buildings have slanted roofs, as explained earlier. The map shown on the previous page shows the direction of the slopes. The neighboring buildings also have pitched and slanted roofs, making the design fit in its surrounding.

Both the pavilions' and the gazebo's roofs are green, making the view both from the slope and from the streets around more pleasant and natural. The vegetation layer is low in order to keep the structure thin and ensure the buildings continue to look "light".

ACCESS

As shown in the Analysis chapter it is possible to arrive in the area by car or public transport (bus).

However, being a park, the site is a car free zone and this quality is kept in the design. The visitors can reach the buildings using the walking paths which extend in all directions. Every place in the park can be accessed with a wheelchair or with walking aids. In addition, next to the pavilions there are bike parking areas to encourage use of bikes as the transport mode. The cycling path running along the building where Mötessplats Åby is located is well connected to a street in the North of the pavilions, allowing for safe and fast access, for example when coming to the gym.

The delivery entrances in the Flex Pavilion and the Fitness and Care Pavilion are located near the western corner of the site, which is the shortest distance away from a road. This way supplies for the café as well as the care facility or gym may be delivered.

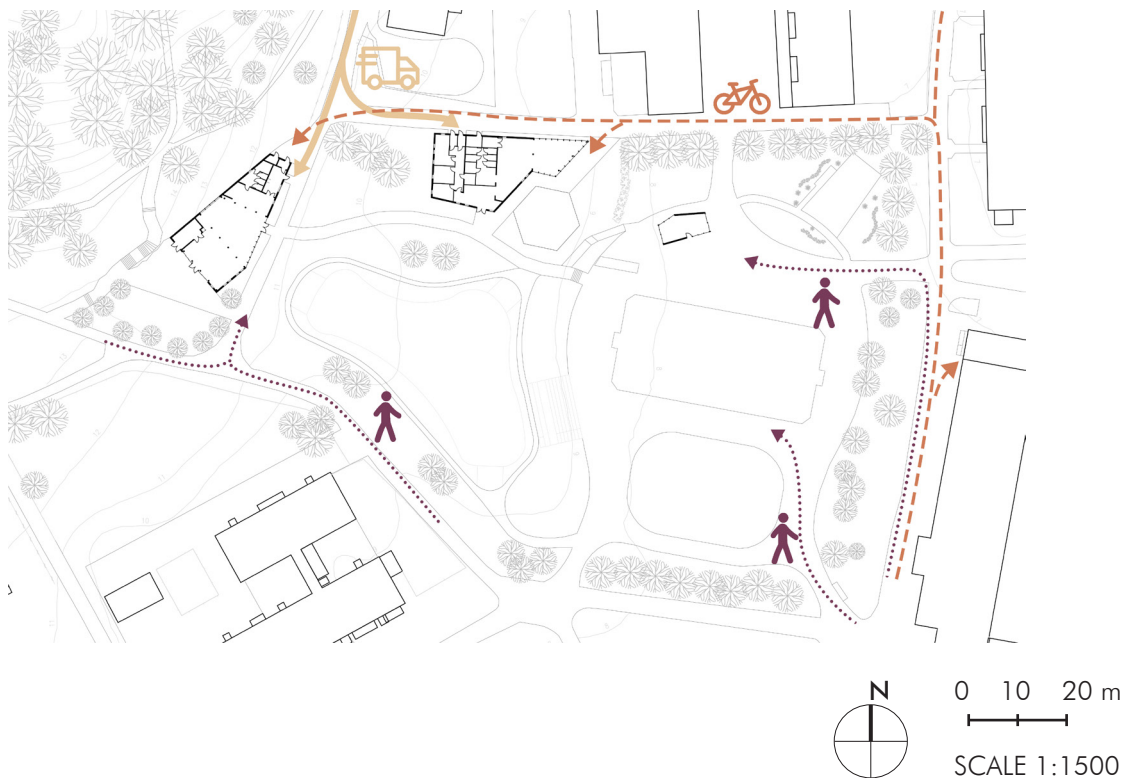

Access to the buildings for the visitors and for deliveries to the Flex Pavilion and Fitness and Care Pavilion.

BUILDINGS

FLEX PAVILION

The pavilion is an open space which includes a café with library (or book exchange shelves) and an arts & crafts corner. It's a building with a creative and calm atmosphere enhanced with the use of biophilic design - a clear connection to nature outside and plenty of plants inside respond to the target group's interest in this style. The pavilion's main purpose is to offer a space for social interaction and events, while giving opportunity to develop hobbies, such as reading,

knitting or organizing activities. The café's offer should serve as an example of a healthy diet and inspire the visitors. On a standard day, the building offers different levels of privacy inside, and on an event-day the furniture can be rearranged or moved to the storage to make space for the participants. In the warmer months, the Southern facade can be partly opened up, extending the café outside. The terrace is divided into an area with a surface made of natural stones and a grass field shadowed by the trees - which may be used, for example, for exercise sessions in the fresh air.

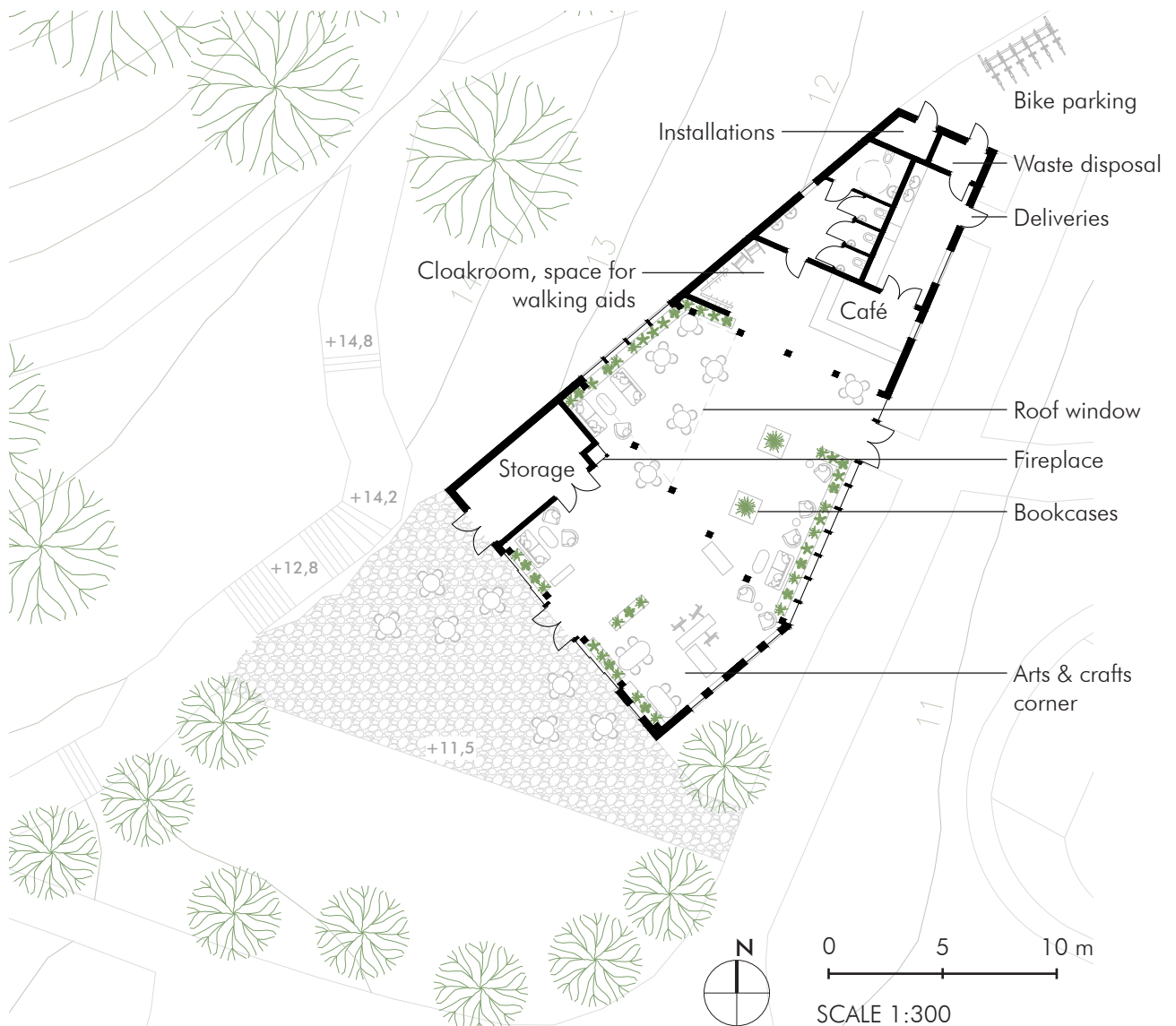

Flex Pavilion: ground floor plan.

During the workshops, the idea of a view of nature through the roof emerged and was very well received. The location of the Flex Pavilion with the hill in the back gives an opportunity to include a similar quality - view of the beautiful nature, rocks and old trees. The section below shows a glass corner of the building directed towards the slope, with the roof tilted slightly to the back. This feature makes the experience unique and calming for the visitors of the café.

The pavilion has a cosy interior with neutral colours and warm accents. In a corner, there is a fireplace visible from most locations inside the open area, which aims to be an additional quality especially for the darker and cold months.



Flex Pavilion: view towards the hill inside the café.



Flex Pavilion: section AA'.

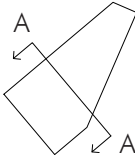

0 1 2 m

SCALE 1:100

In both pavilions glue laminated timber is used to span large distances and most of the structure is kept exposed, becoming a part of interior design. The facades, as shown below, are minimalistic and clad with light wood. The windows are

located in positions where light is needed inside but also in such a way that those who walk along the building can look into it and become interested to enter - for example by seeing how the café prepares food.



0 5 10 m

SCALE 1:300

Flex Pavilion: eastern (top) and western (bottom) facades.

FITNESS AND CARE PAVILION

The second pavilion is divided into two spheres that are joined with a reception and entrance area. The floor plan on the next page shows that the left side is designed for consultations and health check-ups with doctors (for example physiotherapist or geriatrician). It includes two rooms for appointments and one office with a kitchenette. The facility is small as this idea is new

in Sweden and introduced slowly in the project as a part of a larger complex. It is also important to ensure that the use of space is sustainable - the consultation rooms should not remain unused for extended periods of time, but rather used flexibly by different specialists. The healthcare centre nearby offers potential for cooperation and could become involved in the new facility.

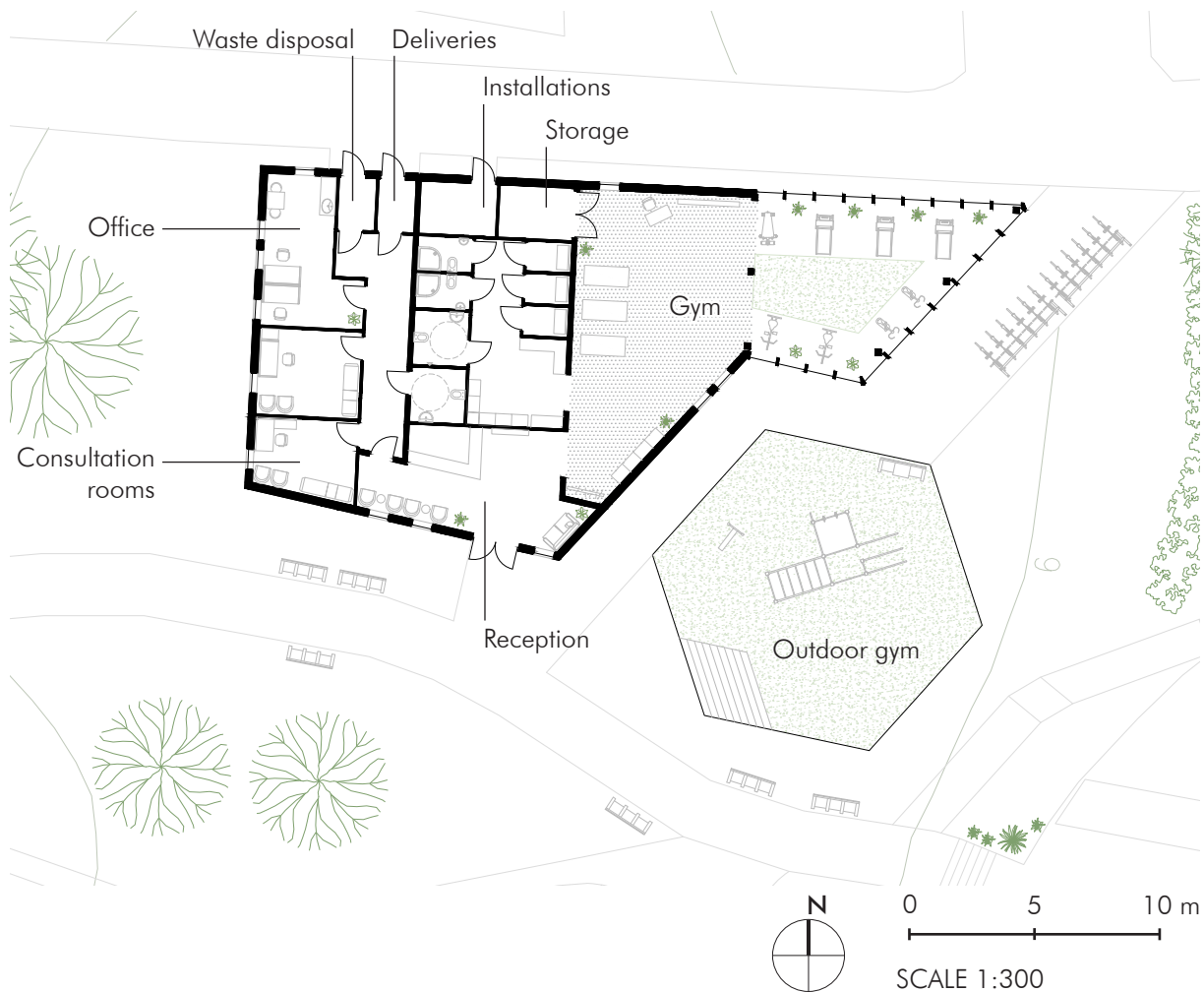

Fitness and Care Pavilion: ground floor plan.

The opposite side of the pavilion is a gym that includes changing rooms, a more private (with less windows) area for exercise and a glazed space with equipment. The latter one is green and has an atmosphere of a garden, similar to the Flex Pavilion. This way it also ties more to the outdoor gym, which becomes a part of the facilities, offering variety for the users. Inside, next to the entrance to the storage, there is space for a desk and presentation board that could be used during events or exercise sessions.

The two parts of the pavilion can be accessed through the entrance area, which includes waiting spaces, a reception and space for display of educational materials or information about activities.



Fitness and Care Pavilion: glazed part of the gym.



Fitness and Care Pavilion: section BB'.

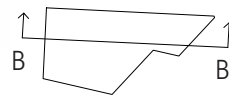

0 2 4 m
SCALE 1:200

As shown in the section, the rooms in the Fitness and Care Pavilion are spacious and have sloped ceilings with wooden structure, exposed in the gym. An exception to that are the small rooms, such as the bathrooms or changing rooms which have lower, suspended ceilings. This way, these spaces remain closer to the human scale, while the empty area above can be used for ventilation.

The material used for the facades is the same as for the Flex Pavilion and the Gazebo, with the glazed part of the gym exposing the function of the building and facilitating orientation - a quality important in health promotive design for older adults.



0 5 10 m

SCALE 1:300

Fitness and Care Pavilion: southern (top) and northern (bottom) facades.

GAZEBO

The new gazebo is larger than the existing one and weather-protected. Its function remains similar, however its design is more suited to the target group. The building can be used as a gathering or resting place nearby Mötesplats Åby, but its added quality is games that encourage interaction and brain exercise. These are incorporated into some of the tables, as shown in the picture below, and additional elements may be stored in the cabinets inside the gazebo or at Mötesplats Åby.

Two walls of the building are closed and clad with the same wood as the pavilions, while the rest is made of glass and creates two light corners inside. The West and East facades include sliding doors which can be opened during the summer to ensure good temperature and air flow.



Games incorporated in a table. Photograph by BLACK + DECKER (n.d.).

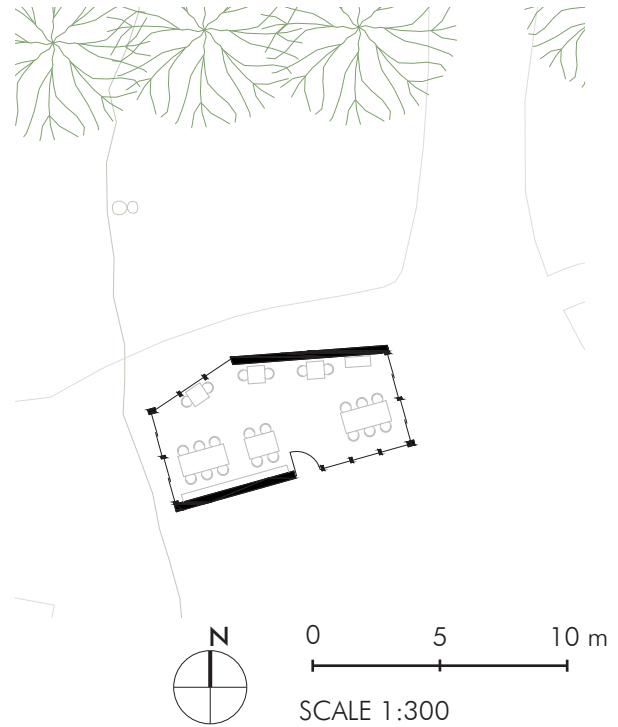

Gazebo: ground floor plan.

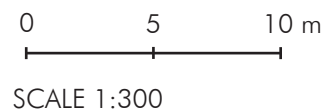
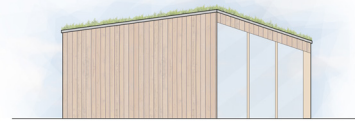

Gazebo: northern (top) and southern (bottom) facades.

MÖTESPLATS ÅBY

Since Mötesplats Åby already serves as a location for staff, meetings and small events, its function remains the same. It is a good place from which activities in the new Health Park could be coordinated. However, as concluded during the workshops, it does not attract enough people to come in or participate in the facility's life. While a lot is done to try to promote Mötesplats Åby, including different channels of communication, the meeting center does not stand out physically. It takes up only a very small part of the entire building, as shown in the picture below, and does not have an attractive front area. Therefore, I decided to focus on improving its outdoor aesthetics. The transformation is rather simple as the facility should remain to be a part of the whole.

As shown on the next page, the existing ramp is replaced with a new one that continues past the doors as a platform where an ergonomic bench with table is located (explained in the next section). It may be used by the staff during a break or by visitors. The railing is made using the same wood as the facades of the new buildings to form a connection between different facilities. There is a step added in the middle to be able to

access the door directly (without using the ramp) and for the entrance to stand out. On the sides there are new plants that make the area look more lively and connect to the park. In the very front, I placed a wooden information board facing both sides of the walking and cycling path. This way, information about events is noticed by more residents. Finally, to add a more public character to the meeting center, I added a small awning above the windows.

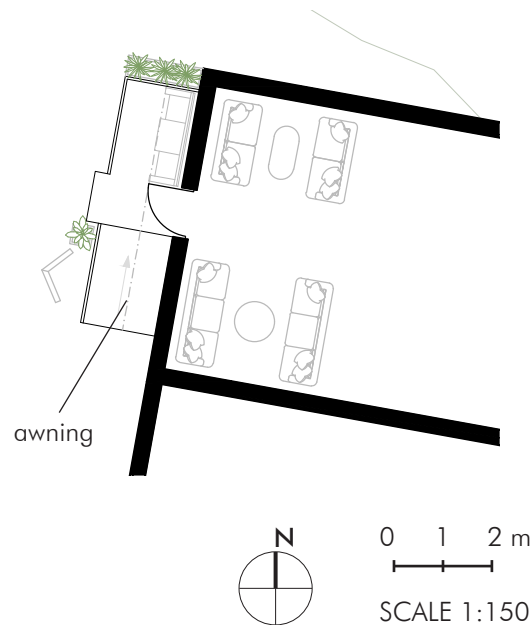

Mötesplats Åby: front part of the space - ground floor plan.



Front facade of the building where Mötesplats Åby is located. The frame shows the exact location of the facility.



Mötesplats Åby: facade before (left) and after the transformation (right).

DETAILING

As explained in the Theory chapter, in health promotive design for older adults it is essential to consider all scales, including small details that may differ from the standard ones. Two examples developed in this thesis are seating and stairs. Both contribute to the level of comfort during two different equally important activities - resting and walking, and may affect users' physical condition, for instance posture or fitness.

SEATING

Comfortable and well-designed seating may offer many benefits to the target group. Improved posture and good support reduces pain and the risk of acquiring health issues, such as pressure

ulcers (Blackler et al., 2018). Since the project is a complex of buildings connected to the outdoor area and facilities, I decided to design benches that could bind the area together even more and offer plenty of comfortable resting zones.

The first parameter to consider is seat height, being also the one that varies depending on the desired purpose (sitting comfortably for a long time or being able to stand up easily) and body size as explained in an article by Blackler et al. (2018). The authors clarify that seat height will determine whether more pressure is located on the pelvis or along the thighs (desired option) and suggest that offering various heights is a good solution. This parameter is dependent on the popliteal height of a user (lower leg length). While the



Swedish standard seating height is between 450 to 500 mm (National Board of Housing, Building and Planning, 2004), it does not respond to everyone's needs. The popliteal heights of Swedish adult women lie between 385-524 mm ($M=447$ mm), and men's between 415-571 mm ($M=486$ mm), based on studies of working-age groups (Hanson et al., 2009). Therefore, to offer variety the benches will have 3 different heights: 400 (1), 470 (2) and 540 (3) mm. The middle dimension is a standard seating height, while the other two may offer a more comfortable option for those who are shorter or taller.

The next parameters are seat depth and width. Blackler et al. (2018) suggest that reduced depth (even if the seat is high) may be a solution to cater to more users as there should be enough space behind the knees for good circulation. The popliteal lengths (for seating depth) of Swedish adult women lie between 296-572 mm ($M=478$ mm), and men's between 406-567 mm ($M=496$ mm) (Hanson et al., 2009). However, as can be concluded from the tables provided by the authors the lower values are statistically very rare, and 5th percentile female has a 431 mm long popliteal length, while 5th percentile male has 451 mm. The values used for the benches are: 330 (1), 400 (2) and 470 (3) mm to leave enough space behind the knees, considering the fact that older adults' posture may be smaller than working-age adults'. Seat width is less critical and Blackler et al. (2018) use an example where hip breadth of a 95th percentile woman was used as a value. In Sweden, this equals 463 mm (Hanson et al., 2009). The bench's seat width is 470 mm.

Blackler et al. (2018) also mention the importance of armrests that help a user stand up more easily and keep the balance. These should have a height of 250 mm from the seat, width of 120 mm and an extension of 120 mm from the front of the seat.

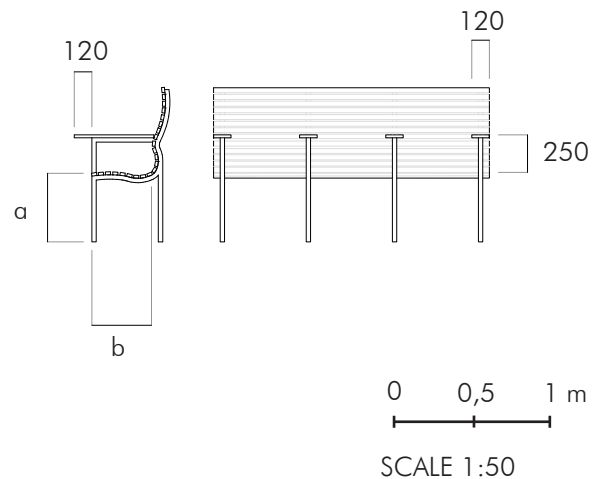
The space under the seat should be open to allow the user to move their leg underneath while standing up (Center of Design for an Aging Society, n.d.). Back rest is also an important feature that may influence comfort and correct the position. It should have a contour of the spinal curve with the seat slightly tilted to the back to ensure the user does not slide forward (Nitz, 2000).



	small bench	medium bench	large bench
a	400	470	540
b	330	400	470
frame colour			

Dimensions of 3 types of benches (side and front view, in mm). Each type is colour-coded for clarity, so that users can easily find the one that fits them.

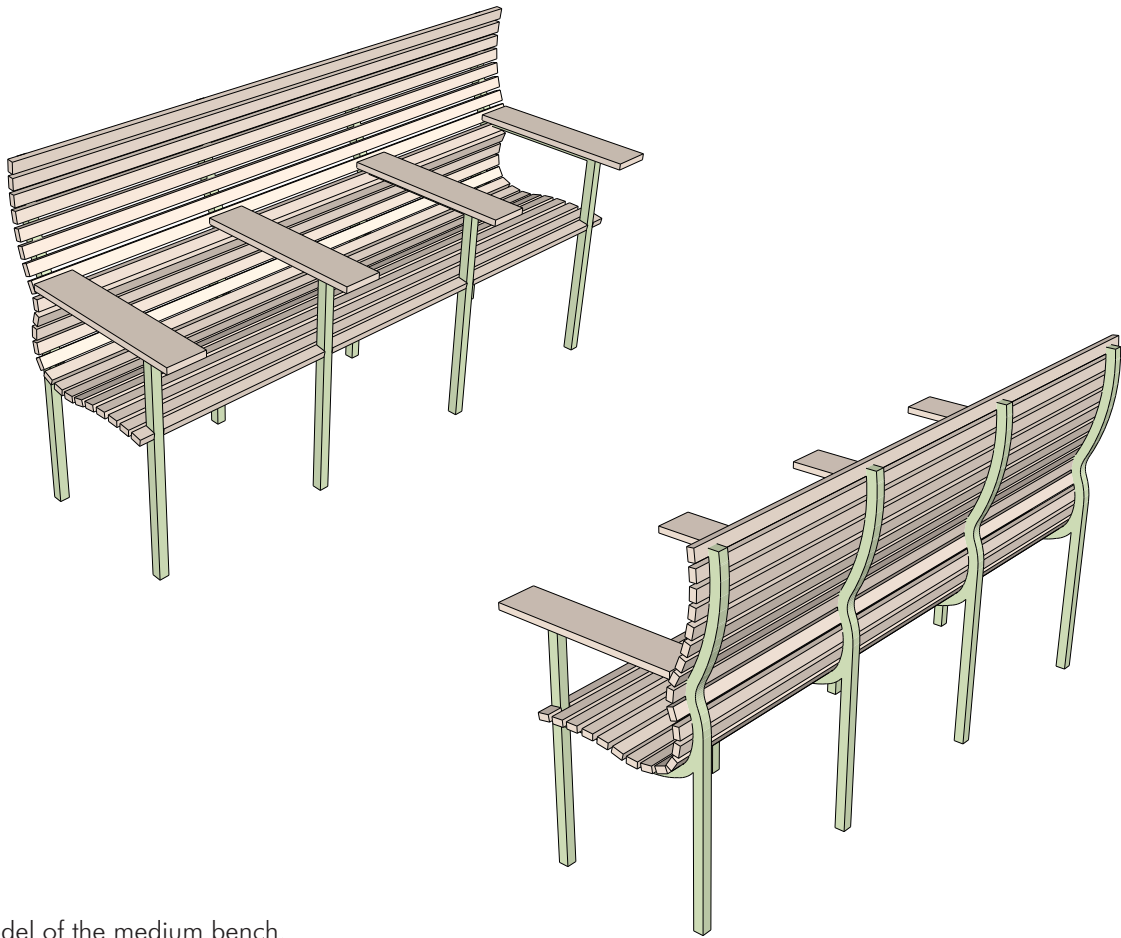

Model of the medium bench.

Benches could also have another health promotive effect - encouraging interaction and improving mental health. In Sweden, it is rather uncommon to start a conversation with a stranger or even sit next to one, as compared to other European countries. The benches are divided into individual seats - a potential user may be more inclined towards sitting with someone else as the bench is clearly separated into “armrests,” and possibly make a connection. There is an option of adding a table surface in the middle instead of a seat. Sharing a table also creates opportunities for the two neighbors to face each other and socialize.

BOULEBANA

The benches are used throughout the park and the Boulebana. The playing field is enjoyed by many residents, including older adults. However, it is very open and exposed to the surroundings, making it less private and pleasant to spend time in. Therefore, I decided to add a simple feature that also enhances the green atmosphere of the area (transition into a park) - bushes that enclose the space around the new benches, creating small semi-public zones for those who are playing the game. Each zone is a bit different - one includes benches with the shared tables, another one the classic benches shown in the previous page, and in the third one big tables are added.



Boulebona: new benches and greenery.

STAIRS

The site has multiple locations with height differences creating potential for using stairs as a health promotive element. Regular stair climbing may have beneficial effects on the health of older adults, especially in relation to heart rate and overall fitness (Donath et al., 2013). Similarly to seating, there are a variety of parameters and features to consider when aiming for the most suitable design for this target group. These relate to encouragement of use, ergonomics, comfort and safety.

The most commonly researched ideas to encourage use of stairs include attractive aesthetics, using posters for motivation, and ensuring they look safe (Arslan & Erkan, 2020). While most of these ideas are usually used to discourage use of elevators, they may also affect seniors' decision to continue walking around the site using the stairs. In both locations (near the two pavilions) nature and greenery were used to

make the experience more interesting and pleasant - a natural stone wall with grass, leading to the top of the hill between the trees, and a planted area in the other case.

Ergonomics, comfort and safety are connected and support one another. Stairs are often a cause of fall injuries (Arslan & Erkan, 2020), which relate to the common health conditions listed in the thesis before. Older adults may have less energy and strength, making them more vulnerable. As explained by Cohen et al. (2009), the elements that play a role in safety include handrails, lighting, consistency of dimensions and nosing strips.

Boverket recommends for handrails to be placed at 0,9 m height, which is the most suitable dimension for easy grp while losing balance (Boverket, 2019)(Afifi et al., 2014). Following the Swedish standard, they should extend at least 30 cm beyond the start and end of stairs as well as be clearly visible.

A study of lighting integrated in the stairs proved that users perceive climbing as safer when there is a light pointing downwards installed either at the edge of the stairs or in the handrail (van de Perre et al., 2019).

While specific measurements of steps are not as critical as ensuring that they are consistent throughout the whole elevation, it was found that riser height between 152 - 190 mm and depth between 280 - 330 mm are optimal (Afifi et al., 2014). Boverket recommends for the depth to be at least 300 mm (Boverket, 2019). They also mention the importance of marking the last and first step using contrasting colors.

Safety and comfort of walking may also be improved with the use of a short (15 - 25 mm) nosing and uniform materials in terms of slip resistance (Afifi et al., 2014). Pictures on the next page show how all the information described is applied to the site with the example of the stair near the Care and Fitness Pavilion. The stairs next to the Flex Pavilion follow the same design and are split into sections to appear less dangerous.

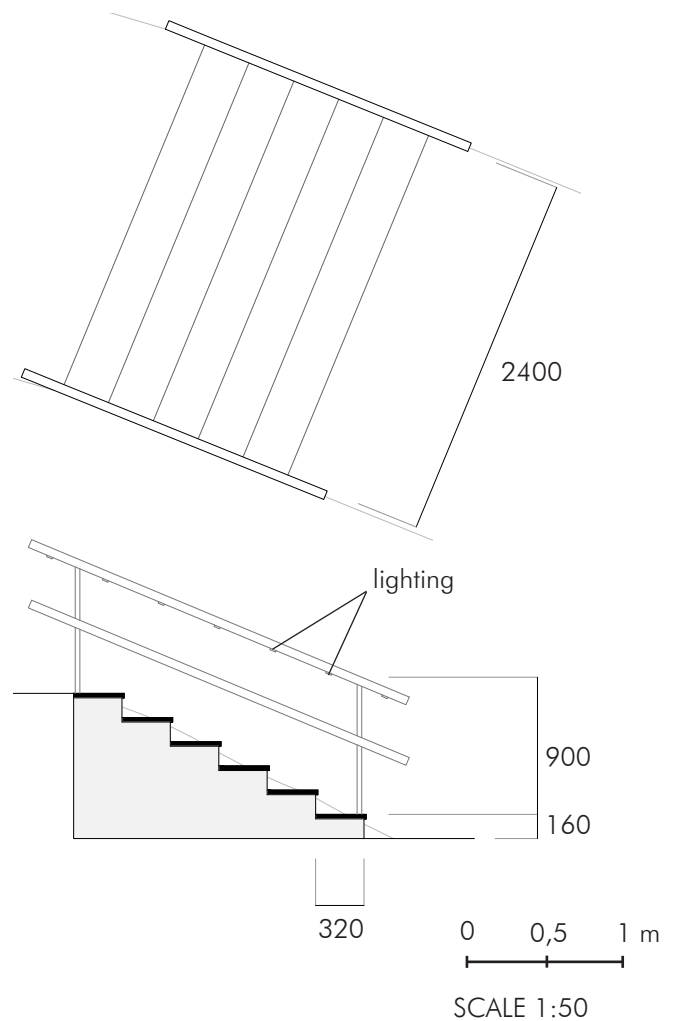

Dimensions of the stairs (top view and vertical section, in mm). The width is 2,4 m to match the age-friendly path widths.



Model of the stairs. The top material is dark natural stone with texture for anti-slip effect. The bottom and top steps are marked with white for clarity.

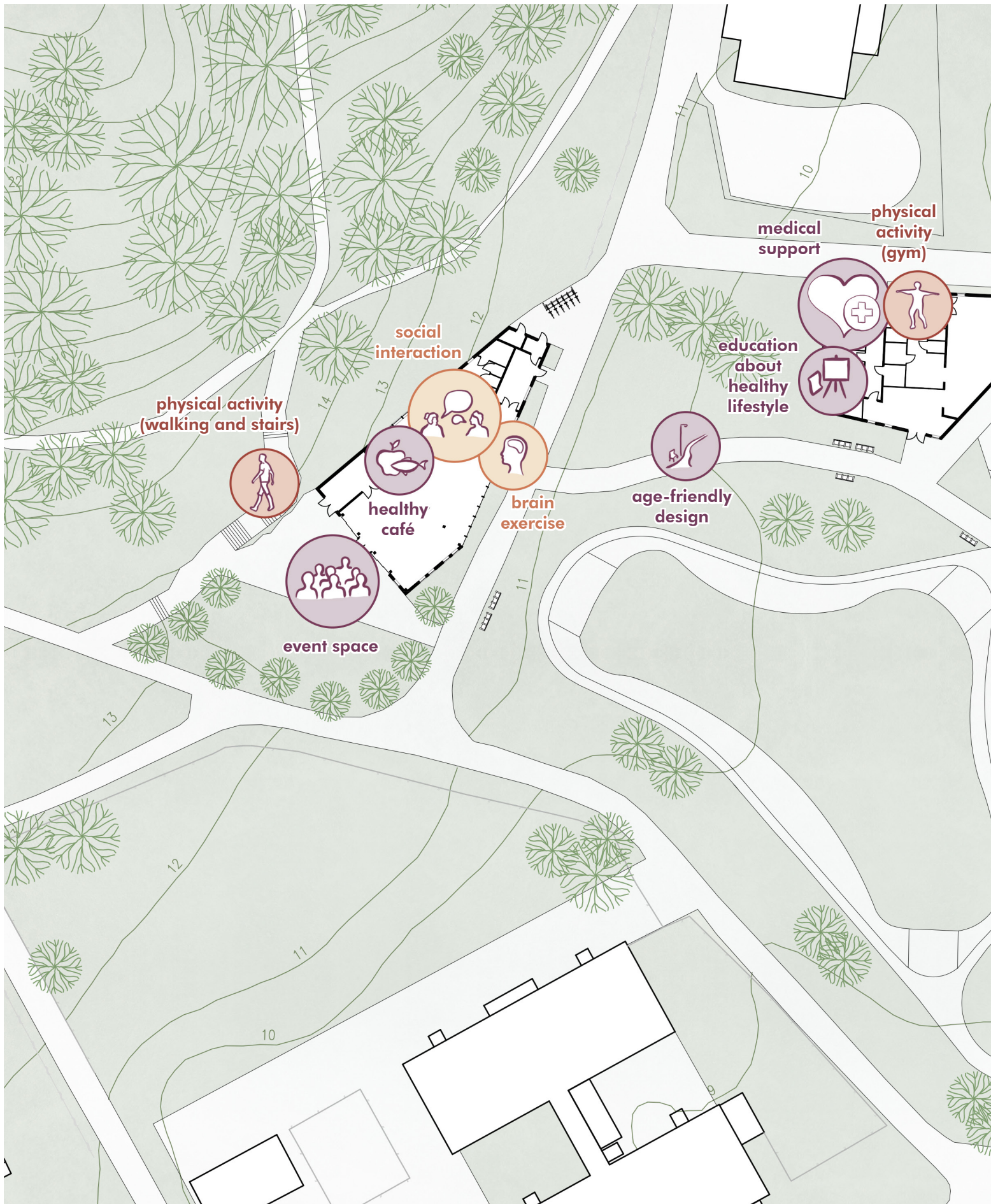

Overview of health promotive features and activities that the project encourages.

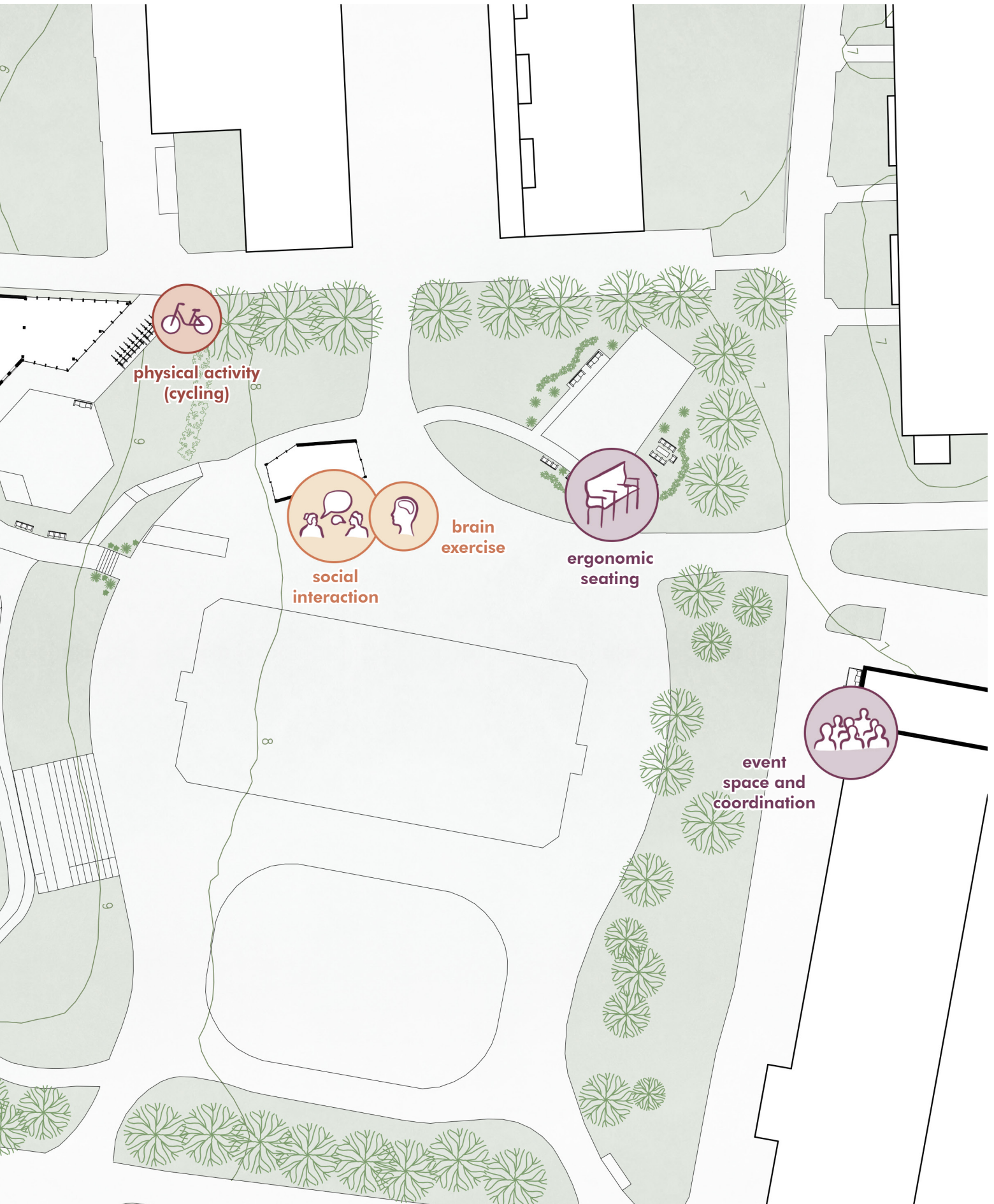

0 5 10 15 20 25 m

SCALE 1:500

6

DISCUSSION



Using health promotion as one of the solutions to the challenges posed by the aging society requires various fields to cooperate and bring in different considerations. Being one of these, architectural design could focus on the needs of the primary users and offer spatial solutions that enhance the health promotive effect. In this thesis, I aimed to explore this topic further, by designing a health promotive facility for older adults. The process required a variety of methods in order to build knowledge and a representative image of the context. Literature, including reference projects, and the site analysis formed a basis for close work with the target group. Participatory workshops conducted during the design phase were insightful and creative, supporting the entire process until the final details.

When designing a health promotive facility for older adults, it is essential to follow a holistic approach since many conditions are often related to one another and prevention is one of the key elements. Considering and acknowledging that the target group consists of a wide variety of people with different existing health problems, lifestyles and preferences is equally important and needs to guide the design to ensure that everyone can benefit from the result. Another key element in designing a facility of this kind, is to carefully evaluate decisions made on every scale, from urban to detail, and test every idea using the collected information. Having followed this approach, I strived to make logical decisions supported by the earlier developed knowledge and feedback from the older adults. Finally, involving future users in the process of creating a health promotive facility brings many advantages into the project as they are experts too. Not only is it insight, opportunity of feedback and unique ideas but it also empowers them and encourages them to take active part in health promotion as well as to lead a healthier lifestyle.

The thesis also proves that decisions made by an architect in a health promotive project for older

adults can directly affect the final result and success of the facility. Therefore, it is important for all stakeholders to be aware of that and, possibly, see it as a potential for better results. For an architect, it is a great responsibility which requires preparation and learning. The thesis shows an example of how a simplified design process could look, although in reality it would require a larger allocation of time spent on building knowledge. Hopefully, this project can serve as an inspiration as well as improve understanding of the process in user-centered design of a health promotive facility.

Since the project had several different phases, it was a challenge to explore some topics in depth. This applies especially to the literature studies which I found interesting and valuable in understanding the area of work. Due to the time limitation and strict planning, I needed to make compromises, select the most important information and decide where the moment of data being useful for architectural design ends. This was particularly challenging when designing in more detail, where all elements could affect the health promotive result, with each of them having its own path of research. A solution to that, which I did not include due to the extent of my work, could be involving medical specialists who could evaluate the ideas, for example through interviews or during the participatory workshops. Due to the research method, the number of workshops was limited. While I believe it was appropriate for the depth of this project, a real one would require more time allocated to those.

The thesis forms a basis with focus on the primary users - older adults. Further research could involve more participants in the workshops, while aiming for a hands-on co-creation. Conducting similar activities as well as interviews with secondary users or other stakeholders involved in the project would result in a valuable outlook on the experiences of others.

REFERENCES

- Afifi, M., Parke, B., & Al-Hussein, M. (2014). Evidence-Based Evaluation of Staircase Architectural Design to Reduce the Risk of Falling for Older Adults. *Journal of Housing For the Elderly*, 28(1), 107–132. <https://doi.org/10.1080/02763893.2013.858095>
- ArchDaily. (2012, May 31). *Falcognana Elderly Center / laN+*. https://www.archdaily.com/239430/falcognana-elderly-center-lan?ad_source=search&ad_medium=projects_tab
- ArchDaily. (2019, January 26). *The Jean Bishop Integrated Care Centre / Medical Architecture*. https://www.archdaily.com/909641/the-jean-bishop-integrated-care-centre-medical-architecture?ad_source=search&ad_medium=projects_tab
- Arslan, M., & Erkan, I. (2020). A model for evaluating the user satisfaction of human movements on stairs through the ergonomic design approach. *Theoretical Issues in Ergonomics Science*, 22(6), 651–672. <https://doi.org/10.1080/1463922x.2020.1852335>
- BLACK + DECKER. (n.d.). *DIY Outdoor Checkers Game Table*. [Photograph]. Pinterest. <https://www.pinterest.com/pin/364158319851689275/>
- Blackler, A., Brophy, C., O'Reilly, M., & Chamorro-Koc, M. (2018). Seating in aged care: Physical fit, independence and comfort. *SAGE Open Medicine*, 6, 1–17. <https://doi.org/10.1177/2050312117744925>
- Boverket. (2019). *Boverket's mandatory provisions and general recommendations*, BBR.
- Center of Design for an Aging Society. (n.d.). *Ease and Accessibility*. <http://www.centerofdesign.org/pages/easeaccessability.htm>
- Cohen, J., LaRue, C. A., & Harvey Cohen, H. (2009). Stairway Falls. An ergonomic analysis of 80 cases. *Professional Safety*, 54(1), 27–32.
- Donath, L., Faude, O., Roth, R., & Zahner, L. (2013). Effects of stair-climbing on balance, gait, strength, resting heart rate, and submaximal endurance in healthy seniors. *Scandinavian Journal of Medicine & Science in Sports*, 24(2), e93–e101. <https://doi.org/10.1111/sms.12113>
- Edvinsson, J., Rahm, M., Trinks, A., & Höglund, P. J. (2015). Senior Alert: A Quality Registry to Support a Standardized, Structured, and Systematic Preventive Care Process for Older Adults. *Quality Management in Health Care*, 24(2), 96–101. <https://doi.org/10.1097/qmh.0000000000000058>
- Göteborgs Stad. (2019). *Basutvärdering: Nulägesbeskrivning av seniorers behov, erfarenheter och synpunkter om åldersvänligheten i Göteborg*. https://issuu.com/vartgoteborg/docs/goteborgs_stad_rapport_190506_tillg

- Hanson, L., Sperling, L., Gard, G., Ipsen, S., & Olivares Vergara, C. (2009). Swedish anthropometrics for product and workplace design. *Applied Ergonomics*, 40(4), 797–806. <https://doi.org/10.1016/j.apergo.2008.08.007>
- IaN+. (2012, May 31). *Falcognana Elderly Center* [Illustration]. ArchDaily. https://www.archdaily.com/239430/falcognana-elderly-center-lan?ad_source=search&ad_medium=projects_tab
- Kemm, J., & Close, A. (1995). *Health Promotion: Theory and practice*. PALGRAVE. <https://doi.org/10.1007/978-1-349-12971-3>
- Lannering, C., Ernsth Bravell, M., & Johansson, L. (2016). Prevention of falls, malnutrition and pressure ulcers among older persons - nursing staff's experiences of a structured preventive care process. *Health and Social Care in the Community*, 25(3), 1011–1020. <https://doi.org/10.1111/hsc.12400>
- Lennartsson, C., & Heimerson, I. (2012). Elderly people's health: Health in Sweden: The National Public Health Report 2012. Chapter 5. *Scandinavian Journal of Public Health*, 40(Suppl 9), 95–120. <https://doi.org/10.1177/1403494812459468>
- Lindwall, M., Rennemark, M., Halling, A., Berglund, J., & Hassmén, P. (2007). Depression and Exercise in Elderly Men and Women: Findings from the Swedish National Study on Aging and Care. *Journal of Aging and Physical Activity*, 15(1), 41–55. <https://doi.org/10.1123/japa.15.1.41>
- Lindwall, M., Rennemark, M., & Berggren, T. (2008). Movement in mind: The relationship of exercise with cognitive status for older adults in the Swedish National Study on Aging and Care (SNAC). *Aging and Mental Health*, 12(2), 212–220. <https://doi.org/10.1080/13607860701797232>
- Marziali, N. (2012, May 31). *Falcognana Elderly Center* [Photograph]. ArchDaily. https://www.archdaily.com/239430/falcognana-elderly-center-lan?ad_source=search&ad_medium=projects_tab
- Medical Architecture. (2019, January 26). *The Jean Bishop Integrated Care Centre* [Illustration]. ArchDaily. https://www.archdaily.com/909641/the-jean-bishop-integrated-care-centre-medical-architecture?ad_source=search&ad_medium=projects_tab
- Mölndals Stad. (2022a, January 10). *Hälsans stig*. <https://www.molndal.se/startside/uppleva-och-gora/idrott-motion-och-friluftsliv/friluftsliv-och-motion/vandringsleder/halsans-stig.html>
- Mölndals Stad. (2022b, January 19). *Träffpunkter*. <https://www.molndal.se/startside/omsorg-och-hjalp/aldre/traffpunkter.html>
- Mölndals Stad. (2022c, February 10). *Omsorg och hjälp: Äldre*. <https://www.molndal.se/startside/omsorg-och-hjalp/aldre.html>
- Mölndals Stad. (2022d, February 10). *Träffpunkten centrum och Café Möllan*. <https://www.molndal.se/startside/omsorg-och-hjalp/aldre/traffpunkter/traffpunkten-centrum.html>

- Mölnåls Stad & Lantmåteriet. (n.d.). *Mölnålskartan*. Mölnålskartan. <https://karta.molndal.se/spatialmap>
- National Board of Housing, Building and Planning. (2004, September). *Swedish Legislation: Accessibility and usability in public spaces BFS 2004:15 - ALM 1* (No. 978–91-86045-60–9).
- NHS Hull Clinical Commissioning Group. (n.d.-a). *Integrated care centre consultation*. Creating a Healthier Hull. <https://www.hullccg.nhs.uk/have-your-say/past-consultations/integrated-care-centre-consultation-26-january-2015-19-april-2015/>
- NHS Hull Clinical Commissioning Group. (n.d.-b). *Integrated Care Centre (ICC)*. Creating a Healthier Hull. <https://www.hullccg.nhs.uk/integrated-care-centre-2/>
- Nitz, J. C. (2000). The seating dilemma in aged care. *Australian Journal of Physiotherapy*, 46(1), 53–58. [https://doi.org/10.1016/s0004-9514\(14\)60314-7](https://doi.org/10.1016/s0004-9514(14)60314-7)
- Östnås, B., & Leufstadius, N.-F. (1963, February). *Göteborg-Bohus Mölnåls sn* (No. 14-MÖL-5355). Mölnåls Stad.
- Partheen, E. (1969). *Göteborg-Bohus Mölnåls sn* (No. 14-MÖL-6478). Mölnåls Stad.
- Paula, A. (n.d.). *How to design a functional Senior Park?* Lappset. <https://www.lappset.com/News-and-updates/Blogs-and-articles/Designing-a-Senior-Park>
- Pensionsmyndigheten. (2022, January 28). *Korta pensionsfakta*. <https://www.pensionsmyndigheten.se/statistik-och-rapporter/statistik/kortapensionsfakta>
- Public Health Agency of Canada. (2015). *Age-friendly Communities Evaluation Guide: Using indicators to measure progress*. Public Health Agency of Canada. <https://www.canada.ca/content/dam/phac-aspc/migration/phac-aspc/seniors-aines/alt-formats/pdf/indicators-indicateurs-v2-eng.pdf>
- SCB, Statistiska centralbyrå. (2018). *Sveriges framtida befolkning 2018–2070*. SCB, Avdelning Befolkning och Välfärd. https://www.scb.se/contentassets/b3973c6465b446a690aec868d8b67473/be0401_2018i70_br_be51br1801.pdf
- Schön, P., Lagergren, M., & Kåreholt, I. (2015b). Rapid decrease in length of stay in institutional care for older people in Sweden between 2006 and 2012: results from a population-based study. *Health and Social Care in the Community*, 24(5), 631–638. <https://doi.org/10.1111/hsc.12237>
- Scott, A., Stride, V., Neville, L., & Hua, M. (2014). Design and promotion of an outdoor gym for older adults: A collaborative project. *Health Promotion Journal of Australia*, 25, 212–214. <https://doi.org/10.1071/he14037>
- Senior Göteborg. (2019). *Basutvärdering: Nulågesbeskrivning av seniorers behov, erfarenheter och synpunkter om åldersvänligheten i Göteborg*. Göteborgs Stad.

- Socialstyrelsen. (2018, October). *Psykisk ohälsa hos personer 65 år och äldre: Uppföljning av vård och omsorg vid psykisk ohälsa hos äldre. Öppna jämförelser*. <https://www.socialstyrelsen.se/globalassets/sharepoint-dokument/artikelkatalog/oppna-jamforelser/2018-9-12.pdf>
- Stockholm Gerontology Research Center, Aging Research Center, Karolinska Institutet, & Stockholm University. (n.d.). *Results. Lifestyle behaviors and longevity*. SNAC-K Population Study. <https://www.snac-k.se/research/results/>
- Sveriges Kommuner och Regioner. (2020, June). *Fakta om äldreomsorgen - i ljuset av coronapandemin*. <https://rapporter.skr.se/fakta-om-aldreomsorgen.html#>
- Taylor, D. (2014). Physical activity is medicine for older adults. *Postgraduate Medical Journal*, 90, 26–32. <https://doi.org/10.1136/postgradmedj-2012-131366>
- United Nations, Department of Economic and Social Affairs, Population Division. (2019a). *World Population Prospects 2019: Highlights*. United Nations. https://population.un.org/wpp/Publications/Files/WPP2019_Highlights.pdf
- United Nations, Department of Economic and Social Affairs, Population Division. (2019b). *World Population Ageing 2019: Highlights*. United Nations. <https://www.un.org/en/development/desa/population/publications/pdf/ageing/WorldPopulationAgeing2019-Highlights.pdf>
- Valmyndigheten. (2018, September 14). *Val till kommunfullmäktige i Mölndal - Ålder och kön - kommun Mölndal*. <https://data.val.se/val/val2018/alkon/K/kommun/14/81/alderkon.html>
- van de Perre, L., Danschutter, S., Janssens, K., Hanselaer, P., Dujardin, M., Smet, K. A., & Ryckaert, W. R. (2019). Safety perception of stairs with integrated lighting. *Building and Environment*, 166. <https://doi.org/10.1016/j.buildenv.2019.106389>
- Western Australian Council of Social Service. (2017). *Co-Design Toolkit* [E-book]. Western Australian Council of Social Service.
- Witt, S., Englander, E., Kumlien, C., & Axelsson, M. (2018). Mismatch between risk factors and preventive interventions? A register study of fall prevention among older people in one Swedish county. *International Journal of Older People Nursing*, 13(4). <https://doi.org/10.1111/opn.12209>
- World Health Organization. (n.d.). *About Us. What is an age-friendly world?* WHO: Age-Friendly World. <https://extranet.who.int/agefriendlyworld/about-us/>
- World Health Organization. (2020, December 9). *WHO reveals leading causes of death and disability worldwide: 2000-2019*. <https://www.who.int/news/item/09-12-2020-who-reveals-leading-causes-of-death-and-disability-worldwide-2000-2019>

APPENDIX

WORKSHOP - ÅBY AND HEALTH

The results from this workshop will be shared with Mötesplats Åby and Chalmers University. My final work shared publicly in the library will not include any identifying answers or notes.

1. In this part we'll focus on the big map. I would like you to help me understand this place in your experience, because you know it much better than me. It's great if you discuss and write down some notes about the reasons why you chose those specific locations.

You got a slip of round stickers with different colours. Please put...

... a **BLACK** sticker near your home. If you don't live in this area, put the sticker outside of it.

... **YELLOW** stickers in locations you would choose to meet with your friends. Is there anything special there? For example a café or sitting places?

.....
.....

... **RED** stickers in locations you like the least or dislike in this area. Can you tell me why you chose them?

.....
.....

... **BLUE** stickers in locations you find pleasant to be in. Can you tell me why you chose them?

.....
.....

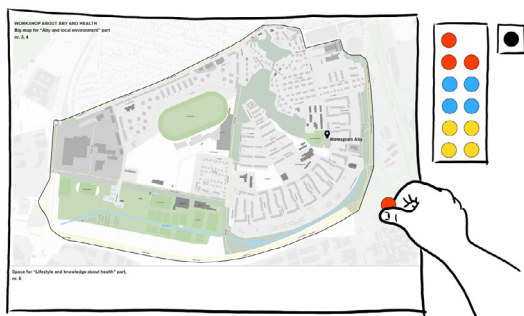

1

2. Discuss with others what are the ways of looking after one's physical and mental health. Make it as specific as possible. Together write them down on the post-its and put them in the categories under the big map. You can also add new categories!

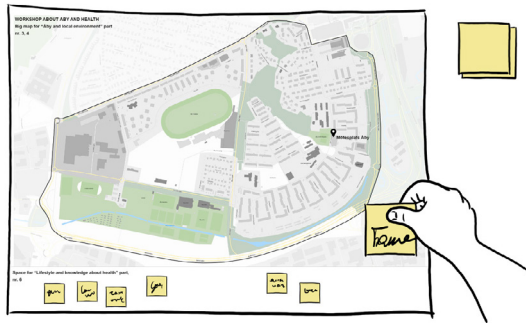

After that, put...

... **GREEN** stickers on the post-its with the things you do regularly.

... **BROWN** stickers on the ones you think are not pleasant (stressful or not enjoyable; even if you haven't tried them yet). This may also include some of the things you marked with green.

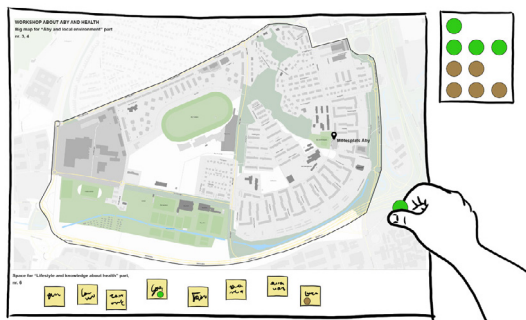

3. The task should be answered collectively as a group.

a. Imagine that all of you are responsible for organizing an event for older adults about staying healthy (information, exercise and social interaction). Which 2 locations in the area on the map (outdoor or indoor) would you choose to reach out to as many older adults as possible? Place the “event” cards there. Can you write down a few reasons why you think this location is good?

.....
.....

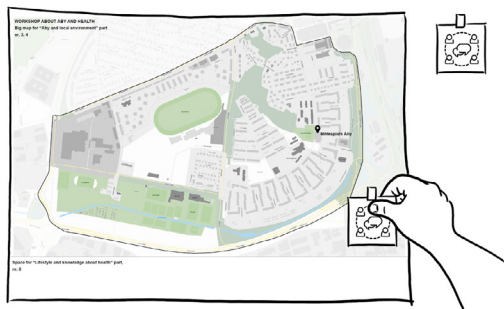

b. Together, think of a nice walking route that you could take in the area shown on the big map. Draw the route with a marker. Then use a few cards with different pictures to show what is on the way, by sticking them on the map.

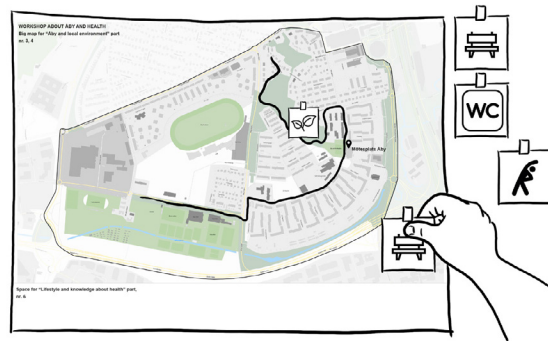
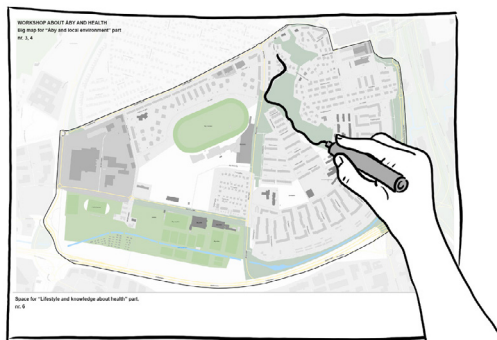

Thank you so much for participating! Is there anything else you'd like to share that's related to Åby or health promotion?

.....
.....
.....

