

Taglamyren Naturum Visitor Centre

Adapting Swedish timber building traditions for today's needs



Master Thesis in Architecture
Building Design & Transformation | Spring 2024

Taglamyren Naturum Visitor Centre

Adapting Swedish timber building traditions for
today's needs

Author: Sam de Jong

Chalmers University of Technology
Department for Architecture and Engineering
MPARC Architecture and Urban Design

Supervisor: Björn Gross
Examiner: Mikael Ekegren



CHALMERS



Abstract

Farm buildings have played a significant role in shaping the Swedish landscape for centuries. The farm buildings have evolved in response to the changing needs of farmers over time and therefore showcase historical and cultural heritage as well as special building techniques. However, this knowledge is at risk of fading away as modern demands deviate from the traditional methods. Traditional timber constructions, while rich in heritage, often fall short of contemporary standards for energy efficiency and resilience.

This thesis aims to bridge the gap between tradition and modernity by adapting traditional construction methods to meet present-day needs and standards, thereby preserving the cultural significance of these buildings. To achieve this goal, a new naturum visitor centre, accompanied by a complementary birdwatching tower will be designed in the nature reserve Taglamyren, located in the province of Småland. Naturum visitor centres are known for their distinctive architecture, serving not only to educate visitors about nature and the environment but also to inspire them to engage with nature themselves.

Taglamyren nature reserve is a landscape of wide spread and untouched bog, presenting a challenge in integrating structures without disturbing nature and the landscape.

The design process will be divided into two stages: firstly, an exploration of the historical and technical aspects of farm buildings in Småland, along with an exploration of local vernacular architecture and contemporary references; secondly, an iterative design process informed by the findings of the initial research.

The outcome will be a naturum visitor centre that reimagine local timber construction traditions in to a robust construction method. In addition to the naturum there also is a birdwatching tower inspired from the vernacular building techniques. By preserving cultural heritage while embracing innovation, this project seeks to ensure the continued relevance and resilience of traditional building practices for generations to come.

Keywords: Naturum; Building Tradition; Timber Construction; Post and Planks

Sam de Jong



M.Sc Architecture and Urban Design

2022-2024 Chalmers University of Technology

Studios:

Fall 2022 - Architecture and Urban Space Design

Spring 2023 - Matter, Space, Structure 2

Summer 2023 - Från Idé Till Färdig Byggnad

Fall 2023 - Building Tectonics 2

B.Sc Architecture and Engineering

2018-2021 Chalmers University of Technology

Own Architecture Studio

2021 Onwards

Contents

Introduction

Discourse	8
Aim & Purpose	8
Thesis Question	8
Method	8
Delimitations	8

Background

Pre Study	10
Building Tradition	12
Building Techniques	16
Corner Joint & Timber Frame	16
Post & Planks	18
Development	20
Naturum Visitor Centre	22
The Site	24
Reference Projects	28
Naturum Store Mosse	28
Yomogidai House	30
Antbrufossen Vannbruksmuseum	32
Periscope Tower	34
Program	36
Program	36
Design Concepts	37

Design Proposal

Nature Reserve	38
Site plan	38
Concept	39
Naturum	40
Concept	40
Situation Plan	42
Floor Plan	44
Elevations	46
Sections	48
Exploded Detailed Axo	49
Structural Principle	50
Model - Structure	51
Detail Cuts	52
Model - Building	54
Birdwatching tower	56
Concept	56
Situation Plan	58
Floor Plans	60
Elevations	62
Exploded Axo	66
Model - Building	68

Conclusion & Discussion

Bibliography

Discourse

Aim & Purpose

The general aim of the project is to develop new ways of using traditional timber building techniques. The old farm building is a building typology that is an important part of Sweden's architectural history and a big part in the landscape. But they are threatened to disappear as many do not have a purpose anymore.

By understanding the buildings; how they were built, what they were used for, why they look the way they do, the goal is to translate and develop the buildings historical and structural qualities into something new and interesting. The architecture should tell multiple stories, not forgetting its cultural value, but at the same time challenge the architecture becoming a robust building inspired from the past but belonging to today and for many years to come.

The idea of the project is to create a naturum and a birdwatching tower along a walking path for a nature reserve in Kronoberg county. The reserve is a large untouched bog and the goal is that the new naturum and birdwatching tower respects its surroundings. By respecting its surroundings and the building traditions in this location I hope to form buildings that inspire visitors to explore nature for themselves and that can show how nature and architecture can work together. By design explorations and reference work I hope to find a good way for the building to meet the ground in a respecting way and to develop the techniques.

Furthermore the project should explore and give more insight on traditional building techniques and timber woodworking. Training me in to then determine suited strategies for the project.

Thesis Question

How can developing the traditional timber building techniques, for today's needs, contribute to the revitalization of the building type and highlight the importance of their cultural heritage?

Method

The thesis process consists of two primary phases, with the initial stage dedicated to delving into the background and essence of the location through site visits and documentation. Through an exploration of local vernacular architecture and contemporary reference projects, I seek to gain insights into materials, techniques, and forms that can inform and enrich our design decisions.

Also, studying the building technique and how it has evolved over time as well as looking at new solutions based on the old traditions will be done to understand how to develop and create a new interpretation of these building types.

The second part of the thesis is about an iterative design process using these explorations to create a naturum with a complementary birdwatching tower. Sketching, making drawings and creating models will be made to present as well as exploring and understanding the design choices that will be made.

Delimitations

Farm buildings look, even if there is a fundamental basis, quite different in different counties. Therefore the area of research will be limited to Småland, the province where the site is located. This will also keep the end result more connected to the local building traditions and more authentic in that sense.

The conditions of the site and the general ideas of a naturum will together with the existing building form the end-result and the possibilities. But to not create too many limitations the eventual building regulations on the site will not be considered. Also the conditions of the soil will not be considered when creating the foundation of the building.

The question of whether an old farm building can be considered architecture or not has come up during early discussions, since most of these buildings are made without architects. This is an interesting thing to discuss and will be a part of this thesis but it will not become a main discussion point since this could be a research question on its own.





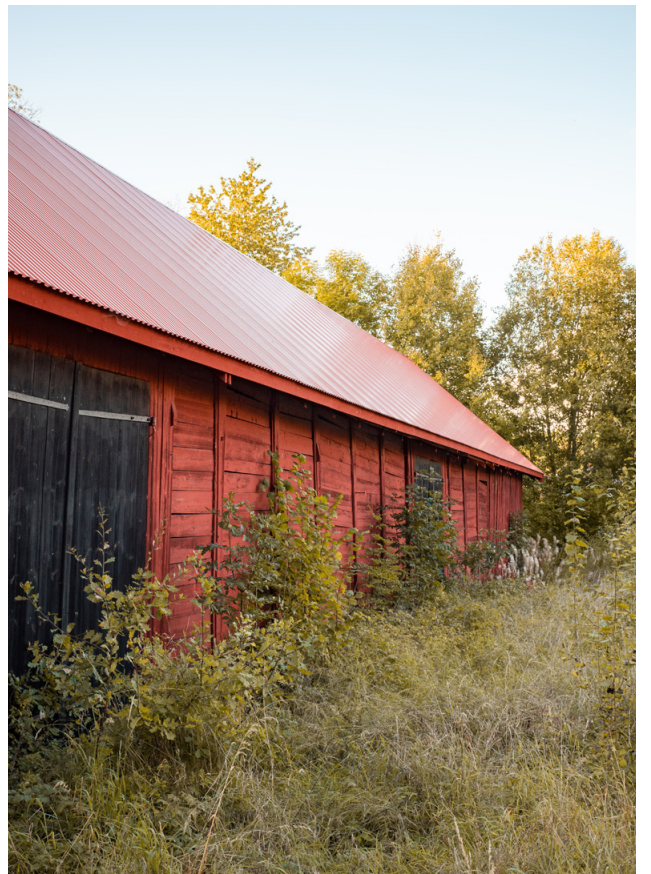



When driving around and more carefully looking for the building typology on the country side in Kronoberg I realised how many different building types there are and how they also are built with different techniques. Sallnäs et al. (2004) mentions how there still are many old farm buildings in Kronoberg county showing a rich building tradition. But we can also see how many buildings are lacking in maintenance because of lack of time, money and interest.

The buildings have during generations been changed and transformed when conditions and needs have changed. Therefore the farm buildings have a big cultural value in the way they show traditions and evolution. Today we prioritize other things because many of the buildings are not up to standard or needed anymore and therefore lack function. The buildings that are the most threatened are meadow barns because of their distance to the main farm buildings according to Sallnäs et al. (2004). This is also something I noticed when driving around. To save the building tradition Sallnäs et al. (2004) suggests to give these buildings new purposes.

Until the end of the 18th century the cultivation was done jointly within the villages. The buildings were design and sized for what they needed and the materials they used was what they could find locally. It was not uncommon to reuse materials from old buildings either. In the beginning of the 19th century there was a land reform (laga skifte) in Sweden where the farmlands were split between the farms. Some farms needed to move when this happened and the whole village would then help out. Because of the way the buildings were built it was not unusual to dismount the buildings and move them to the new site. The farms that moved were often placed strategically and also got extra land as a form of compensation.

Cultivating the land became more controlled by the individual farm which led to a development within the farming and production raised. The needs for buildings changed and more places to store hay and grain were needed. Furthermore Sallnäs et al. (2004) also mention the economical growth because of this and the farms invested more in good buildings.

The land reform made the disposition of the individual lands more free and the "clean" and "dirty" activities became more separated (Sallnäs et al., 2004). For the "dirty" activities the **barn** was the central point, a place where the cows would be gathered. C. E. Löfvenskiöld is one of the most known building masters whose drawings were spread over Sweden when the need of good buildings raised in conjunction with the agrarian revolution that came with the land reform. Löfvenskiöld found inspiration from all over Europe, maybe most from Switzerland. The barns had higher trusses and therefore more height as well as bigger doors so they could go in with hay carts to minimize the manual labour. They also often had stone foundations that were more resistant to moisture. Many of the buildings were decorated with so called "snickarglädje" to empathize on them being proud off the farm and on the belief in the future.

Summer barns where, as the name suggests, mainly used during the summer. When bovine animals were out on the grassland the farmers did not want to move them all the way back to the main barn. Instead they had a smaller barn out by the grassland. Sallnäs et al. (2004) believe there have been many more, but there still are a few left in the county. The building technique I saw out exploring was timber frame barns but they could also be so called "skiftesverk" (post and plank structures).

Stables are uncommon in Kronoberg county (Sallnäs et al., 2004). Horses often were in the same building as, but separated from, the cows. In Kronoberg only churches had separate stables and therefore they are often still in good condition today.

The type of building that seemingly is has been unused for longest is the **meadow barn**. Driving around, I thought these were very interesting because of the way they lay in the middle of the fields with a small road leading to them. The purpose of a meadow barn was to get hay and grains away from the wet meadows (Sallnäs et al., 2004). When the winter came and the ground froze they moved the hay and grains back to the farm and the animals. These smaller barns are in Kronoberg county in many cases built with timber frames and wood panelling, but do also exist as timber post and plank structures.

Root cellars where necessary to keep food good during the whole year. Temperatures could be kept stable because of the way they sat under ground. They were here mainly made out of rock. Today many roofs have collapsed but the stone walls are left and are a big part of the landscape still today (Sallnäs et al., 2004).

Forges are not common anymore but were not uncommon back in the days. The reason they are not common today is because many were burnt down since they all had fireplaces to be able to forge. Forges were most of the time timber buildings with a central chimney. The building was placed away from other buildings on a safe distance in case of fire.

Every farm had a "**Brygghus**". This building was where they boiled water to wash. Similar to the forges the "brygghus" was placed away from other buildings since they also had a fireplace. The early examples were made with a timber log structure but most after the 19th century were timber frame structures with wooden panelling.

Storehouses were well built, Bodin (2020) says that they probably are the most well built of the different buildings. Safe from moisture, pests and burglary. This was where they stored all their belongings and it was like a treasure-house and the farmers' pride (Sallnäs et al., 2004). The storehouses were usually timber buildings with two or more stories depending on the wealth on the farm. One invested also in the details and therefore these often are extra beautiful. Today these are often the oldest building on farms and are still taken care of since people see their cultural value.

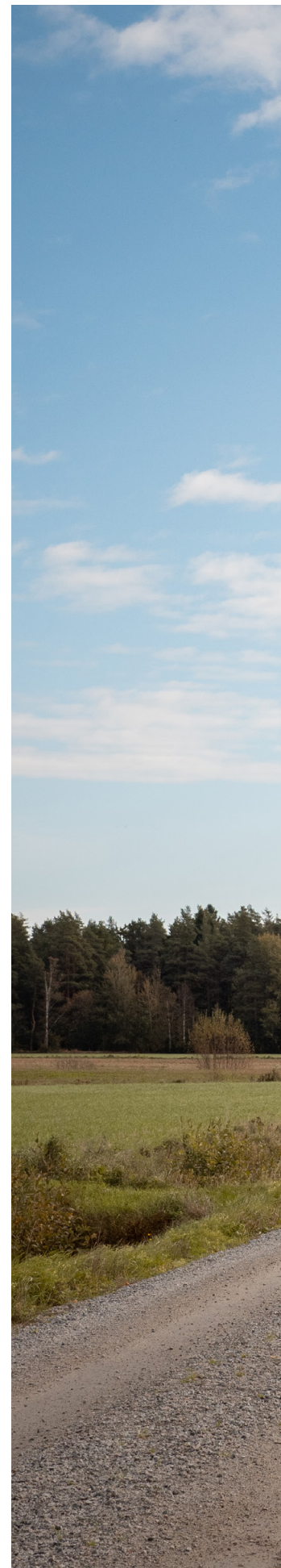



The tradition of timber log construction runs deep in the Nordic countries, with a rich history dating back centuries. This age-old technique involves stacking timber logs atop one another, interlocking them at the corners through precise cutouts, creating a sturdy and enduring structure. Through my research, primarily drawn from Rosander's work "Knuttimring i Norden: Bidrag till dess äldre historia" (1986), I've uncovered insights into the evolution and diverse methods of this craft.

One of the prominent techniques observed is the corner joint, known as "dubbelhaksknut" in Swedish (seen in the top left corner). Rosander (1986) traces its origins to the gutter knot ("ränknut") of the medieval era, which evolved to meet the heightened demands of the 19th century. As requirements for insulation and protection of livestock and crops increased, the corner joint underwent refinements, becoming more prevalent in construction practices.

Notably, a benefit of timber log structures lies in their disassembly and portability. The logs securely interlock without the need for fastenings, facilitating relocation, a feature particularly significant during periods of land reform. Structures were often moved or transformed into "skiftesverk," showcasing the adaptability and resourcefulness inherent in this architectural tradition. Skiftesverk or "post an planks" will be described more in a later section.

Another of the defining features of the corner joint is its adaptability to varying timber dimensions and qualities. Builders carefully carve each notch to accommodate the characteristics of the timber, ensuring a precise fit that maximises structural integrity. This bespoke approach to joinery is a testament to the skill and craftsmanship seen in Swedish timber structures throughout history.

Central to the functionality of the corner joint is its ability to resist both vertical and lateral forces. By tightly interlocking adjacent logs, the joint distributes loads evenly across the structure, minimizing the risk of settling or deformation over time, as long as the foundation is good. Additionally, the angled configuration of the notches provides inherent resistance to shear forces, further enhancing the structural stability of the building.

Another notable technique is the dovetail joint, or "laxknut" (seen on the top right corner), which is a development of the corner joint and gained popularity with the beginning of panel cladding. The dovetail joint is characterized by its trapezoidal shape, reminiscent of a dove's tail, this joint provides a clean and elegant transition between adjacent logs. As buildings began to be sheathed in panels for added protection a clean and seamless corner became essential. Originally employed in church construction, the dovetail joint found its way into farm buildings during the 19th century, driven by the need for improved weather

resistance and aesthetic appeal in form of wooden panelling. Its adaptation from church construction to farm buildings demonstrates the evolution and of architectural practices over time and how inspiration where taken from one architectural type and developed for another.

Despite the intricate joinery, timber log structures remain disassembleable also with the dovetail connection. The inherent beauty of this connection serves as a testament to the skilled hands that shaped these structures.

In contrast to the material dense timber log structure, timber frames, or "stolpverk", offer a lightweight and versatile alternative for construction. Characterized by timber posts, beams, and slanted struts, timber frames rely on half lap joints to achieve structural stability. While not as easily disassembled as log structures, they present their own charm and functionality well suited for meadow barns and other farm buildings that benefit from an airy structure. However, exposure to the elements often leaves them in lesser condition compared to their log built counterparts. At least when not taken care of. Skilfully jointed logs contribute to the rigidity and stability of these structures, as seen in timber-framed meadow barns observed during my photographic study. The panels enable easier care taking than the timber log buildings, but even if these buildings are easier to take care of the buildings are often seen as less important to preserve and are therefore often in lesser condition.

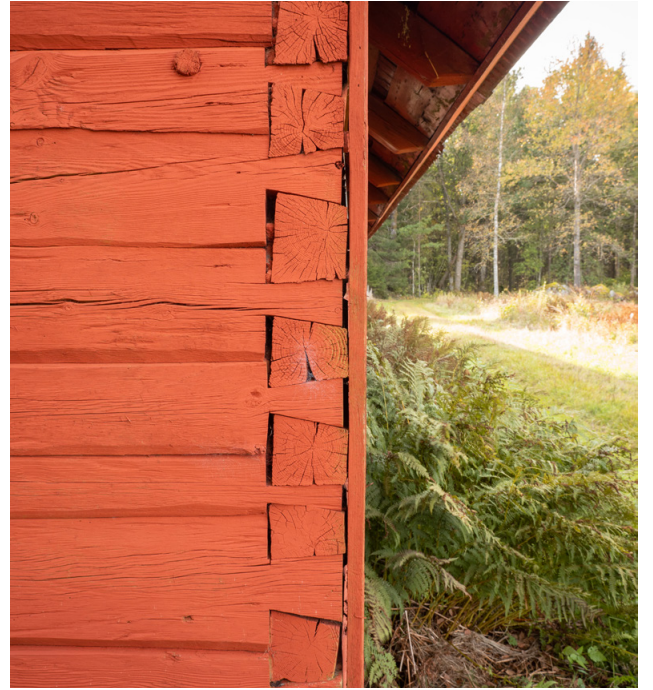

The tradition of timber log construction in the Nordic countries has evolved over centuries. Among these, the practice of “skiftesverk” or post and plank structures evolved, that could be seen as a combination of timber log and timber frame structures. Post and plank, as its name suggests, is a modular construction approach characterised by the combination of corner posts and inserted planks or logs. Henriksson (1996) describes this technique as a departure from the solid timber log structures, offering a more lightweight and adaptable alternative. The construction process, typically involves the use of oak for corner posts and lower structural elements, ensuring longevity and stability.

Central to the concept of skiftesverk is its adaptability to varying timber dimensions and growth patterns. Unlike traditional timber log structures, which often require lengthy logs for uninterrupted stacking, skiftesverk accommodates shorter logs or planks inserted into grooves in the corner posts. This design flexibility not only optimises timber utilisation but also aligns with historical realities, particularly in regions where trees were of limited height or quality. It also allows for old timber logs and planks to be reused.

The modular nature of skiftesverk lends itself to ease of assembly and disassembly, a feature also seen with timber log buildings. This feature was important during the periods of land reform where farmlands were split between farms during the 19th century (Sallnäs et al. 2004). Structures could be dismantled and relocated with relative ease, ensuring the continuity of agricultural practices and community life.

While post and planks shares similarities with timber log structures in terms of disassembly, its construction methodology diverges significantly. Rather than relying on interlocking joints or dovetail connections, skiftesverk hinges on the secure insertion of planks or logs into grooves in the corner posts. This design choice prioritises versatility and adaptability, allowing for rapid assembly and customisation to suit specific spatial or functional requirements.

Integrating skiftesverk construction into the design of a naturum visitor centre offers an opportunity to blend traditional Swedish craftsmanship with contemporary architectural principles. This approach not only celebrates cultural heritage of the area but also aligns with sustainability goals by utilising renewable materials and embracing modular construction techniques. Skiftesverk's versatility allows for flexible spatial configurations, creating engaging experiences for visitors. Aesthetically, its timeless expression resonates with the surrounding landscape and preserves the historical heritage in a new building.

While skiftesverk construction offers inherent charm and adaptability, ensuring its suitability for a public building like a Naturum visitor centre requires addressing insulation requirements. Incorporating insulation into skiftesverk structures may require a multi-faceted approach that considers both material selection and construction techniques. Traditional methods such as adding additional layers of timber or incorporating natural insulating materials like straw or wool between planks can enhance thermal performance without compromising the aesthetic integrity of the structure but might not be an efficient way economical for this type of building. Exploring modern insulation technologies such as rigid foam panels or aero gel blankets may offer efficient solutions for improving thermal efficiency while minimising bulkiness. However, careful consideration must be given to compatibility with the modular construction of skiftesverk and its ability to accommodate movement and settling over time. The goal is to, by combining traditional craftsmanship with contemporary insulation solutions, to create a space that not only celebrates cultural heritage but also provides comfort, energy efficiency, and sustainability for visitors and occupants alike.



Post and planks is a skeletal construction of timber and is therefore a flexible construction method that is honest and understandable as a structure. The skeletal construction enables working with precision in details as well as being flexible in both outlining the floorpan but also changing the infill from a full timber construction into a half timber construction that still shows the honest skeletal timber structure.

Jönsson (2017) describes different methods to change the infill between the posts to solutions that cope with modern needs of insulation as well as how one could deal with the meetings of the infill and the post. The building products that he investigates, to see how they can be used to create a half timbered structure inspired from traditional post and plank structures, are industrially processed products. He wants to see if he can get this to become a conventional construction method again. His focus of investigation is in the joint between the timber posts and the insulation materials investigated since this is where the highest risk of leakage is.

I have investigated to use modern timber frames with insulation boards as the infill, since this is a popular way of building in Sweden today. To create a tight structure I have studied Jönsson (2017)s work and some reference projects. One reference project that has been a big inspiration is the Yomogidai House presented later in the thesis.

The problem that Jönsson (2017) identifies with skeletal structures with insulating infill is that they often are not airtight enough. The different materials move different during the seasons and that can create unwanted gaps in the structure. By creating grooves in the posts similar to the way they used to traditionally, the joint between the infill and the posts are allowed to move without exposing gaps.

Jönsson only investigates solution where the skeletal structure still is visible from both the inside and the outside. Yomogidai House instead uses a solution where some of the structure is hidden on the inside to provide for an even more airtight structure and to allow for more insulation but still keeping the essence of the skeletal structure and the slenderness of the post and planks original expression.

As seen in the section "Design Proposal - Naturum" in the detail cuts for the proposal of the naturum a combination of the solution used in the Yomogidai House and Jönssons investigations are used. To provide for a thicker insulation to ensure an energy efficient building, the structure is similar to the Yomogidai House in the way that the infill also goes around the posts on the inside moving away from Jönssons study. What is taken from Jönssons studies is the groove in the posts that ensures that there are no visible gaps emerging when the materials move. Still the essence and concept for the structure of the building is based around the visible skeletal structure reminiscent of post and planks or "skiftesverk" as the main loadbearing structure, and the infill acting as the climate shell, as visualised for the design proposal seen in the section "Design Proposal - Naturum".

This still allows for experimenting with meetings of the different structural elements that make the skeletal structure to develop the traditional building technique and to try and blend traditional Swedish craftsmanship with contemporary architectural principles.

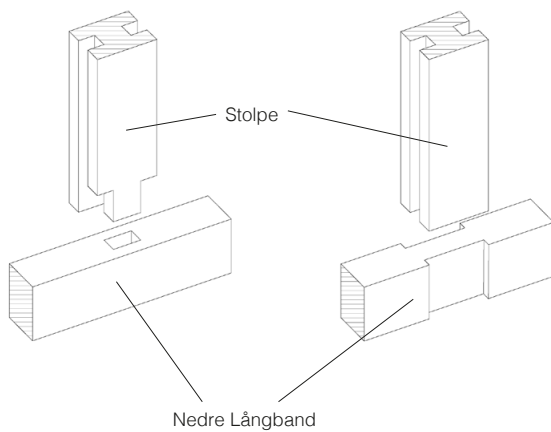
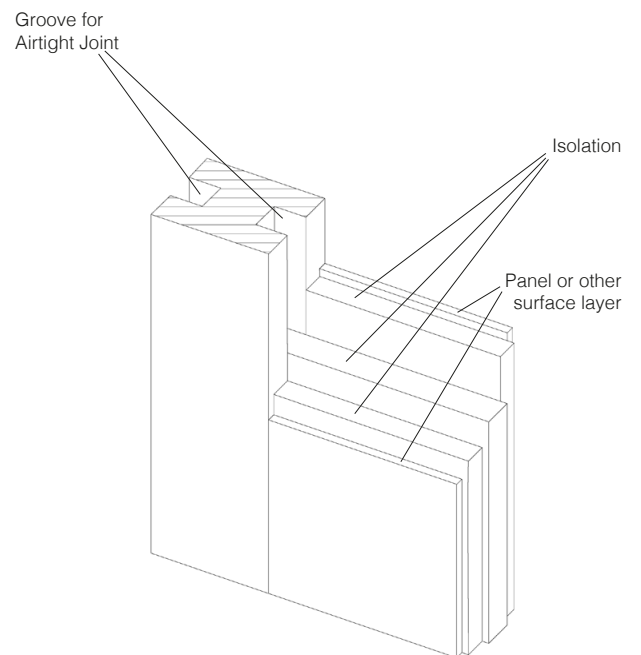
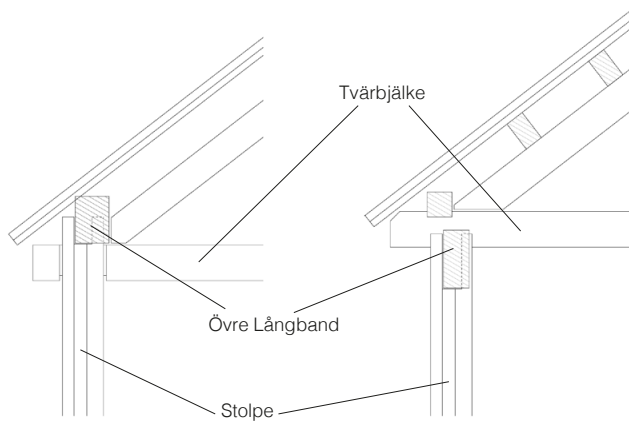
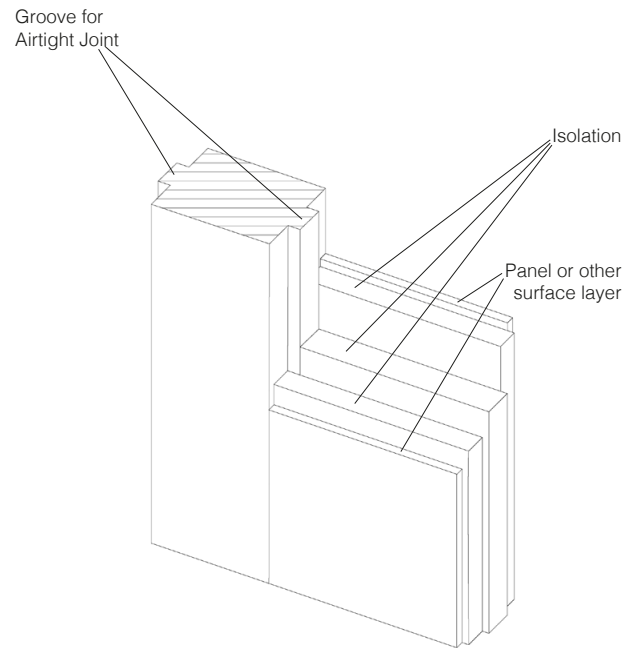
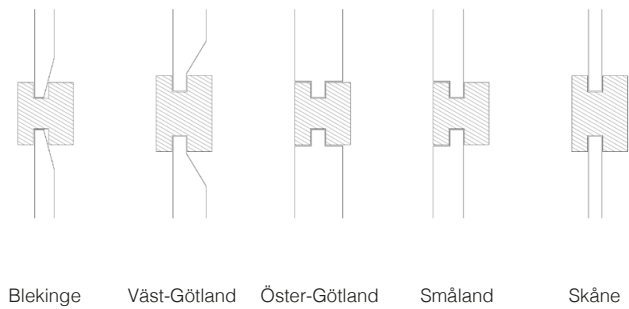

Plank and posts construction details [Illustrations], Inspired by Gunnar Henrikssons Illustrations, 1996, Skiftesverk i Sverige

Plank and posts construction details [Illustrations], Inspired by Johan Jönsson Illustrations, 2017, Metoder för att utforma fackfyllnadens möte med stolpen i ett halvnetat skelettverk



The name naturum comes from the Latin words domus naturarum that mean “house of nature” (Isitt, 2013). The word is today part of the Swedish dictionary with the definition “Premises with information concerning a natural area.”

The Swedish Naturum should, by architecture, inform people about nature and its history as well as increasing knowledge about the environment. As Ågren (2013) puts it architecture is a vital part of the experience and should therefore be of high quality, sustainably designed and accessible. That way our heritage develops and furthers our cultural history. A Naturum should not only inform about nature but should also inspire visitors to explore nature by themselves.

To use an already cultural valuable building typology as a starting point for this naturum only strengthen the development of our heritage. The Naturum will tell more than one story. Ågren (2013) also mention that the Swedish Government in 1998 drew up an action programme. The programme talks about being mindful of good architecture when making public buildings, creating qualitative architecture with a high environmental profile regarding materials and energy use.

Isitt (2013) tells an interesting story about how the idea of the naturum came to be. Carl Ekblad had visited North America and experienced the nature. Ekblad had been inspired by the architecture the Americans had in their national parks and thought that we should do something similar in Sweden, as quoted by Isitt (2013) “We have to lead people out. Inform them!”. The buildings in America were quite modest for the US. Some inspired by traditional outbuildings. Others more modern and adapted into the landscape.

The Swedish Environmental Protection Agency (EPA) decided they want to do something similar. They hope to make the general public more interested in nature conservancy by making national parks and reserves more know and accessible. To achieve this they wanted to create buildings similar to museums.

The first official naturum visitor centre was opened 1974 in an old barn in the traditional red colour “Faluröd” (Isitt, 2013). Another exhibition was opened a year later in a similar building. The reason then to use the old traditional buildings was due to economical reasons. These first naturum were not as successful as they had hoped for. They felt dusty and old and where not inspiring.

Instead they made an effort to create new buildings that should be more inspiring than the first attempts. But in contrast to the approach in the US where a style has been develop specifically for this type of building they have let a few of Sweden’s best architects do what they are best at and trusted their ability to read the site. Reading the conditions,

directions, winds, light, sound, soil, topography and so on. In most cases are exhibitions, architecture and nature working in symbiosis and manage to inspire visitors to explore nature by themselves. The first naturum that does this is naturum Hornborgasjön that was opened 1986. This project formed the fundamental principles that most of the following naturum would follow. These rules were followed by many naturum to come. As quoted by Isitt (2013):

“The building must be specific to the place. The Hornborgasjön naturum, for example, has a reed-thatched roof (hard to justify in a place where reeds don’t grow). Slender duck boards extend over the wetlands, leading the visitor far out among the ever-laughing black-headed gulls, putting them in close touch with an environment they would otherwise never have access to. This is not to say that only local materials are accepted or that the architecture must take its cue from the surroundings. When it comes to communicating the wonders of nature, all architectural expedients are permissible - well, nearly all.

A naturum is a building presenting ecology, but not necessarily an ecological building. The building’s ecological footprint must of course be the smallest possible, but what you have awaiting you out there among the reeds is not a passive building, not so well-insulated that if you unlace your hiking boots in October it will stay warm well into next spring. That would impose too much constraint on the language of architecture and would frustrate the main purpose of the building, which is to convey the qualities of nature.

The architecture must be contemporary. Even if the brief presupposes protection of the site, this does not mean that the building must be camouflaged and the architect must fall back on mimicking nature. On the contrary, the building must be seen, must confidently take its place in the setting, communicate clearly and distinctly as a landmark and in this way articulate the beauty of its surroundings. This is man working with nature instead of against it.”

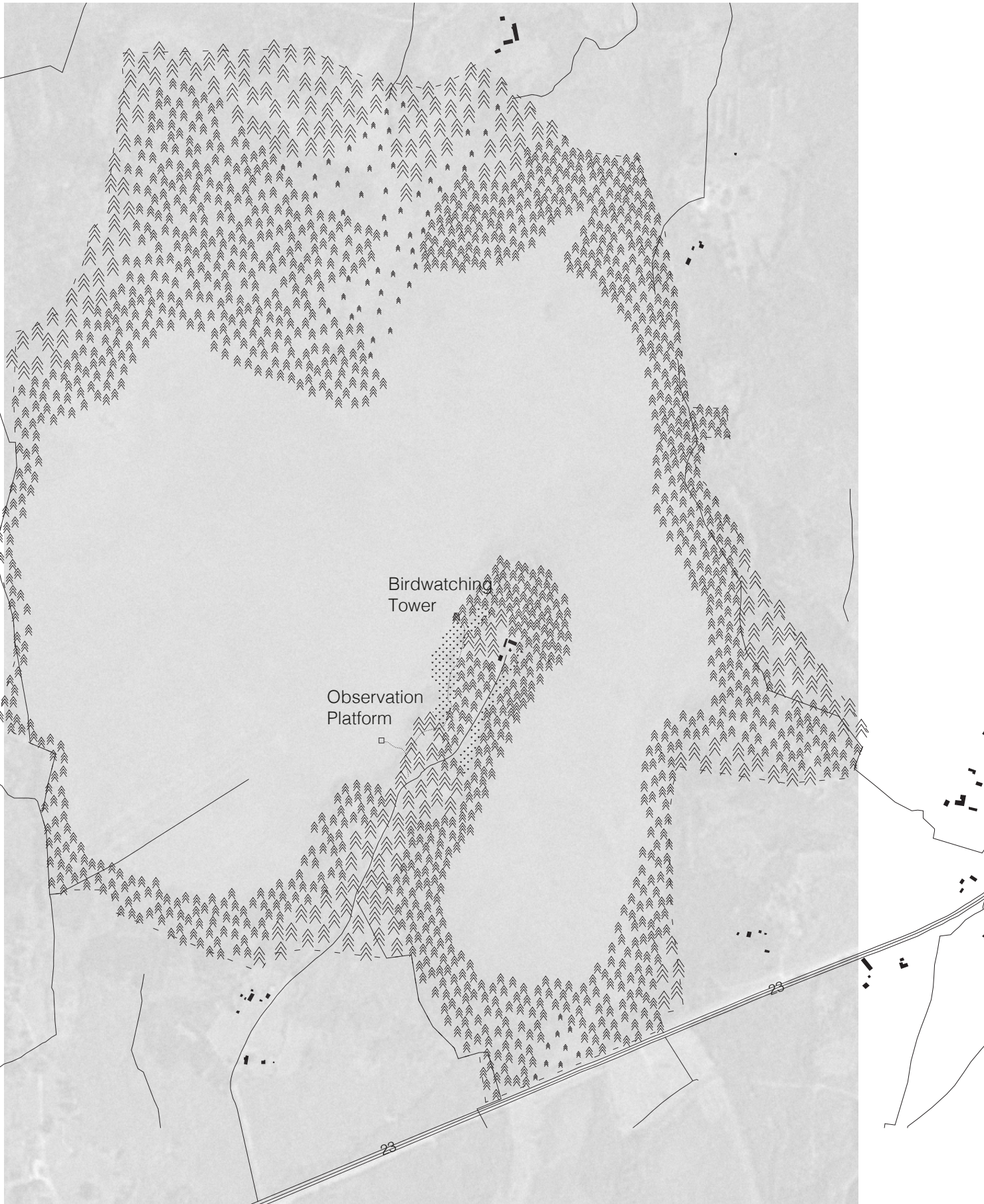

Existing Site Plan 1:10000

The site is Taglamyren nature reserve located in central Kronoberg county in Småland. The reserve is a widespread bog and marshland surrounded by both young and old forest. The fen has not been harmed from turf-cutting or ditching and is therefore a popular space for birds to breed and for a large variation of vegetation.

Taglamyren is important for bird life. When it is breeding season birdwatchers visit the reserve to see the variety of species. There is a accessible platform and, after a short walk, a birdwatching tower where one for example can see Golden Plovers breed and Black Grouse play their sounds in the spring.

The short walk to the birdwatching tower takes one through many different types of nature. Following the path one goes through old and young forest, wetlands and one can during the walk always get a glimpse of the widespread landscape. The vegetation in the nature reserve exist of Dwarf birch, cattail, marsh lily, sileshair and bell heather. The existing path is for the most part on the headland of moraine that heads out in the centre of the bog. Here there is also a homestead with farmland surrounding it that need to be taking in consideration if making changes to the path and locations of the buildings. When walking on the path one also has to walk together with the cows for some small stretches.

Going in the other direction the terrain becomes a bit less accessible, but it is still a clear path. One has to go through a gate and enters a part with older forests with wetland. The forest then passes into farm land joining the cows. The last part before arriving to the birdwatching tower that is at the end of the path, one goes over a wetland with the younger small birches. The path is made out of planks and small bridges that start to feel old. From the observation tower one has a good view over the landscape, but one also wonders what is visible if one could walk further.

The site is located close to where I grew up and I therefore feel a connection to the site and the nature. The beautiful widespread landscape and untouched nature is something that should be more accessible to visit. Taglamyren nature reserve is a bit anonymous and I believe that the reserve would benefit from a uplift in form of a naturum or something similar. I also believe that nature tourism will grow even more. Others than outdoor people want to get out and explore. Furthermore there are multiple schools in relative close proximity. They could use a facility at a place like this where kids and youths can learn about nature and sustainability trough doing school outings.

One does not realise they enter the nature reserve until one arrives at the parking lot that is located about 1 kilometers from the larger road 23. Directly from the parking lot the landscape starts to open up. The only other clue that it is a nature reserve, except for to beautiful wide spread landscape, is the simple information board at the beginning of the path.

The path is located quite logical, away from the road, towards the larger open spaces and not intruding on the landscape or the neighbouring homestead.

When taking a left turn in the beginning of the path there is a platform that is accessible for wheelchairs. It sort of lurks behind the small birch trees and lays a bit out into the open landscape giving it an almost 360° degree view of the widespread bog.

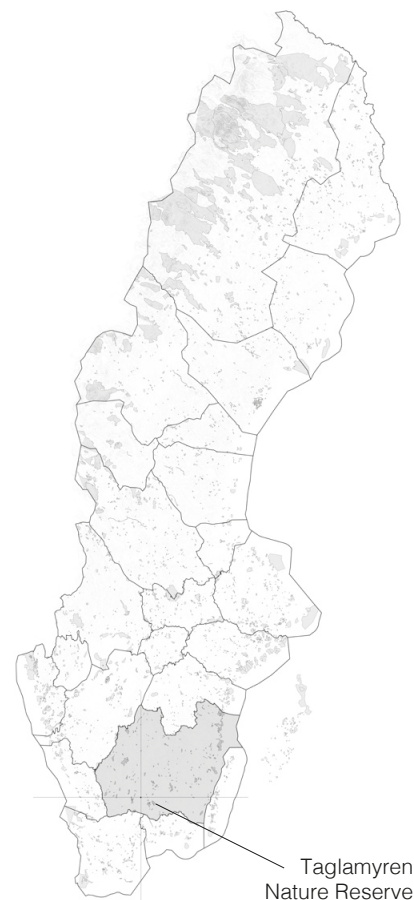





Naturum Store Mosse | White Architects

Naturum Stora Mosse is a strong example of a modern naturum visitor centre that seamlessly integrates with its natural surroundings while drawing inspiration from traditional Swedish timber construction.

The design of Naturum Stora Mosse prioritizes a fluid and intuitive flow, guiding visitors through the space in a seamless manner. This allows for easy exploration of the various exhibits and amenities while maintaining a strong connection to the surrounding landscape. The large window at the end of the building frames the view out on the open landscape. Framing the views will be an important part for my buildings and naturum stora mosse will be a good example of how it could be done.

The visitor centre serves as a multifunctional space, accommodating a range of activities and programs aimed at educating and engaging visitors with the natural environment. From interactive exhibits to educational workshops, the program is carefully tailored to meet the diverse needs of visitors. This naturum is on a bigger scale than what mine will be, but it still will give inspiration to my project. I could use different functions and try to combine them to accommodate more scenarios such as digital exhibitions en educational workshops.

Drawing inspiration from traditional Swedish timber construction the design is echoing the vernacular architecture of the region. This nod to tradition adds a sense of authenticity and cultural relevance to the modern interpretation of the visitor centre. This is in line with the goal of my thesis, but in a more subtle way than what I am hoping to achieve.



Interior and Exterior of Naturum Store Mosse [Photograph],
by Mikael Olsson, (n.d), White

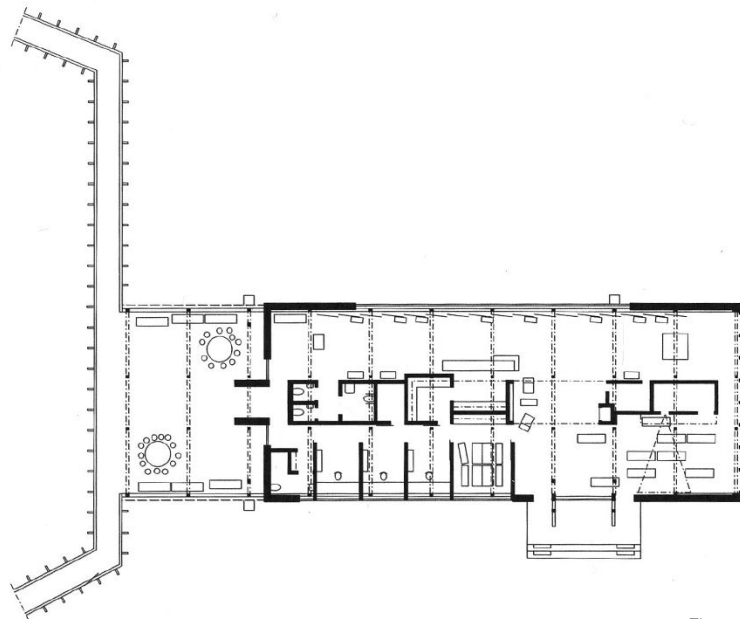

Floorplan [Drawing], by White, 2003, White

Yomogidai House | Tomoaki Uno Architects

The Yomogidai House showcases a seamless blend of modern architectural principles with traditional Japanese craftsmanship. It is a contemporary residential design that seamlessly integrates with its surroundings, embodying a harmonious fusion of modernity and traditional elements.

The design prioritizes a fluid circulation pattern, guiding occupants through the space effortlessly. This aspect ensures a seamless connection between indoor and outdoor areas, enhancing the overall experience of the environment. The varying volumes and ceiling heights within the structure add visual interest and create distinct spatial experiences. From intimate, cosy nooks to expansive, airy areas, the design offers a range of environments to suit different needs and preferences. The structure of the program is simple, but strong and makes the experience of the space easy to understand. This seamless flow of connections between the rooms as well as with the inside and the buildings surrounding is something that I would like to achieve in a similar manner with my naturum. The difference in ceiling height can also be used to define different hierarchy between spaces.

Attention to detail is evident throughout the Yomogidai house, with precise craftsmanship showcased in every aspect of the design. From intricate joinery to thoughtful material selection, the detailing elevates the overall aesthetic and functionality of the space. The simplistic design creates a calm and beautiful space. This makes the attention to detail extra important. To bring my buildings into today and to elevate the traditional Swedish timber structures I will have to pay the same type of attention to detail when designing my buildings.

The wall construction combines modern techniques with traditional materials, resulting in a structure that is both durable and visually appealing. This integration of old and new methods adds depth and character to the architecture. Studying the construction of the wall in this building has given me strategies that can be used in the naturum as well since the overall structure is similar to the Swedish post and plank structure.

The strategic placement of windows allows for abundant natural light and stunning views of the surrounding landscape. These openings not only frame the scenery but also invite the outdoors in, fostering a strong connection to nature.

Wood plays a central role in the design, with its warm tones and natural textures creating a welcoming atmosphere. The craftsmanship of the woodwork adds a sense of authenticity and craftsmanship to the space, further enhancing its charm.

The Yomogidai house lays as a horizontal line in its surroundings which creates an impactful presence on the plot. This could be an interesting concept to bring into my project, working with both horizontal and vertical lines creating strong elements in the otherwise calm surroundings.



Interior and Exterior of Yomogidai House [Photograph], by Ben Hosking, (n.d), Arch Daily

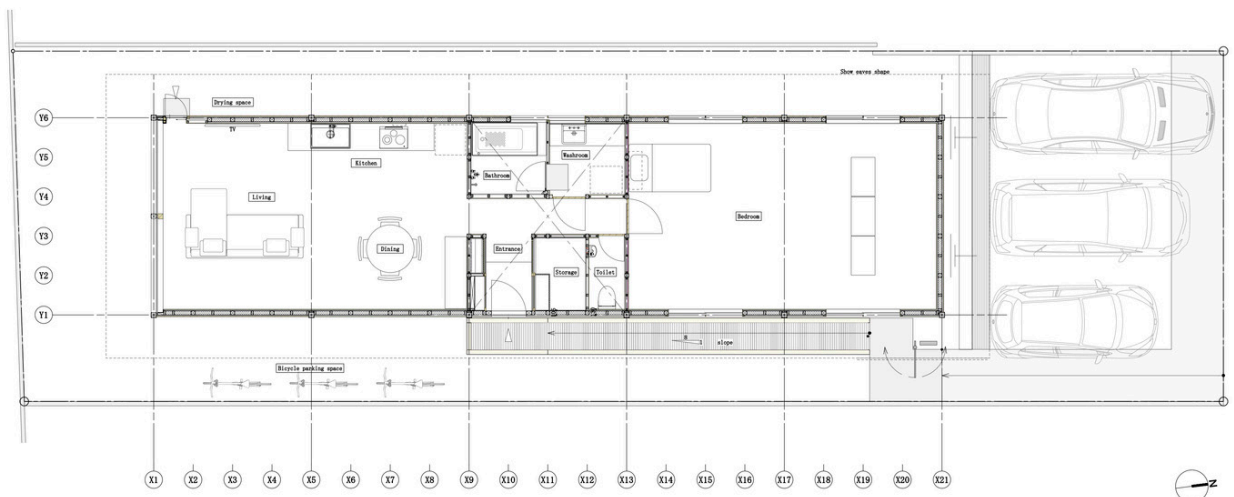

Floorplan [Drawing], by Tomoaki Uno Architects, 2018, Arch Daily

Antbrufossen Vannbruksmuseum | L J B

The Antbrufossen Vannbruksmuseum is a notable example of a museum that successfully integrates with its natural surroundings while offering a rich program and meticulous attention to detail.

The program of Antbrufossen Vannbruksmuseum bears resemblance to my project, focusing on providing visitors with an immersive experience that educates and engages them with the natural environment. This similarity will serve as a valuable reference point for designing this naturum visitor centre. The design incorporates open spaces for exhibitions, allowing for flexible layouts and the display of various pieces and exhibition material. This opens for exploration and discovery among visitors.

A strong emphasis is placed on connecting the indoor spaces with the surrounding outdoor environment. This seamless integration blurs the boundaries between inside and outside, enhancing the overall experience and encouraging interaction with nature.

Amenities such as toilets are made accessible even when the exhibition is closed, ensuring convenience and comfort for visitors at all times. This thoughtful approach to design enhances the visitor experience and is something to bring to my project as a solution to not have to create a service house or such on the site.

Woodwork plays a significant role in the design, with meticulous attention to detail evident throughout the structure. The structure of Antbrufossen Vannbruksmuseum is similar in its base as post and planks and many solutions that are used can be adapted for the naturum in Taglamyren. The project also demonstrates a sophisticated approach to lighting design, with careful consideration given to both natural and artificial lighting. This creates a welcoming atmosphere and highlights key features of the exhibition, enhancing the overall ambiance of the space.

The visitor centre is well integrated into its surroundings, with the architecture complementing the natural landscape rather than overpowering it. This harmonious relationship with the environment enhances the overall aesthetic appeal and sustainability of the project.



Interior and Extiroid of Atnbrufossen Vannbruksmuseum [Photograph], by Marchesi, Hellum & Stikbakke, (n.d), Arch Daily

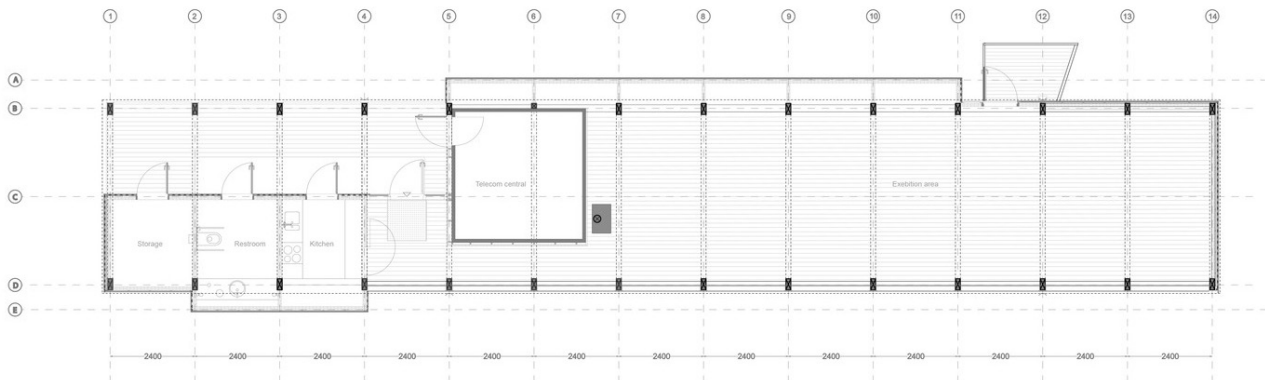

Floorplan [Drawing], by Marchesi, Hellum & Stikbakke, 2013, Arch Daily

Periscope Tower | OOPEAA

The Periscope Tower stands as a testament to innovative design and seamless integration with the natural environment, providing visitors with a unique and immersive viewing experience.

The openings of the tower are carefully selected that artfully guide the views of visitors, framing specific points of interest within the landscape. This deliberate design enhances the visitor experience by offering captivating vistas and focal points.

At the heart of the tower lies a central solid core surrounded by a half transparent structure. The central core of the tower acts as a periscope. This architectural concept offers visitors dynamic perspectives of the surrounding landscape, creating an engaging and memorable experience. The concept of the solid central core and the half open structure surrounding it could be played with to create a tower that also gives protection as well as providing a dynamic and engaging way of guiding the visitors to the views.

As a vertical element in the landscape, the tower harmonizes with its surroundings, complementing the natural beauty of the environment. Its sleek silhouette adds visual interest and serves as a striking focal point in the landscape.

The tower is strategically placed to maximize views of the surrounding landscape, ensuring that visitors can fully appreciate the beauty of their surroundings. This thoughtful placement enhances the overall visitor experience and encourages exploration.

By emphasizing the importance of detail and craftsmanship in the design of the birdwatching tower, drawing upon classical Swedish timber techniques. Letting the natural beauty of the wood speak for itself, the atmosphere is warm and inviting for visitors to enjoy their birdwatching experience.

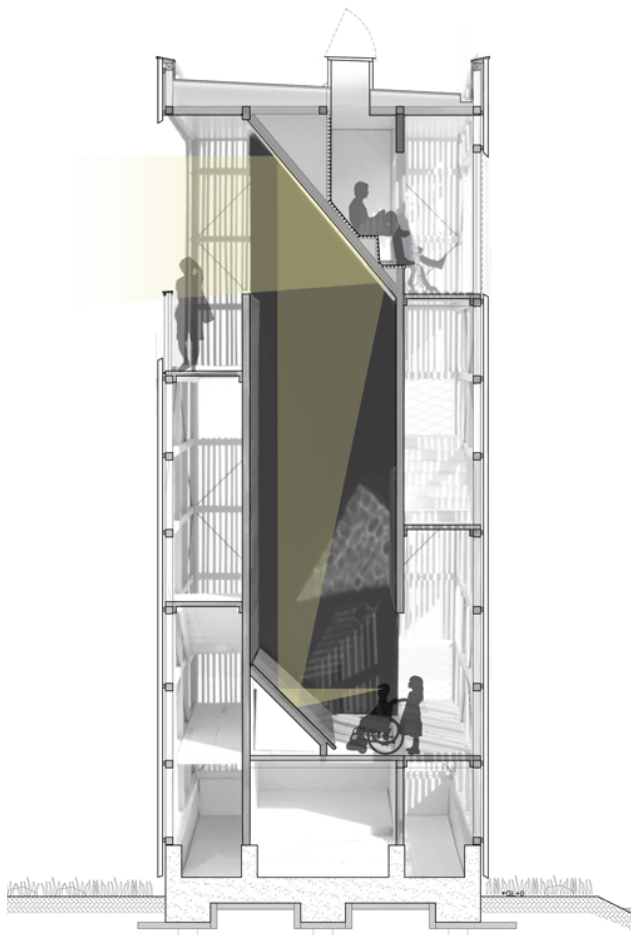

Perspective Section of Periscope Tower [Drawing], by OOPEAA, (n.d), OOPEAA

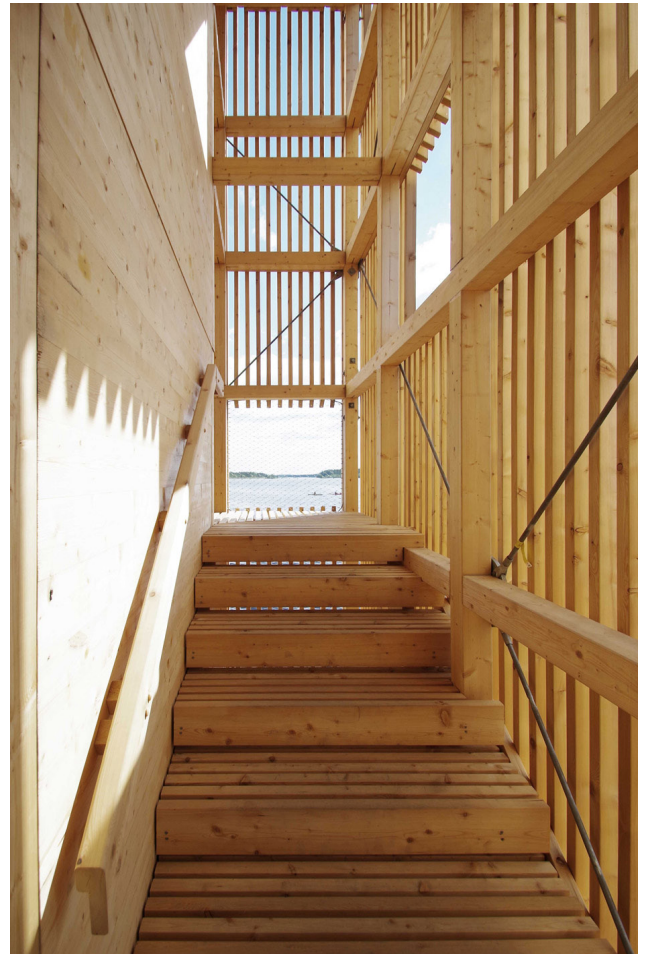

Interior and Exterior of Periscope Tower [Photograph], by Unknown, (n.d), OOPEAA

The program is in one sense more than only for one building. For the naturum the space program is not that big, but with a lot of possibilities. And the complementary birdwatching tower has its primary function. But the site could be part of the design. The buildings together with the path(s) and nature should work in symbiosis to tell a story.

The existing path at the site works well. It does not intrude on the open space or on the surrounding buildings. Also, it goes through most types of nature that exist in the reserve so that visitors can see all types of vegetation. The path follows nature and creates beautiful moments. But it would also benefit from a bit of care taking to elevate the experience. To create more impact, not only the new naturum should be well designed, but also the path. Designing the duck boards and bridges to frame nature would give the journey an extra layer.

The existing way to approach the site is natural, with easy access from the larger road 23 and the parking lot centrally located in the reserve. The walk to the existing birdwatching tower is today a bit short for short hikes. By lengthening the walk and moving the location for the new birdwatching tower up north in the reserve both lengthen the walk and create better opportunities to take use of all the views. This action would still not bother the surrounding houses and would make a better "journey" possible. The location of the naturum should be close to the

parking lot to create a start of the story that the visit of the reserve should create. Therefore to reuse the location of the existing location of the observation platform for the naturum feels natural.

The naturum is based around a semi-outdoor space. The different functions of the building will be accessed from this space. The indoor spaces consist of the main exhibition together with a smaller space with the primary function being a digital exhibition but that also can act as a lecture room or a space for workshops. On the other side of the central part of the building is a café with an area for staff, storage and the technical functions of the building as well as toilets that can be accessed from the outside even when the rest of the building is closed. From the café visitors can access an outside deck via the semi-outdoor space.

The birdwatching tower will be the end destination of the narrative. It will contain a combination of an observation tower and a place to rest and be sheltered from weather and wind.

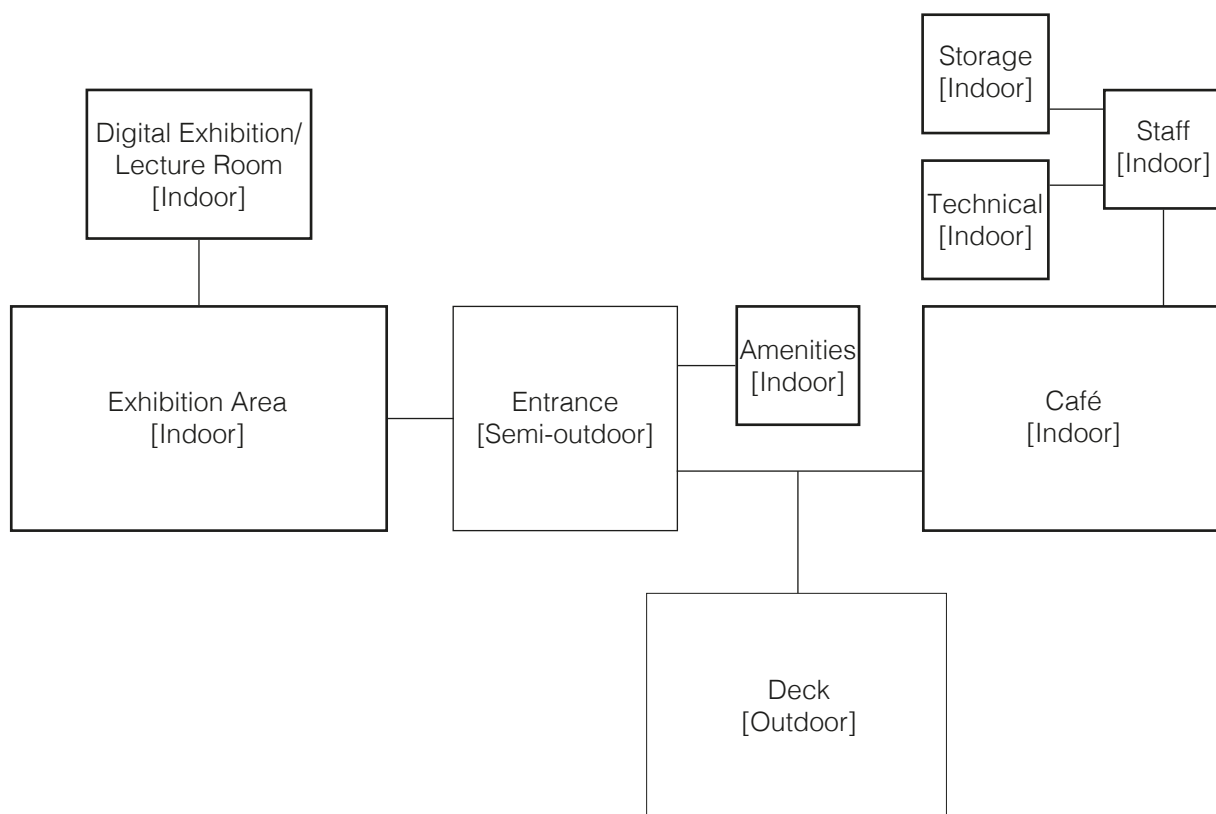

Schematic program of naturum

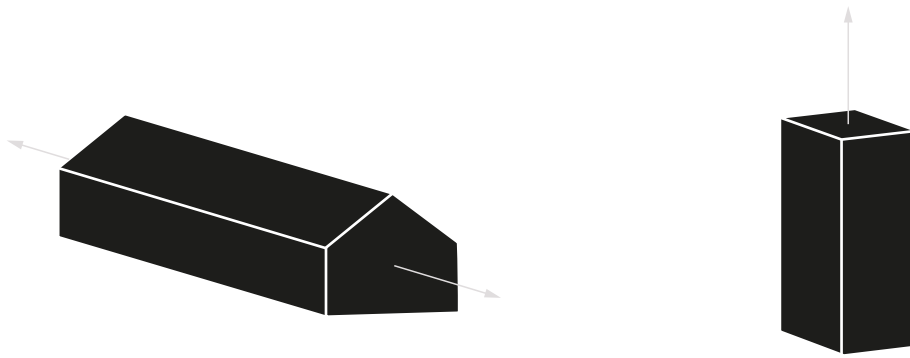

Line in the Landscape

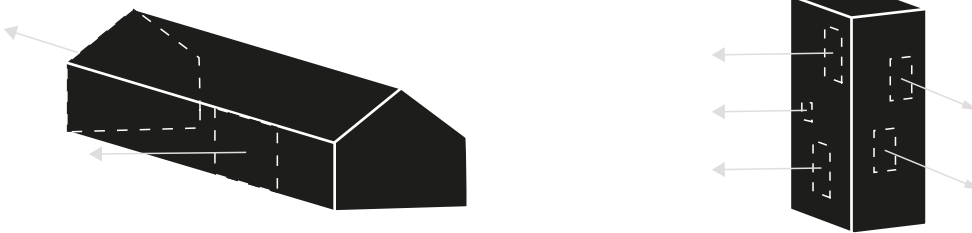

Orchestrate the Views

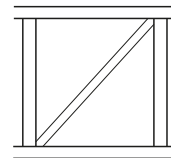
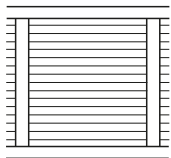

Interpretation of Traditional Woodwork

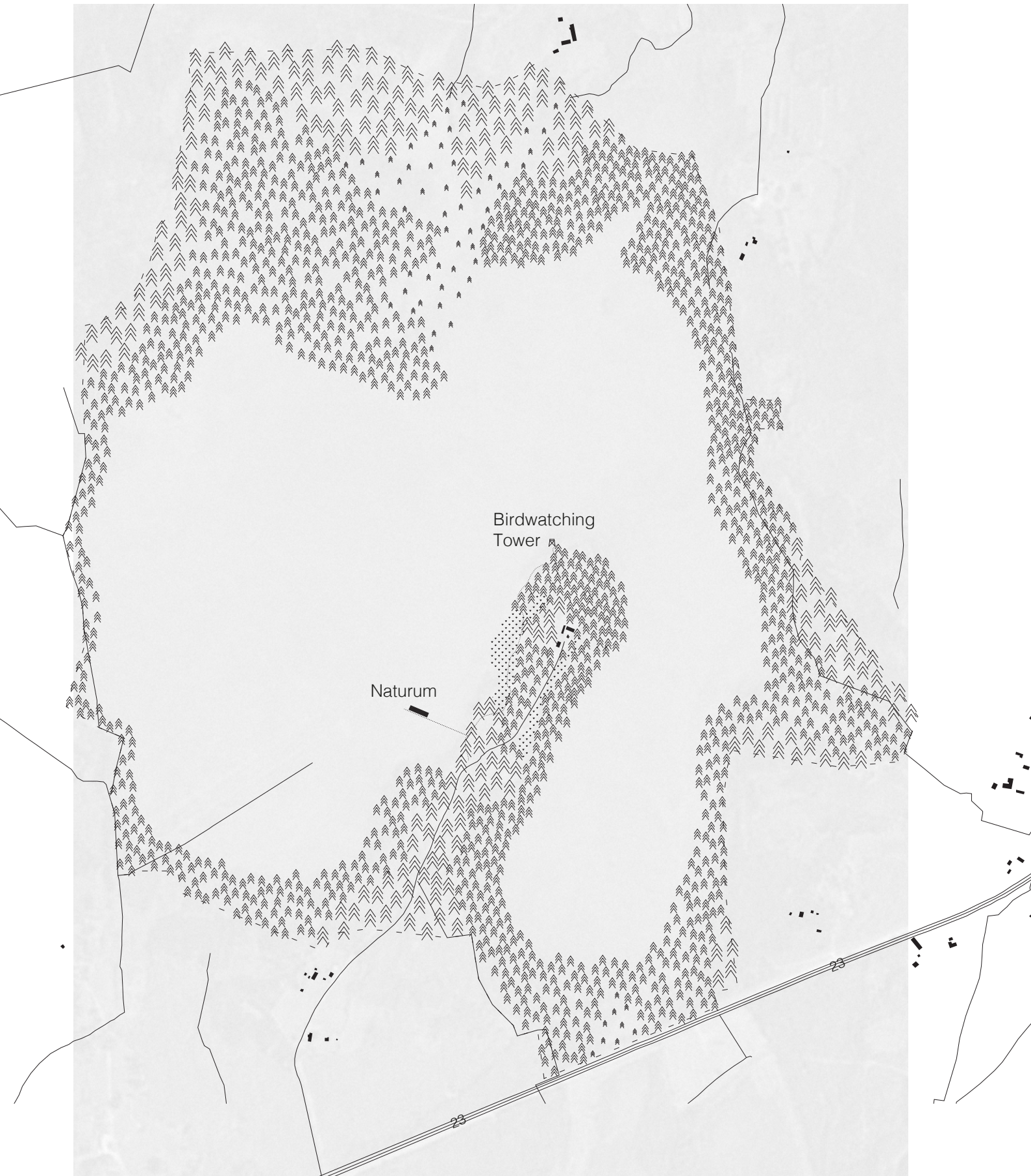

New Site Plan 1:10000

Nature Reserve | Concept

The main idea centres around a narrative that seamlessly integrates with the essence of Taglamyren Nature Reserve. Through architecture, the aim is to inspire visitors to explore the beauty of the bog themselves, with the naturum serving as the focal point of this narrative as the origin of its name suggests, "the house of nature", the naturum should offer insights into the rich variety of the reserves flora and fauna as well as informing about the timber building traditions, inspiring visitors to explore the reserve themselves.

At the end of the path lies the birdwatching tower, a symbolic destination marking the summit of the experience. The birdwatching tower makes it possible to take in the Taglamyren from a different perspective, from above.

The project aims to create a more attractive place to visit to a diverse range of visitors, from experienced birdwatchers to those less accustomed to getting out in nature. By strategically placing duck boards and architectural elements, the experience for the visitor gets enhanced, ensuring that everyone can enjoy the reserves beauty, including individuals with disabilities.

Importantly, the interventions are designed to minimize disruption to both the environment and nearby residential houses. By making subtle adjustments to the path and relocating structures thoughtfully, we maintain the delicate balance that is there today. The naturum is placed at the same place where the observation platform is located today out in the open landscape, similar to how meadow barns were placed back in the day. The birdwatching tower is placed about 200 meters up north to open up the views as well as to extend the path and the experience.

Central to the design philosophy is the synergy between architecture and landscape. The naturum, with its horizontal design reminiscent of traditional timber buildings, blends with the surroundings, while the birdwatching tower stands tall as a vertical landmark, guiding visitors towards the journey's end.

Conclusively, with the concept the aim is to with reimagined traditional Swedish timber architecture invite more people out to nature and Taglamyren Nature Reserve to explore and learn about nature by creating an accessible and attractive experience.



Naturum | Concept

The main building of the project is the naturum that is located a short walk from the parking lot. As a visitor, one can already from the parking lot get a glimpse of the naturum that lays as a horizontal line in the landscape. You walk on the duck board in a straight line over the widespread bog to get to the building that lays about a 100 meters out in the landscape. The duck board stretches past the naturum out into the open landscape with an small observation platform at the end, inviting to stand still and take in the landscape without entering the building.

As the main part of the project the naturum challenges the concept of "skiftesverk", trying to develop the traditional building technique into a modern version that both mirrors the past but also enables the more everyday functions and modern days requirements and need of construction and insulation. By refining the meetings of the main skeletal timber structure creating a construction that is easier on the eyes that highlights the wood in combination with exchanging the planks that closed the structure with a more modern structure forming the climate shell and ensures a well insulated structure.

The first space that a visitor meets when arriving to the naturum is a semi-outdoor space acting as an entrance to the whole building, where the rest of

the functions are based around of. From the space, protected with only a roof, one can reach both the main exhibition, toilets, a café and an large deck to the south in the sun where visitors can enjoy their coffee or just the view. In the main exhibition space there is also a smaller space for digital exhibitions, lectures and small workshops. In the main exhibition space there are different possibilities to display things an also a integrated bookshelf with seating. Connected to the cafe is also the staff room, storage and a room for technical functions. The toilets are directly connected to the semi-outdoor space so they can be reached even when the rest of the building is closed.

By strategically placing the windows, the building takes advantage and orchestrate the views in a clear way. The main window concept is the large opening at the end of the building framing the big view out to the open landscape. The cafe is placed towards to south to enable taking advantage of the sunlight. The rest of the windows in the building are placed only to let in daylight into the different spaces of the building. On the facade towards the south, inspiration from the gaps that are formed due to shrinkage of the wood on old post and planks buildings, as seen in the picture beneath, has been taken by having windows up high on the facade only to let in light.



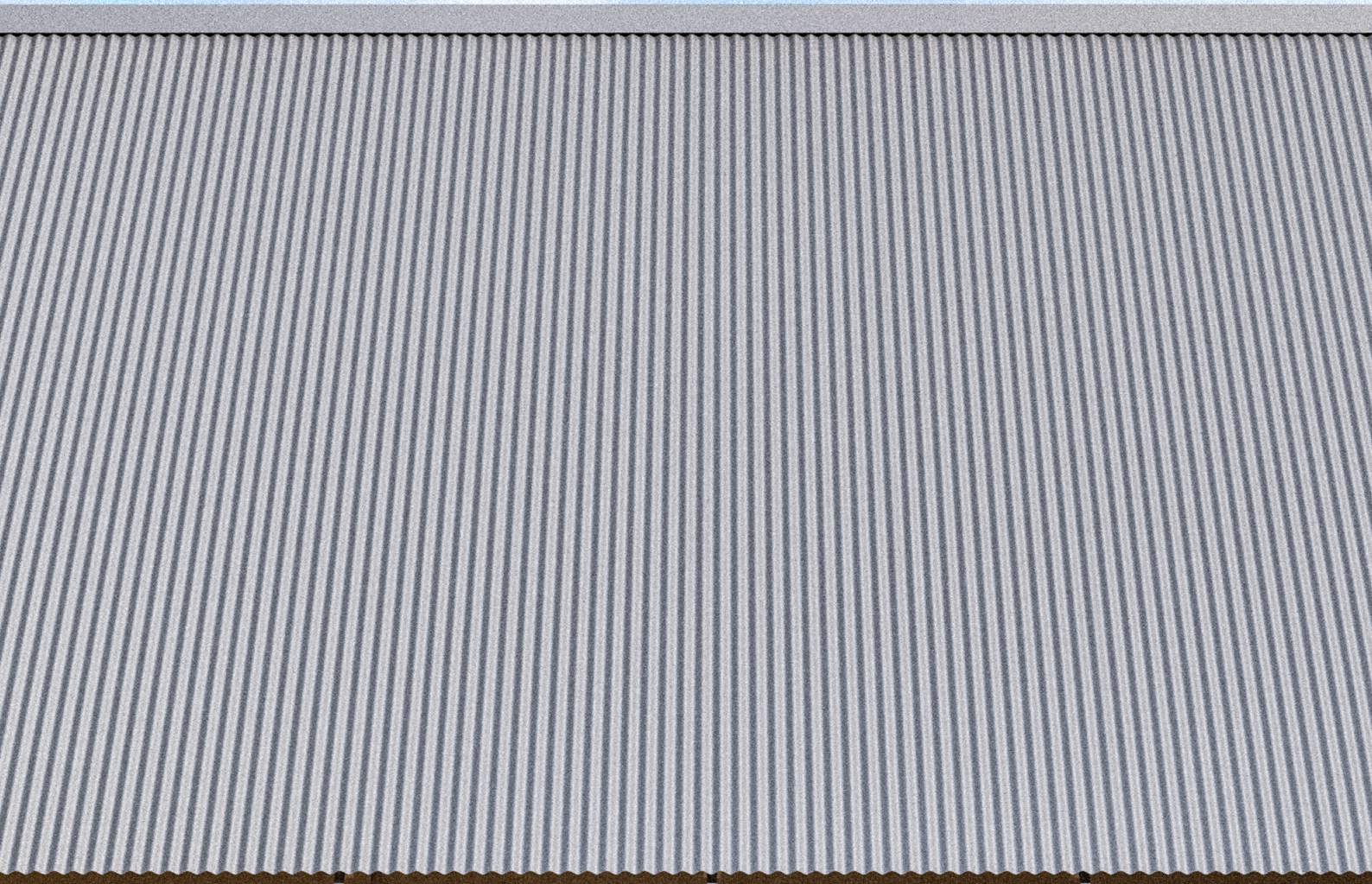

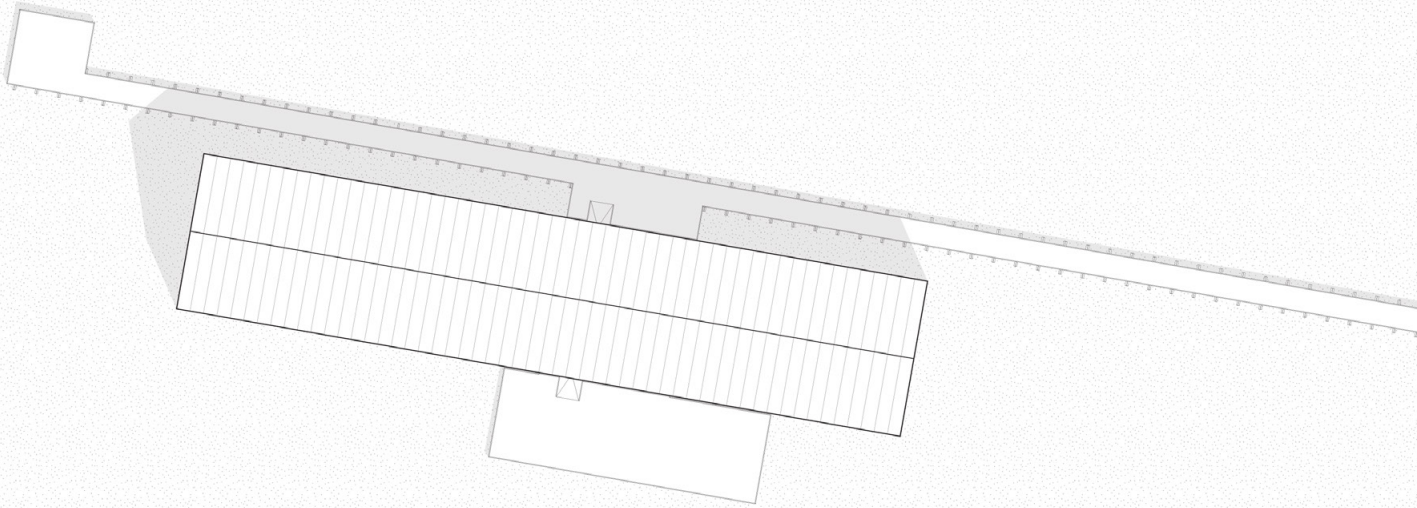

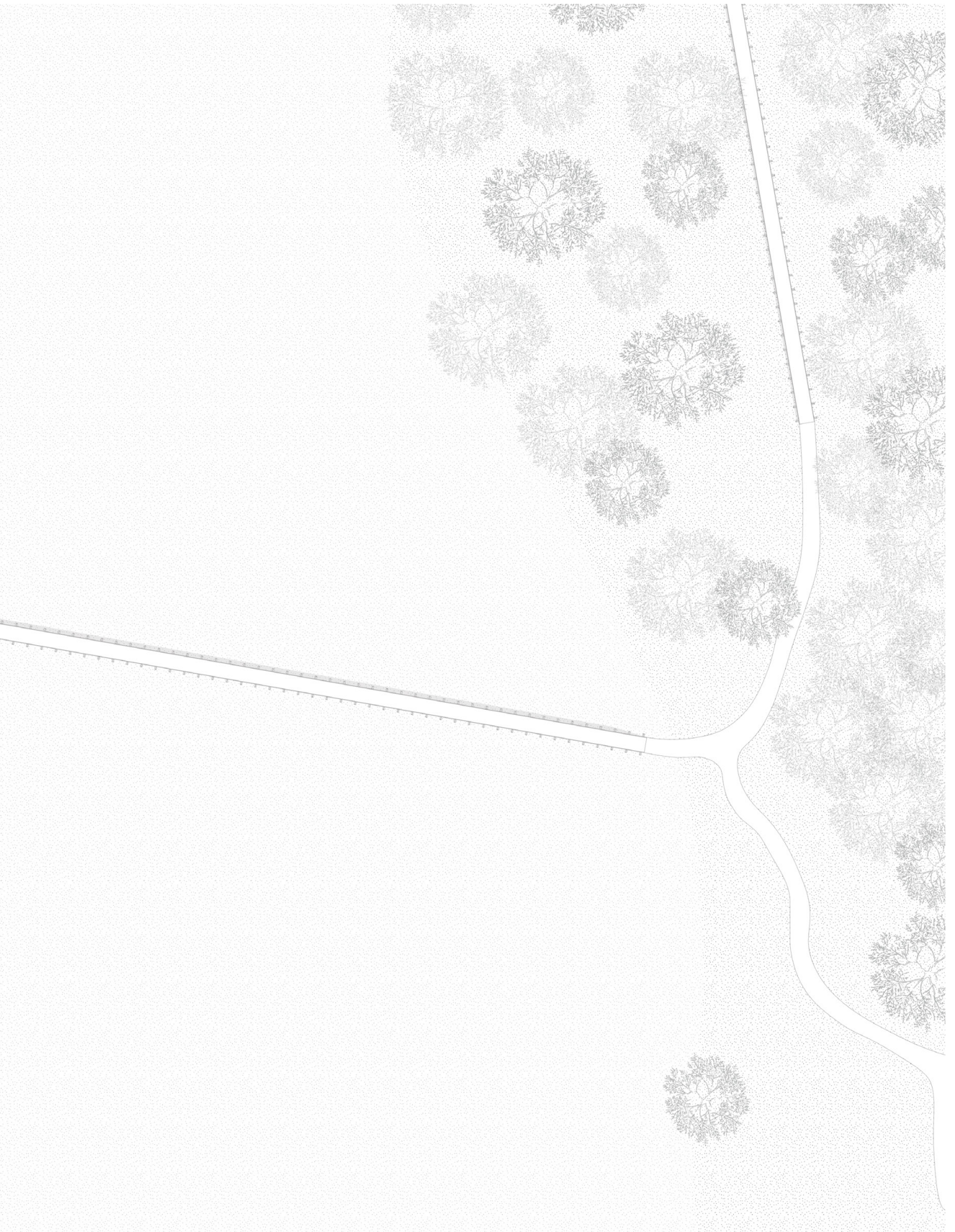

Site Plan 1:2500

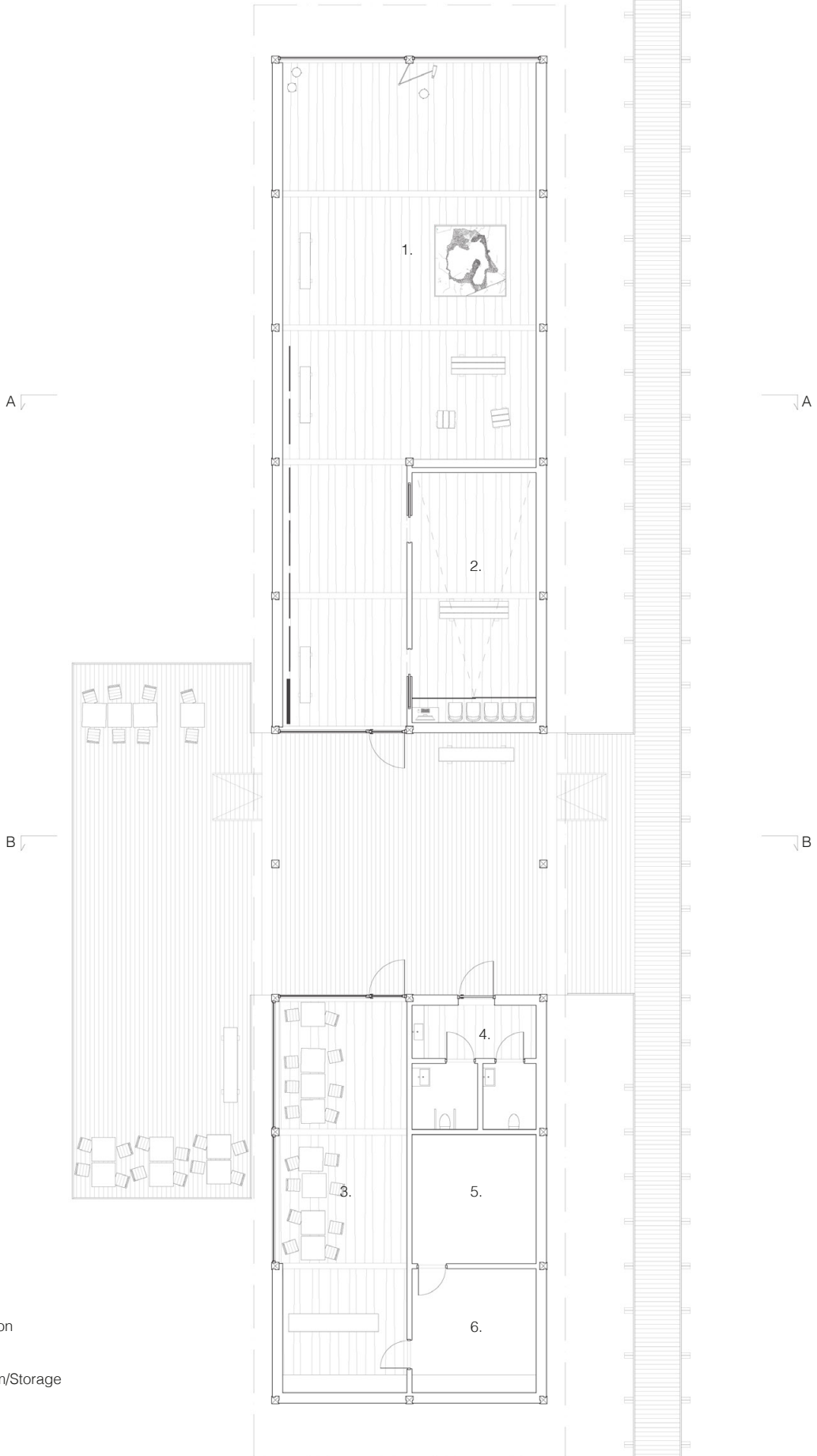

- 1. Exhibition
- 2. Digital exhibition
- 3. Cafe
- 4. Toilets
- 5. Technical room/Storage
- 6. Staff/Storage

Floor Plan 1:200



South

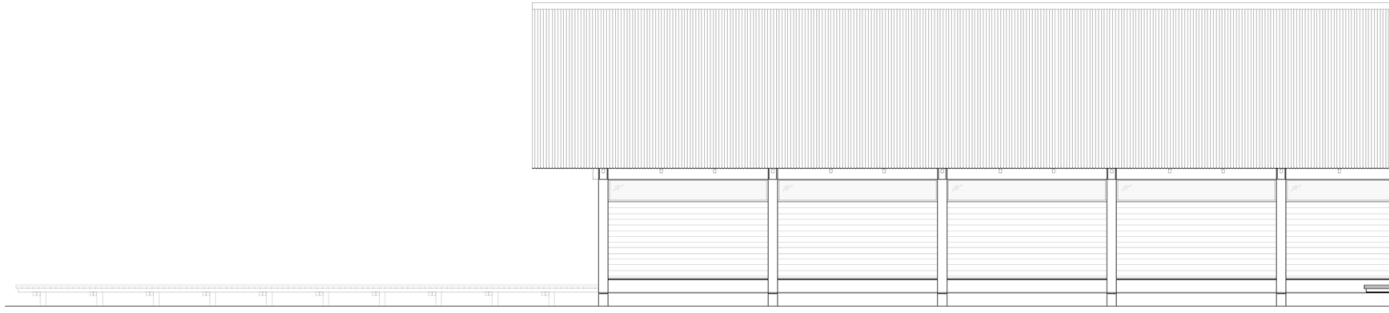

East

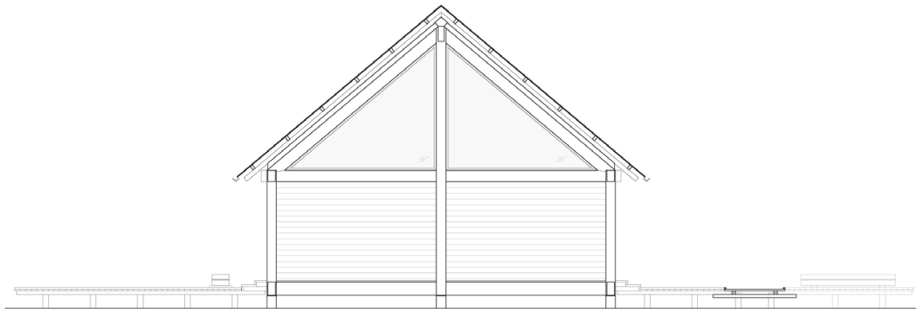

North

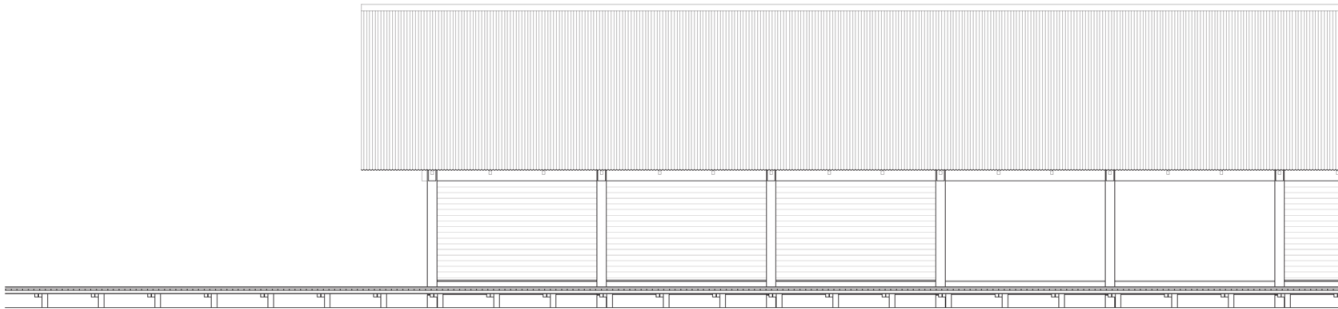

West

Elevations 1:200

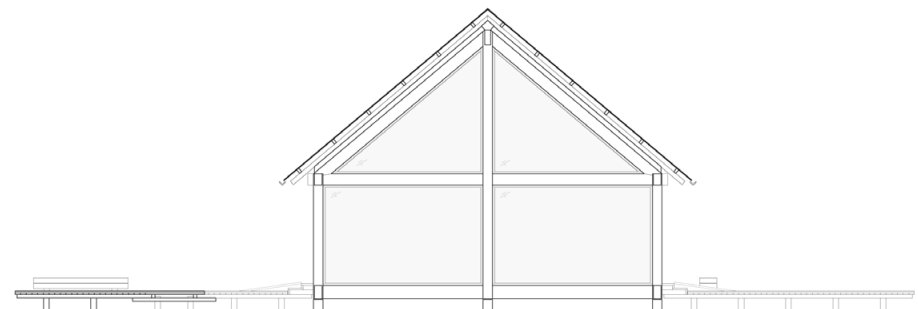
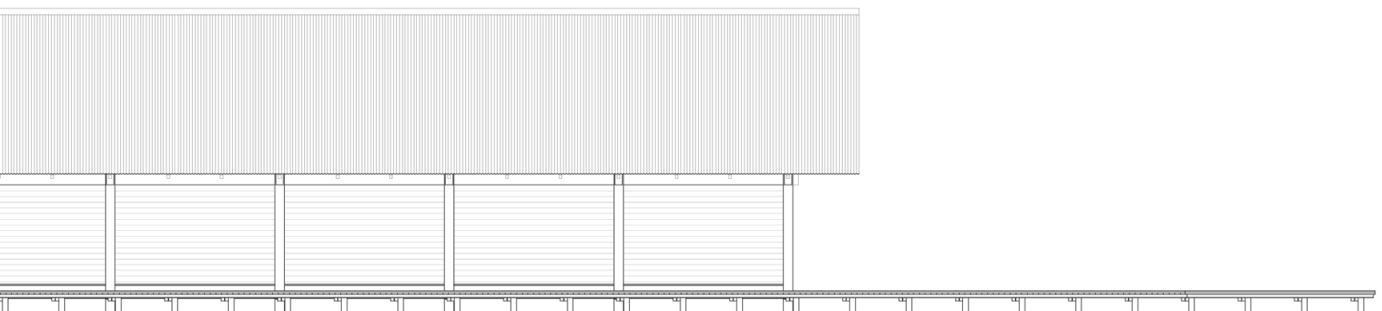
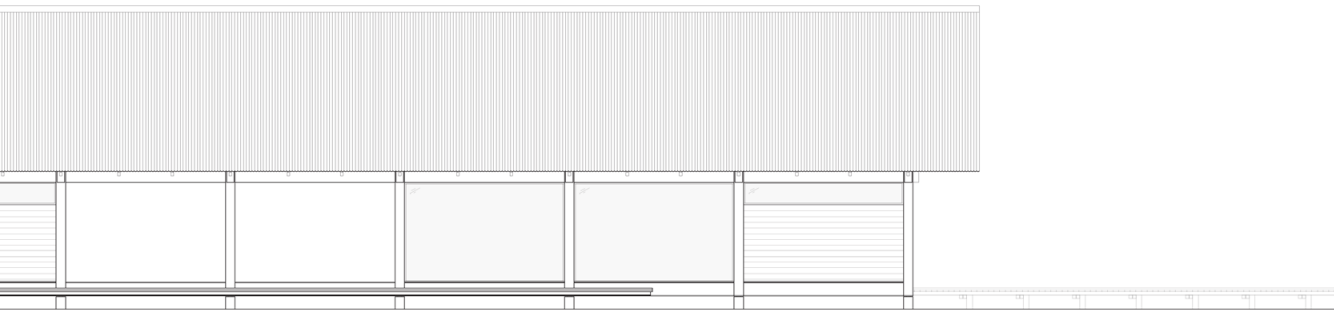

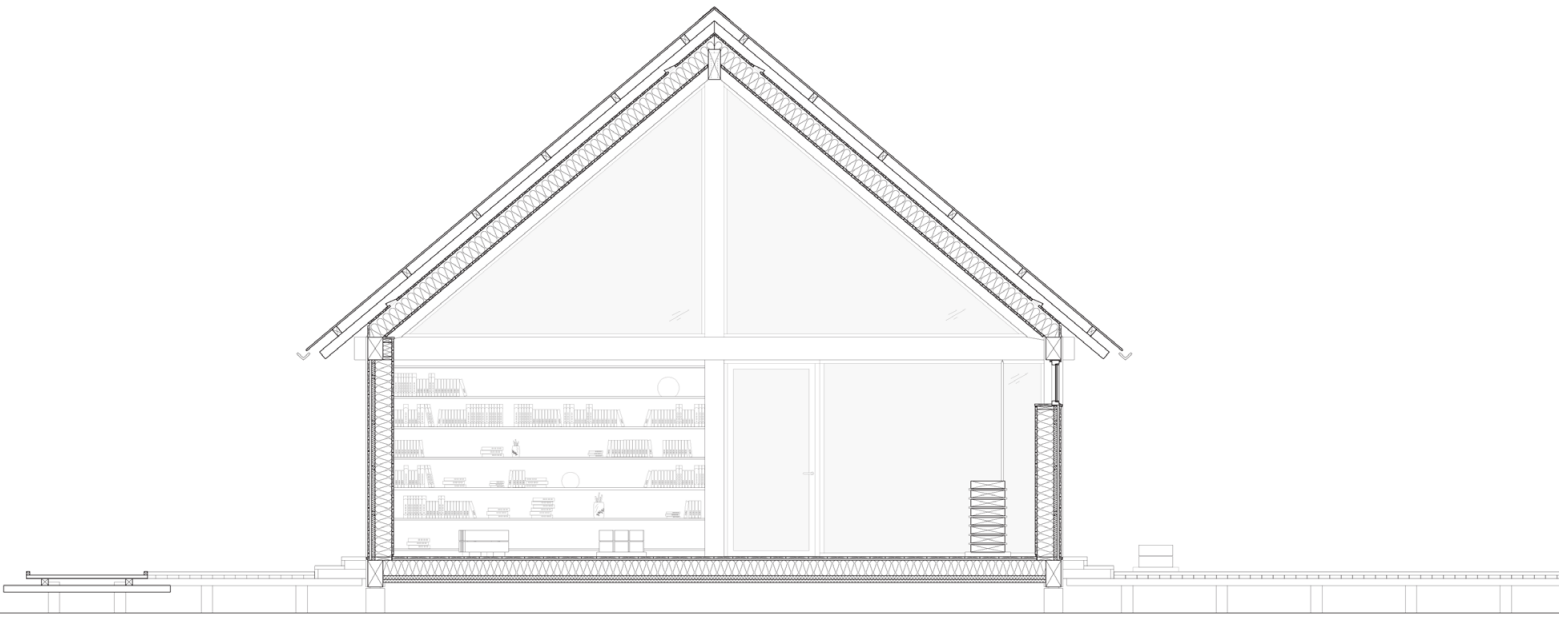

A-A

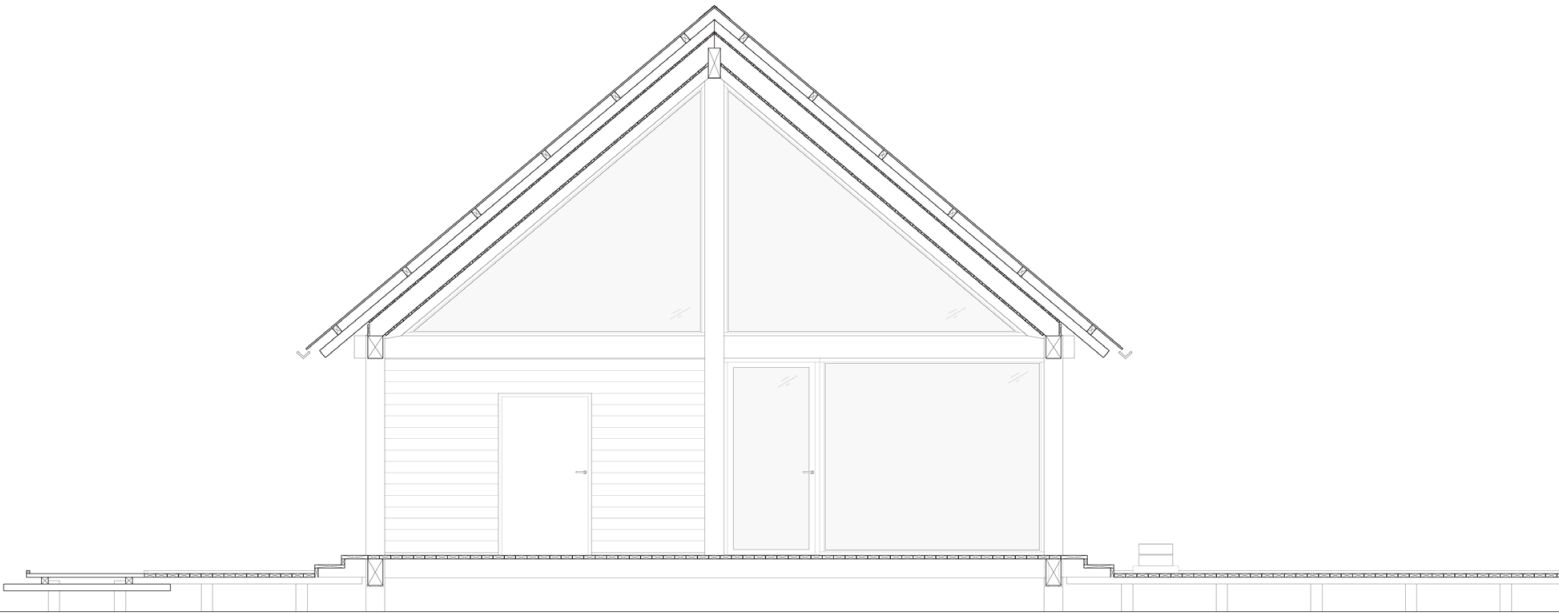

B-B

Section 1:100

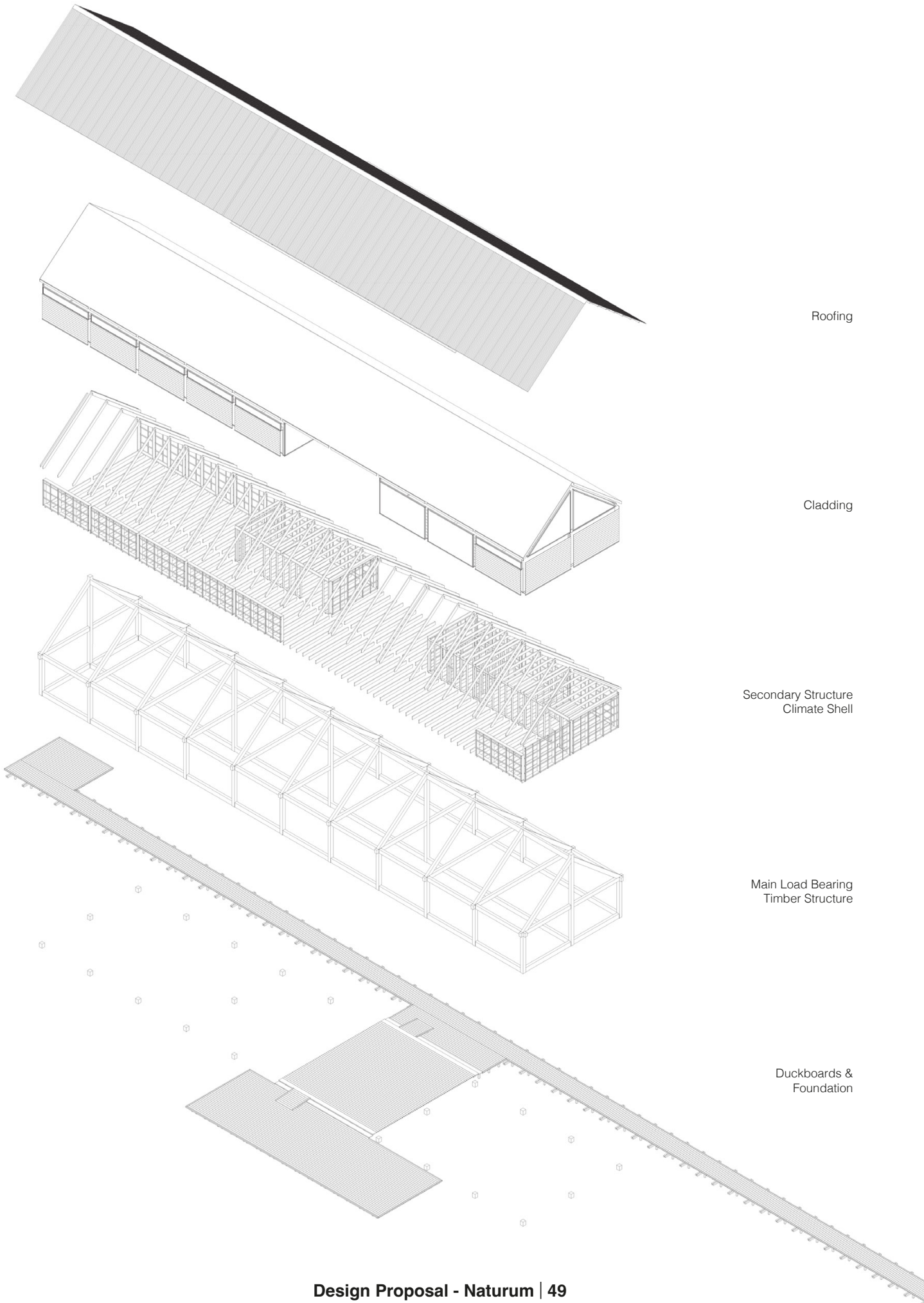

Roofing

Cladding

Secondary Structure
Climate Shell

Main Load Bearing
Timber Structure

Duckboards &
Foundation

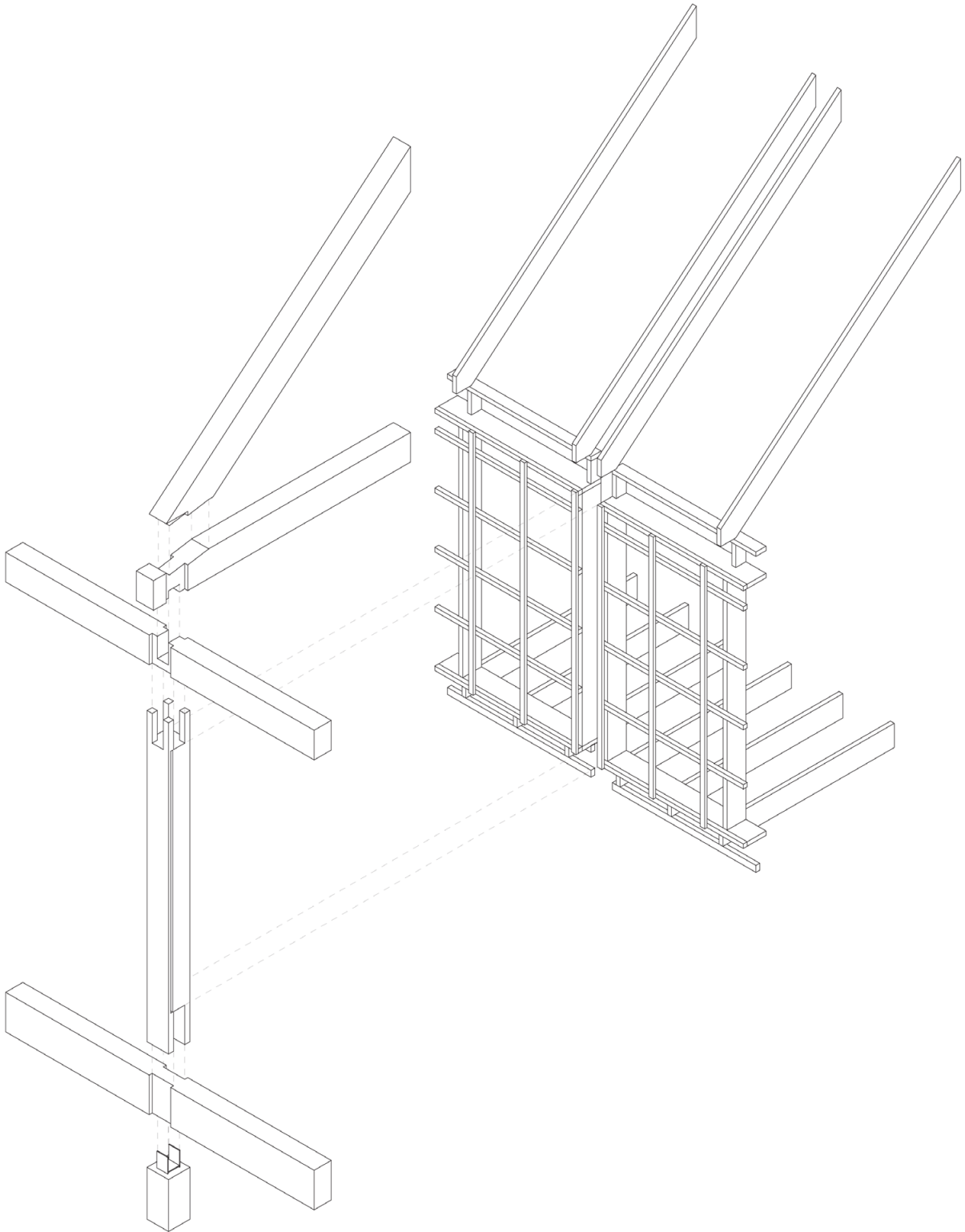



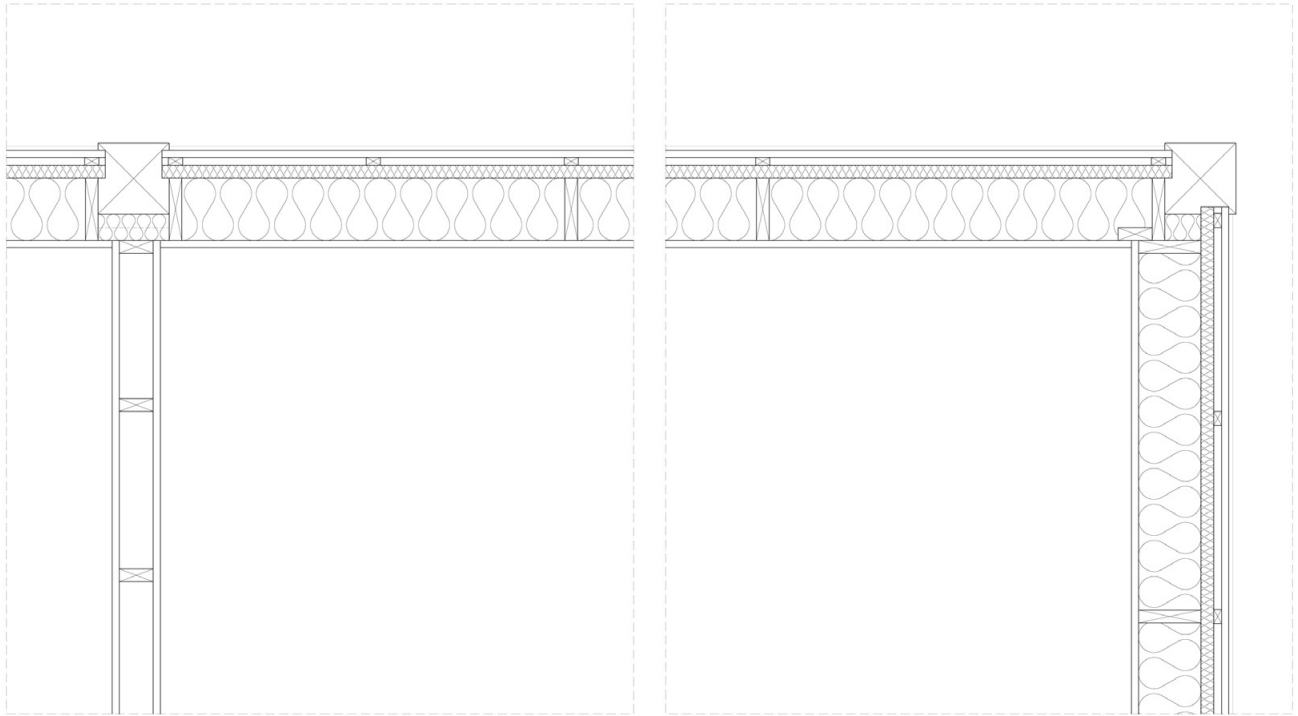

Horizontal Detail Section 1:50

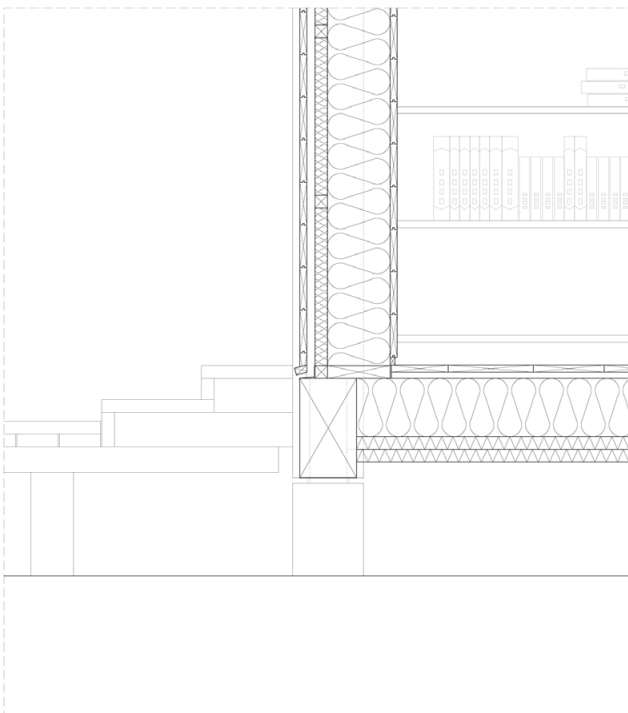
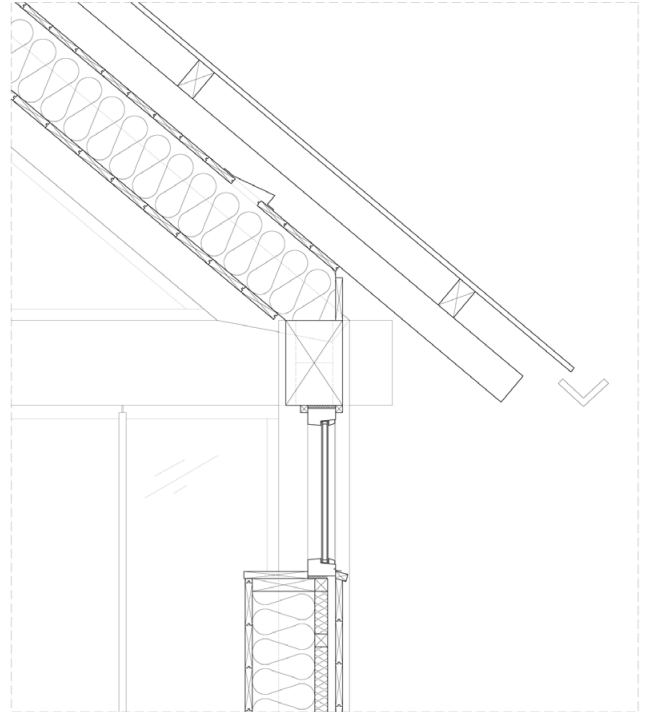
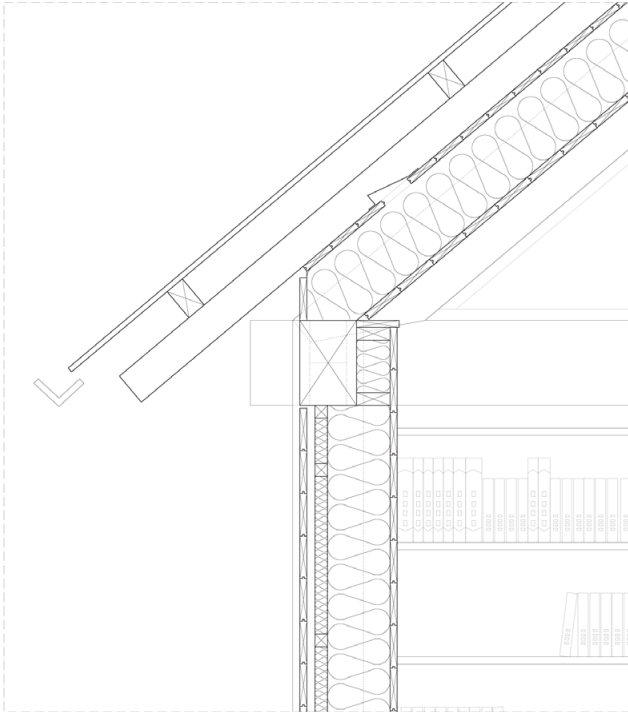

(mm)

ROOF

- Corrugated Roofing Sheet
- 75x100 Batten
- 75x100 Counter Batten
- Underlayment
- 22x120 Tongued and Grooved Board
(25 Air Gap)
- 245x45 Studs/Isolation
- 25x150 Panel

WALL

- 25x150 Panel
- 28 Air Gap
- Wind Deflection
- 45x45 Studs/Isolation
- 220x45 Studs/Isolation
- 25x150 Panel

FLOOR

- 28 Floor Planks
- 22 Fibreboard/Floor Heating
- 245x45 Studs/Isolation
- 45 Hard Isolation

Vertical Detail Section 1:50



Model 1:50



Model 1:50

Birdwatching Tower | Concept

The second part of the project is the birdwatching tower that forms the end destination of the narrative around experiencing Taglamyren and its nature through architecture. In contrast to the horizontal line that the naturum forms into the landscape, the birdwatching tower forms a vertical line as a symbolic destination marking the summit of the experience.

Taking inspiration from both corner joint and timber frame structures, the birdwatching tower is an interpretation of these two techniques combined. The corner joint structure forms a inner core in the building. The joints are simplified into logs that are staked and locked into place without intricate joinery, but instead with simple plugs hidden between the seams, still keeping the structure possible to disassemble. Around the core a more transparent structure is formed with a structure inspired by timber frame buildings.

The core forms a more protected inner part of the tower that makes the tower be more than just for birdwatching. The protected core provides for taking a brake or maybe even eat some meal or drink coffee one might have brought. The core is rotated differently for each level of the tower, framing different views for each level.

The timber frame structure acts as vertical transportation in the structure and is clad in a wooden panelling. The panels are placed with gaps similar to the barns that had these gaps to let the wind dry the hay inside. For the tower the function is to create an interesting light inlet. Openings are created in the panels to orchestrate and frame the views in a playful but deliberate way. The facade towards the forest and the south is playfully inverted to let in more light as well as to make it feel that one kind of climbed in the trees.

Up on the last floor one get out on top over the trees to get a 360° view of Taglamyren nature reserve marking the summit of experiencing the reserve. For disabled people a platform is placed that is reached by going trough the tower where one can experience the open landscape as well.







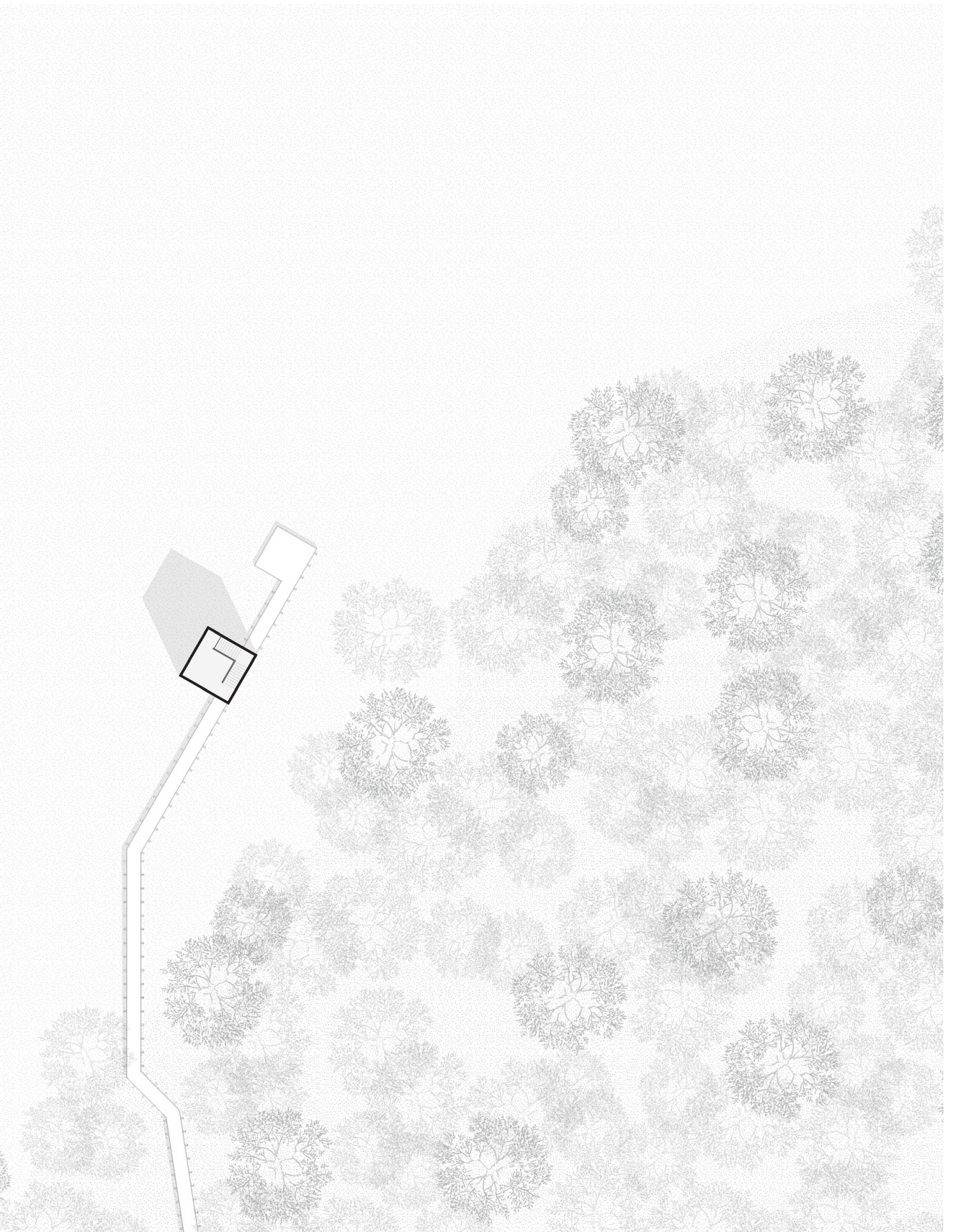

Site Plan 1:2500

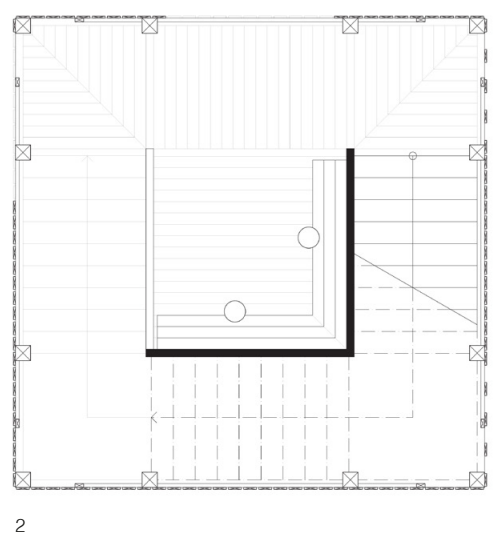
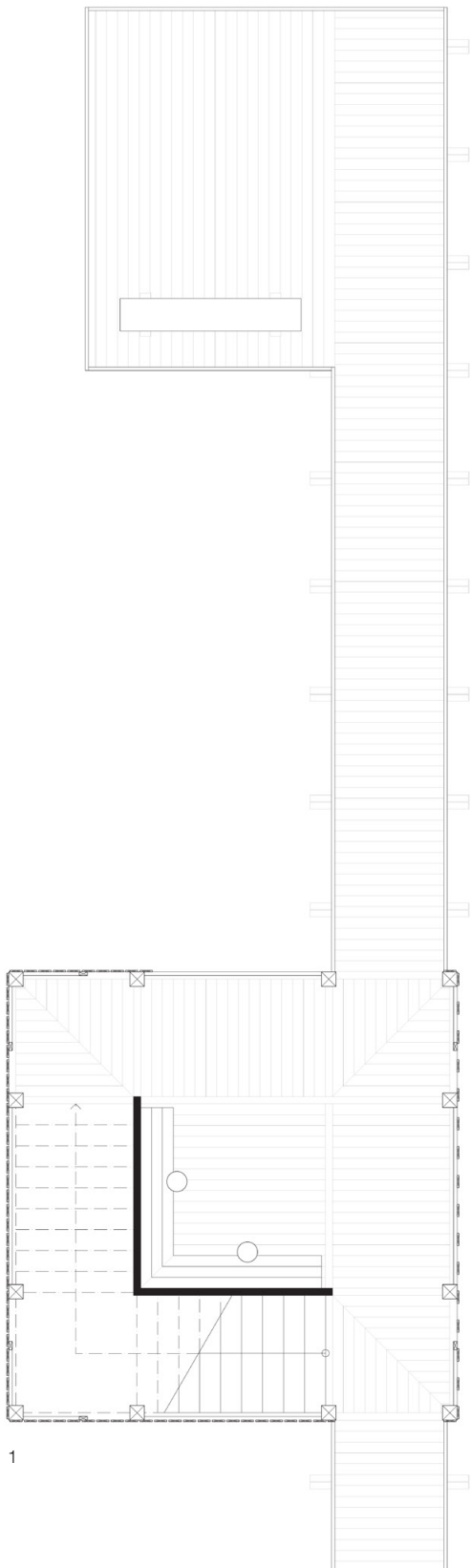

Floor Plans 1:100

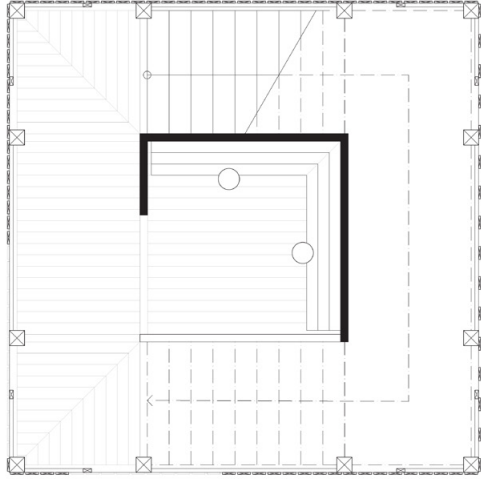

3

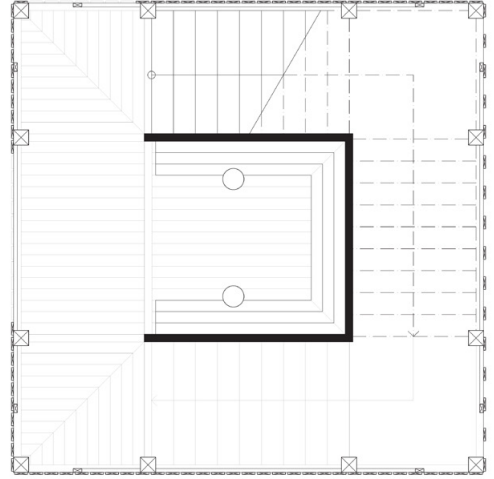

4

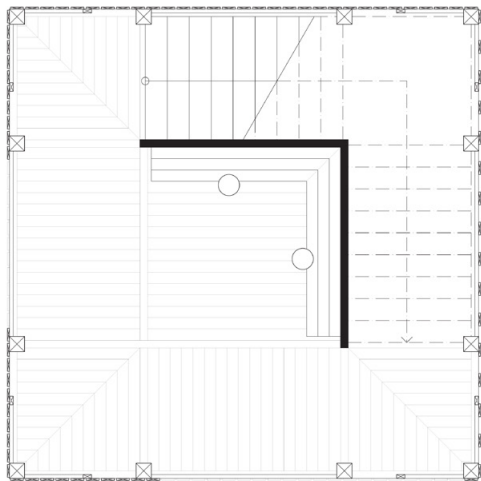

5

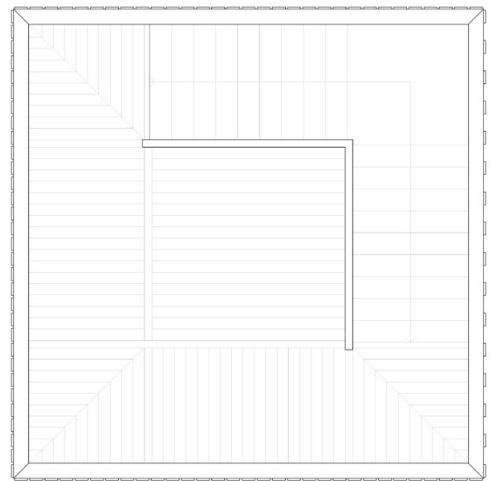

6



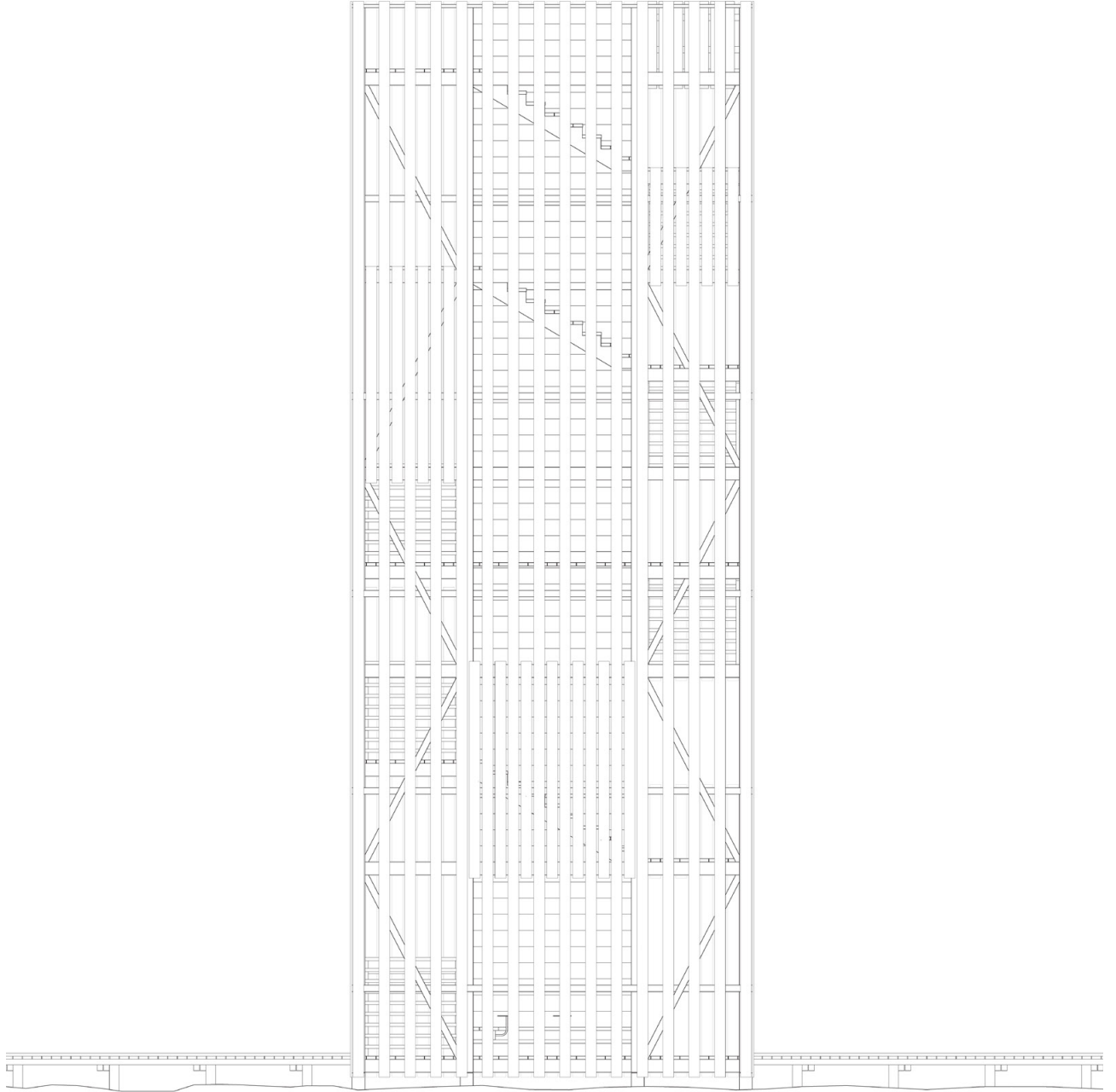

Elevation East 1:100

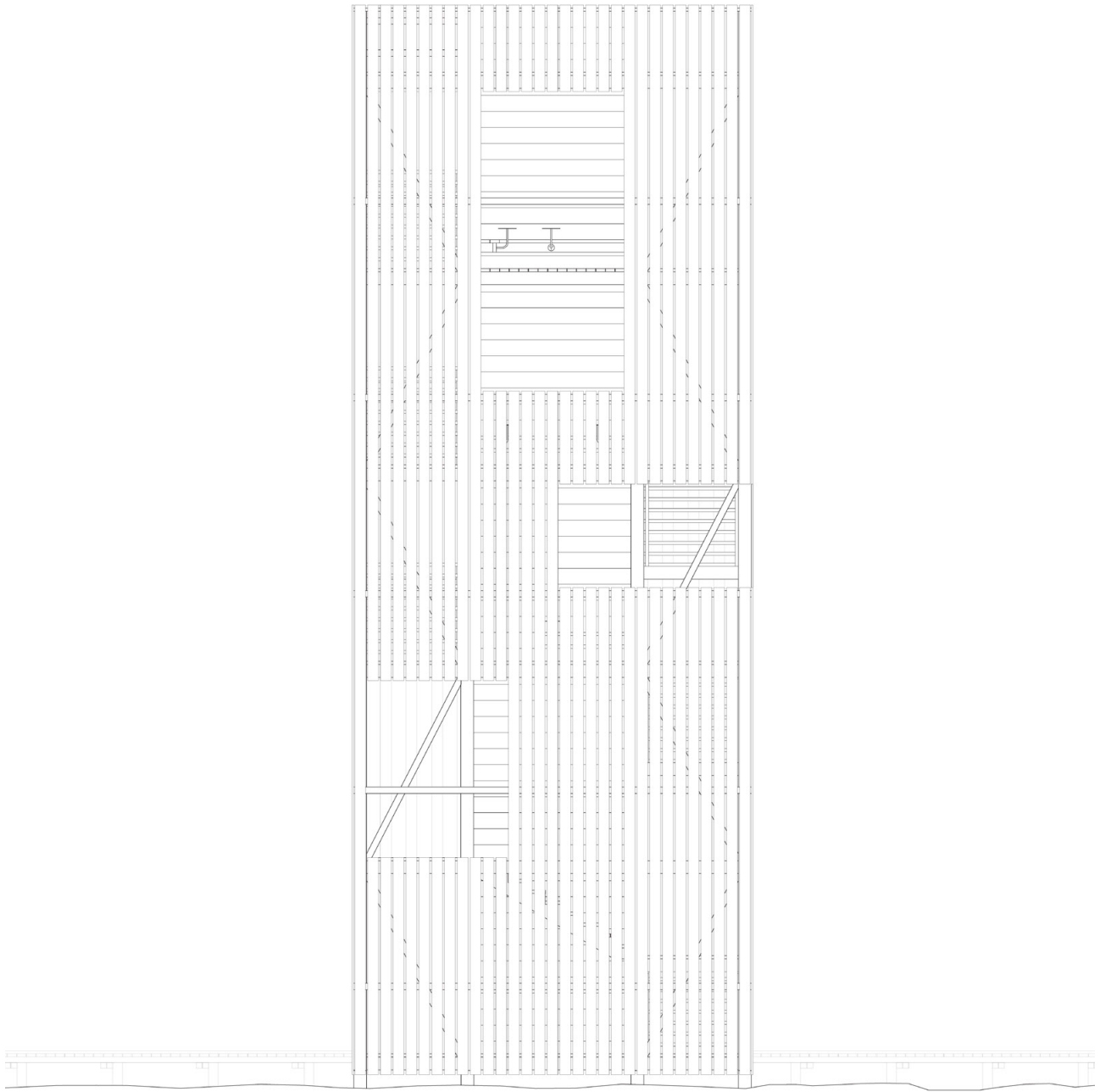

Elevation West 1:100

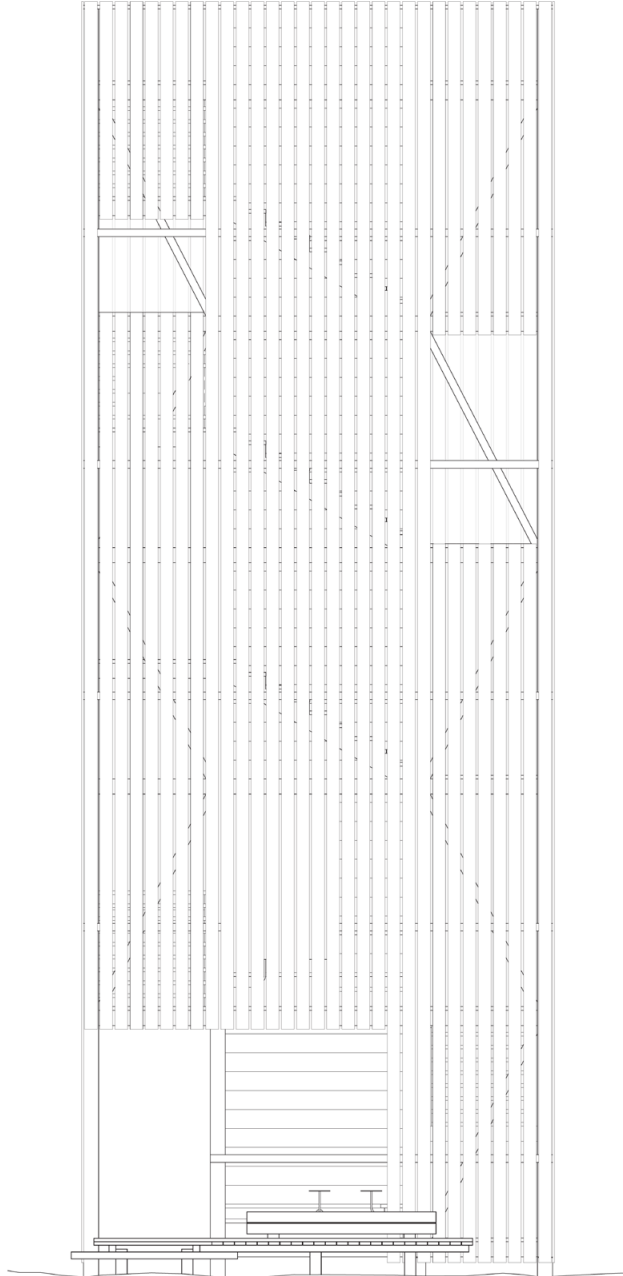

Elevation North 1:100

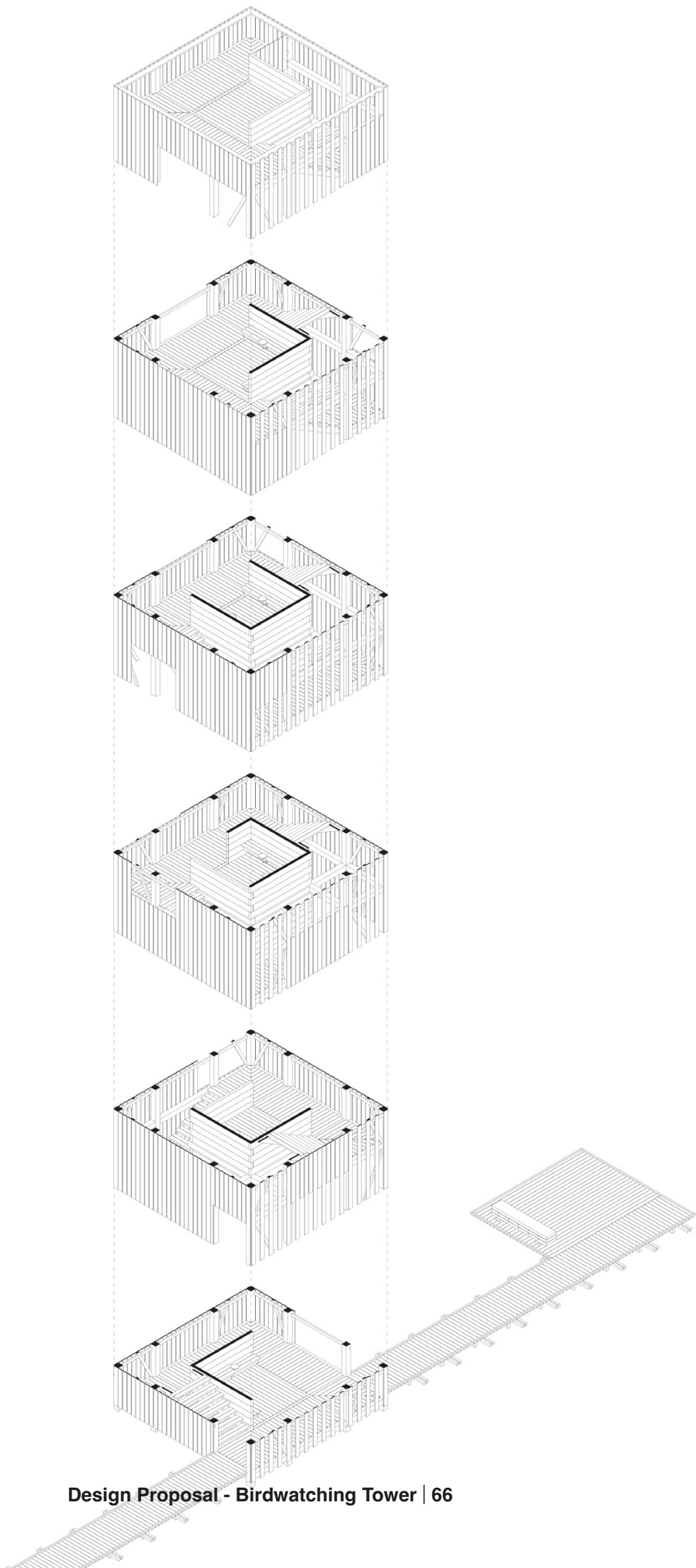





Model 1:50



Model 1:50

Conclusion & Discussion

This project set out to bridge the gap between traditional Swedish farm building techniques and contemporary architectural standards, with a focus on energy efficiency, resilience, and integration with the natural environment. Through the design and construction of a naturum visitor centre and a birdwatching tower in the Taglamyren nature reserve, I explored the rich cultural heritage of Småland's vernacular architecture and adapted it to meet modern needs.

One of the primary challenges encountered was integrating modern energy-efficient elements into traditional timber construction. For example, the design had to accommodate contemporary insulation requirements without compromising the aesthetic and structural integrity of the buildings. The decision to use a method similar to the Yomogidai House, which concealed some of the visible skeletal structure, was a necessary compromise to achieve airtightness and energy efficiency. This choice, while sacrificing some traditional visual elements, ensured that the buildings met current standards for energy performance.

Developing traditional timber building techniques to meet today's standards can significantly contribute to the revitalization of these building types, highlighting their cultural importance. This project demonstrates how traditional methods can be adapted to contemporary needs, preserving the craftsmanship and historical significance of farm buildings while making them relevant and practical for modern use. By integrating advanced insulation and other modern construction techniques, the project showcases the potential for traditional timber buildings to meet contemporary standards for energy efficiency and resilience.

A critical aspect of the project was ensuring that the new structures blend seamlessly into the Taglamyren nature reserve without disturbing the natural landscape. The design process prioritized minimal environmental impact, respecting the untouched bogs and wide expanses of the reserve. The careful placement and design of the buildings aimed to enhance the visitor experience without detracting from the natural beauty of the area.

The naturum visitor centre and birdwatching tower are designed to educate and inspire visitors about nature, aligning with the goals of naturum facilities. By providing educational resources for school classes, seasonal birdwatchers, and visitors unfamiliar with nature, the project underscores the importance of environmental conservation and cultural heritage. The birdwatching tower, inspired by traditional techniques, also supports local wildlife, offering an unobtrusive way for visitors to engage with the bird life of the reserve.

The project illustrates two different approaches to integrating traditional techniques with modern construction standards. The naturum visitor centre reimagines local timber construction traditions, while the birdwatching tower offers a more direct application of vernacular building methods, but in a contemporary interpretation. Both structures highlight how traditional Swedish craftsmanship can be blended with contemporary architectural principles to create buildings that are both culturally significant and technologically advanced.

While the project succeeded in many areas, some parts were more challenging than anticipated. The integration of artificial lighting, for instance, requires further refinement to balance functionality with the preservation of traditional aesthetics. Additionally, some elements of the design are more honest in showcasing traditional craftsmanship than others, underscoring the need for a careful balance between heritage and innovation.

Ultimately, this project demonstrates that old farm buildings can indeed be considered architecture of significance. By blending traditional Swedish craftsmanship with contemporary architectural principles, the project preserves cultural heritage while meeting the demands of modern construction. This approach not only revitalises the building type but also ensures its continued relevance for future generations. The successful integration of the buildings into their surroundings further emphasizes the potential for such designs to harmonize with both cultural and natural landscapes.



Literature

Caldenby, C., Lauri, T., Isitt, M., Ågren, M. (2013). Sveriges naturum. Arkitektur förlag.

Deplazes, A. (2005). Constructing architecture: materials, processes, structures. Birkhäuser - Publishers for Architecture.

Henriksson, G. (1996). Skiftesverk i Sverige - Ett tusenårigt byggnadssätt. Bygghögskolebyråns utredning

Lange, U. (2011). Ladugården, Om lantbrukets bebyggelse och arkitektur 1600-2000. Nordiska museets förlag.

Rosander, G. (red). (1986). Knuttimring i Norden: Bidrag till dess äldre historia. Dalarnas Museum.

Sallnäs, M. et al. (2004). Lantbrukets äldre ekonomibygnader. Länsstyrelsen i Kronobergs län.

Articles

Bodin, A. (2020). Den svenska ladan. Fetched 15 September, 2023, from <https://www.sfv.se/upptackmer/kulturvarden/sok-innehall/kulturvarden-4-2020/den-svenska-ladan/>

References

Arch Daily. (2013). Atnbrufossen Vannbruksmuseum / L J B. Fetched 1 March, 2024, from https://www.archdaily.com/431676/atnbrufossen-vannbruksmuseum-l-j-b?ad_medium=gallery

Arch Daily. (2020). Yomogidai House / Tomoaki Uno Architects. Fetched 1 March, 2024, from <https://www.archdaily.com/937243/yomogidai-house-tomoaki-uno-architects>

Dezen. (2016). OOPPEAA builds wooden Periscope Tower beside lake in Finland. Fetched 30 April, 2024, from <https://www.dezeen.com/2016/07/08/wooden-periscope-tower-ooppea-hilltop-lake-finland-cross-laminated-timber/>

White. (2003). Naturum Store Mosse. Fetched 15 September, 2023, from <https://whitearkitekter.com/project/naturum-store-mosse/>

Visuals

If not stated otherwise, pictures and drawings by author (2022-2024)

s.21

Plank and posts construction details [Illustrations], by Gunnar Henriksson, 1996, Skiftesverk i Sverige

Plank and posts construction details [Illustrations], by Johan Jönsson, 2017, Metoder för att utforma fackfyllnadens möte med stolpen i ett halvnaket skelettverk

s.29

Interior and Exterior of Naturum Store Mosse [Photograph], by Mikael Olsson, (n.d) , White

Floorplan [Drawing], by White, 2003 , White

s.31

Interior and Exterior of Yomogidai House [Photograph], by Ben Hosking, (n.d) , Arch Daily

Floorplan [Drawing], by Tomoaki Uno Architects, 2018 , Arch Daily

s.33

Interior and Extiroid of Atnbrufossen Vannbruksmuseum [Photograph], by Marchesi, Hellum & Stikbakke, (n.d) , Arch Daily

Floorplan [Drawing], by Marchesi, Hellum & Stikbakke, 2013 , Arch Daily

s.29

Interior and Exterior of Naturum Store Mosse [Photograph], by Mikael Olsson, (n.d) , White

Floorplan [Drawing], by White, 2003 , White

Mater Thesis in Architecture
Building Design & Transformation | Spring 2024

Taglamyren Naturum Visitor Centre
Adapting Swedish timber building traditions for
today's needs

Author: Sam de Jong

Chalmers University of Technology
Department for Architecture and Engineering
MPARC Architecture and Urban Design

Supervisor: Björn Gross
Examiner: Mikael Ekegren