

RAISE YOUR STANDARDS

an investigation of how design attributes improve the quality in apartments

Ellen Bensköld

Chalmers University of Technology
Department of Architecture and Civil Engineering

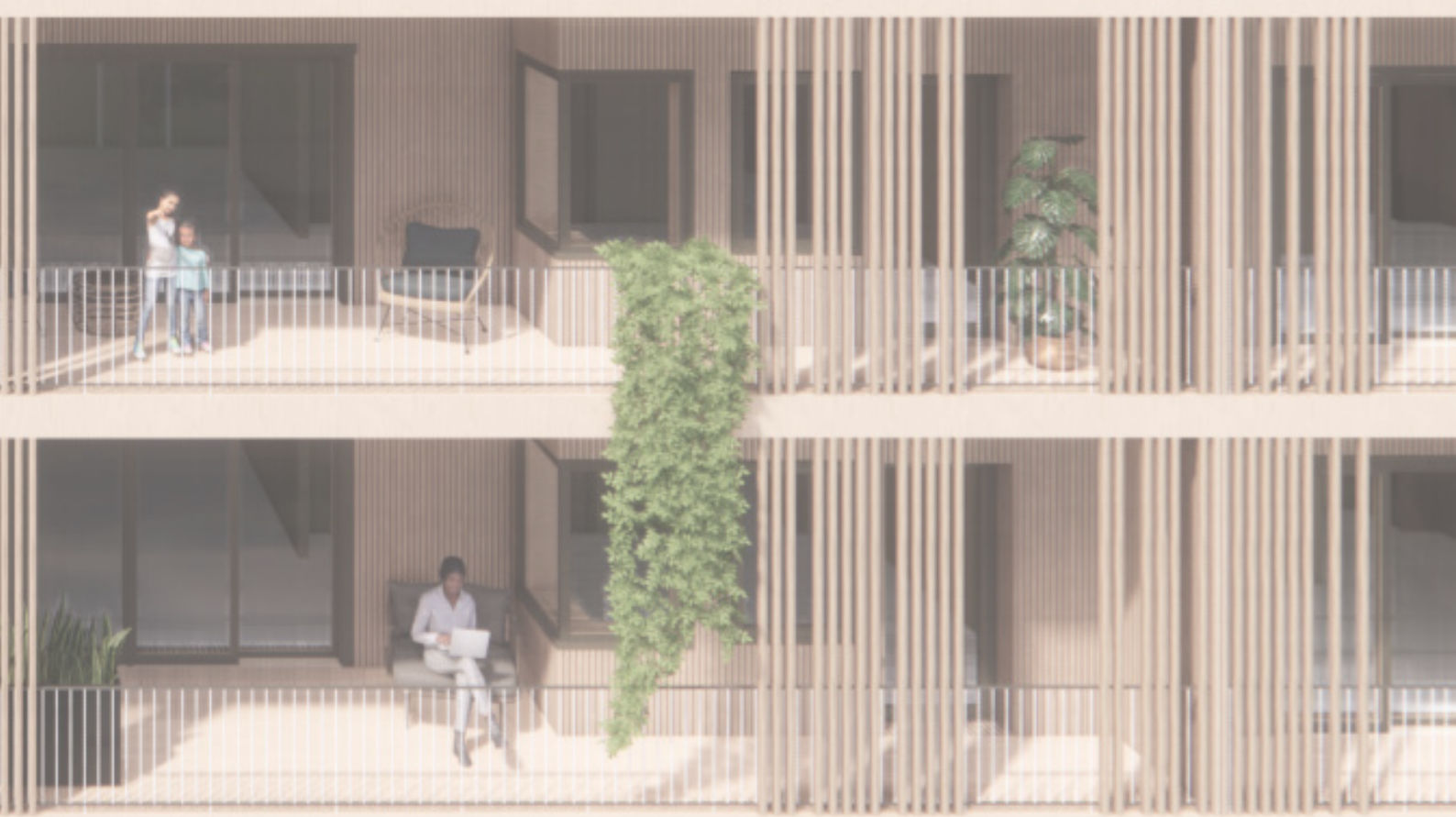
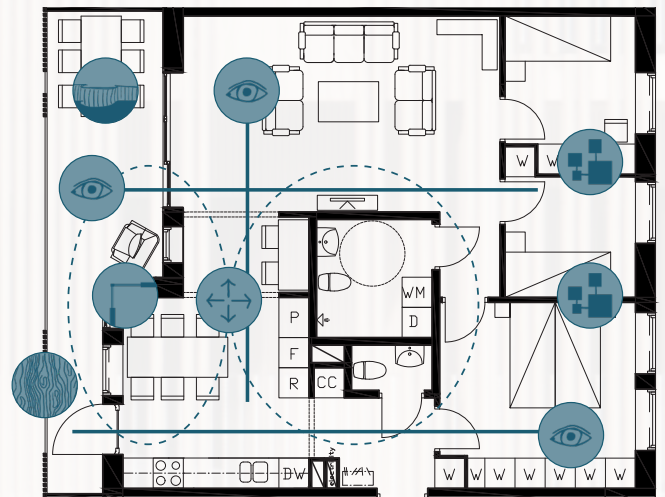

RAISE YOUR STANDARDS

an investigation of how design attributes improve the quality in apartments



CHALMERS

Ellen Bensköld

Supervisor: Anna Braide
Examiner: Kaj Granath

Chalmers School of Architecture
Chalmers University of Technology
Department of Architecture and Civil Engineering

Master's programme of
Architecture and Urban design (MPARC)
ACEX35, Master's Thesis, Spring semester, 2023
Housing Direction

ABSTRACT

The housing construction industry in Sweden faces several challenges, such as a housing shortage, slow building pace, high prices, and low-quality residences. To maximize profits, construction companies prioritize quick and cheap building projects, resulting in smaller apartments with a concerning lack of qualitative features such as axiality and circular movement.

The purpose of this thesis is to draw attention to design attributes as an important part of housing architecture, and its contribution to the advancement of architectural quality. The thesis explores several design attributes in contemporary housing architecture and investigates how they can be incorporated through floor plans in an existing, newly developed, housing proposal.

The aim is to redesign the apartments in an existing proposal incorporating design attributes without compromising the building's program. The final proposal illustrates how design attributes are incorporated in different types of apartments and investigates the impact of the changes on the existing building volume. Eventually demonstrating area efficient apartments that through design attributes have achieved high architectural quality.

The research questions focus on how design attributes improve the quality in different types of apartments and explore their impact on the building itself compared to the existing proposal.

- **Q1.** How can design attributes improve the quality in different types of apartments?
- **Q2.** What impact do design attributes in apartments have on the overall building?

The thesis investigation has been conducted as a collaboration between five main methods: research for/on/by design, literature studies and case studies. Literature and case studies have gathered information on the topic, built a foundation for further investigation and defined the design strategies that are being used. Lastly the thesis practices research by design carried out by using several design attributes as strategies in the design proposal.

Keywords: design attributes, quality, floor plans, area efficiency



ELLEN BENSKÖLD

**MPARC Architecture and
Urban Design**

Contact Details
0704749010
e.benskold@gmail.com

EDUCATION

Master
Chalmers Architecture and Urban design
2021-2023

Master studios
Material & Detail
Housing Inventions
Residential healthcare - housing for seniors

Master courses
Building Climatology for Sustainable Design
Nordic Architecture
Sustainable Development and the design professions

Bachelor
Chalmers Architecture
2017-2020

Abstract	I		
About the author	II		
Contents	III		
01. INTRODUCTION	4		
Discourse	5		
Purpose	6		
Aim	6		
Research questions	6		
Method	6		
Theory	7		
Delimitations	7		
Reading Instructions	7		
Terminology	7		
02. BACKGROUND	8		
Historical Overview	9		
Lack of qualities	9		
03. RESEARCH	10		
Description of research	11		
Architectural quality	11		
Good floor planning	11		
Design attributes	12		
Apartment sizes	13		
Apartments today	14		
<i>Shrinking sizes</i>	15		
<i>Comparison of similar apartments</i>	16		
<i>Conclusions</i>	16		
The balcony as a quality	17		
MAB	18		
04. CASE STUDY	22		
Analysis of apartments	23		
Cases	23		
<i>Apartment A</i>	24		
<i>Apartment B</i>	26		
<i>Apartment C</i>	28		
<i>Apartment D</i>	30		
Conclusion	32		
<i>Negative qualities</i>	33		
<i>Positive qualities</i>	33		
<i>Summarise of case study</i>	33		
05. REFERENCE PROJECTS	34		
Botanikern	35		
Alfa	36		
Strandparken	37		
Analysis of reference projects	38		
<i>Conclusions</i>	39		
06. DESIGN STRATEGIES	40		
Research findings	42		
Design strategies	43		
07. DESIGN PROPOSAL	44		
Site	46		
Skanska	46		
Project Klassrummet	46		
Existing project	48		
<i>Building</i>	49		
<i>Standard floor</i>	49		
<i>Building analysis</i>	50		
Design process	51		
Building Sections Facades	52		
<i>Building</i>	56		
<i>Standard floor plan</i>	56		
Design strategy implementation	57		
Entrance floor	58		
Standard floor	60		
Apartments	61		
<i>Apartment I</i>	62		
<i>Apartment II</i>	64		
<i>Apartment III</i>	66		
<i>Apartment IV</i>	68		
<i>Apartment V</i>	70		
08. DISCUSSION	72		
Comparison	73		
Summary	77		
Conclusion	77		
<i>Thesis research questions</i>	77		
Reflections	77		
<i>Further improvement to the project</i>	77		
09. REFERENCES	78		
Literature references	79		
Bibliography	80		

01. INTRODUCTION

Discourse

Housing architecture plays a critical role in shaping our daily lives. It is the foundation upon which we build our homes, our communities and our memories. The quality of the residence is therefore essential for ensuring that we have safe, functional, and comfortable living spaces. The main focus of this thesis will be on the architectural qualities of housing design and the corresponding design attributes necessary to achieve high quality.

The housing construction industry in Sweden is facing several challenges, including a housing shortage, slow building pace, high prices, and low-quality residences. Due to the ongoing housing shortage, all types of apartments are in high demand, leading construction companies to prioritize quick and cheap building projects to maximize profits. Consequently, this results in an increasing occurrence of apartments being built in smaller sizes at the expense of qualitative features (Caldenby, & Hallemar, 2020).

It is all too common to have low-quality solutions at high prices when it comes to the current housing design. As a result, the living space is smaller and offers poorer functionality, limited furniture placement options, and decreased usability (Nylander et al., 2018).

“The 2010s decade stands out, for the first time in Swedish housing history, as a period where the architectural qualities decrease instead of rise.”

Ola Nylander
(Caldenby, & Hallemar, 2020, p.39.)

(original quote: “Tioalet utmärker sig, för första gången i den svenska bostadens historia byggs det sämre bostäder än under föregående decennier.”)

According to Nylander (2021), architectural quality in residential buildings is frequently disregarded since it is viewed as an optional aspect of the design process. Nonetheless, Nylander contends that architectural features are critical to the advancement of housing architecture, since residences with superior architectural quality can increase well-being, and also affect our health.

Relevance

Per Bolund, the Minister of Financial Markets and Housing in Sweden, has expressed concerns about the impact of decisions based solely on the lowest cost in the construction industry. According to Bolund, the Swedish government sees a risk of compromising the quality of the built environment due to this approach. By focusing solely on the lowest cost, there is a risk of compromising the quality, aesthetics, and social sustainability of the final outcome, which could result in buildings that are less durable. (Arkitekten, 2020).

According to a study by Nylander et al. (2019), which examined building permits issued in Gothenburg in 2016, many new construction projects in the housing market do not meet the desired quality standards. To speed up the design and construction process, some of the regulations previously imposed on the building industry have been removed. However, these regulations were once considered essential, and as a result of their removal, newly constructed housing projects are lacking in quality.

The study of building permits and the concern from the government both indicate that qualitative attributes in housing, such as circular movement, axiality and qualitative materials, are lacking. It is therefore of relevance to contemporary architecture to investigate and present examples that demonstrate how things can be improved. It is a goal in architecture to prioritize sustainability, and by concentrating on a residence’s architectural qualities, social sustainability can be brought to the forefront.

Contribution

The primary objective of this thesis is to draw attention to housing architecture as an important part of housing construction. This is accomplished by showcasing an example of a current housing project where design strategies have been employed to integrate relevant qualitative design solutions in the floor planning.

The contributions made to the field of architecture through this work may not be groundbreaking in terms of introducing a new approach to designing residential spaces. However, it aims to provide an illustration of how qualitative design attributes can be incorporated into different types of apartments. The investigation will be conducted within the context of an existing design proposal to ensure relevance.

Purpose

The purpose of this thesis is to explore the use of design attributes in contemporary housing architecture and illustrate how they can be integrated into a newly developed housing project to improve its quality.

The ambition is to display the design attributes, utilize them as design strategies and integrate them into the current design program to enhance the building's quality without making significant alterations to its structure. The thesis includes a redesign of both the apartments and building, and the resulting modifications will be evaluated for their impact on the original design proposal.

Aim

The thesis aims to acknowledge the importance of design attributes to achieve architectural quality and encourage further discussions about these qualitative features in housing design. The intention is to demonstrate the substantial improvement in the apartment's quality with the new design that incorporates all the selected design attributes.

Further, the aim is to foster quality without compromising the building's program, such as its size and number of apartments. Nevertheless, accomplishing this goal can be challenging. As a result, the objective is to explore the impact of the alterations on the current proposal, prompting a conversation about prioritizing quality versus economic benefits.

The aspiration of the idea behind this thesis is to promote feasible and affordable architecture in the built environment, rather than pursuing unrealistic goals.

Method

The thesis has been conducted through five main methods: research for/on/by design, literature studies and case studies. These methods have been used back and forth through three different phases of the thesis: Theoretical studies, Framework and Design.

Theoretical studies

To gather information on the topic and build a foundation for further investigation on the subject, the main method for this phase is research for design through theoretical studies. The literature is gathered from published books, academic and scientific reports and some online sources. The research defines the design principles that will be used in the following parts of the thesis.

Framework

The framework is built up to drive and support the design phase and is mainly conducted by research on design through analyzing case studies. The cases explored are relevant apartments from the housing project Klassrummet in Mölndal, Gothenburg. The phase of the framework ends with a summary of the design strategies that are being incorporated as a base in the design proposal.

Design

The final phase uses research by design carried out by using the defined design strategies in a design proposal. The project proposal is a redesign of apartments and facade to investigate the design strategies rather than critique the original project proposal Klassrummet. The final result will include floor plans, apartment floor plans, facade drawings, exterior and interior perspective and a comparison with the original proposal.

Theory

The theory of the thesis is roughly divided into two main parts.

The first part focuses on published books and literature about contemporary architecture and architectural quality in housing design. Most of the work that's being investigated is done by professors at Chalmers University of Technology, such as the books "Bostadens omätbara värden" (Nylander & Forshed, 2011), "Tiotalets svenska bostad" (Caldenby & Hallemar, 2020) and "Bygglov Göteborg 2016" (Nylander et al., 2019).

The second part of the theory consists of a scientific report called "MAB, Manual för analys av bostadskvaliteter" by researchers at CBA (Granath & Nylander, 2023). MAB can be summarized as an analytic tool that qualifies 28 housing qualities and is a way to measure architectural quality in a residence.

Delimitations

The thesis focuses on a Swedish context in Gothenburg, meaning that design attributes are being considered following Swedish climate, standards and regulations. Literature references are mainly from Swedish sources since the regulations and attributes in the built environment are a bit different according to each country.

Design Project

The investigation includes an adaptation of an existing design project for a newly developed apartment building that is currently under construction. The site is called Pedagogen Park and is locally situated in Mölndal, Gothenburg.

The building program such as volume, placement on the site, number of entrances and staircases will be kept unchanged. The existing number of apartments will function as a goal, but not as a limit, creating some space for alteration. The thesis design proposal is a new suggestion of the facade and floor plans using several design attributes to enhance architectural quality. While the focus of the investigation is on improving architectural quality, it is worth noting that the changes being made will have economic consequences. However, the thesis excludes the economic aspect for the aforementioned reason.

Reading Instructions

The thesis is divided in eight chapters composed in three different phases. The chapters presented in the thesis are as follows: Introduction, Background, Research, Case study, Reference projects, Design strategies, Design proposal and Discussion.

Phase 1 presents the thesis and its frame as well as background for the subject.

Phase 2 consists of the framework for the design proposal and includes the chapters of research, case studies, reference projects and design strategies. This phase presents the theory in the form of literature research and will end with a list of design attributes to use as design tools.

Phase 3 introduces the design proposal and showcases the findings of earlier chapters in a local context. Lastly the thesis sums up with a discussion including conclusions and reflections.

Q1 is studied and discussed during the case studies and later answered in the chapter Design proposal.

Q2 is investigated and answered during the chapter Design proposal.

Terminology

Architectural quality

The result of designing with several design attributes.

Design attributes

Features such as axiality, movement and material.

CBA, Centre for Housing Architecture

A national platform based in the Department of Architecture and Civil Engineering at Chalmers University of Technology for knowledge dissemination, discussion, development, and research related to housing and accommodation.

MAB, Manual for analysis of housing qualities

MAB is a quality assurance analyzing tool comprising 28 housing qualities that are analyzed and recorded in an Excel sheet accompanied by a describable manual.

r.o.k

Swedish measurement for the type of apartment, translated as "room and kitchen". "Room" refers to both living room and bedrooms.

SCB (Statistiska centralbyrån)

The Statistics Authority in Sweden

Research questions

Q1. How can design attributes improve the quality in different types of apartments?

Q2. What impact do design attributes in apartments have on the overall building?

02. BACKGROUND

Historical overview

The requirements for the residence have changed over time based on contemporary needs. In the early 1920s, the aim was to ensure that everyone had access to hygienic and minimally comfortable living spaces. As the decades progressed, the building industry received support from the state, resulting in higher standards and qualitative buildings, with many residences built in the 1950s still offering quality materials and design attributes such as wooden flooring and circular movement (HSB, n.d.).

Following decade, Sweden faced a housing shortage and an economic crisis. In response to this problem, the Million program emerged as a significant initiative during the 1960s and 1970s to address the severe lack of housing. Its primary objective was to construct one million new homes within ten years, with the aim of providing contemporary and affordable housing to all. (Stockholmskällan, 2022).

After the Million program, there was an increased demand on design attributes in the apartment, such as axiality, movement, and the necessity of a balcony. However, in the 2010s, the priorities shifted and cost-efficient buildings resulted in a lack of these attributes. At the same time, sustainability in structure and facade became a key factor in contemporary architecture. The trend towards sustainability has continued to influence the building industry, resulting in greater development of buildings made of wood (HSB, n.d.).

Lack of qualities

The present scarcity of housing has resulted in an increased demand for apartments, causing a rise in housing prices. This trend has made both well-designed and poorly-designed apartments attractive to residents. The high demand, elevated profits, and expensive housing prices have resulted in smaller apartment sizes. Traditional building types such as access balcony apartments and high-rise buildings are making a comeback in the construction industry, but without the quality requirements that were previously imposed. As a result, the construction of apartments in Swedish housing in the 2010s is of lower quality than in earlier decades. Caldenby refers to architecture as the careful work of architects from floor plans to the smallest details, but suggests that this is far from common in contemporary Swedish housing. Caldenby argues that wealthier than ever before, our society should not settle for inferior architecture compared to previous generations (Caldenby, & Hallemar, 2020).

Small apartments have become more common in response to high prices, with 3-room and kitchen apartments shrinking in size from the 2000s to the end of the 2010s, as seen in the chart below. Previously, large and high-quality apartments were necessary to entice buyers in the early 2000s when there were more apartments than buyers. (Caldenby, & Hallemar, 2020).

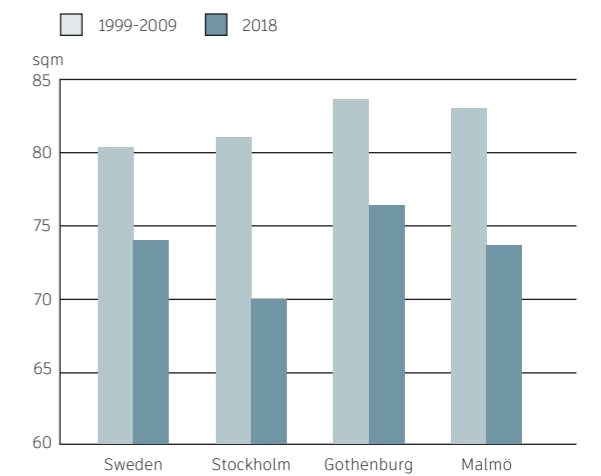

Shrinking apartment sizes | 3 rok | Figure 2.1

As demand increased in the 2010s, competition intensified, but quality standards from previous generations were ignored. Nylander argues that the 2010s decade marks the first time in Swedish housing history where the quality of housing design has declined compared to previous decades. For example, bedrooms facing a shared access balcony were previously considered unacceptable for privacy reasons and were ineligible for state housing loans in the 1950s. However, contemporary regulations allow for such solutions and can be found in several housing projects. This can be seen in the example from Brunstorp in Huskvarna featuring apartments with bedrooms facing shared access balconies (Caldenby, & Hallemar, 2020).

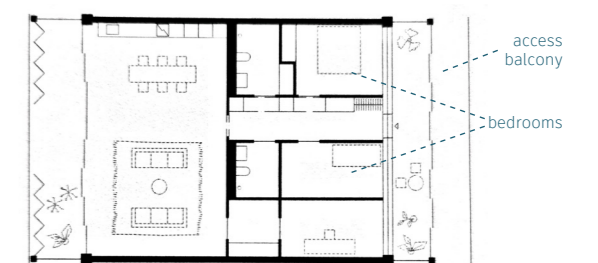

Floor plan | bedroom towards access balcony
Brunstorp, Huskvarna | Arrhov Frick | Figure 2.2

03. RESEARCH

Description of research

The research investigates the use of design attributes in apartments and examines the lack thereof in contemporary housing projects.

Nylander and Forshed (2011) dive further into explaining the design attributes and their importance for the residence. Roberts-Hughes (2011) addresses the issue of shrinking apartments and suggests that this is the reason that several desired attributes are missing. Nylander and Granath (Caldenby, & Hallemar, 2020), argue for the design and placement of the balcony, stating that it has a significant impact on its usability.

Furthermore, contemporary architecture is examined by showing several examples of approved building permits here in Gothenburg from 2016. These are examples of what is being designed and built today. The chapter ends with a brief overview of the analysis method MAB (Granath & Nylander, 2023), that defines the approach of the following case study and investigation.

Architectural Quality

The concept “architectural quality” can be described as a trinity between durability, utility and beauty. The three characteristics originate from the architect Vitruvius (Firmatis, Utilitas and Venustatis) who meant that good architecture in a building should involve all three equally. (Nylander & Forshed, 2011).

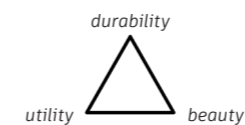

In the matter of durability, Vitruvius opined that a durable building should stand up robustly and be persistence over time regarding material and structure. Durability also applies to the design and form of the indoor rooms, due to changes of the family constellation, where different needs are required at different times. The utility in a building is directly connected to how needed functions are solved and refers to a well planned, useful and practical living space. Vitruvius' final attribute, beauty, is described as the part of architecture that is the hardest to measure. Beauty is seen in the eye of the beholder and in this matter, the most important aspect is what happens between the observer and the object. The purpose of beauty is to delight and raise people's spirits. Vitruvius opined that it's the cooperation of these three elements, equally measured, that create architectural quality (Pollio, 2016).

Good floor planning

According to Caldenby (Caldenby et al., 2019), architecture consists of both individual components and the whole structure, with each part holding equal significance in shaping the final outcome. These can be assessed based on five primary factors that impact the overall quality of the living space.

1. Well-studied plan

The well-studied plan can be explained as solving a crossword puzzle, where all dimensions are functional and balanced. Furthermore, a well-studied plan contains details such as placement of doors, if the door is right or left hinged and placement of wardrobes (Caldenby et al., 2019).

2. Geometric clarity

Geometric clarity is necessary for flexibility and generality, as it facilitates assessing the shape of the room. An easily read room has a coherent shape, often in the form of a rectangle. (Caldenby et al., 2019).

3. Proportionate rooms

Proportionate rooms refer to the size of the rooms being sufficient for the intended use. Attributes such as light and darkness are closely linked to the meaning of proportionate rooms since those affect the interpretation of the room (Caldenby et al., 2019).

4. Neat construction

Neat construction, also known as buildability, is essential for ensuring economic feasibility. It's important that the project has some sort of recurrent structure for it to be practicable (Caldenby et al., 2019).

5. A sense of spaciousness

A sense of spaciousness is achieved through the organization of rooms and openings. How these are placed affect the residence and create qualities such as circular movement, rooms in a row, axiality as well as light and dark areas (Caldenby et al., 2019).

Caldenby explains that these five elements also can be found, and are more thoroughly explained, in Nylander and Forsheds description of qualitative attributes, thus named differently (Caldenby et al., 2019).

The architectural quality of an apartment encompasses attributes like circular movement, axiality, room organization, materials, and detailing. To attain architectural quality, these values must be integrated into the apartment. This thesis defines architectural quality as the outcome of employing multiple design attributes within the apartment.

Design attributes

Nylander and Forshed (2011) describes the value of seven design attributes that create architectural quality in housing design. The attributes are a collection of different design methods, details, characteristics and features that have meaning for the experience of the residence.

Axiality

Important qualifications for an axis are the length and number of rooms that are involved, similarities, symmetry, repetition along the axis, the shape of openings through the line and lastly the starting and ending point (Nylander & Forshed, 2011).

Axiality of high quality binds together important parts of the apartment. An axis that links rooms of similar size, material, and light has a more pronounced axial expression (Nylander, 2021).

Material and details

High quality materials and a well done craftsmanship is meaningful for the experience of housing architecture. A qualitative housing material should be sustainable regarding resilience, the ability to age beautifully and easily be maintained. The attention and care for a building is reinforced by details, such as carefully placed meetings between different materials and integrated technical installations. Cooperation of materials, context and site brings quality to the residence (Nylander & Forshed, 2011).

Room organization

Room organization refers to the design of private and public areas and has a significant role to the experience of the residence. An example of room organization is to place all bedrooms together with the bathroom like a block. The organization of rooms can often be connected to a certain type of typology in the residence, such as a central floor plan or a zoned floor plan (Nylander & Forshed, 2011).

Integrity in your home is vital, therefore it's a necessity to be able to feel private in the residence as well as in adjacent surroundings. The balcony is an exceptional example of a buffer that connects indoor space with the outdoors through openness and light (Nylander & Forshed, 2011).

Enclosure - Openness

It's a quality to be able to experience both enclosure and openness in the residence. Openness refers to different kinds of openings in the wall, while enclosure refers to the wall itself. Openness in the facade reduces boundaries between inside and outside while enclosure emphasizes the feeling of safety. Except the number and size of the openings, the form, color and design also have an impact on the feeling of the room. Distinkt corners and whole pieces of wall enhance the readability of the room and promote furnishability (Nylander & Forshed, 2011).

Movement

The experience of a residence and its architecture as a whole is significantly influenced by the movement within it. The rhythm of movement through different rooms is determined by factors such as the size, shape, number of openings and their measures, as well as other attributes like axiality and natural light. Circular movement enhances the experience within the residence and allows for the rooms to be experienced both individually and in cooperation as a sequence (Nylander & Forshed, 2011).

Generality and flexibility

The availability and utility of a residence is influenced by the proportion and size of different rooms. To qualify as general and flexible, rooms should have more than one opening and allow for different options in movement. Flexible rooms should measure 3.6 meters or above in length and depth to accommodate several activities and promote furnishability. Additionally, rooms should have equivalents in material, details, and shape to make them equal, which increases the possibility for residents to use them as they see fit, promoting a changeable residence. (Nylander & Forshed, 2011).

Daylight

Daylight has a decisive impact on the architectural experience since it affects and appears through all the respective attributes, it can become a target in axiality or evoke movement. The design of windows is vital for a successful meeting between incident light and the indoor rooms. The light quality is dependent on the shape of windows and details in the frame as well as placement on the wall. Daylight with high architectural quality is enriched by a wide range of shadows and light play through the details of the window (Nylander & Forshed, 2011).

Apartment sizes

Choosing a home is a crucial decision, and the availability of space is a significant consideration for many. According to Roberts-Hughes (2011) investigation, it's a common belief among individuals in Great Britain that newly constructed residences are too small. A housing survey in Great Britain, investigated by Roberts-Hughes, demonstrates that a shortage of space can negatively impact fundamental lifestyle requirements, such as storage and room for entertaining guests. Additionally, a lack of adequate space can have a severe impact on health, education, and family relationships (Roberts-Hughes, 2011).

According to the survey (Roberts-Hughes, 2011), the top three things individuals prioritize when moving into a newly built home are outside space, room size, and proximity to local services, with 49%, 42%, and 42% of respondents citing these factors, respectively. 60% of people who would not buy a new home believe that the small size of the rooms is the primary reason, additionally, 31% of people would not consider purchasing a home built in the last decade, or would only do so as a last resort. Of those, 60% cited small room size as the reason, 46% said they lacked style, and 45% were concerned about insufficient outdoor space. It is noteworthy that newly constructed homes appear to fall short in providing two of the top three factors individuals in Great Britain consider important when moving: adequate indoor and outdoor space (Roberts-Hughes, 2011).

To address this issue, minimum space standards have been implemented in London by the Greater London Authority (GLA), as seen in the chart below, ensuring that homes provide sufficient space for basic furnishings and activities in an average household. The gross internal floor area for a residence is established by typology and the number of individuals it is designed to accommodate (Roberts-Hughes, 2011).

The required standards for housing in Great Britain are as follows:

Apartment type (bedroom (b) / persons (p))	Essential Area (GLA) (sqm)
1p	37
1b2p	50
2b3p/2b4p	61/70
3b5p/3b5p	86/95
4b5p/4b6p	90/99

Figure 3.1

In contrast to Great Britain, Sweden's regulations regarding the minimum area are determined by the number of rooms and size, where the demands change due to the named factors. The applied requirements include different levels of accessibility as stipulated in the BBR regulations. For instance, apartments under 35 square meters have no requirement for separability, which means that all functions except the bathroom can be in the same room and therefore only one window is sufficient for the apartment. (Boverket, 2020)

Nevertheless, the size of apartments in Sweden can be assessed by analyzing the average size of each apartment type over a specific period. The chart presented below displays the average area of Swedish apartment types over a three-year span from 2018 to 2020, based on data obtained from SCB through MAB (Granath & Nylander, 2023).

The average apartment sizes for apartments in Sweden are as follows:

Apartment type (r.o.k (room and kitchen))	Average Area (SCB) (sqm)
1 r.o.k	32,5
2 r.o.k	52,4
3 r.o.k	74,3
4 r.o.k	93,7
5 r.o.k	115,9

Figure 3.2

The way apartment sizes are communicated differs between Sweden and Great Britain, with Great Britain using the number of rooms and people, and Sweden using the number of rooms plus the kitchen. The charts suggest that smaller apartments in Sweden have less square footage compared to those in Great Britain. However, for larger apartments, there is some variation, with a tendency for apartments in Great Britain to be smaller than those in Sweden.

It is important to note that these numbers cannot be directly compared since they are based on different measuring standards. Great Britain has a minimum standard requirement, while Sweden reports the average size of apartments. The charts can be analyzed to help understand the issue of decreasing apartment sizes.

Apartments today

According to a summary of building permits in Gothenburg in 2016, several new projects lack the desired quality standards that are in demand in the current housing market. The building permits in Gothenburg for 2016 indicate that a significant majority of apartments, about 62%, are of 1-2.5 r.o.k, likely due to the increasing number of single households (Nylander et al., 2019).

A considerable proportion of these apartments are under 55 square meters, which means that the regulation for privacy within the apartment is less of a concern. The building permits commonly feature open floor plans where the living room and kitchen are connected. Additionally, the common regulation states that there are no requirements for apartments under 55 square meters to have a separate kitchen area. However, for apartments over 55 square meters, the regulation states that it is necessary to be able to separate the living room and kitchen. The requirement stipulates that there must be a wall separating the rooms, and each room must have their own window (Boverket, 2022).

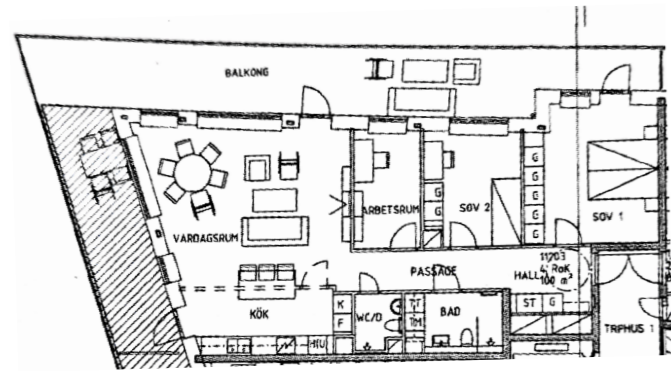

Floor plan | 4 r.o.k | 100 sqm
Sannegården | White Arkitekter | Figure 3.3

The apartment in Sannegården is clearly designed with an open floor plan connecting the living room and kitchen. If you were to divide it as suggested by the dotted line, you would have to divide the kitchen island, resulting in a very small kitchen. As a consequence of the division, the dining area must share space with the living room (Nylander et al., 2019).

One of the smaller rooms is also labeled as a "workspace," indicating that it is too small to be a bedroom. As a result, the apartment that is advertised as a 4-room apartment feels more like a 3,5-room apartment in terms of usability.

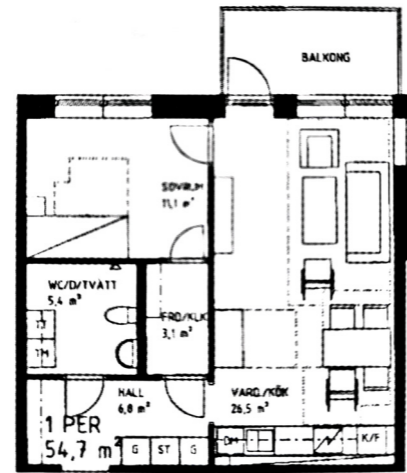

Floor plan | 2 r.o.k | 54,7 sqm
Källtorp | Sweco Architects | Figure 3.4

The 2 r.o.k apartment in Källtorp utilizes the 55 square meter rule by situating the dining area and kitchen in the darker section of the apartment, while reserving the space by the window for the living room (Nylander et al., 2019).

This type of layout is fully accepted by regulations, but one can question the quality within that law.

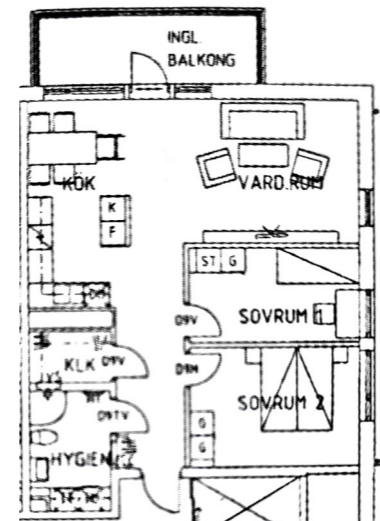

Floor plan | 3 r.o.k | 79 sqm
Angered | Studio Ekberg | Figure 3.5

The apartment in Angered is designed with a clear division between private and public areas, with a hallway leading from the entrance past the bedrooms to the social spaces. However, due to the window positioning, it is a bit challenging to create a clear separation. If the door had been moved slightly to the right, a straight wall could align with the window sill.

Shrinking sizes

When apartments are compacted and designed for maximum area efficiency, it is typical to reduce the size of additional bedrooms to the minimum possible. As a consequence, the flexibility of the apartment is diminished as the room can only be used as a bedroom. Another unique quality is found in apartments that have an extra toilet. For apartments accommodating five people or more, an additional toilet is required. In a 3 r.o.k apartment, having an extra toilet is considered an added bonus. The extra toilet is only required to include a toilet and sink, but having space for an additional shower is considered a quality feature (Nylander et al., 2019).

In Roberts-Hughes' (2011) study, the issue of decreasing apartment sizes in Great Britain is discussed as a problem, leading to inadequate furnishability and insufficient social space for parallel activities in certain rooms. This trend can also be observed in current Swedish housing design, where developers often prioritize area efficiency rather than spaciousness when creating new apartments.

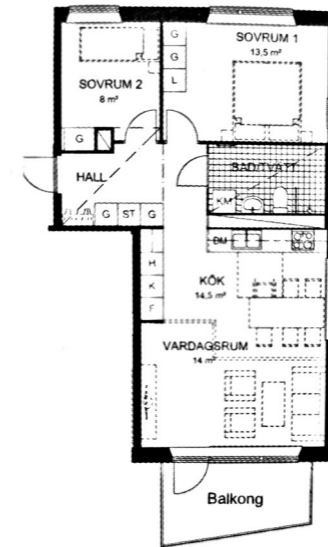

Floor plan | 3 r.o.k | 65 sqm | Järnbrott
Arkitekterna Krook och Tjäder | Figure 3.6

The compact design of the apartment in Järnbrott has resulted in limited options for furnishing the small bedroom, with only one possibility for placing the bed due to the swing of the door and storage placement, which is under the window. Moreover, if the proposed division between the kitchen and living room were to be implemented along the dashed line, it would result in irregularly shaped rooms and the living room would appear much smaller (Nylander et al., 2019).

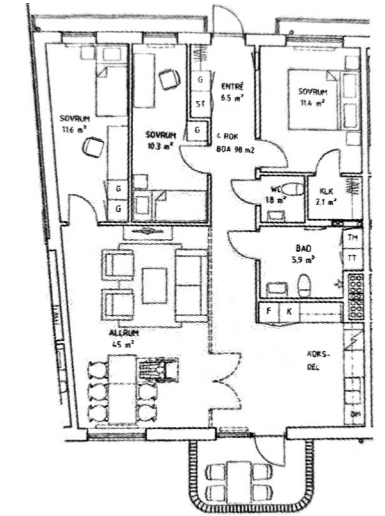

Floor plan | 4 r.o.k | 98 sqm | Brämaregården
Bornstein Lyckefors Arkitekter | Figure 3.7

The apartment in Brämaregården is designed with spaciousness for the social areas. Without the potential wall separating the kitchen from the living room, the bathroom door unfortunately opens into the living room instead of the hallway. All bedrooms are situated with windows facing the access balcony, which somewhat affects the sense of privacy in the bedrooms. Despite the generous floor area, the elongated shape of the two individual bedrooms makes them difficult to furnish (Nylander et al., 2019).

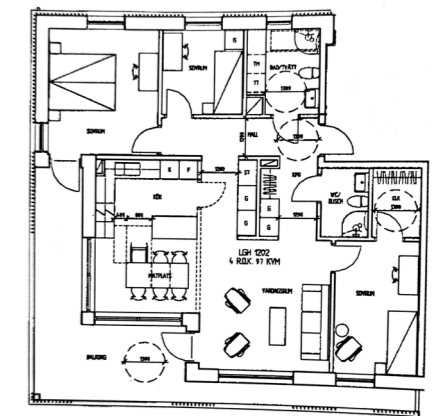

Floor plan | 4 r.o.k | 97 sqm | Skintebo
T+E Arkitekter | Figure 3.8

The family apartment in Skintebo has many qualities. Daylight from three directions, a master bedroom with direct access to the generous balcony and a spacious single bedroom with its own walk-in closet. The dining area is situated in a bright location with a corner window. The living room can easily be separated and has access to the balcony. Circular movement is possible both in the hallway and on the balcony. Finally, both of the two bathrooms have enough space for a shower, making family life much more convenient (Nylander et al., 2019).

Comparison of similar apartments

The apartment at Brämaregården is similar to the one at Skintebo in terms of size, it's even one square meter bigger. However, due to their differences in facade directions the apartments are given totally different layout and qualities. Brämaregården is a double-sided apartment accessible from an access balcony whilst Skintebo is a corner apartment that features three facade directions.

Skintebo includes design attributes such as axially and various choices of circular movement, while Brämaregården only has axially. Regarding the balcony, Skintebo has a large space, partly retracted from the facade that is sheltered from the weather versus Brämaregården has a more boxed-like, smaller balcony attached to the facade.

The master bedroom in Skintebo lacks wardrobes and storage possibilities and one of the single bedrooms is of the smaller scale. The master bedroom in Brämaregården has the quality of a walk-in closet and the two single bedrooms are quite spacious regarding the area, however the long and deep shape of the two rooms makes it a bit narrow, dark and hard to furnish. Additionally, all of Brämaregården's bedrooms face the access balcony, compromising privacy.

Even if Brämaregården is bigger, it only has one shower. Skintebo features two bathrooms with the quality to take a shower in any of them. Skintebo even has a lot more storage possibilities, thus located in the hallway. The storage in this apartment creates a centerpiece that promotes circular movement. Both of the apartments include spacious kitchens, but the living room in Brämaregården can be a bit cramped if the suggested wall should be implemented, additionally that would result in a very long corridor from the entrance to the social spaces.

Conclusions

Concluding the findings in the current building permits, many of the examples lack common design attributes or qualitative features. The ability to separate the kitchen from the living room isn't always met. As mentioned earlier, bedrooms towards an access balcony have formerly been viewed as a negative feature, despite this, it is currently common with that type of design. Lack of facade area results in smaller apartments that don't have the same requirements as larger, unfortunately they are losing out on natural light in the kitchen and dining area. Smaller sizes of rooms in general affect furnishability.

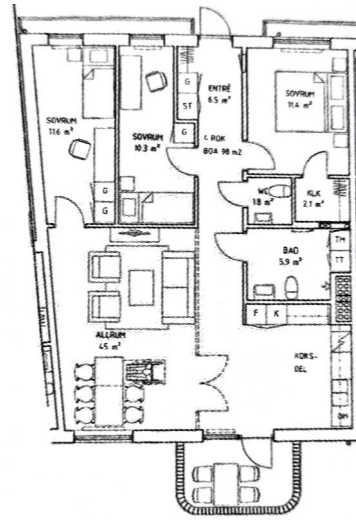

Floor plan | 4 r.o.k | 98 sqm | Brämaregården
Bornstein Lyckefors Arkitekter | Figure 3.7

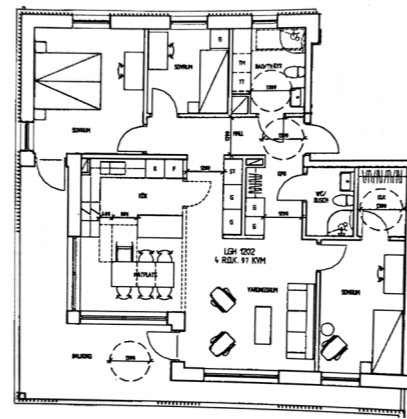

Floor plan | 4 r.o.k | 97 sqm | Skintebo
T+E Arkitekter | Figure 3.8

The balcony as a quality

The outdoor area continues to grow as one of the most important aspects when looking for a new home. A common roof terrace and a private balcony increases the ability to experience the outdoors in a residence that doesn't include the ordinary garden.

How the balcony is located in the apartment also has an impact on the use and feeling of the balcony. Typically, balconies are added to the facade as box-like attachments without any design or further weather protection. According to Nylander (Caldenby & Hallemar, 2020), an integrated balcony is seen as a quality and creates a visual connection between different rooms in the apartment. The ability to look out from one room through the balcony and into another room in the residence is a desirable quality. However, it is an aspect that is often overlooked in modern construction. The housing project in Limhamn is an example of how the design of a balcony can connect indoor rooms. The project even gives examples on how to provide privacy protection from shared access balconies.

In new high-density housing projects, the attention given to balconies is tied to the target group and payment capacity, resulting in a clear polarization. This is particularly evident in small apartments where balconies are increasingly being eliminated or replaced by French balconies. Balconies have become an important quality aspect that ranks high on buyers' lists and is now considered a necessity from a seller's perspective. Granath (Caldenby & Hallemar, 2020) identifies three qualities that characterize interesting new balcony projects: furnishing potential, room quality, and integration with the interior rooms. A modern balcony should be large enough to accommodate dinner parties, designed with the same care for spatial qualities as the interior rooms, and possess factors such as enclosure, climate protection, orientation, privacy, and a pleasant view. These qualities increase the balcony's usability and create an additional room for the residence.

Both the apartments in the projects Alfa and Botanikern are examples of how balconies can be integrated into the building structure and function as an additional room. In Botanikern, the apartment has also been expanded with an additional balcony for extra outdoor space.

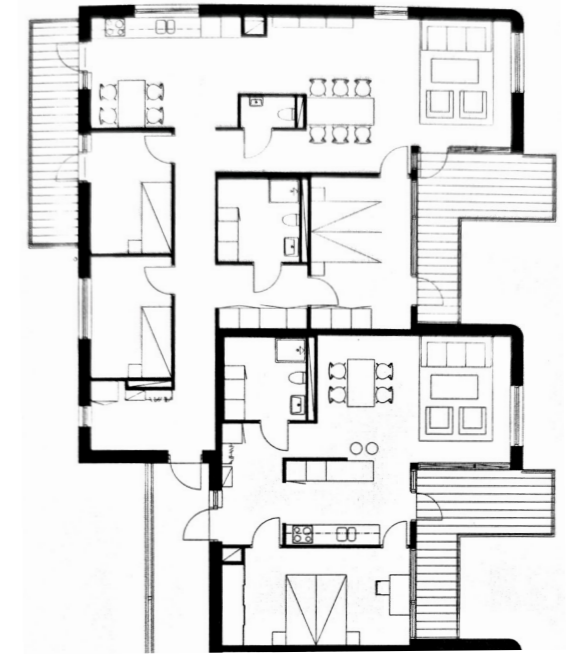

Floor plan | integrated balcony
Limhamn, Malmö | Metro Arkitekter | Figure 3.9



Floor plan | integrated balcony | Alfa
Johanneberg, Gothenburg | Kub Arkitekter | Figure 3.10

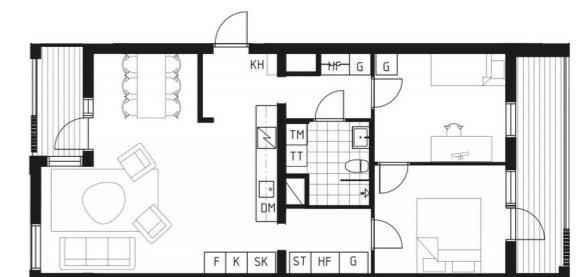

Floor plan | integrated balcony | Botanikern
Rosendal, Uppsala | Axeloth Arkitekter | Figure 3.11

MAB

Following two spreads is an overview and a short summary made by the thesis author of MAB Manual for analysis of housing qualities (Granath & Nylander, 2023). Translations made by the thesis author.

(original titel: MAB Manual för analys av bostadskvaliteter).

APARTMENT (Bostaden)

COURTYARD (Bostadsgården)

BUILDING (Byggnaden)

The analysis involves 28 different qualities distributed on three main levels: apartment, courtyard and building. The aspect apartment consists of 12 qualities, while the courtyard and building each consists of 8 qualities. The apartment level is further divided into three sublevels, each with four assessed qualities. Belonging to the analysis is a manual that briefly outlines the purpose of the assessment, provides definitions of each quality and describes the requirements for approval.

The analysis is based on a point system where one point is assigned to each approved quality. If some qualities are missing, that subject is given a score of zero. These points are gathered in an excel spreadsheet, where the final result is presented as a grade of either failed, bronze, silver, or gold, depending on the number of points.

The underlying principle of MAB is that a poorly designed apartment costs as much to build as a well-designed one, and by using MAB, communication between client, architect and developer are easier maintained and therefore it's easier to achieve a high-quality apartment.

All illustrations on following two spreads is connected to MAB and belongs to the MAB compendie and its authors (Granath & Nylander, 2023). | Figure 3.12

Functionality

1. Area efficiency
2. Technical rationality
3. Furnishable area
4. Potencial to stay

Spaciousness

5. Axiality
6. Movement
7. Shape of room
8. Flexibility

Atmosphere

9. Facade directions
10. Balcony
11. Designed daylight
12. Dark area

This thesis only uses the level of apartment for assessment, due to the investigation being on floor plans of the apartment and its qualities rather than qualities in the courtyard or the building. Therefore, the courtyard and building are not a part of further investigation and will not be summarized or explained further. MAB is used in the thesis as both an evaluation method for discussion and comparison as well as design guidelines for the following design proposal.

Functionality

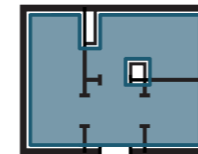

1. Area efficiency (Yteffektivt)

The living area in an apartment with area efficiency is below the limit indicated in the chart below. The limit is set 5% lower than the national average area recorded over a three-year period from 2018 to 2020.

Apartment type (r.o.k (room and kitchen))	Average Area from SCB 2018-2020 (sqm)	Limit (sqm)
1 r.o.k	32,5	30,9
2 r.o.k	52,4	49,7
3 r.o.k	74,3	70,6
4 r.o.k	93,7	89,0
5 r.o.k+	115,9	110,1

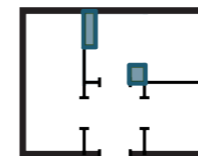

2. Technical rationality (Teknisk rationalitet)

Technical rationality means that all shafts are gathered together and easy to access. They should be able to reach directly from the staircase but if that is not possible, it's still approved as long as they are gathered together in the apartment.

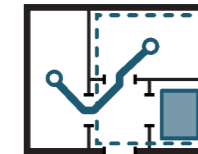

3. Furnishable area (Möblerbar yta)

The furnishable area is a free area where the resident can put various furniture without interfering with the communication area.

Communication area is where the resident needs to walk to reach a room or access fixed furniture such as kitchen cabinets, wardrobes or else.

For approval, the total furnishable area in the apartment should be at least 50% of the total square meters of the apartment.

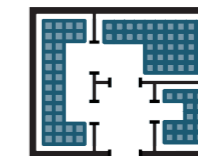

4. Potential to stay (Potencial för kvarboende)

Potential to stay refers to the capability to stay in your home when someone is getting older and the living conditions change. The attribute consists of three parts: bedroom capacity, spatial proximity, and functional autonomy.

1. Bedroom capacity: One bedroom with a minimum space of 300x310 cm for free furnishable space.
2. Functional autonomy: Caretakers don't need to pass the kitchen, living room or the healthy person's bedroom.
3. Spatial proximity: Short distances, a minimum of 6 meters between entrance, bedroom, WC and storage.

Spaciousness



Axiality refers to the possibility to move along an axis. The requirement for approval is a minimum of two movement axes. The axis should go through three rooms, one or two of the rooms can be a terrace or balcony as shown in the examples below.

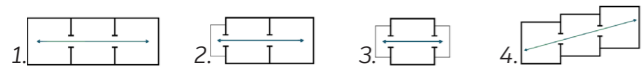

The requirement for shape of room refers to the room being of geometric form and contains a possibility to easily perceive the room. A well formed room can be described with a rectangle.



Movement in the apartment should be continuous without having to stop or go back. The circulation movement could be around a centerpiece, between several rooms or through a terrace/balcony.

The movement should be at least one of the five examples below.

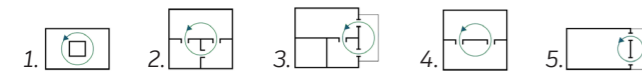

Flexibility is divided into five different points where three of them are needed for approval.

1. General rooms: A minimum of two general rooms. (A general room is at least 13 sqm big with a minimum of a 3,3 m long wall).
2. Parallelism: Parallel communication (the rooms in the apartment are available to reach individually without walking through one to reach another).
3. Variable number of rooms: The number of rooms can vary by adding a wall (the added room should be at least 7 sqm big and have a window).
4. Connections between rooms: A minimum of two openings in a general room/another room than kitchen and living room.
5. Autonomous room: A room that could be rented out, with a minimum of 4 m from the entrance and at least have a measure of 300x310 cm free furnishable space.

Atmosphere



The apartment has facades with windows that face at least two directions. A minimum of 45 degrees angle between the facades is requested for an approved score.



Designed daylight refers to elements where the natural light is affected and creates a quality. To approve this subject at least one architectural element of the four; balcony, corner window, bay window or beveled window niches is required. Two balconies can also meet the demand.

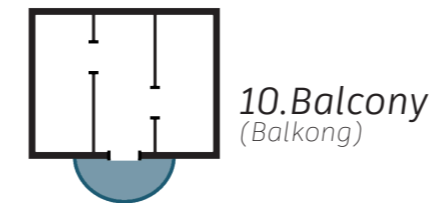

The resident should have direct access to a private balcony, terrace, or patio that belongs to the residence.



Dark areas are spaces where there is no visual contact with the outside, thus no natural light. The combined area of such spaces should not exceed 15% of the total area of the apartment.

04. CASE STUDY

Analysis of apartments

The following four apartments are from the project "Klassrummet" in Mölndal by Liljewall and Skanska. They have been evaluated according to the MAB criteria list, (Granath & Nylander, 2023). A brief introduction will outline any issues with the apartments, some examples of possible change, and then they will be analyzed based on the sublevels Functionality, Spaciousness, and Atmosphere.

The results will be presented in a chart format as the example below. All assessed qualities will conclude the aspect grades for each sublevel. These sublevels will then be combined to create a total grade. Finally, the case study will conclude with an assessment of the findings and their impact on the apartment.

TOTAL GRADE	ASPECT	ASPECT GRADE	TOTAL QUALITY	R/O		
silver	FUNCTIONALITY	gold	3	area efficiency	1	
				technical rationality	1	
				furnishable area	0	
	SPACIOUSNESS	silver	2		potential to stay	1
					axiality	1
					movement	0
					shape of room	1
					flexibility	0
					facade directions	0
	ATMOSPHERE	bronze	1		balcony	1
					designated daylight	0
					dark area	0

Evaluation chart | MAB | Figure 4.1

Cases

The apartments are picked due to relevance in the project and to show variation in the type of floor plan and size.

Apartment A
R.o.k.: 2
Area: 45 sqm
Type: one-sided

Apartment C
R.o.k.: 3
Area: 77 sqm
Type: double-sided

Apartment B
R.o.k.: 3
Area: 73 sqm
Type: corner

Apartment D
R.o.k.: 4
Area: 92 sqm
Type: double-sided

Apartment A

2 r.o.k | 45 sqm

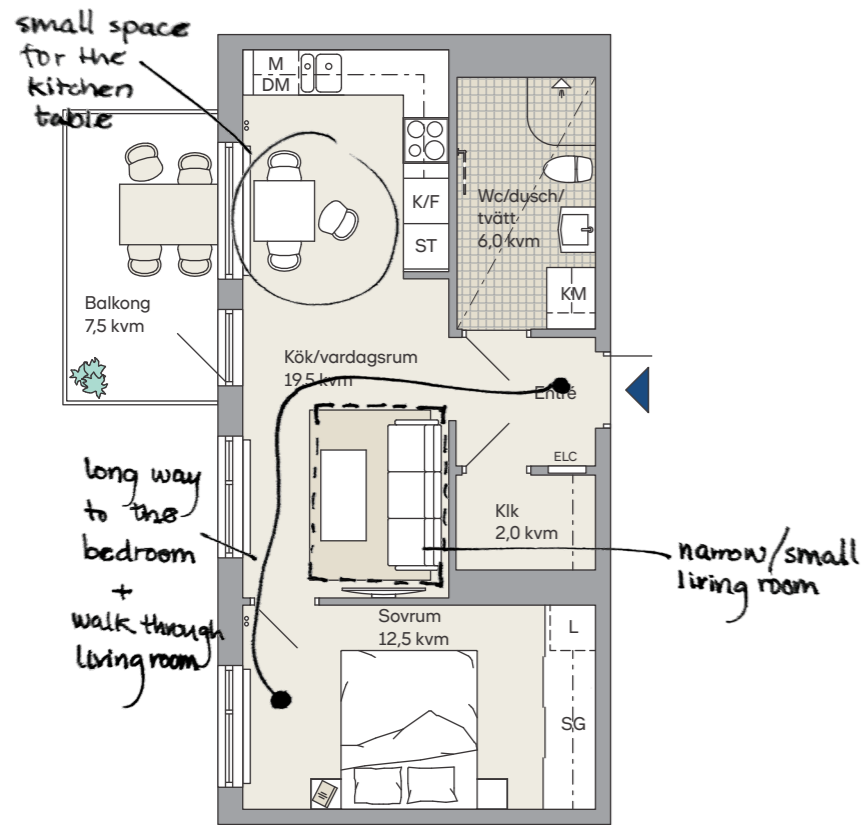

Figure 4.2 1100

Evaluation

The apartment's facade is only exposed on one side, leading to only one direction of incident light. The spatial layout of the rooms is well-organized, although they are somewhat compact. The kitchen has limited space, accommodating only a small table, and the living room's function as a pathway to the bedroom restricts furnishing options, making the area appear cramped.

Potential solution

A potential solution to resolve this issue, is to transform the closet into a walk-through closet for the bedroom. This alteration would result in a more spacious living room with more options for furnishing.

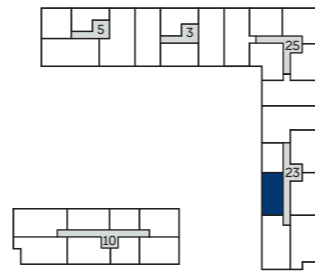
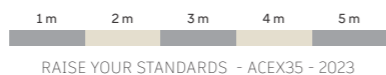
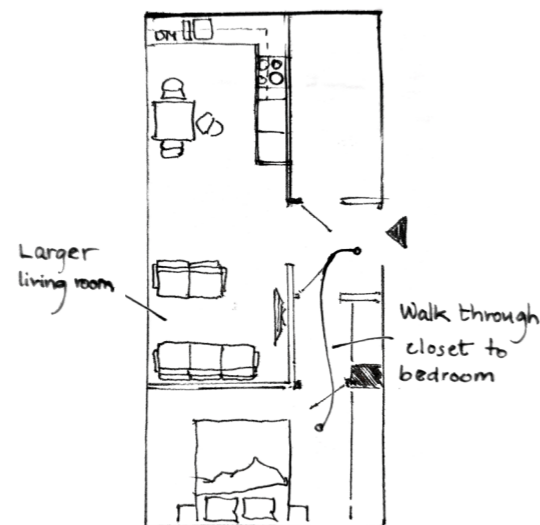

Grade according to MAB

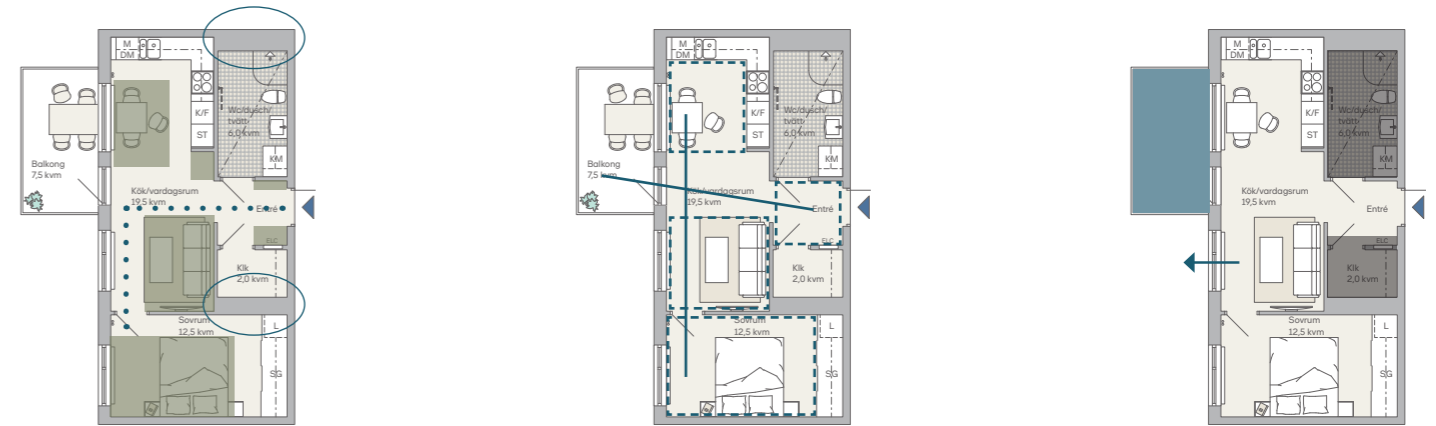

1200

Functionality

- area efficiency
- technical rationality
- furnishable area
- potential to stay

Spaciousness

- axuality
- movement
- shape of room
- flexibility

Atmosphere

- facade directions
- balcony
- designed daylight
- dark area

TOTAL GRADE	ASPECT	ASPECT GRADE	TOTAL	QUALITY	1/0
bronze	FUNCTIONALITY	silver	2	area efficiency	1
				technical rationality	1
				furnishable area	0
				potential to stay	0
	SPACIOUSNESS	silver	2	axuality	1
				movement	0
				shape of room	1
				flexibility	0
	ATMOSPHERE	bronze	1	facade directions	0
				balcony	1
				designed daylight	0
				dark area	0

Grade

The apartment has an overall rating of bronze. It earns a silver rating in functionality for achieving *area efficiency* and *technical rationality*, and in spaciousness for *axuality* and *shape of room*. However, the atmosphere category only achieves a bronze rating due to its only point for the balcony, resulting in an final bronze rating.

Comments

In general, designing a well-proportioned one-sided apartment can be challenging. Achieving good lighting conditions and providing sufficient facade for the desired number of windows can be quite difficult. While the apartment in this case is well-structured, the communication pathways result in small usable areas which affects the furnishability.



Apartment B

3 r.o.k | 73 sqm

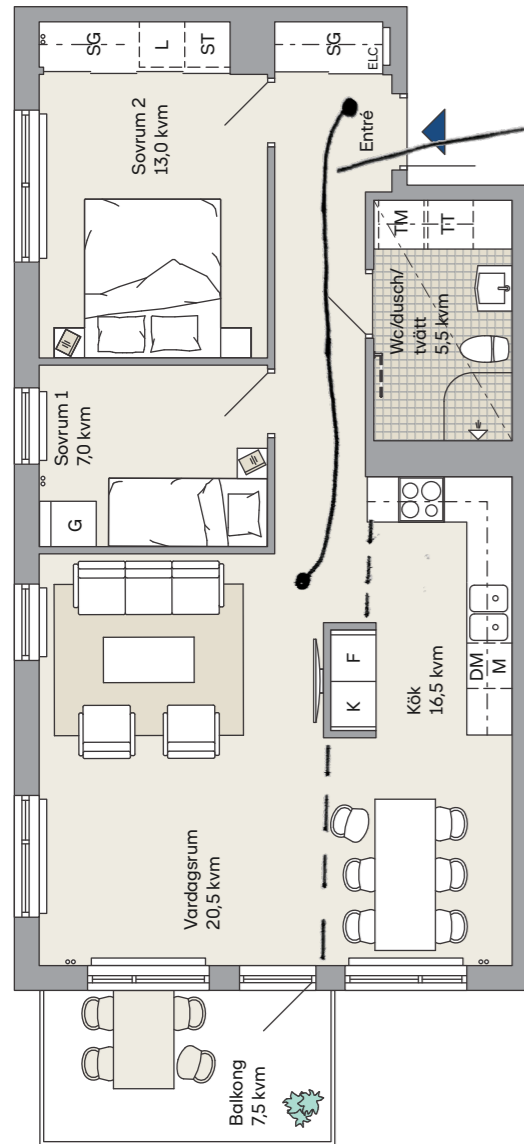
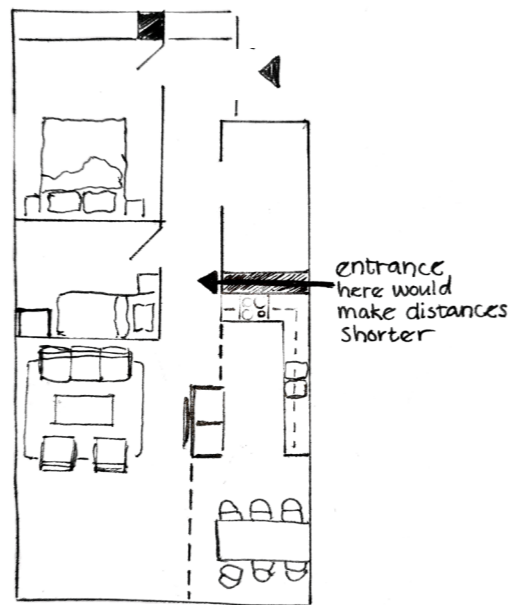

Figure 4.3 1:100

Long corridor creating dark area

Potential solution

An improvement would certainly be to move the entrance to reduce the length of the hallway. Otherwise it's a good layout, which is also proved by having received the grade gold in MAB.



Evaluation

The apartment generally has a good distribution of rooms with well-proportioned spaces. The bedroom is conveniently situated near the entrance and the bathroom, allowing for private use without disrupting the rest of the living space. However, due to the placement of the entrance, the hallway may feel a bit long and like a corridor.

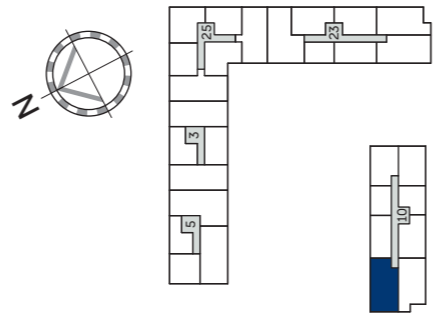
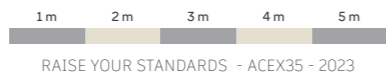

Grade according to MAB

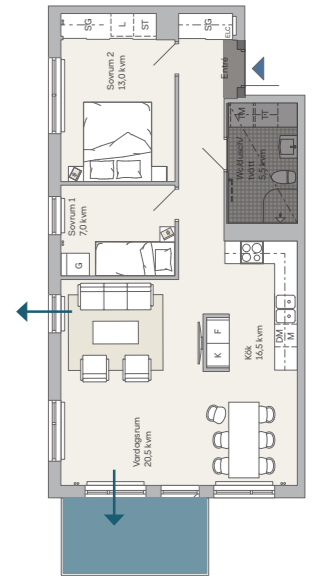
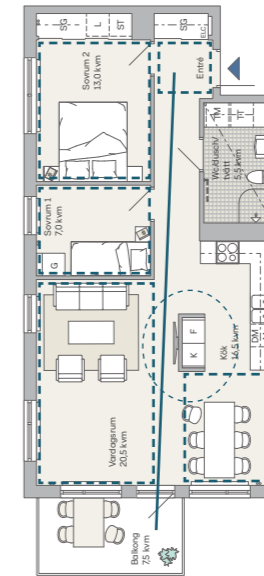
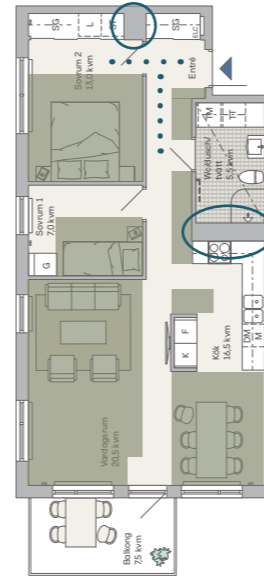

1:200

Functionality

- area efficiency
- technical rationality
- furnishable area
- potential to stay

Spaciousness

- axially
- movement
- shape of room
- flexibility

Atmosphere

- facade directions
- balcony
- designed daylight
- dark area

TOTAL GRADE	ASPECT	ASPECT GRADE	TOTAL	QUALITY	1/0
gold	FUNCTIONALITY	gold	3	area efficiency technical rationality furnishable area potential to stay	0 1 1 1
	SPACIOUSNESS	gold	3	axially movement shape of room flexibility	0 1 1 1
	ATMOSPHERE	gold	3	facade directions balcony designed daylight dark area	1 1 0 1

Grade

The apartment has received an overall rating of gold. In terms of functionality, it achieves *technical rationality*, *furnishable area*, and *potential to stay*. Regarding spaciousness, it achieves *movement*, *shape of room*, and *flexibility*. As for atmosphere, it meets criteria such as *facade directions*, *balcony*, and a lower proportion of *dark area*.

Comments

In contrast to all the other apartments, this one is a corner unit. The corner location provides an exclusive opportunity for spacious and bright social areas with light coming from two directions. Additionally, it is possible to reduce long distances while still maintaining the individual rooms' functionality.

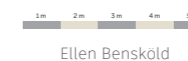

Apartment C
3 r.o.k | 77 sqm

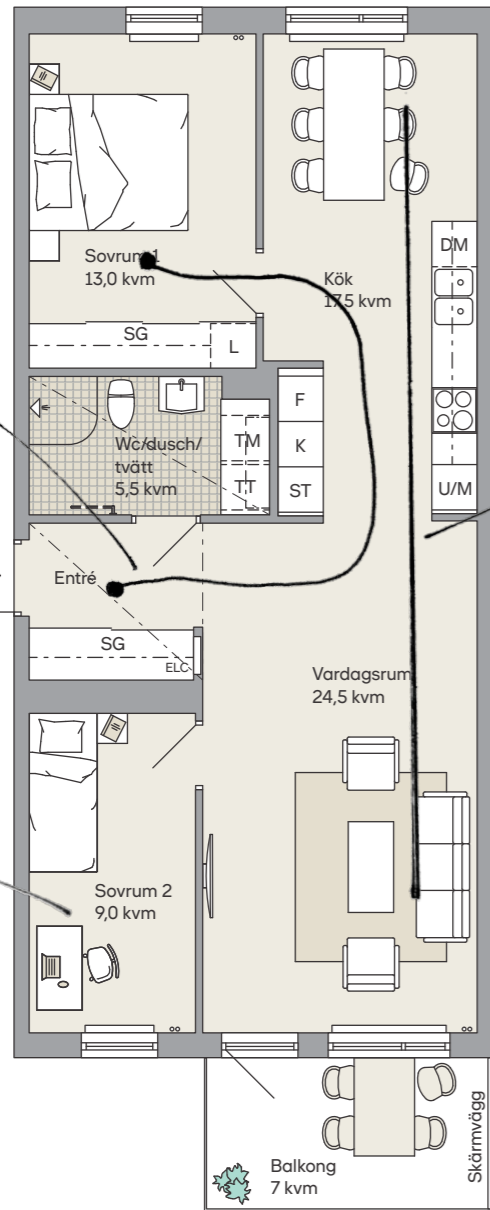

long distance to master bedroom + walk through the kitchen

long distance between the social spaces

wardrobe?

Figure 4.4 1:100

Evaluation

The apartment generally has long distances between rooms due to the apartment being a double-sided unit that stretches 14 meters deep. The social areas are spread out, with the kitchen serving as an intermediary space and passageway. The master bedroom is far from both the entrance and the toilet, and to reach it, you need to walk through the kitchen.

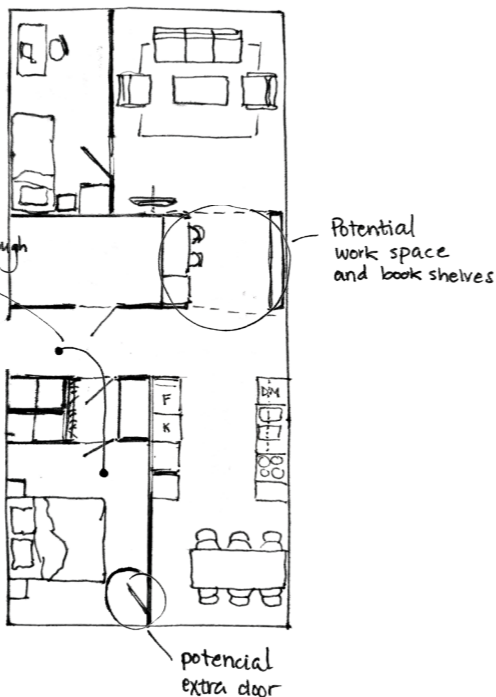

Potential solution

To improve the layout, a possible solution is to relocate the master bedroom and kitchen. The entrance to the bedroom could be a walk-through closet. This implies that the kitchen only serves as a passage to the dining area. This would add an additional area in the middle of the apartment that would serve as a passage and could be utilized as a workspace with a table and a bookshelf. Unfortunately, this change would however result in a smaller living room.

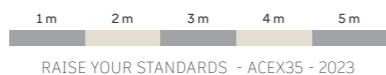

Grade according to MAB

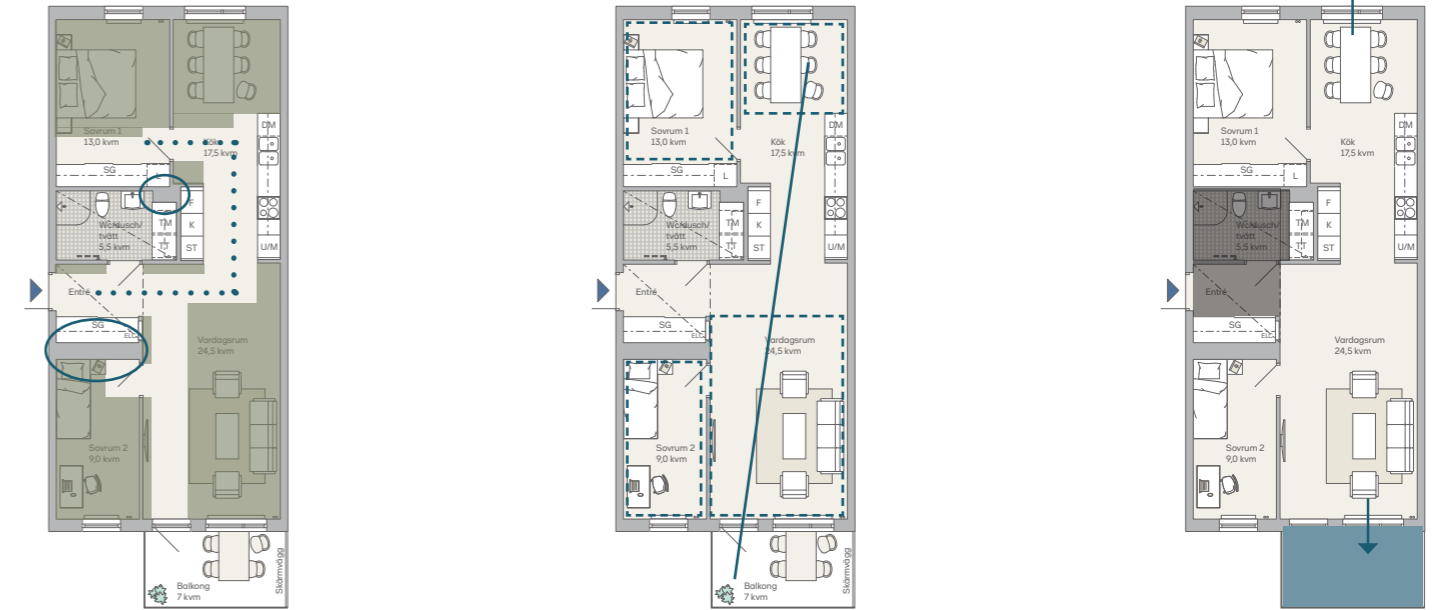

1:200

Functionality

- area efficiency
- technical rationality
- furnishable area
- potential to stay

Spaciousness

- axuality
- movement
- shape of room
- flexibility

Atmosphere

- facade directions
- balcony
- designed daylight
- dark area

TOTAL GRADE	ASPECT	ASPECT GRADE	TOTAL	QUALITY	1/0
bronze	FUNCTIONALITY	bronze	1	area efficiency	0
				technical rationality	1
				furnishable area	0
	SPACIOUSNESS	bronze	1	potential to stay	0
				axuality	0
				movement	0
	ATMOSPHERE	gold	3	shape of room	1
				flexibility	0
				facade directions	1
				balcony	1
				designed daylight	0
				dark area	1

Grade

The apartment has a final rating of bronze. It receives only one point each in both functionality and spaciousness for *technical rationality* and *shape of room* respectively. However, in the final category, atmosphere, it receives a gold rating due to meeting several qualities such as *facade directions*, *axuality*, and minimal *dark area*.

Comments

The apartment's significant challenge lies in its depth. Double-sided apartments benefit from having light from opposite sides, but they cannot be too deep, as this would create a dark middle part. Planning the middle can be challenging and may lead to it being a communication pathway. In this case, the apartment could have been less deep and wider to provide more facade area.

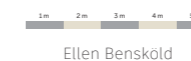

Apartment D

4 r.o.k | 92 sqm

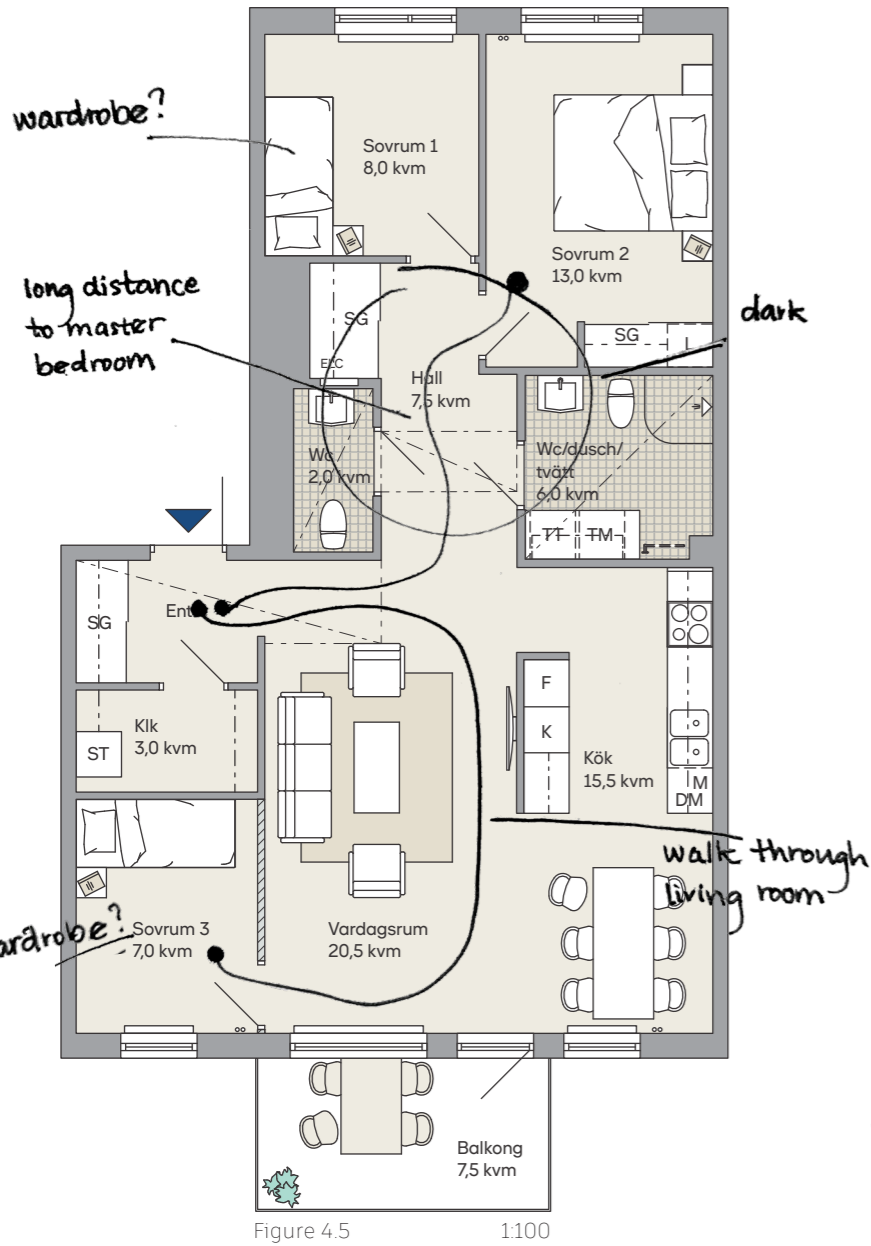

Potential solution

A possible improvement to the layout of this apartment would be to switch the position of the entrance and the small toilet. This would make the entrance and hallway more centrally located, reducing the distances in the apartment. The door to the extra bedroom would be moved towards the toilet, creating a duo that potentially could be rented out. With the new layout, the living room would also be less disturbed.

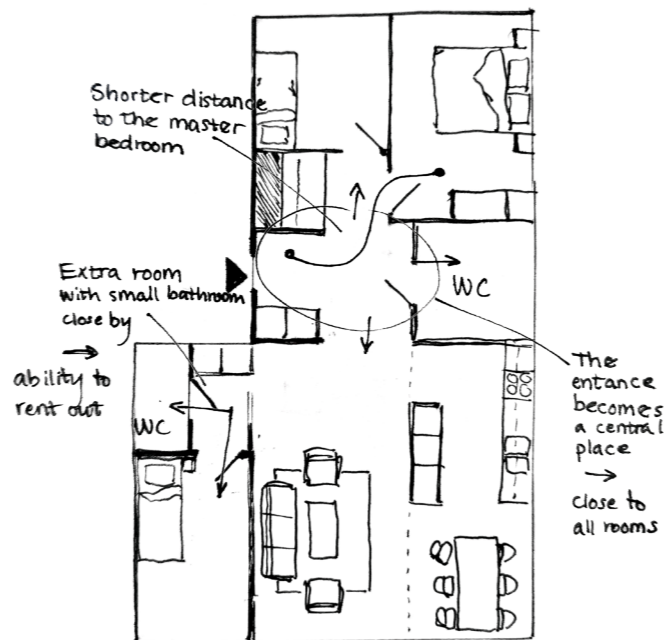

Grade according to MAB

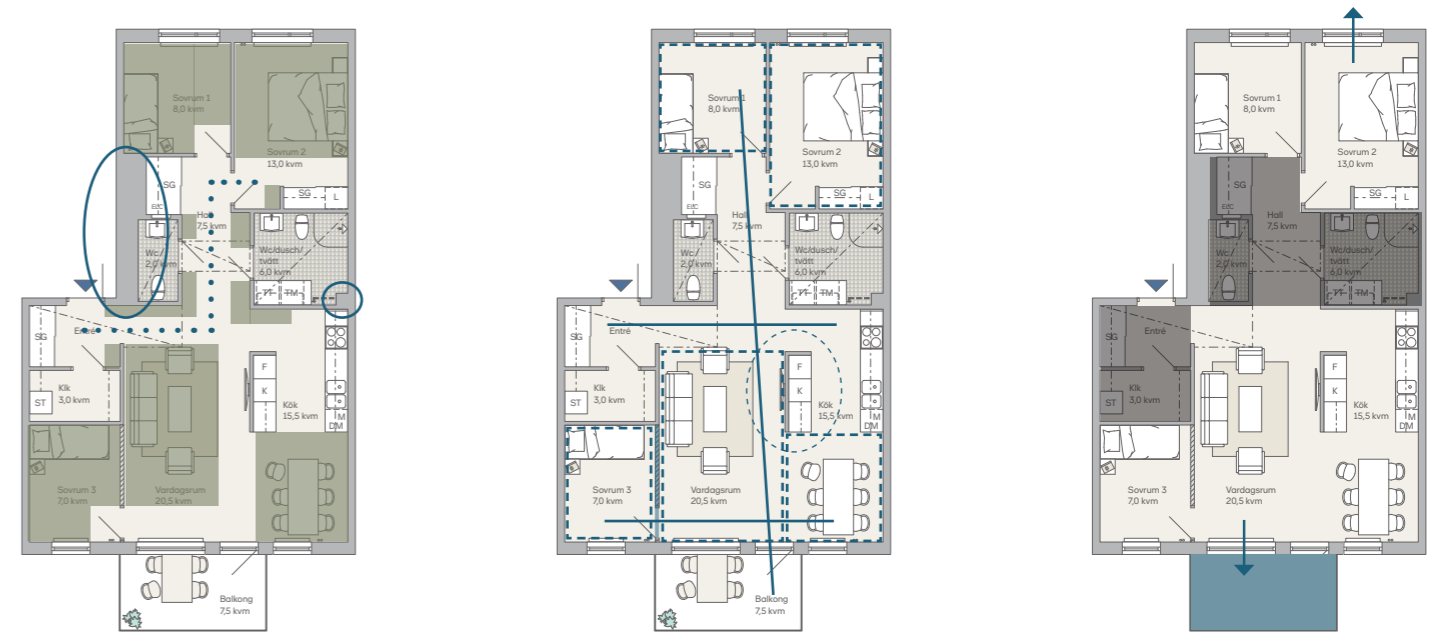

Functionality

- area efficiency
- technical rationality
- furnishable area
- potential to stay

Spaciousness

- axiality
- movement
- shape of room
- flexibility

Atmosphere

- facade directions
- balcony
- designed daylight
- dark area

TOTAL GRADE	ASPECT	ASPECT GRADE	TOTAL	QUALITY	1/0
silver	FUNCTIONALITY	bronze	1	area efficiency technical rationality furnishable area potential to stay	0 1 0 0
	SPACIOUSNESS	gold	3	axiality movement shape of room flexibility	1 1 1 0
	ATMOSPHERE	silver	2	facade directions balcony designed daylight dark area	1 1 0 0

Evaluation

This apartment, much like the previous double-sided apartment, has long distances between rooms due to the deep building structure. The distance from the entrance to the master bedroom is considerable, and the two bathrooms, along with the hallway, create a dark middle part within the apartment. To access the additional bedroom, one must pass through the living room, which restricts the furniture placement.

Grade

When it comes to functionality, the apartment receives a bronze rating for *technical rationality*. In terms of spaciousness, it earns a gold rating for *axiality*, *movement*, and *shape of room*. As for the atmosphere, it is rated silver due to the qualities such as *facade directions* and *balcony*. In summary, all the different aspect grades conclude into the final grade being silver.

Comments

Similar to the previous apartment, this apartment would benefit from being less deep. However, due to its larger size, it offers more facade area, which allows for better lighting despite its depth. This is reflected in the MAB's rating, now being silver instead of bronze as in the former apartment. A slightly different layout could alleviate the dark central area and reduce the long distances.

Conclusion

Apartment A 2 r.o.k | 45 sqm

TOTAL GRADE	ASPECT	ASPECT GRADE	TOTAL	QUALITY	1/0
bronze	FUNCTIONALITY	silver	2	area efficiency technical rationality furnishable area potential to stay	1 1 0 0
	SPACIOUSNESS	silver	2	axiality movement shape of room flexibility	1 1 1 0
	ATMOSPHERE	bronze	1	facade directions balcony designed daylight dark area	0 1 0 0

5 total points

Apartment B 3 r.o.k | 73 sqm

TOTAL GRADE	ASPECT	ASPECT GRADE	TOTAL	QUALITY	1/0
gold	FUNCTIONALITY	gold	3	area efficiency technical rationality furnishable area potential to stay	0 1 1 0
	SPACIOUSNESS	gold	3	axiality movement shape of room flexibility	1 1 1 1
	ATMOSPHERE	gold	3	facade directions balcony designed daylight dark area	1 1 1 1

9 total points

Apartment C 3 r.o.k | 77 sqm

TOTAL GRADE	ASPECT	ASPECT GRADE	TOTAL	QUALITY	1/0
bronze	FUNCTIONALITY	bronze	1	area efficiency technical rationality furnishable area potential to stay	0 1 0 0
	SPACIOUSNESS	bronze	1	axiality movement shape of room flexibility	0 0 1 0
	ATMOSPHERE	gold	3	facade directions balcony designed daylight dark area	1 1 0 1

5 total points

Apartment D 4 r.o.k | 92 sqm

TOTAL GRADE	ASPECT	ASPECT GRADE	TOTAL	QUALITY	1/0
silver	FUNCTIONALITY	bronze	1	area efficiency technical rationality furnishable area potential to stay	0 1 0 0
	SPACIOUSNESS	gold	3	axiality movement shape of room flexibility	1 1 1 0
	ATMOSPHERE	silver	2	facade directions balcony designed daylight dark area	1 1 0 0

6 total points

Compilation

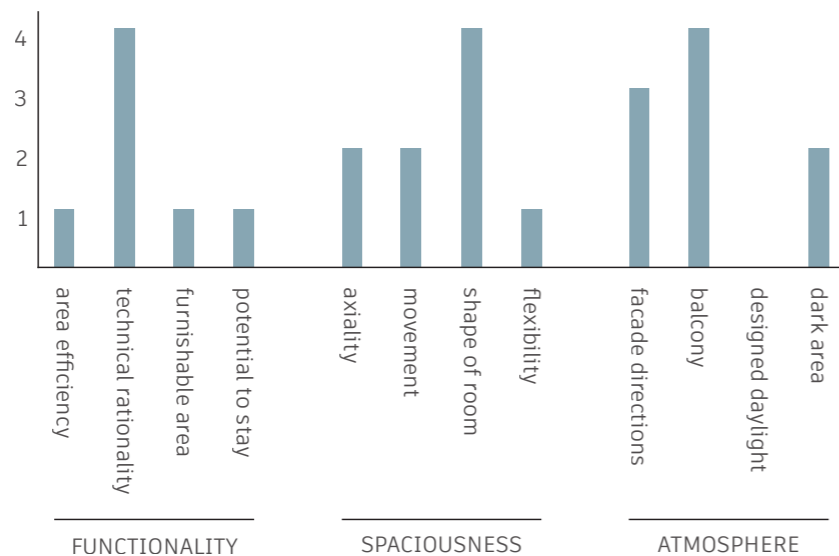

In conclusion, all the surveyed apartments have received points for the attributes *technical rationality*, *shape of room* and *balcony*. However, *designed daylight* is completely missing. The remaining characteristics vary between the apartments, but there is a clear lack of *area efficiency*, *furnishable area*, *potential to stay* and *flexibility*.

Some of the mentioned aspects contradict each other, for example, *flexibility* requires a certain amount of space, which is often cut in more compact and area efficient apartments.

The chart summarizes the results of the case study and provides an overview of the achieved qualities in the different aspects. The analysis of the chart reveals that there is a relatively even distribution of achieved qualities among the three aspects. However, it is worth noting that there is a slightly lower score on functionality in comparison to the other aspects. Overall while the apartments generally score well, there is room for improvement in all three aspect groups.

Negative qualities:

- Dark middle part
- Long distances
- Poor furnishability
- Pass-through rooms between bedroom and bathroom
- Difficulty separating kitchen and living room
- No possibilities for long-term living
- Limited potential for changes in the apartment, poor flexibility

Positive qualities:

- All apartments have access to a balcony
- Half of the cases
- Possibility for circular movement
 - Axiality
 - Short distance between bedroom and toilet

Summarise of case study

All different types of apartments have their respective opportunities and challenges. In a one-sided apartment, it can sometimes be difficult to create well-proportioned rooms while also ensuring adequate communication space without compromising the furnishability. The challenges change with the apartment type and in a double-sided apartment, avoiding the dark middle and long distances between rooms can be more of a challenge than the communication paths.

Furthermore, as seen in the corner unit, this type of apartment allows for more opportunities in flexibility in size, as there are no predetermined parameters, such as in the double-sided or one-sided apartment.

The MAB grade system shows that a one-sided apartment (Apartment A) got the same grade as a double-sided apartment (Apartment C), but looking at the specific aspect grades, none of them were the same.

The MAB method has worked well in this study to position the apartments and create a platform where they can be discussed, compared and evaluated.

These four apartments provide a starting point for the continued investigation as well as the upcoming design proposal. All the different apartment typologies will be investigated further with new design proposals.

05. REFERENCE PROJECTS

1. Floor plan | 3 rok | 75 sqm | Figure 5.1
2. Perspective | building - square | Figure 5.2

The purpose of analyzing reference projects is to find examples that have incorporated the design attributes this thesis focuses on, furthermore the examples can provide inspiration and spark new ideas to the upcoming design proposal. The three reference projects, Botanikern, Alfa, and Strandparken, are Swedish housing developments situated in Uppsala, Gothenburg, and Stockholm, respectively. These projects have been chosen to serve as sources of inspiration, primarily because of their recognition in several awards and their high-quality floor plans. A central theme among the plans is the incorporation of circular movement, axiality, and attention to materials and details.

Botanikern

Architects: Axeloth Arkitekter
Location: Rosendal, Uppsala
Finished: 2019
Number of apartments: 122
Prize: Uppsala Arkitekturpris 2020

The apartments in this project are designed in a restrained and nature-inspired Nordic style. The main material is a CLT structure with a wooden facade (Axeloth Arkitekter, n.d.).

The building was awarded the "Uppsala Architecture Prize 2020" with the motivation that the building is aesthetically pleasing, well-proportioned and has attractive detailing (Genova, n.d.).

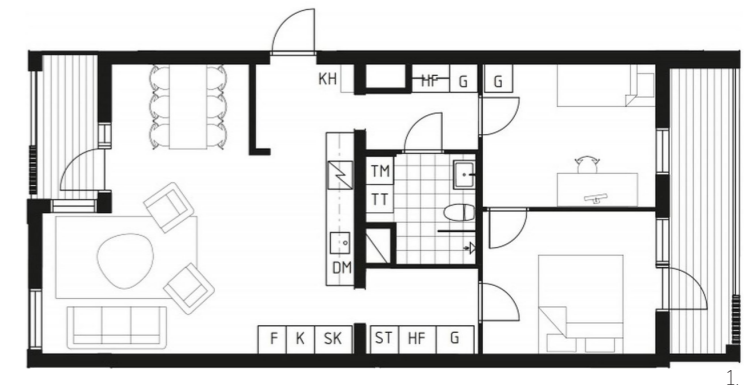

Botanikern's floor plans are thoughtfully designed with attention to axiality, circular movement, and the balance of private and public areas. The balconies are carefully positioned, one of them retracted from the facade to create a buffer connecting inside with outside.





1.

Alfa

Architects: Kub Arkitekter
Location: Johanneberg, Gothenburg
Finished: 2014
Number of apartments: 46
Prize: Best HSB-project 2013–2014

The building received the Best HSB-project award for 2013–2014 based on the harmonious integration of quality and functionality, extending from the urban planning stage to the execution of minute details. The architecture defies the dull and foreseeable norms of modern residential construction, evoking a classical and almost spiritual building tradition (HSB, 2015).

The aim was to create sustainable apartments that blend Nordic elegance with durability, utilizing top-quality materials and paying attention to details, resulting in homes that can withstand fleeting trends. The apartments have been designed with focus on axuality, circulation, and the interplay of private and public spaces. The balconies are positioned away from the facade, generating a private and secluded atmosphere between the apartment and the courtyard (Caldenby et al., 2019).



2.



3.

1. Perspective | south facade | Figure 5.3
2. Perspective | entrance | Figure 5.4
3. Floor plan Alfa | 4 rok | 95 sqm | Figure 5.5
4. Floor plan Strandparken | 3 rok | Figure 5.6
5. Perspective | building - square | Figure 5.7
6. Private balcony | exterior material | wood | Figure 5.8
7. Entrance | interior material | wood | Figure 5.9
8. Apartment | interior detail | wooden frames | Figure 5.10

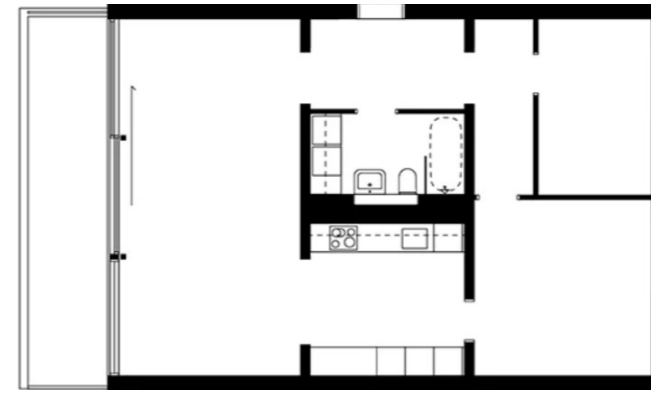

4.

Strandparken

Architects: Wingårdhs
Location: Sundbyberg, Stockholm
Finished: 2014
Number of apartments: 31
Prize: Stockholms Stadsmiljöpris 2014
Nomination: Träpriset 2016

The building was nominated due to its strong character in terms of volume, placement, and facades, making it one of the top projects in modern Swedish residential construction. The apartments are thoughtfully designed, providing beautiful daylight and featuring finely crafted wooden details (Svenskt Trä, n.d.).



6.

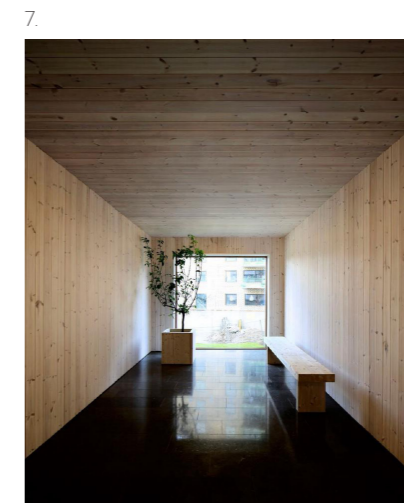

7.



8.



5.

The buildings consist of a solid wooden frame and adorned with wooden facades, giving them a sturdy and distinctive appearance. Wooden flooring, doors, window frames, and details in the kitchen and bathroom are always incorporated into the design. The housing units are thoughtfully structured, with features such as axuality, circular movement, and a well-defined partition between the public and private areas of the apartment. In addition, both the balcony and common entrance have a distinctive wood design (Caldenby & Hallemar, 2020).

1. Botanikern | floor plan analysis | Figure 5.1
2. Alfa | floor plan analysis | Figure 5.5
3. Strandparken | floor plan analysis | Figure 5.6

Analysis of reference projects

The floor plans of the reference projects are evaluated with MAB and briefly analyzed by assessing design attributes that enhance the living quality in the apartment, such as having access to a balcony, axially, potential for circular movement, room organization and private versus public zones in the apartment.

Botanikern

This double-sided apartment has balconies on both sides, with the larger balcony offering more privacy thanks to its connection to the bedrooms. The apartment's room layout creates three distinct zones: private, semi-private and public which makes it easier for parallel activity in the apartment. The apartment features both axially and the possibility for circular movement through the bedrooms, creating a feeling of spaciousness.

According to MAB, this apartment has the grade of gold.

Alfa

In contrast to the other two references, Alfa has a brick facade and features a corner apartment with three facade directions. The apartment has all bedrooms collected together as a block with close access to the bathrooms. The inner corridor functions as a buffer between private and public areas in the apartment, promoting parallel activity. The living room and kitchen are spacious and are easily separated from each other, while still maintaining access to the balcony from both rooms. Circular movement is possible both around the bathroom and through the balcony. The apartment also incorporates axially in several directions. Moreover, the apartment boasts the detail of a corner window for enhanced natural light and panoramic views.

According to MAB, this apartment has the grade of gold.

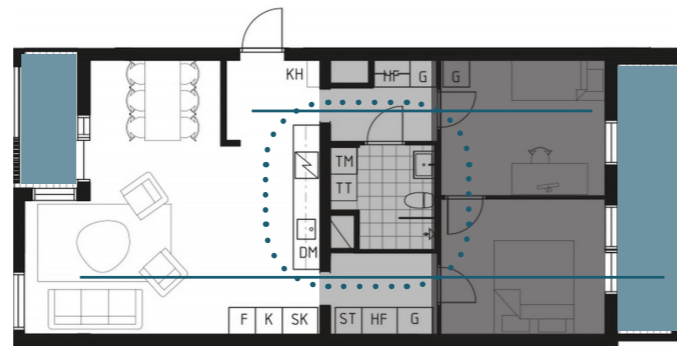
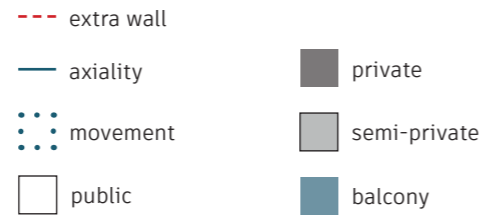

1.

TOTAL GRADE	ASPECT	ASPECT GRADE	TOTAL	QUALITY	1/0
gold	FUNCTIONALITY	silver	2	area efficiency technical rationality furnishable area potential to stay	0 0 0 0
	SPACIOUSNESS	gold	3	axially movement shape of room flexibility	0 0 0 0
	ATMOSPHERE	gold	3	facade directions balcony designed daylight dark area	0 0 0 0



2.

TOTAL GRADE	ASPECT	ASPECT GRADE	TOTAL	QUALITY	1/0
gold	FUNCTIONALITY	silver	2	area efficiency technical rationality furnishable area potential to stay	0 0 0 0
	SPACIOUSNESS	gold	3	axially movement shape of room flexibility	0 0 0 0
	ATMOSPHERE	gold	4	facade directions balcony designed daylight dark area	0 0 0 0

Strandparken

Similar to the previous double-sided apartment, this one also features bedrooms clustered together for easy access to the bathroom. However, in this case, the entrance area is more clearly defined and enclosed. The kitchen is positioned in the core of the apartment, creating a walk-through layout that results in a slightly darker space. Despite this, the glass facade facing the balcony makes it challenging to separate the kitchen and living room. On the other hand, the abundance of natural light streaming into the room is a major benefit.

According to MAB, this apartment has the grade of gold.



3.

TOTAL GRADE	ASPECT	ASPECT GRADE	TOTAL	QUALITY	1/0
gold	FUNCTIONALITY	silver	2	area efficiency technical rationality furnishable area potential to stay	0 0 0 0
	SPACIOUSNESS	gold	3	axially movement shape of room flexibility	0 0 0 0
	ATMOSPHERE	gold	3	facade directions balcony designed daylight dark area	0 0 0 0

Conclusions

Botanikern and Strandparken have taken a new approach to building construction, utilizing high-quality wood as their primary material choice for both the structure and facade, employing CLT construction. The two projects differ in terms of their facades, with Strandparken featuring wooden shavings, while Botanikern has wooden panels. Both projects have gained attention due to their innovative use of wood.

The double-sided apartments in both buildings are similar in size and layout, featuring the same qualities such as axially, circular movement and room organization that promote parallel activities. These buildings are noteworthy due to their materiality, and they inspire the thesis design proposal in different ways even if they are using the same material. Botanikern's exterior more closely aligns with the intended design proposal, while Strandparken features excellent interior wooden detailing.

Moving on to the corner apartment at Alfa, the floor plan, layout of the rooms, and the retracted balcony are the main features that inspire the thesis proposal. By clustering the bedrooms and bathroom together, a more private zone is created versus the public zone with the living room and kitchen, allowing for privacy and the possibility of hosting a bigger amount of guests by visually connecting the social spaces.

Based on the MAB analysis, all three apartments achieved a gold rating. While they all received a silver rating in the sublevel of *Functionality*, overall, the apartments exhibit a high level of architectural quality.

When developing the design proposal, several of the displayed features will be taken into consideration. This includes the different types of circular movement that can be incorporated, such as through the bedrooms, corridor or balconies. The positioning of the axes and the visual connection between the living room and kitchen will also be carefully considered. Furthermore, the organization of rooms, as private and public blocks, will be integrated as a feature in the final design proposal. Additionally the examples of how to integrate the balcony will also be further investigated, since that is important for its comfort and respective use.

However, it should be noted that the reference apartments mentioned in this context are more spacious than the intended apartments in the thesis proposal. Rather than copying these projects, the aim is to draw inspiration from their qualitative features.

06. DESIGN STRATEGIES



Research findings

The research reveals a general lack of design attributes in contemporary housing architecture, and suggests that area-efficient apartments contribute to this ongoing trend due to the fact that some attributes require more space. As a result of the housing shortage, newly developed apartments are usually smaller to accommodate more units in the same area. However, smaller apartments do not necessarily have to sacrifice quality. Area-efficient apartments that make good use of the available space can still achieve architectural quality.

Seven design strategies have been selected, including area efficiency, to demonstrate that architectural quality is achievable even in area-efficient residences. These strategies aim to enhance the quality of the apartment and the living environment in the residence, and will be continuously utilized in the design proposal.

It is not necessary to include and achieve all seven design attributes to create a qualitative apartment, but rather to use them as recommendations to increase further qualities. Certain attributes may be preferable in one situation and not in another, depending on the individual case.

Design strategies

Following seven design attributes will serve as design strategies in the design proposal.

Area efficiency

Area efficiency refers to making the most of the available space in the apartment. This criteria is constrained by the square meter limits in MAB, which will serve as a main framework for the design proposal.

Axiality

Axiality can create a sense of coherence in the apartment and contributes to the feeling of spaciousness. In the design proposal, axiality connects important rooms such as *entrance - social space - balcony*.

Movement

The movement attribute enables the choice of a private or public zone while navigating within the apartment and allows for access points to the balcony from multiple rooms.

Room organization

Organizing the rooms involves the arrangement of various spaces within the apartment. This design strategy will be employed to establish private and public areas in the apartment by gathering the bedrooms and connecting the social spaces.

Material & details

Material and details refer to the materials and finishes used in the apartment, the proposal features wood as main material both in exterior and interior detailing.

Balcony

A balcony is a desirable feature in any apartment, as it provides outdoor space and can create visual connections between different rooms. Designing the balcony to be functional and comfortable can enhance the overall livability of the apartment. In the proposal, the balcony serves as a space creator and typically affects the design of the social areas. It is also incorporated in the exterior design and includes material and details with wooden bars.

Corner window

Incorporating a corner window into the apartment design can offer ample natural light and panoramic views, resulting in a more spacious and open feeling. This design strategy is regarded as a qualitative feature that influences the amount of natural light. It is utilized to create a luxurious and high-quality atmosphere in the apartments.

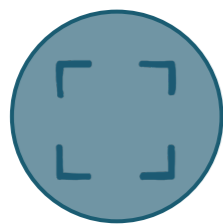

Area efficiency



Axiality

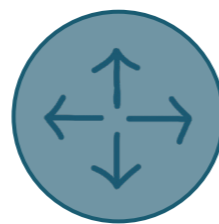

Movement

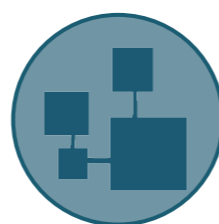

Room organization

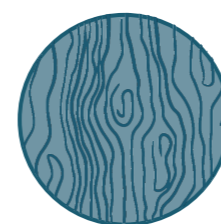

Material & details

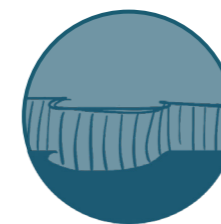

Balcony

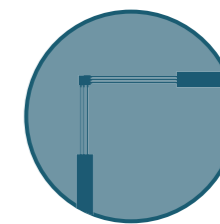

Corner window

07. DESIGN PROPOSAL



1. Project area
2. Site plan | Klassrummet | Mölndal | Figure 7.1
3. Project area | Pedagogen Park

Site

The existing design proposal being investigated in the thesis is the housing project “Klassrummet” located at the site Pedagogen Park in Mölndal. The site is currently developed by the company Skanska.

The main focus of the thesis is to investigate architectural quality in the residence, therefore there will be no changes to the existing placement of buildings, volumes or site analysis. The current building programme will also work as a frame for the thesis investigation and design proposal.

Skanska

Skanska is a construction and project development company with focus on both the design and construction part in their projects. The company was founded in 1887 and has since then expanded and currently operates in ten countries in Europe and the USA (Skanska, n.d.).

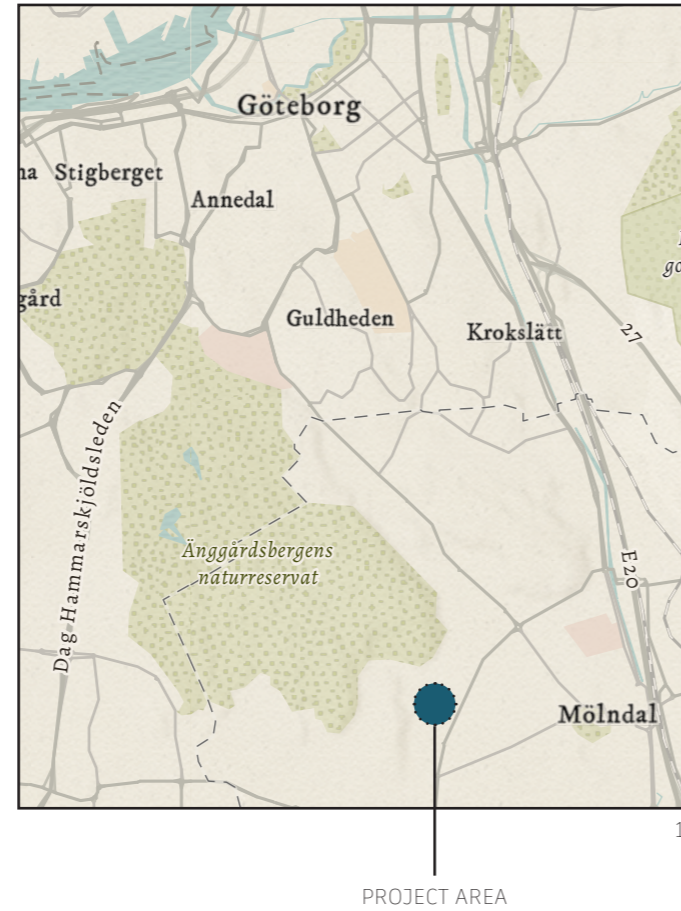
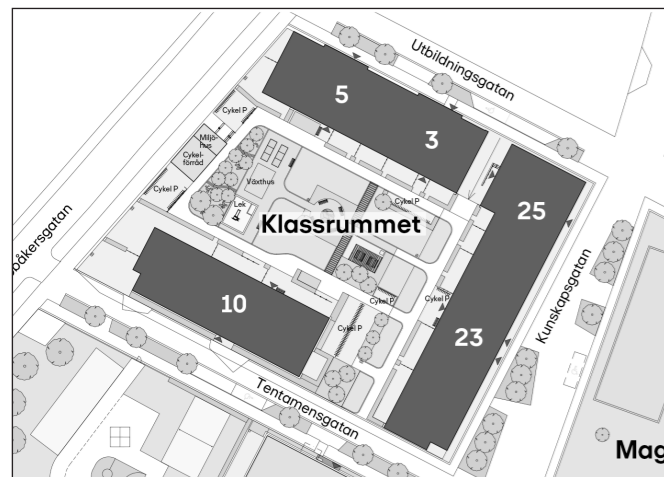

Project Klassrummet

Number of buildings: 2
Building type: Lamella
Number of staircases: 5
Depth: 14 meters
Height: 5-6 floors + 4 floors

Ownership type: housing association
Apartment type: operative apartment
Total number of apartments: 137
Rooms: 1-5 r.o.k.
Apartment sizes: 26-128,5 sqm

All numbers retrieved from Skanska, 2022.



1. Perspective | existing volume
2. Facade | south-east
3. Facade | north-east
4. Facade | north-west
5. Facade | south-west
6. Facade material | brick
7. Facade material | plaster
8. Floor plan analysis | 1:500
9. Section figure of building | 1:2000
10. Section AA-AA | 1:500
11. Section A-A | 1:500
- 1-11. Figure 7.2

Existing project

The existing proposal for Klassrummet consists of two volumes, one bigger and one smaller. The facades feature yellow and off-white plaster as well as red brick.

Moving forward, the smaller building will be excluded from further investigations, and the thesis will only address the corner lamella.

The building is a corner lamella with four internal staircases. The structure has been planned with a high degree of space efficiency, featuring numerous apartments and a simple geometric layout. The building includes different apartment types such as the corner apartment, the double-sided apartment and several one-sided apartments. The wide range of apartment sizes

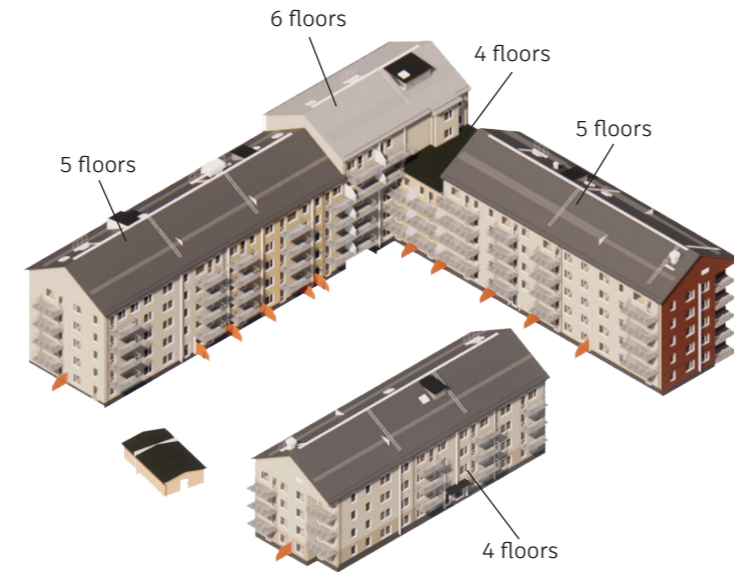

1.

reflects on the present building market and caters to the needs of individuals and families alike, promoting a diverse community. The building itself is quite deep, 14 meters, which makes it a necessity to position the staircases in the middle to fill up the dark core in the building. The straightforward geometry, exterior balconies, and limited number of staircases result in cost-efficient production and create a significant amount of marketable space.



2.



3.



4.



5.



6.



7.

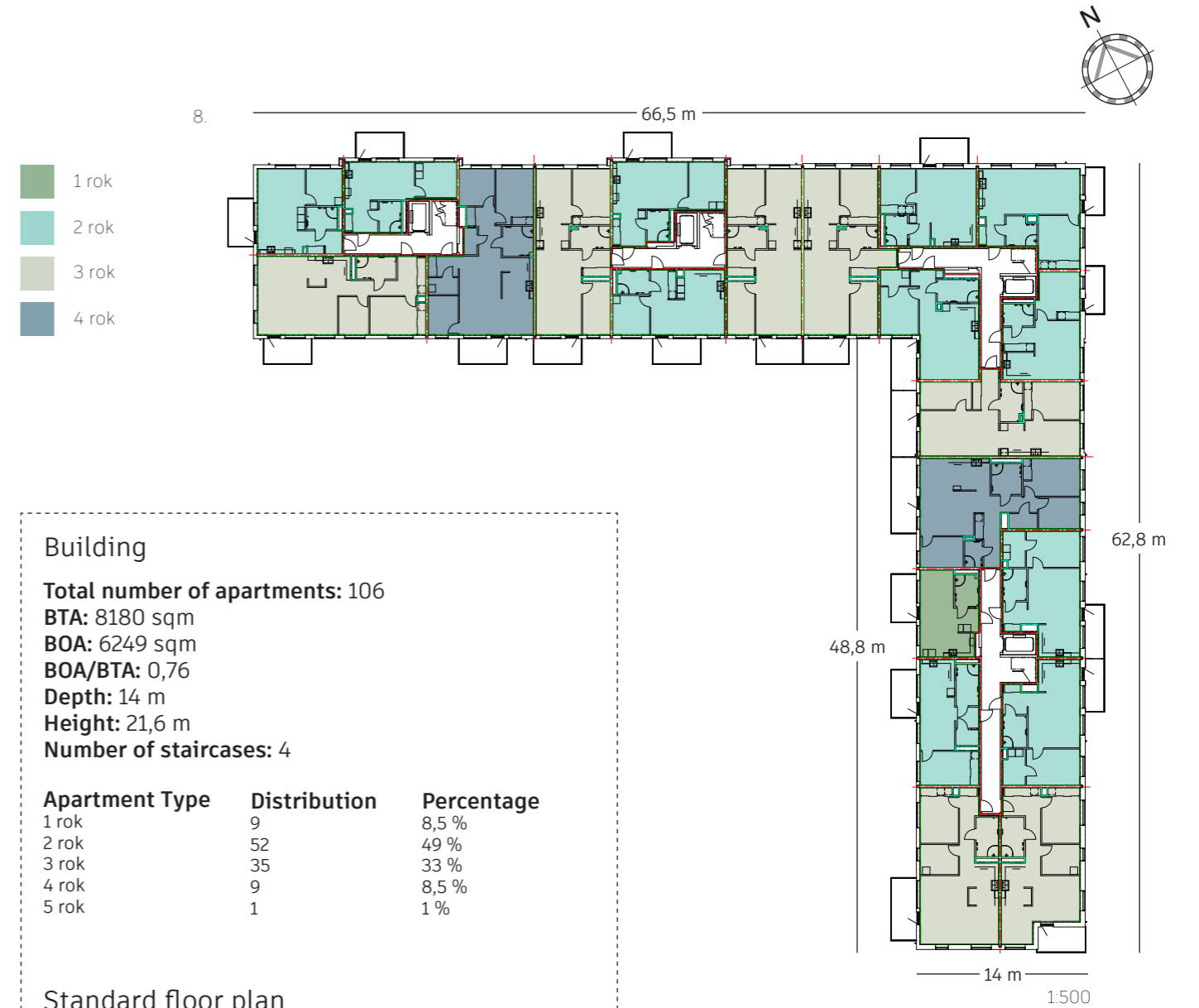

Building

Total number of apartments: 106
BTA: 8180 sqm
BOA: 6249 sqm
BOA/BTA: 0,76
Depth: 14 m
Height: 21,6 m
Number of staircases: 4

Apartment Type	Distribution	Percentage
1 rok	9	8,5 %
2 rok	52	49 %
3 rok	35	33 %
4 rok	9	8,5 %
5 rok	1	1 %

Standard floor plan

Number of apartments on standard floor plan: 21
Sqm of standard floor plan: 1614 sqm
Sqm of balconies on standard floor plan: 164 sqm

Apartment Type	Distribution
1 rok	1
2 rok	11
3 rok	7
4 rok	2
5 rok	0

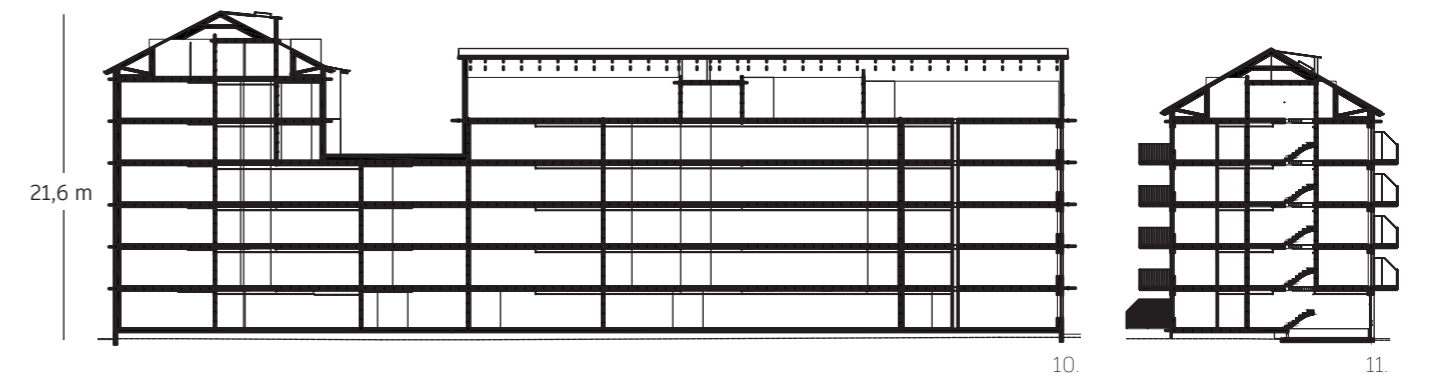
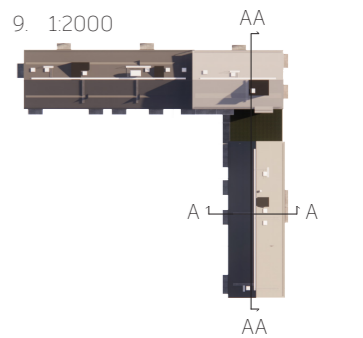

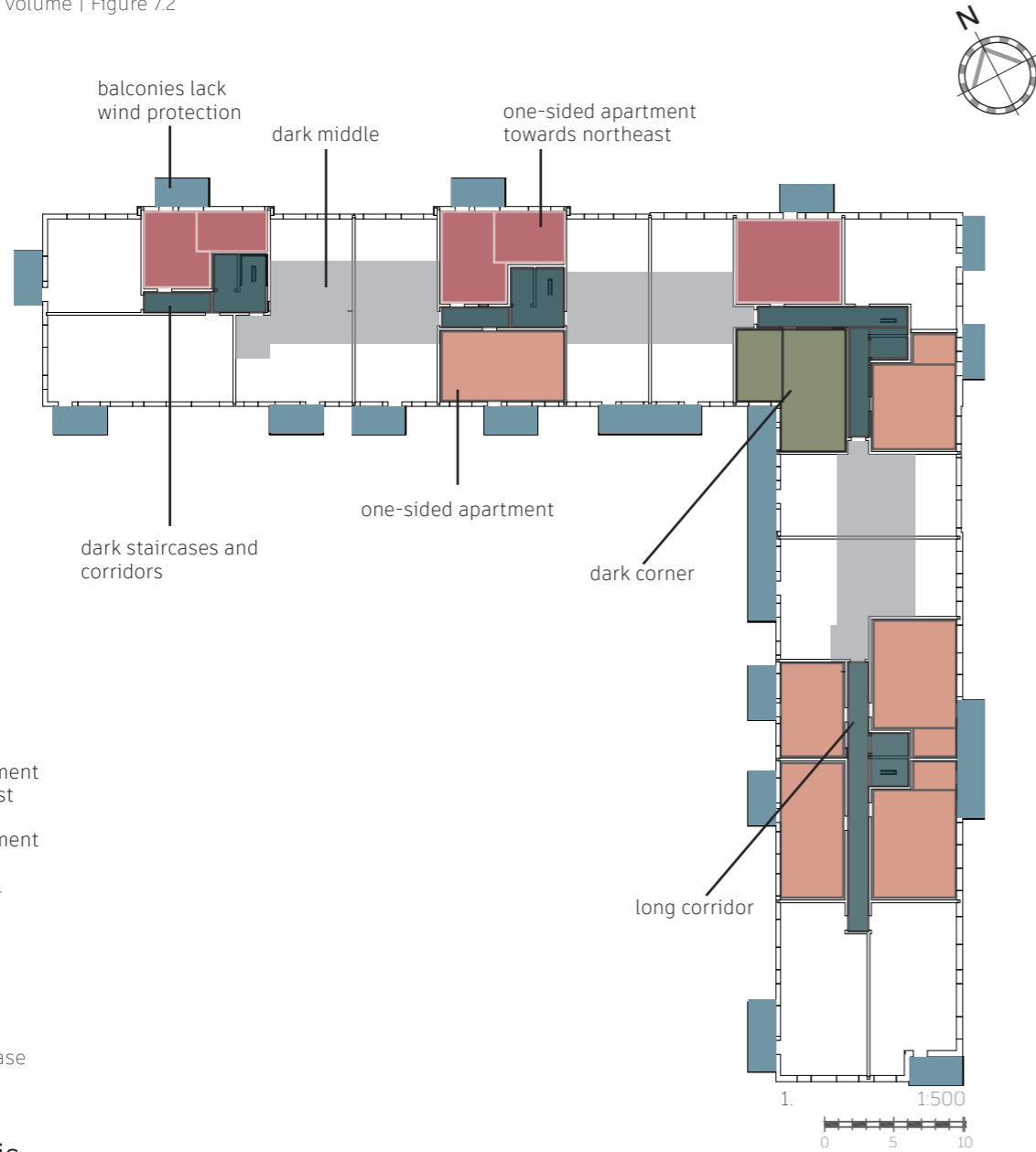

Building analysis

In a building this big, that only has as few staircases as four, it's inevitable to end up with a lot of one-sided apartments. Usually these apartments offer less architectural qualities than other apartment types due to the reduced opportunities for natural light and overall poor light conditions. Further these apartments are often quite narrow which challenges a desired room organization and the ability of options to furnish. Unfortunately a third of these units are also oriented towards the northeast direction, resulting in minimal exposure to sunlight. However, in this project the one-sided apartments constitute 43% of the residences and will therefore be assessed and explored further.

The depth of the building means that double-sided apartments become very deep. Due to the depth, it's difficult to create apartments without a dark middle part and long distances between the different internal rooms.

All of the staircases are located in the core of the building, which makes them dark. In addition, there are only a few staircases for the amount of apartments, creating long and dark internal corridors. The placement of the staircases and the long corridors create an unpleasant experience for the residents since you have no access to natural light.

The box-shaped balconies are located on the outside of the facade, which makes them exposed to the weather and without protection from onlookers. As they are currently located some of them even suffer from less privacy since they are facing each other.

The inner corner has become a very dark and unpleasant apartment since it doesn't have a lot of space for windows and where there are windows, the balcony above shadows them.

Design process

The sketches illustrate the process of the building's layout, including the design strategies, in the distribution of staircases, apartments and balconies.

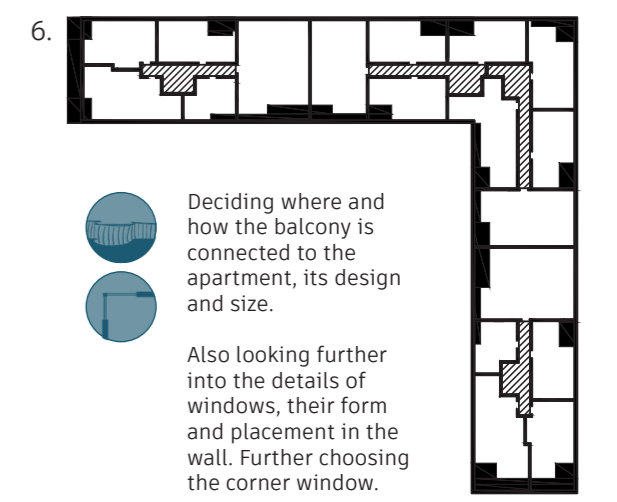
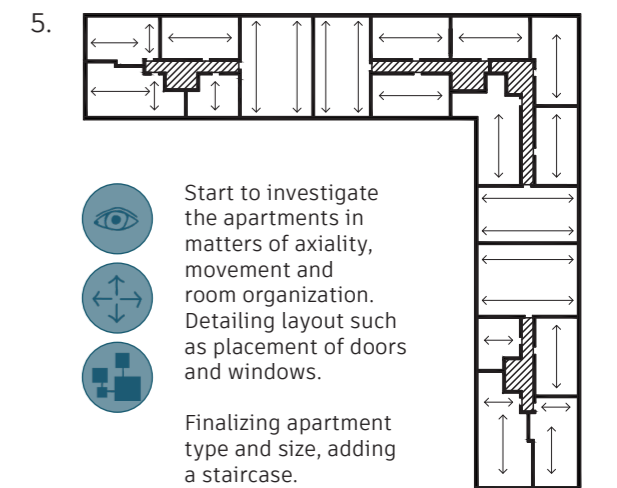
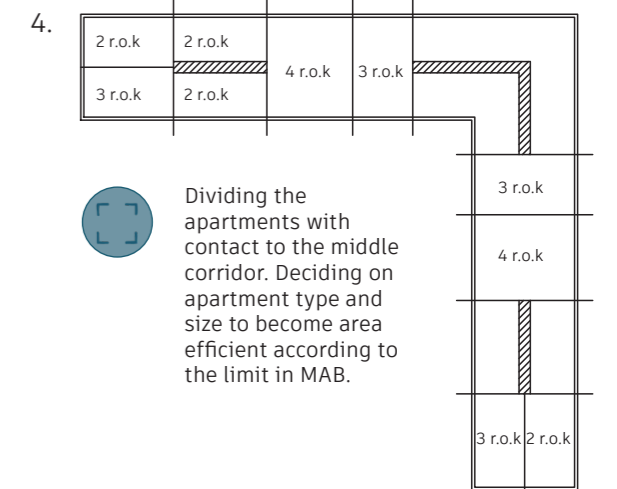
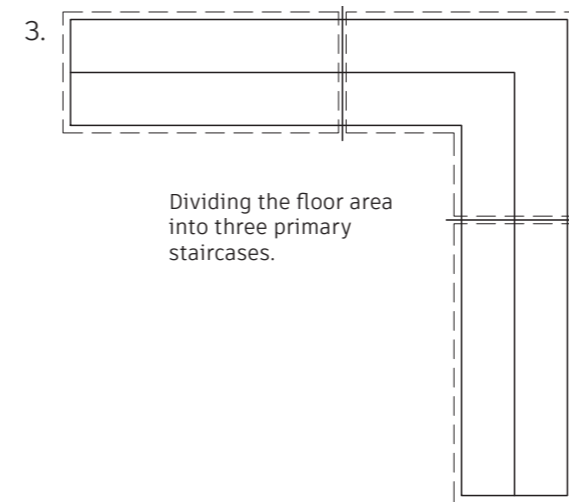
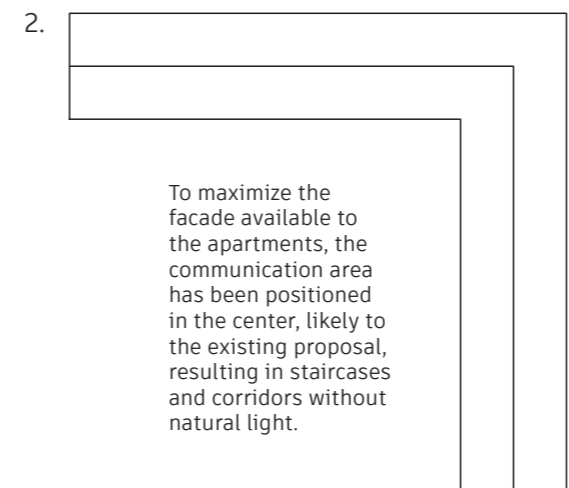
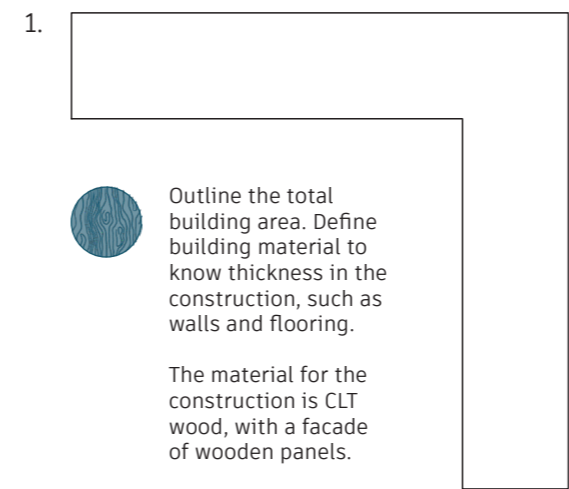
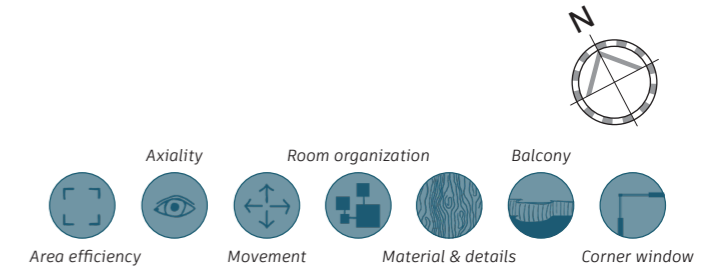

- 1. Section figure of building | 1:1000
- 2. Axonometry
- 3. Section B-B | 1:500
- 4. Section BB-BB | 1:500

- 5. Facade | north-east
- 6. Facade | south-west
- 7. Facade | north-west
- 8. Facade | south-east

Building | Sections | Facades

The proposed design is a wooden building constructed with cross-laminated timber and a facade made of vertical wooden panels. The set back balconies create a sheltered outdoor space and lend a playful touch to the building's expression. The orangery and rooftop terrace are spacious enough to provide a large area for festive gatherings with many people or a pleasant cup of tea with a neighbor.

Similar to the original proposal, the volume ranges from four to six floors, with a passage on the ground facing northeast and a generous opening in the southeast facade that results in a rooftop terrace and a shared communal building. The height of the building is at highest 23,5 meter with a width of 14 meters.

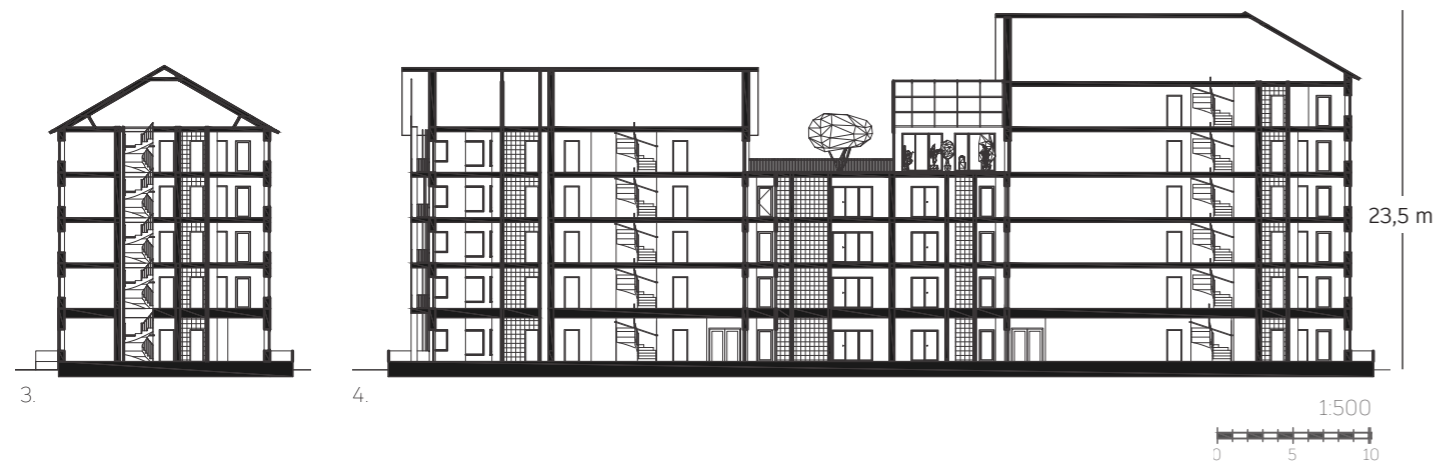
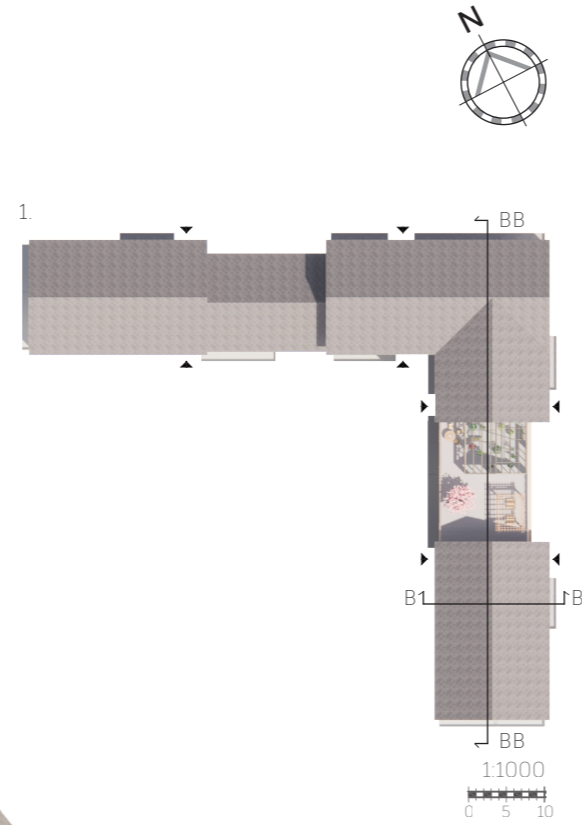



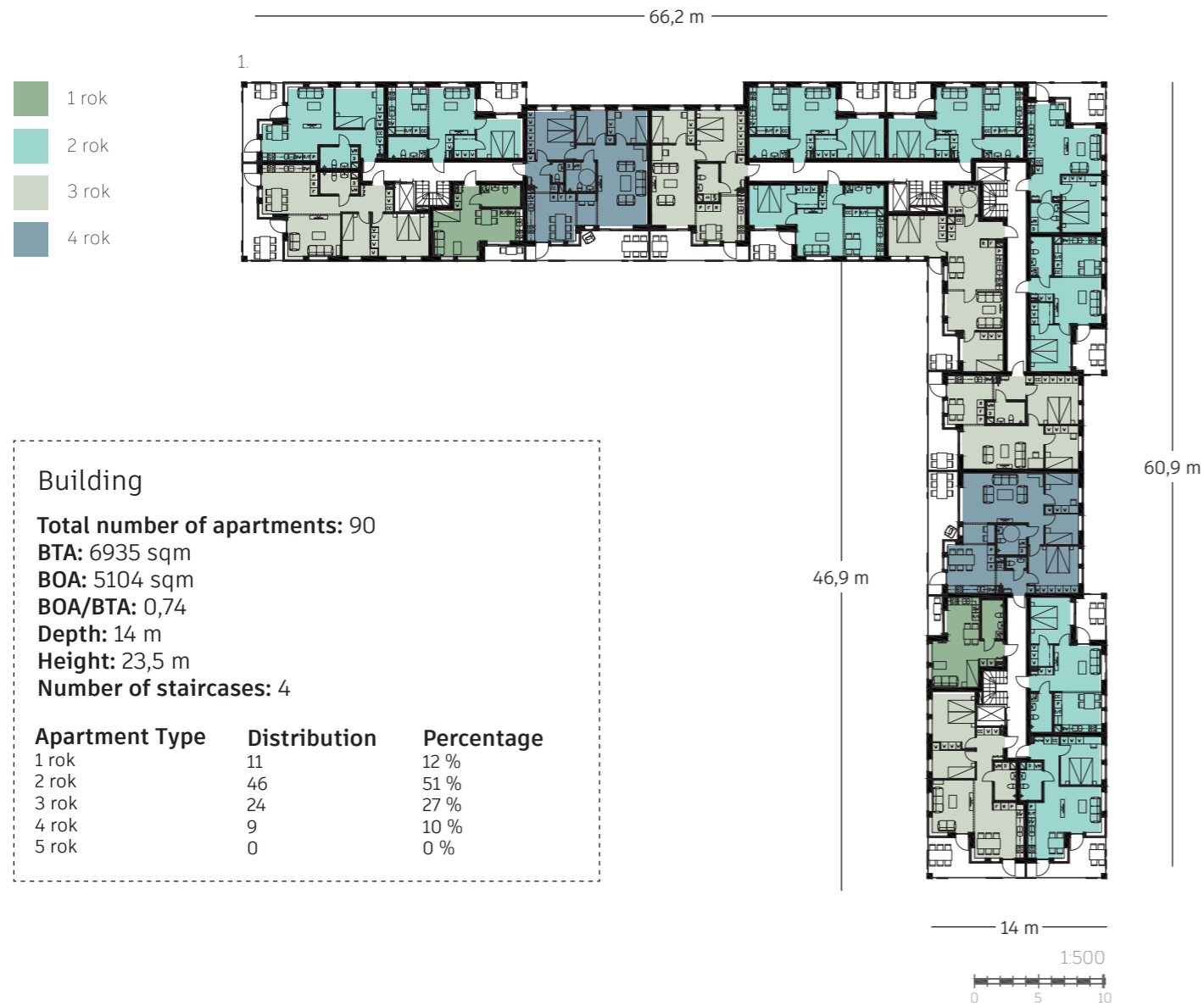

- 1 rok
- 2 rok
- 3 rok
- 4 rok

Building

Total number of apartments: 90
BTA: 6935 sqm
BOA: 5104 sqm
BOA/BTA: 0,74
Depth: 14 m
Height: 23,5 m
Number of staircases: 4

Apartment Type	Distribution	Percentage
1 rok	11	12 %
2 rok	46	51 %
3 rok	24	27 %
4 rok	9	10 %
5 rok	0	0 %

Standard floor plan

Number of apartments on standard floor plan: 18
Sqm of standard floor plan: 1352 sqm
Sqm of balconies on standard floor plan: 204 sqm

Apartment Type	Distribution
1 rok	2
2 rok	9
3 rok	5
4 rok	2
5 rok	0

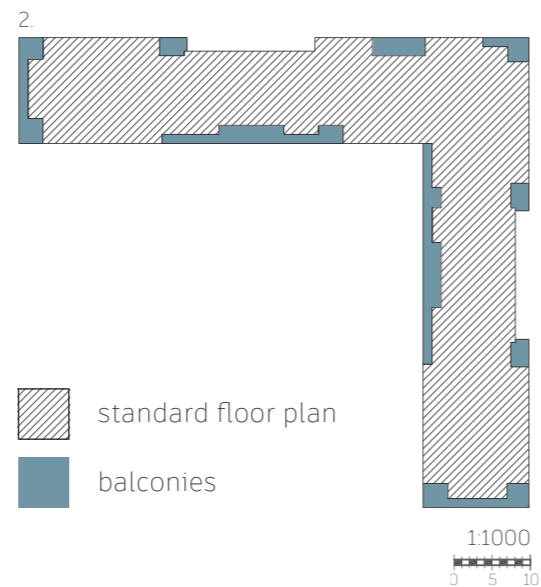

- standard floor plan
- balconies

Design strategy implementation

The following seven paragraphs describe how design attributes have been utilized and implemented in the design proposal.



Area efficiency

Area efficiency has been prioritized for the apartments, with the majority of units meeting the requirements for area efficiency set by MAB.



Axiality

Axiality has been utilized frequently in the apartment design to provide a sense of spaciousness. Movement axes have influenced the placement of doors and various room functions within the apartments.



Movement

Movement has influenced the layout of the apartments to allow for circular movement. The one-sided and corner apartments feature circulation through the balcony, while the two-sided apartments have circulation both through the balcony and around a centrally placed bathroom.



Room organization

The concept of room organization has influenced the placement of the bedrooms in a block, thus creating a private zone in the apartment. This arrangement has allowed for the living room and kitchen to become more of a public zone.

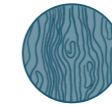

Material & details

The selection of materials and colors has been carefully chosen to create a cohesive and aesthetically pleasing design. The use of wood and neutral colors creates a warm and aesthetic atmosphere. Wooden bars have been added to the facade in some areas to create a more tactile feel and texture.

The design has also considered sound, with sound-absorbing materials being utilized in common areas and soundproofing measures integrated into the bedrooms. The interior walls of the apartments are coated with white plasterboard. Wooden materials are incorporated recurrently in the residence, with wooden wardrobes, doors, door frames, window frames and window sills and in details of the kitchen, such as the kitchen cabinets.

Light has been prioritized in the apartment design to create a bright and airy living space. Windows have been placed strategically to maximize natural light, with kitchen and bedroom windows having a sill height of 70 cm, and living room windows having a sill height of 40 cm.



Balcony

The balconies are pulled back from the facade to integrate seamlessly with the apartment and provide protection from the weather and exposure. They also contribute to the overall layout of the apartment and add an extra quality space. The majority of balconies feature two doors for a circular flow and direct access to the outdoor area from both the living room and kitchen.



Corner window

The corner window is a design feature that enhances the view and provides a feeling of freedom. Corner windows in the living room have a low sill height and a broad windowsill that can accommodate larger plants. This quality is implemented in corner apartments and double-sided apartments.

Example of implementation

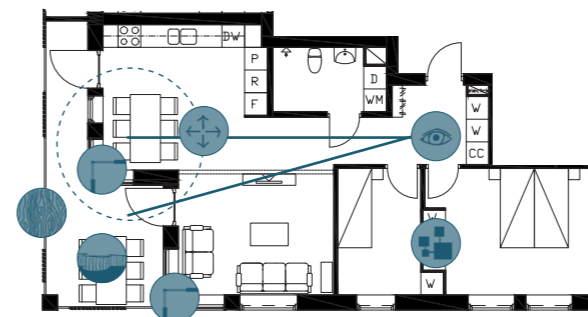

Entrance floor

The apartments on the entrance floor are elevated half a meter above the ground to create a buffer zone between the residences and the adjacent street. Additionally, these apartments feature a larger terrace that connects to the living space. The building has four entrances that pass through the building, resulting in a total of eight entry doors - four from the street and four from the yard. The interior of the communication areas, such as the corridor and staircases, feature wooden panels.



2.



1. Entrance floor | 1:250
2. Site plan | 1:750

3.



4.



3. Perspective from balcony
4. Axonometry of roof terrace

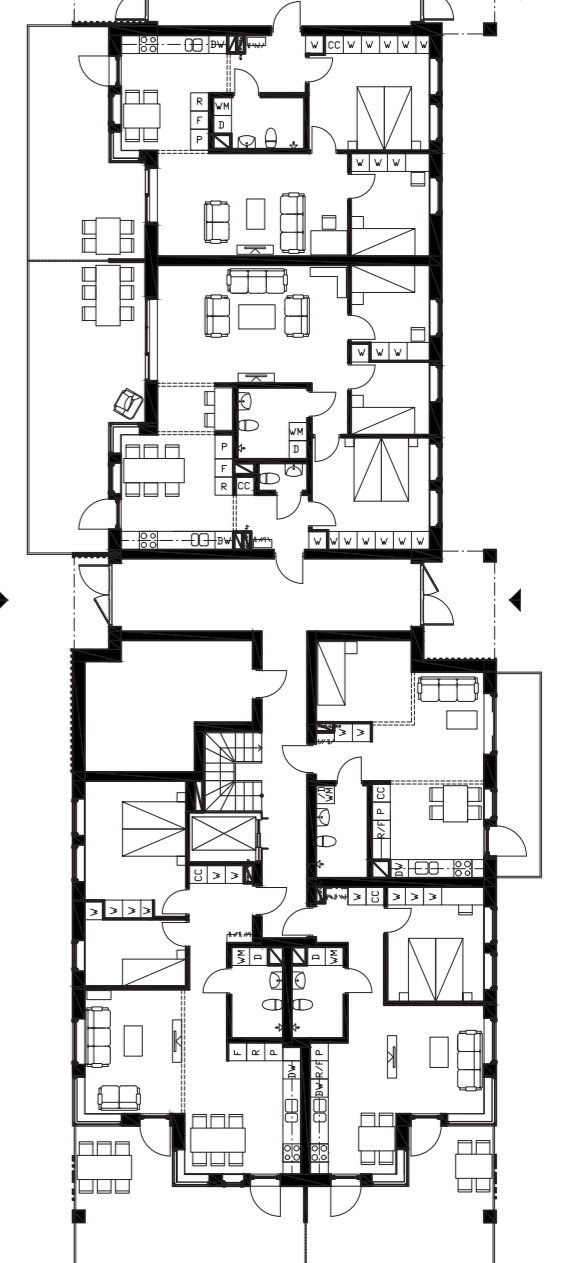

Standard floor

The standard floor plan consists of 18 apartments of different sizes, each incorporating several design attributes that enhance the architectural quality.

The design proposal includes various features such as sightlines that end in a view of the outdoors, movement axes, circular movement, the option to choose between private or public zones when entering the apartment, simple room shapes, and built-in storage. All apartments are designed with details such as door placement, indoor materiality, frames, and windowsills.

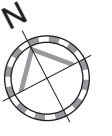
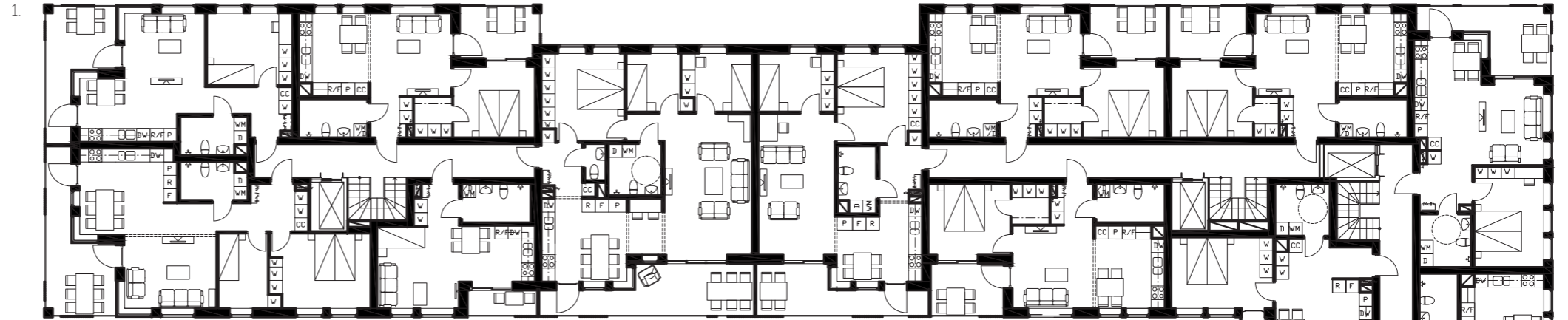

Apartments

The designed apartments will be evaluated according to MAB (Granath & Nylander, 2023) and are as follows.

Apartment I
Number of rooms: 2
Area: 48,8 sqm
Type: one-sided

Apartment II
Number of rooms: 2
Area: 49,5 sqm
Type: corner

Apartment III
Number of rooms: 3
Area: 68,9 sqm
Type: corner

Apartment IV
Number of rooms: 3
Area: 69,8 sqm
Type: double-sided

Apartment V
Number of rooms: 4
Area: 88,4 sqm
Type: double-sided

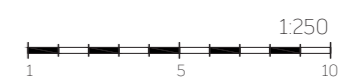
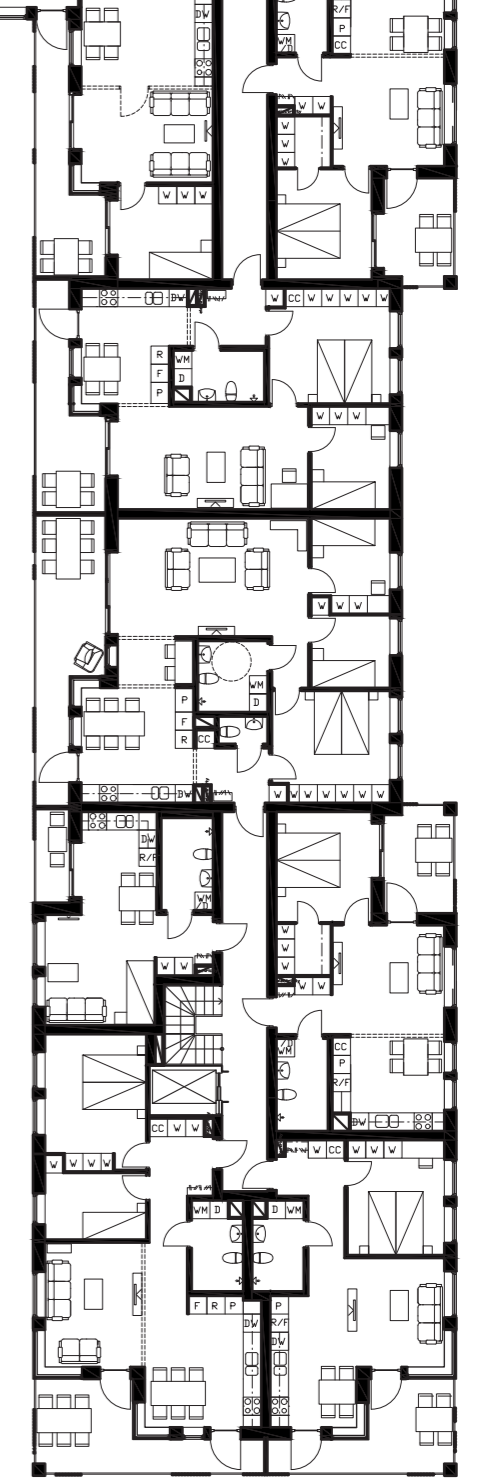

1. Standard floor | 1:250
 2. Exterior perspective courtyard
 3. Exterior perspective

- 1. Apartment floor plan | 1:100
- 2. Exterior perspective of balcony

Apartment I

2 r.o.k | 48,8 sqm

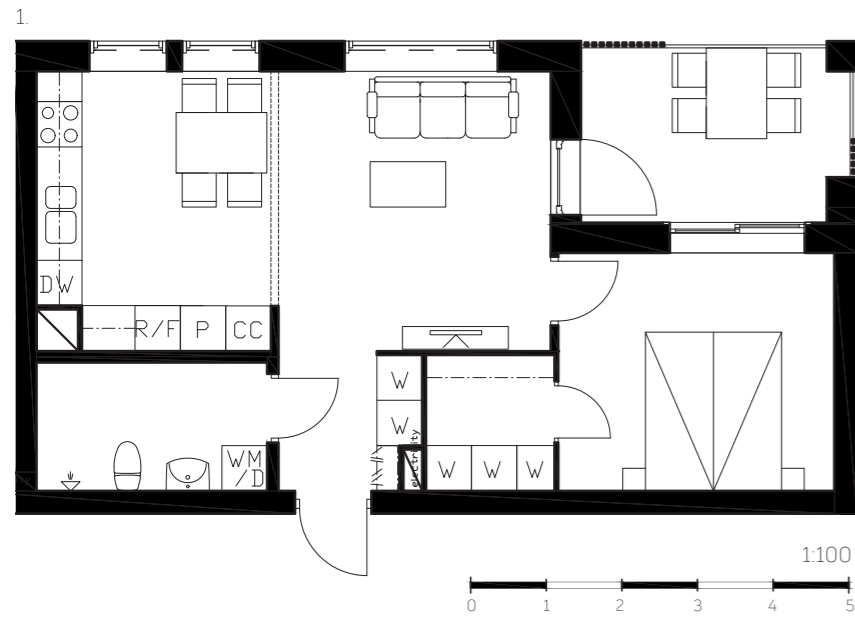

2.

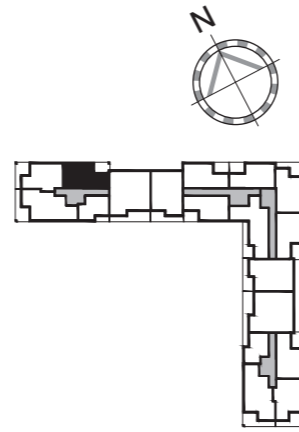

48,8 sqm (limit 49,7)

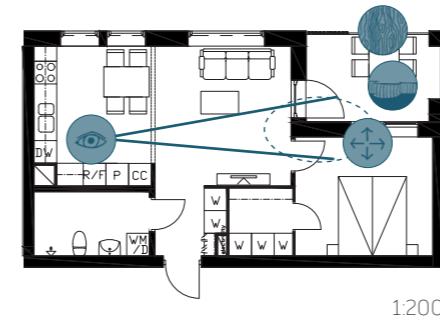

Grade according to MAB

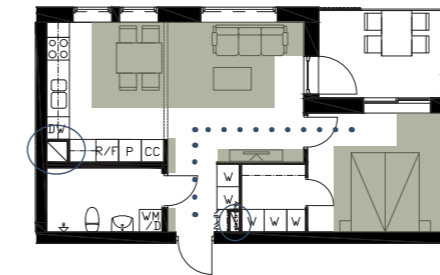

Functionality

- area efficiency
- technical rationality
- furnishable area
- potential to stay

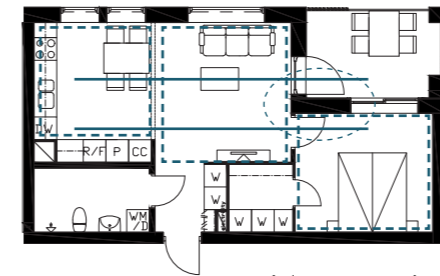

Spaciousness

- axiality
- movement
- shape of room
- flexibility

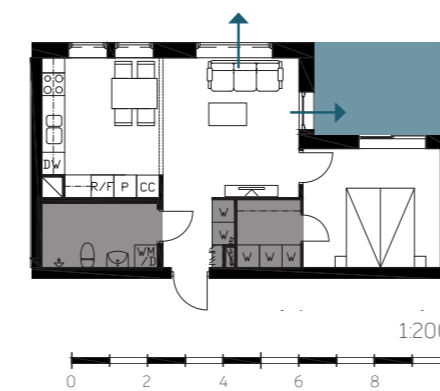

Atmosphere

- facade directions
- balcony
- designed daylight
- dark area

TOTAL GRADE	ASPECT	ASPECT GRADE	TOTAL	QUALITY	1/0
silver	FUNCTIONALITY	silver	2	area efficiency	1
				technical rationality	1
				furnishable area	0
silver	SPACIOUSNESS	gold	3	potential to stay	0
				axiality	1
				movement	1
silver	ATMOSPHERE	silver	2	shape of room	1
				flexibility	0
				facade directions	1
silver	ATMOSPHERE	silver	2	balcony	1
				designed daylight	0
				dark area	0

- 1. Apartment floor plan | 1:100
- 2. Interior perspective apartment

Apartment II

2 r.o.k | 49,5 sqm

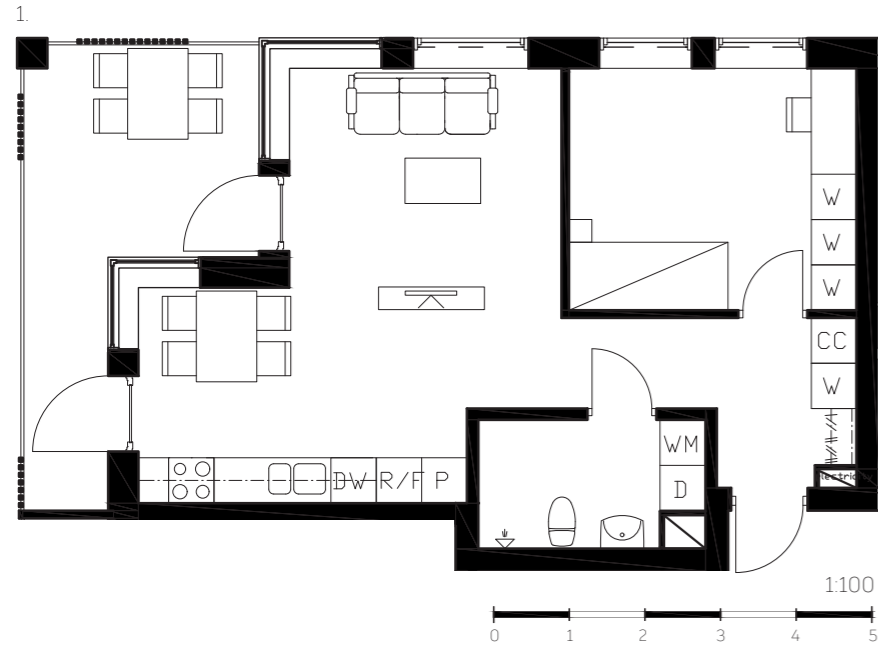

2.

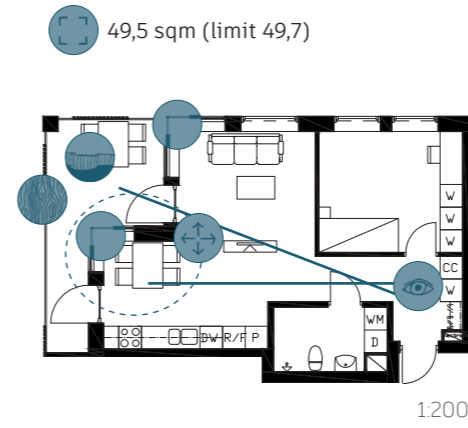
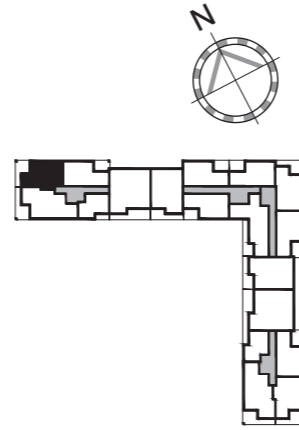

Two corner windows in the apartment provide a panoramic view and enhance the feeling of spaciousness. The bedroom's close proximity to the bathroom allows for easy access, while the living room and kitchen remain connected as a public space in the apartment.

Grade according to MAB

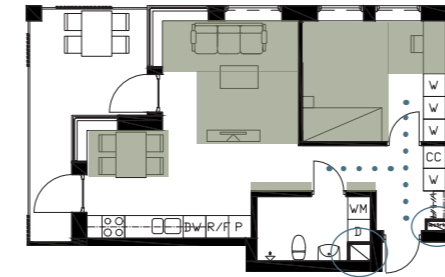

Functionality

- area efficiency
- technical rationality
- furnishable area
- potential to stay

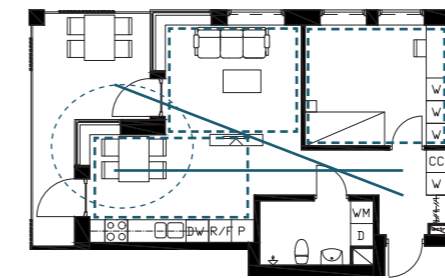

Spaciousness

- axiality
- movement
- shape of room
- flexibility

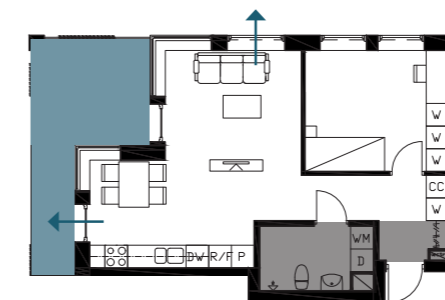

Atmosphere

- facade directions
- balcony
- designed daylight
- dark area

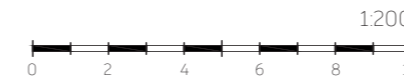

TOTAL GRADE	ASPECT	ASPECT GRADE	TOTAL	QUALITY	1/0
gold	FUNCTIONALITY	gold	4	area efficiency	1
				technical rationality	1
				furnishable area	1
				potential to stay	1
gold	SPACIOUSNESS	gold	3	axiality	1
				movement	1
				shape of room	1
				flexibility	0
gold	ATMOSPHERE	gold	4	facade directions	1
				balcony	1
				designed daylight	1
				dark area	1

- 1. Apartment floor plan | 1:100
- 2. Exterior perspective of a balcony

Apartment III

3 r.o.k | 68,9 sqm

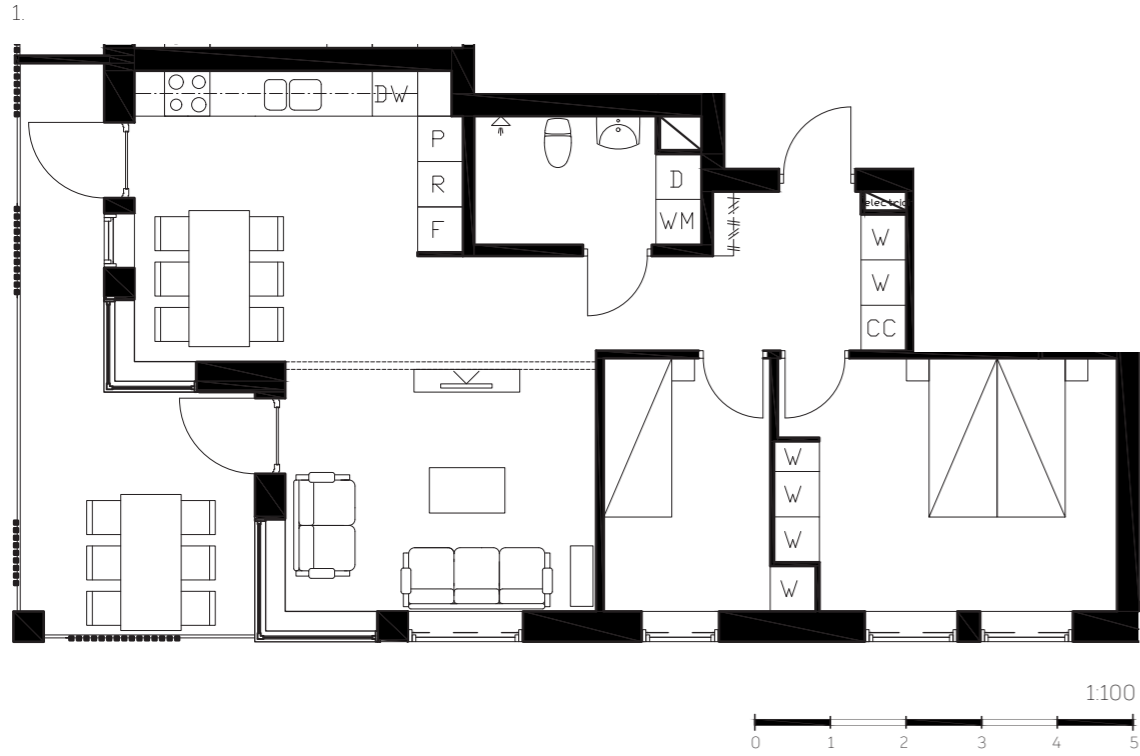

2.

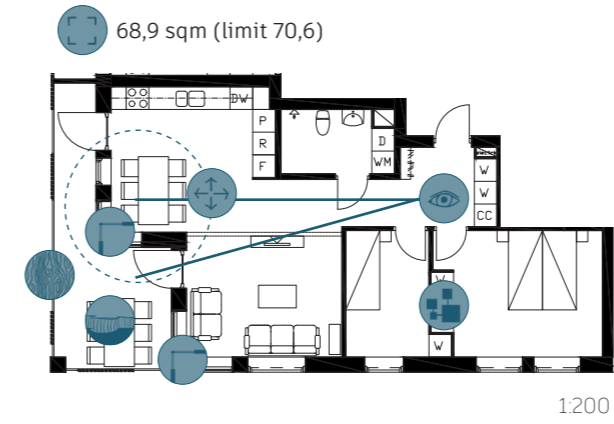
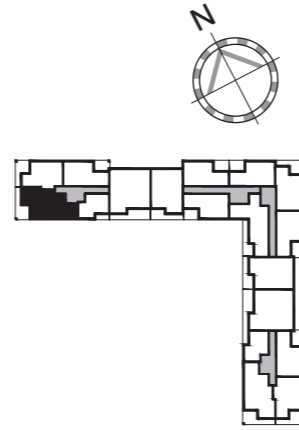

Like the previous corner apartment, this one also features two corner windows. The two bedrooms are organized together, connected to the hallway, creating a sense of enclosed and private space, while the living room and kitchen contrast with openness.

In contrast to the corner example in the case study, the long corridor has been shortened, and it is easy to separate the kitchen from the living room without compromising on the functionality or spaciousness of the rooms.

Grade according to MAB

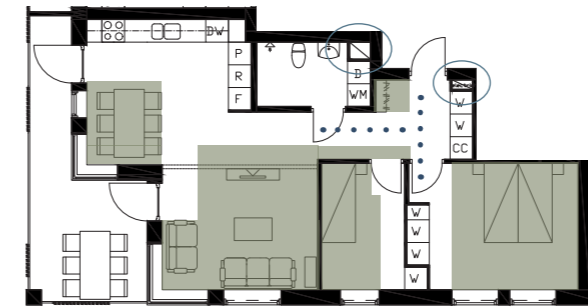

- Functionality**
- area efficiency
 - technical rationality
 - furnishable area
 - potential to stay

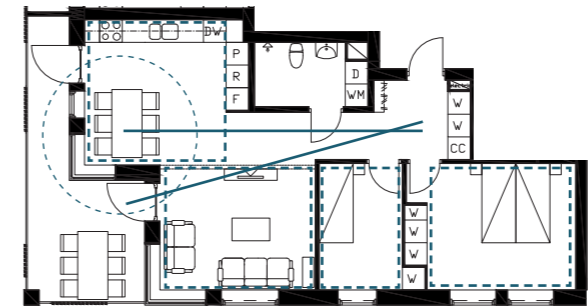

- Spaciousness**
- axuality
 - movement
 - shape of room
 - flexibility

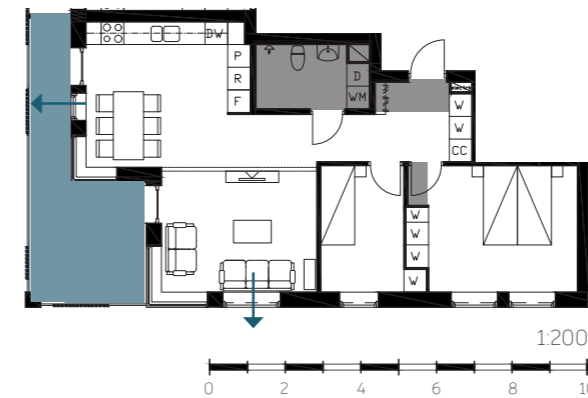

- Atmosphere**
- facade directions
 - balcony
 - designed daylight
 - dark area

TOTAL GRADE	ASPECT	ASPECT GRADE	TOTAL	QUALITY	1/0
gold	FUNCTIONALITY	gold	3	area efficiency	1
				technical rationality	1
				furnishable area	1
				potential to stay	0
gold	SPACIOUSNESS	gold	3	axuality	1
				movement	1
				shape of room	1
				flexibility	0
gold	ATMOSPHERE	gold	4	facade directions	1
				balcony	1
				designed daylight	1
				dark area	1

- 1. Apartment floor plan | 1:100
- 2. Exterior perspective from balcony

Apartment IV

3 r.o.k | 69,8 sqm

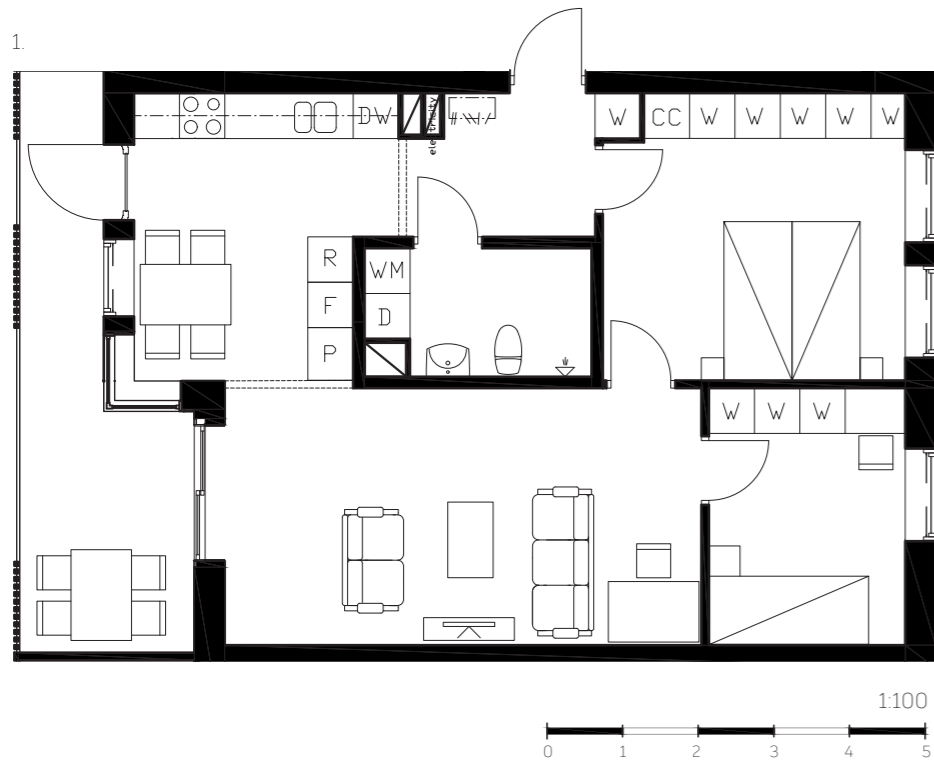

2.

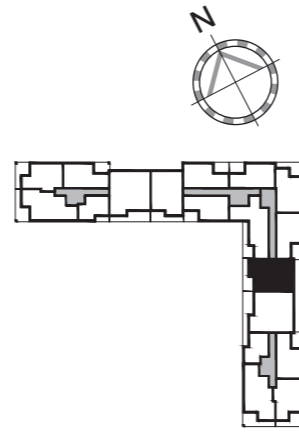

69,8 sqm (limit 70,6)

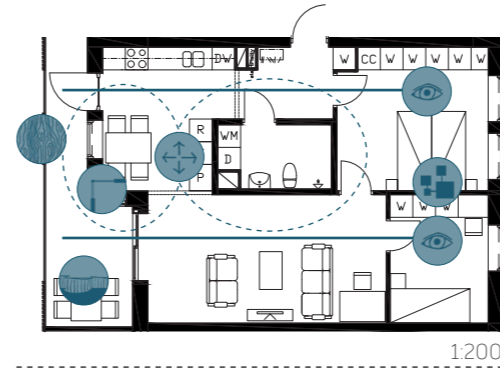

Grade according to MAB

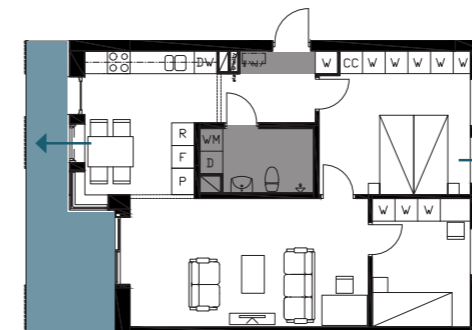
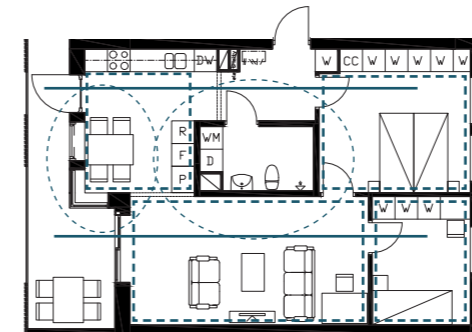
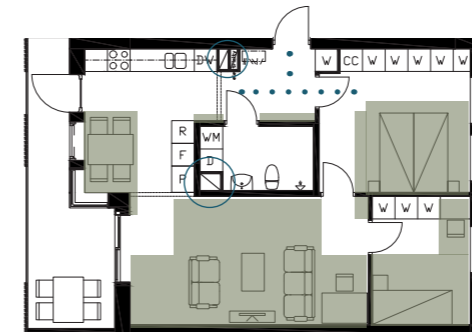

In contrast to the double-sided apartment in the case study, this design emphasizes circular movement, axially, and a closer connection between the master bedroom and bathroom. The living room and single bedroom are only reachable through the kitchen or master bedroom, this is not an optimal solution but a result of area efficiency since the space for an extra inner corridor does not exist.

The bedroom arrangement results in the social spaces being connected, while still allowing for easy separation with a wall if needed.

Functionality

- area efficiency
- technical rationality
- furnishable area
- potential to stay

Spaciousness

- axially
- movement
- shape of room
- flexibility

Atmosphere

- facade directions
- balcony
- designed daylight
- dark area

TOTAL GRADE	ASPECT	ASPECT GRADE	TOTAL	QUALITY	1/0
gold	FUNCTIONALITY	gold	4	area efficiency	1
				technical rationality	1
				furnishable area	1
				potential to stay	1
gold	SPACIOUSNESS	gold	3	axially	1
				movement	1
				shape of room	1
				flexibility	0
gold	ATMOSPHERE	gold	4	facade directions	1
				balcony	1
				designed daylight	1
				dark area	1

Apartment V

4 r.o.k | 88,4 sqm

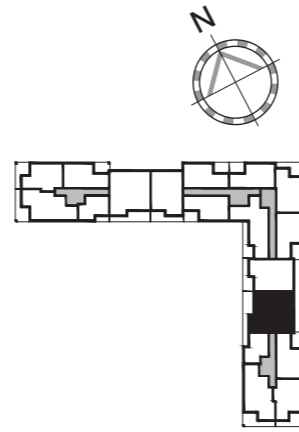

88,4 sqm (limit 89,0)

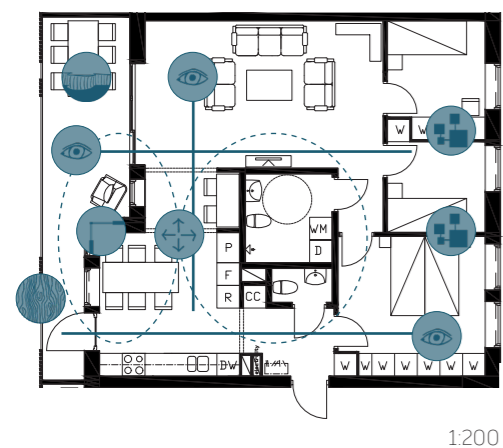

The apartment features a spacious balcony that connects kitchen and living room through the outdoors. A walk-through office or storage area is also incorporated between the two social spaces. The bedrooms are clustered together in a block with easy access to the bathroom, creating a more enclosed feeling for half of the apartment while the other half feels more open. The shorter depth of the building means that long distances are minimized compared to the distances in the respective apartment in the case study, also removing the dark middle part and improving the light conditions. Similar to the previous apartment, availability to the living room and the single bedrooms are compromised and the kitchen or master bedroom has to serve as a walk through room.

Grade according to MAB

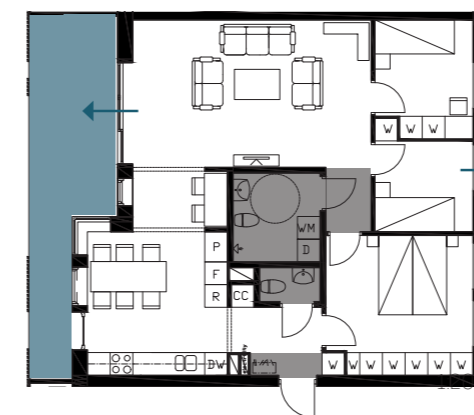
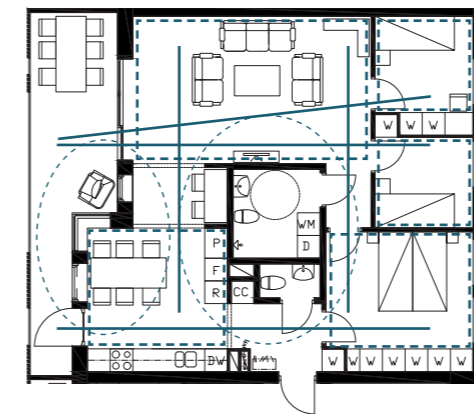
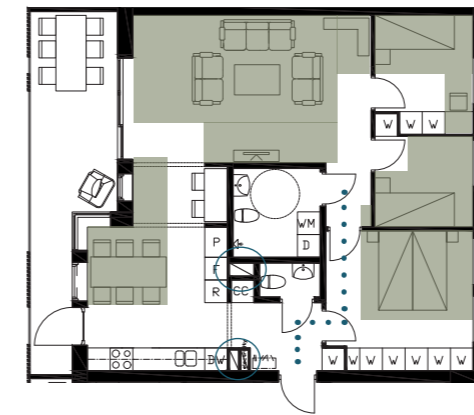

Functionality

- area efficiency
- technical rationality
- furnishable area
- potential to stay

Spaciousness

- axiality
- movement
- shape of room
- flexibility

Atmosphere

- facade directions
- balcony
- designed daylight
- dark area

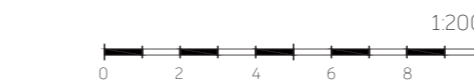

TOTAL GRADE	ASPECT	ASPECT GRADE	TOTAL	QUALITY	1/0
gold	FUNCTIONALITY	gold	4	area efficiency	1
				technical rationality	1
				furnishable area	1
				potential to stay	1
	SPACIOUSNESS	gold	3	axiality	1
				movement	1
				shape of room	1
				flexibility	0
	ATMOSPHERE	gold	4	facade directions	1
				balcony	1
				designed daylight	1
				dark area	1

08. DISCUSSION

Comparison

Existing proposal

Number of apartments on standard floor plan: 21
 Sqm of standard floor plan: 1614 sqm
 Sqm of balconies on standard floor plan: 164 sqm

Apartment Type	Distribution	Percentage
1 rok	9	8,5 %
2 rok	52	49 %
3 rok	35	33 %
4 rok	9	8,5 %
5 rok	1	1 %

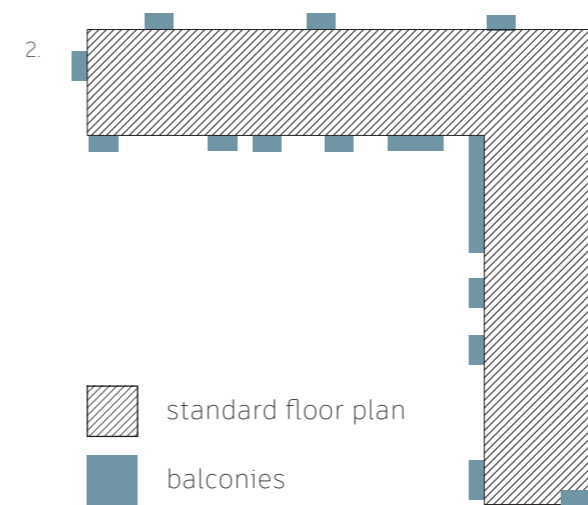

1. apartment distribution of existing proposal
2. standard floor plan analysis of existing proposal
3. apartment distribution of thesis design proposal
4. standard floor plan analysis of thesis design proposal

Thesis design proposal

Number of apartments on standard floor plan: 18
 Sqm of standard floor plan: 1352 sqm
 Sqm of balconies on standard floor plan: 204 sqm

Apartment Type	Distribution	Percentage
1 rok	11	12 %
2 rok	46	51 %
3 rok	24	27 %
4 rok	9	10 %
5 rok	0	0 %

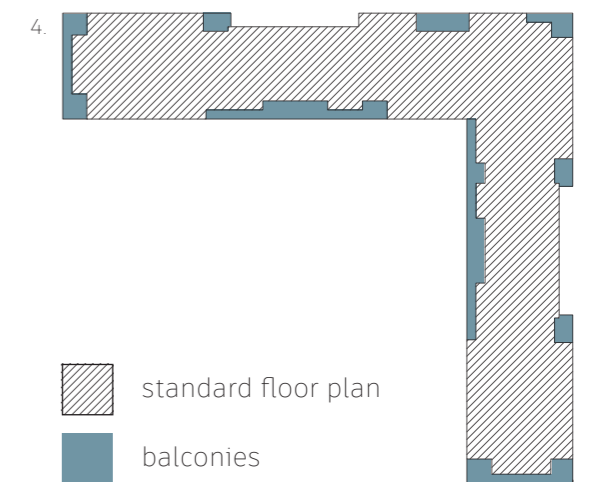
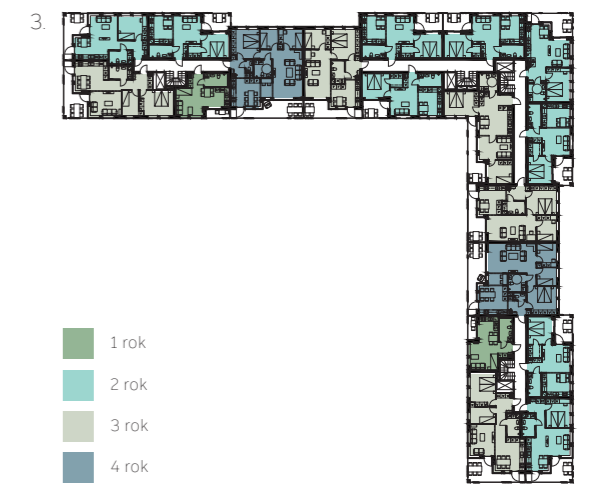

11000

bronz Apartment A
2 r.o.k | 45 sqm

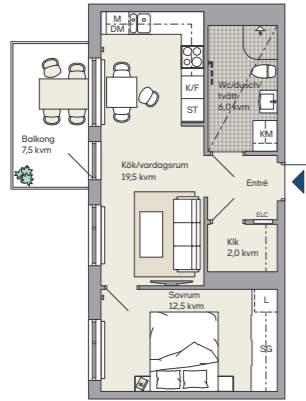

Figure 4.2

silver Apartment I
2 r.o.k | 48,8 sqm



bronz Apartment C
3 r.o.k | 77 sqm



Figure 4.4

gold Apartment IV
3 r.o.k | 69,8 sqm

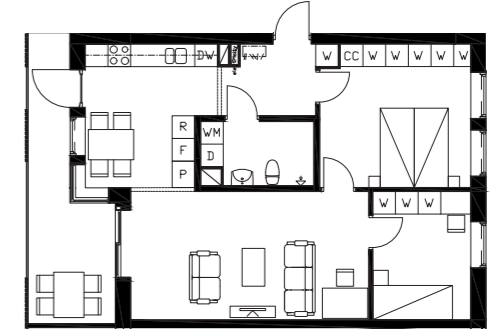

gold Apartment B
3 r.o.k | 73 sqm

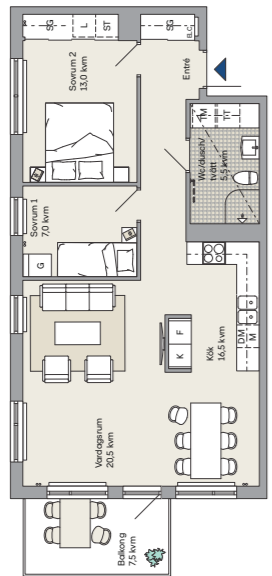
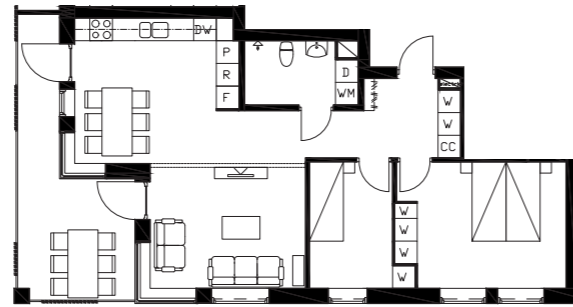

Figure 4.3

gold Apartment III
3 r.o.k | 68,9 sqm



silver Apartment D
4 r.o.k | 92 sqm



Figure 4.5

gold Apartment V
4 r.o.k | 88,4 sqm

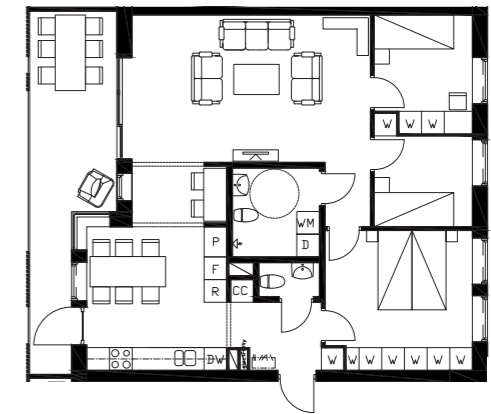

1. building volume of existing proposal
2. building volume of thesis design proposal

Existing proposal

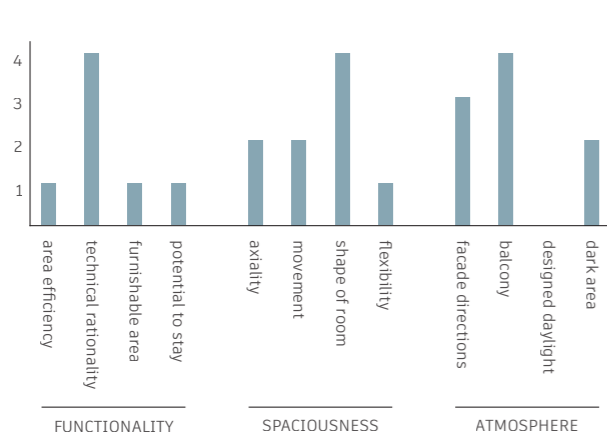

Several apartments in the case study are lacking the qualities outlined by MAB. Only one out of the four apartments achieved a gold rating. Moreover, the consideration of designed daylight was completely left out.

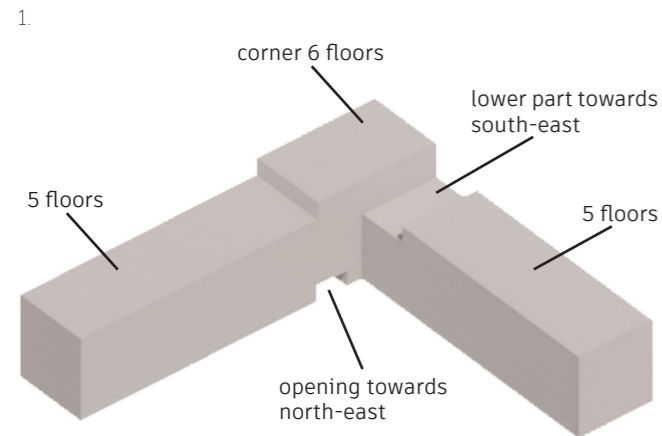

BTA: 8180 sqm
BOA: 6249 sqm
BOA/BTA: 0,76

Depth: 14 m
Height: 21,6 m
Number of staircases: 4
Total number of apartments: 106

Thesis design proposal

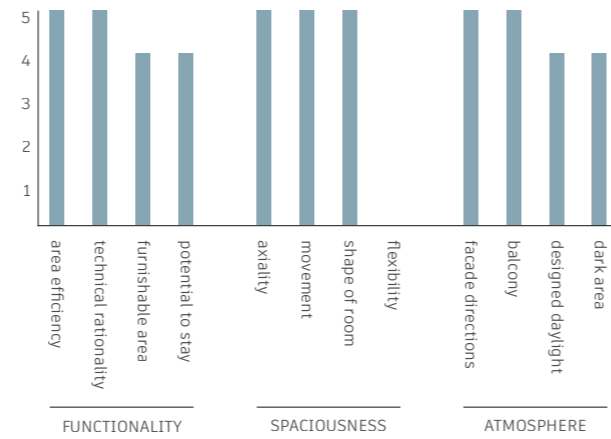

The majority of qualities assessed by MAB have been achieved. Four out of the five designed apartments have earned a gold rating. The only quality that falls short is *Flexibility*, primarily due to the efficient use of space in the apartments. Flexibility needs a certain amount of space, which is not available in these area-efficient apartments.

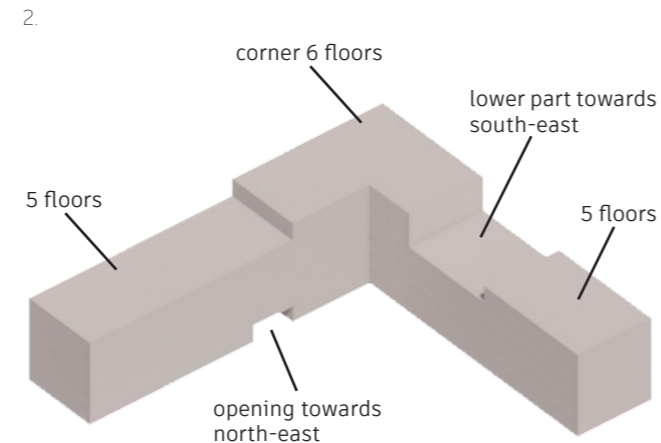

BTA: 6935 sqm
BOA: 5104 sqm
BOA/BTA: 0,74

Depth: 14 m
Height: 23,5 m
Number of staircases: 4
Total number of apartments: 90

Summary

The modifications made to the building resulted in:

- + construction of clt wood
- + facade in wooden panels
- + a larger entrance on the northeast side
- + a rooftop terrace with a small common building
- + a bigger sixth floor
- + retracted, sheltered balconies
- + 40 sqm added balcony area
- + 4/5 apartments with the grade of gold

- 262 sqm less buildable area per standard floor plan
- 3 apartments less per standard floor plan
- 16 apartments less in the whole building

Conclusion

Different types of apartment and the volume of the building affects the apartments quality. Certain types of apartments, such as the one-sided units, may be more difficult to design. The measurements of the building in the existing design proposal made the double-sided apartment 14 meters deep, which creates a dark middle part and gives smaller apartments of this type very little facade area, which impact the opportunity for windows and natural light. The one-sided apartments however, are becoming very narrow, impacting the room organization and compromise their furnishability.

The design proposal resulted in 3 apartments less per floor than the existing proposal, which obviously led to a significant loss of both units and profit. However, it is worth noting that the building area is significantly smaller. BOA/BTA in the design proposal is only 2% less than in the existing proposal. The main reason for this loss is the retracted balconies. With alternative balcony solutions, these three units could likely be accommodated, even though all apartments have been redesigned and planned differently, utilizing several design attributes and achieving a significantly higher architectural quality.

Thesis research questions

How design attributes improve the quality in different types of apartments are demonstrated in the floor plan drawings of the apartments. What impact the design attributes have on the overall building is answered in the comparison between the two design proposals in this chapter of discussion, featuring diagrams, floor plans, volumes and numbers of the two projects.

Reflections

In housing design, there is often a conflict between creating housing that meets the needs and preferences of residents and maximizing profits for developers. However, well-planned, area-efficient apartments can still include multiple design attributes that make them high-quality living spaces, as demonstrated by the design proposal that achieved the majority of grade gold according to the MAB analysis method.

As urban living spaces become more compact, design attributes become increasingly important for creating a sense of spaciousness and quality in smaller apartments. However, in area-efficient apartments, every inch counts, which means that quality features such as an extra bathroom in a 3 r.o.k., space for an extra shower in a 4 r.o.k., or sufficient space for storage are often sacrificed to make way for more living space. This is seen in the design proposal where in some apartments there's a lack of storage and the communication area goes through the kitchen or master bedroom. A quality that often is compromised is material and details, due to them being cut economically. As seen in the reference projects, extensive use of wood both interior and exterior are seen as a luxury instead of being available for everyone.

Added to the discussion of the current housing design and construction, one may question what is more important: providing good quality residences that are appreciated by residents, or achieving economic gain for the construction company. We live in a time where the focus should be on creating high-quality planning solutions that can withstand trends and offer multiple design attributes. It can be questioned whether it's really area efficiency that limits the use of design attributes or if it's purely an economic consideration. In today's architecture, there are many examples of apartments that do not include desired design attributes, they also do not meet the requirements for area efficiency according to MAB, which suggests that these apartments should have the potential to incorporate more quality if they were better planned.

Further improvement to the project

If the project should become even better, a significant change would be to investigate the site. Looking into the surroundings and locating factors such as the main street, where the school is placed and the weather directions, implementing how the sun is moving. An improvement would be to change the build volume and placement on the site to achieve better directions and opportunity for natural light.

09. REFERENCES

Literature references

Arkitekten. (2020, June 15). *Upphandlingsmyndigheten får nytt uppdrag om arkitektonisk kvalitet*. <https://arkitekten.se/nyheter/upp-handlingsmyndigheten-far-nytt-uppdrag-om-arkitektonisk-kvalitet/>

Axeloth Arkitekter. (n.d.). *Botanikern*. Retrieved 2023, May 3, from <https://axeloth.se/botanikern/>

Boverket (2020, October 21) *Bostadsutformning – lämplig för sitt ändamål*. <https://www.boverket.se/sv/byggande/tillganglighet--bostadsutformning/bostadsutformning/>

Boverket (2022, March 4) *Bostadsutformning*. <https://www.boverket.se/sv/PBL-kunskapsbanken/regler-om-byggande/boverkets-byggregler/bostadsutformning/>

Caldenby, C. & Hallemar, D. (Ed.). (2020). *Tiotalets svenska bostad*. Stockholm: Arkitektur förlag.

Caldenby, C., Nylander, O., & Kub Arkitekter. (2019). *Rita bostäder: Elva bostadsprojekt från KUB arkitekter. Reflektioner kring en bostadsritarkultur*. Stockholm Arkitektur Media.

Genova. (n.d.). *Botanikern vinner Uppsala Arkitekturpris 2020*. Retrieved 2023, May 3 from <https://genova.se/upsala-arkitekturpris-2020/>

Granath, K. & Nylander, O. (2023). *MAB Manual för analys av bostadskvaliteter*. [Unpublished manuscript.]. CBA, Chalmers University of Technology.

HSB. (n.d.). *Arkitektur genom tiderna*. Retrieved 2023, February 20, from <https://www.hsb.se/stockholm/om-boende/bokunskap/arkitektur/>

HSB. (2015, May 29) *Årets bästa HSB-projekt ligger i Göteborg*. <https://www.hsb.se/nyheter-och-tips/nyheter/2015/arets-basta-hsb-projekt-ligger-i-goteborg/>

Nylander, O. (2021) *Criteria List of Housing Architecture Properties—A Way to Promote Residential Quality?* in Gromark, S. & Andersson, B. (Ed.). *Architecture for residential care and ageing communities: spaces for dwelling and healthcare*. (pp.39-52) New York, NY: Routledge. <https://doi.org/10.4324/9780429342370>

Nylander, O. & Forshed, K. (2011). *Bostadens omätbara värden*. HSB Riksförbund.

Nylander, O., Femenías, P., Andersson, M., Morichetto, H., & Braide, A. (2018). *Bostadsforskare om bostadskvalitet*. Chalmers tekniska högskola AB. https://research.chalmers.se/publication/503607/file/503607_Fulltext.pdf

Nylander, O., Granath, K., Femenías, P., & Gren, J. (2019). *Bygglov Göteborg 2016*. [Göteborg]: Chalmers university press.

Pollio, V. (2016). *The Ten Books on Architecture: De Architectura*. Createspace Independent Publishing Platform.

Roberts-Hughes, R. (2011). *The case for space : the size of England's new homes* (W. Fox & A. Scott-Marshall, Eds.). Royal Institute of British Architects

Skanska. (n.d.). *Ett av Sveriges största byggföretag*. Retrieved 2023, March 10, from <https://www.skanska.se/om-skanska/skanska-i-sverige/kort-om-skanska/>

Skanska. (2022). *Informationsbroschyr Klassrummet [Broschyr]*. Retrieved from <https://bostad.skanska.se/sok-bostad/goteborg/molndal/klassrummet-vetenskapen/>

Stockholmskällan. (2022, April 6). *Miljonprogrammet*. <https://stockholmskallan.stockholm.se/teman/staden-vaxer/miljonprogrammet/>

Svenskt Trä. (n.d.). *Strandparken - Svenskt Trä*. Retrieved 2023, May 3, from <https://www.svenskttra.se/inspiration/trapriset/traprisbockerna/strandparken/>

Bibliography

Figure 2.1-2.2, 3.9 : Caldenby, C. & Hallemar, D. (Ed.). (2020). Tiotalets svenska bostad. [Floor plan, Chart,]. Stockholm: Arkitektur förlag.

Figure 3.1: Roberts-Hughes, R. (2011). The case for space : the size of England's new homes. [Chart]. (W. Fox & A. Scott-Marshall, Eds.). Royal Institute of British Architects

Figure 3.2, 3.12, 4.1: Granath, K. & Nylander, O. (2023). MAB Manual för analys av bostadskvaliteter. [Chart. Unpublished manuscript.]. CBA, Chalmers University of Technology.

Figure 3.3-3.8: Nylander, O., Granath, K., Femenías, P., & Gren, J. (2019). Bygglov Göteborg 2016. [Floor plan. Göteborg]. Chalmers university press.

Figure 3.10, 5.3-5.5: Caldenby, C., Nylander, O., & Kub Arkitekter. (2019). Rita bostäder: Elva bostadsprojekt från KUB arkitekter. Reflektioner kring en bostadsritarkultur. [Floor plan. Perspective]. Stockholm Arkitektur Media.

Figure 3.11: Widerlöv Fastighetsmäklari. (2023, April 21). Torgny Segerstedts allé 89 - Widerlöv Fastighetsmäklare.[Floor plan]. <https://widerlov.se/bostader/torgny-segerstedts-alle-89-2/>

Figure 4.2, 7.1: Skanska. (2022). Planlösningsbroschyr 1-2 rum och kök [Floor plan. Site plan. Broschyr]. Retrieved from <https://bostad.skanska.se/sok-bostad/goteborg/molndal/klassrummet-vetenskapen/#bostader>

Figure 4.3-4.5: Skanska. (2022). Planlösningsbroschyr 3-5 rum och kök [Floor plan. Broschyr]. Retrieved from <https://bostad.skanska.se/sok-bostad/goteborg/molndal/klassrummet-vetenskapen/#bostader>

Figure 5.1: Widerlöv Fastighetsmäklari. (2023, April 21). Torgny Segerstedts allé 89 - Widerlöv Fastighetsmäklare.[Floor plan]. <https://widerlov.se/bostader/torgny-segerstedts-alle-89-2/>

Figure 5.2: Axeloth Arkitekter. (n.d.). Botanikern. [Floor plan]. Retrieved 2023, May 3, from <https://axeloth.se/botanikern/>

Figure 5.6-5.7, 5.9: Divisare. (n.d.). Wingårdhs · Strandparken Building B. [Floor plan & Perspective]. Retrieved 2023, April 12, from <https://divisare.com/projects/264352-wingardhs-strandparken-building-b>

Figure 5.8, 5.10: Residence. (2016, January 12) Arkitekturdröm i Sundbyberg - helt byggt i trä. [Perspective]. <https://www.residencemagazine.se/hemma-hos/arkitekturdrom-i-sundbyberg-helt-byggt-i-tra/3773825>

Figure 7.2: Illustrations of perspective, facades, floor plan & sections made by thesis author, original drawings and 3D-model made by Skanska.

All photos, illustrations and drawings that don't have a figure tag are owned or produced by the thesis author.



CHALMERS

RAISE YOUR STANDARDS
an investigation of how design attributes
improve the quality in apartments

A master thesis written by
Ellen Bensköld

Chalmers University of Technology
Department of Architecture and Civil Engineering
Architecture and Urban design (MPARC) 2023

