

cross

tracks



Some uses are planned and formal, some are informal, accidental, spontaneous or even illegal. Some occur when a city is shrinking, some when it is growing, Some uses last for a night or weekend, some are seasonal, while others may last five years or more.

(Bishop, Williams, 2012)



2023

Cross tracks

Erkka Juusela

Chalmers University of Technology

Examiner: Marco Adelfio
Supervisor: Ida Röstlund

Architecture and
urban space design

Table of contents

Abstract	4
Vocabulary	5
Background	6
Problem	6
Aim	6
Thesis question	7
Delimitations	8
Method	9
<i>theory</i>	10
Temporary architecture.	11
Scales and local connection	12
Resilience	13
Critical regionalism and event management	14
Framing the project	15
<i>case study</i>	19
Falun	20
Falun 2015	22
Municipal events	22
Current event placement	25
Current off season placement	25
Development	26
Proposed event placement	31
Proposed off season placement	33
<i>Local typologies</i>	34
<i>Structures</i>	39
Specific sites	40
Sauna	42
Stand	48
Pavilion	54
Maja	60
Stage	66
Discussion	72
List of illustrations	74
Student background	74
Bibliography	75

Abstract

When looking at the current management structures surrounding large scale temporary events we see that they are often in the hands of few organizers (Olympic committee, FIFA, FIS) yet the actual impact is often felt by the local community and biodiversity. After the impact continues when often these areas fall derelict or at least are underused. This can be seen when looking at Beijing Olympic 2022, FIFA World Cup 2022 and possibly Fis Planica 2023. There is an evident need for restructuring the management and building process of these events.

This project discusses event architecture and how structures can be built to support the event as well as the local community further on. The purpose is to examine the current building process and to illustrate an alternative to a permanent building process by using temporary and mobile structures that reflect their program and local identities in their visual form.

The project started from a personal fondness towards cross country skiing and uses one of these events as a case study to illustrate the larger topic of creating event spaces with its problems and opportunities at a manageable scale. Some facets of the project aim to be more universal such as the discussion between added flexibility and local identity as well as implementing plasticity to the surrounding permanent building stock whereas some are specific to the local case study namely the chosen structures, material use, location and appearance of the structures. These facets were studied and discussed at different points during the project.

In the thesis the normative and usually top down process of building permanent event structures for temporal use is mapped. The concept of temporality is later investigated through the case study of the cross country ski world cup event in Falun. This is done by exploring how small scale structures that are permanent in material use, temporary in placement and arrangement and mobile in their nature. The case study brings together short term and long term needs for both the event and commu-

nity in five structures that all influence different topics (social, cultural, commercial, public and private) in the area and have different appearances based on their programmatic needs and physical context whilst still remaining flexible enough to support changes in use or placement.

Keywords : Temporary/Mobile Architecture,
local community, event architecture, Falun



Vocabulary

Program :

Determined set of expected occurrences, a list of required utilities for the program to be performed in allocated space.

Temporary :

The intention of the use is temporary, it may prove to be a longer period of time or not happen at all but the intention of the use is temporary

Event :

A formalised and predetermined activity

Void :

Area of events and space to be reclaimed by community

Permanent :

In this project permanent means a structure built to be standing for a long time, permanent should only consider the material usage rather than the form or the function

Background

This project started from a personal fondness towards cross country skiing and the places it takes place in.

Looking at these places we see a phenomenon of building space for human activity in rural settings for temporary purposes using permanent building methods. The project also touches on future development of more rural towns when climate change forces us to move to more northern (or southern) and possibly higher locations in seek of places for the sport, meaning a new insurgence in the built structures in these areas and diminishing use in existing places.

Cross country skiing events are temporary in their nature yet in most cases semi permanent due to the yearly use. The existing infrastructural needs for the event (energy, transport ect.), seasonal changes in weather, ecological effects from using often forests to host events, climate change that makes some locations unfeasible. This combined with the local context and culture creates a rich set of limitations that has to be navigated to create a functional yet beautifully experienced spaces that can be used for a wide range of uses yet does involve the local community in the process and minimizes the physical footprint.



6 Image 1. Falun critical snow conditions in 1989

Problem

If we look at previous attempts of building space for temporary human use in rural settings like the winter Olympics they often are done through permanent building processes even when the use is temporary, which leaves building structures such as a ski jump tower or a olympic village in a place where no real long term need exists. Often these places fall derelict or are underused and creates long lasting environmental and social impact on local areas. The same goes for festivals, biennials, concerts and other sports events.

The design of these events is also done from a distance, meaning there are national objectives, global ideologies and commercial goals which often sideline the local needs, cultural aspects and the natural development of the area.

To illustrate the problem we can look at historic examples such as Sochi (Russia) , Berlin (Germany) or Rio De Janeiro (Brazil) Olympic games but we can also look at recent events such as Fis Planica (Slovenia) 2023 games.

Planica was an event organised by Fis (The International Ski and Snowboard Federation) in Slovenia for the Cross country ski World Championship where the building process included structures such as a new VIP pavilion, three story underground car park and upgrades to existing structures.

Although no official numbers are yet released the event was highly criticized in the media for lack of snow, long transport times to the venue and lack of audience.

However there are existing locations such as Oberstdorf in Germany that hosts Fis world Cup events but in recent years has suffered from climate change that has led to a lack of snow which has put the future of the location in jeopardy (Yle 2023).

This combination of constant uncertainty in the event and the top down building process makes it hard for the local community to be resilient, take ownership and preserve their identity.

Aim

This thesis aims to look at the location (often a city or town) of the event from a longer term perspective than just the event. As illustrated in the problem section the local context is often used to support the event and the aim of this thesis is to look at how the event can support the context. Rather than creating space for the event, how can we create space for the community that can be used for the event when needed but functions for the community in the meantime. And how can we make these structures appearance specific to their context rather than adverts for global corporations. In this way the thesis also aims to discuss how architecture can impact the power imbalance between local actors and national or global organisations.

Thesis question

The process that the project follows and how the question is studied.

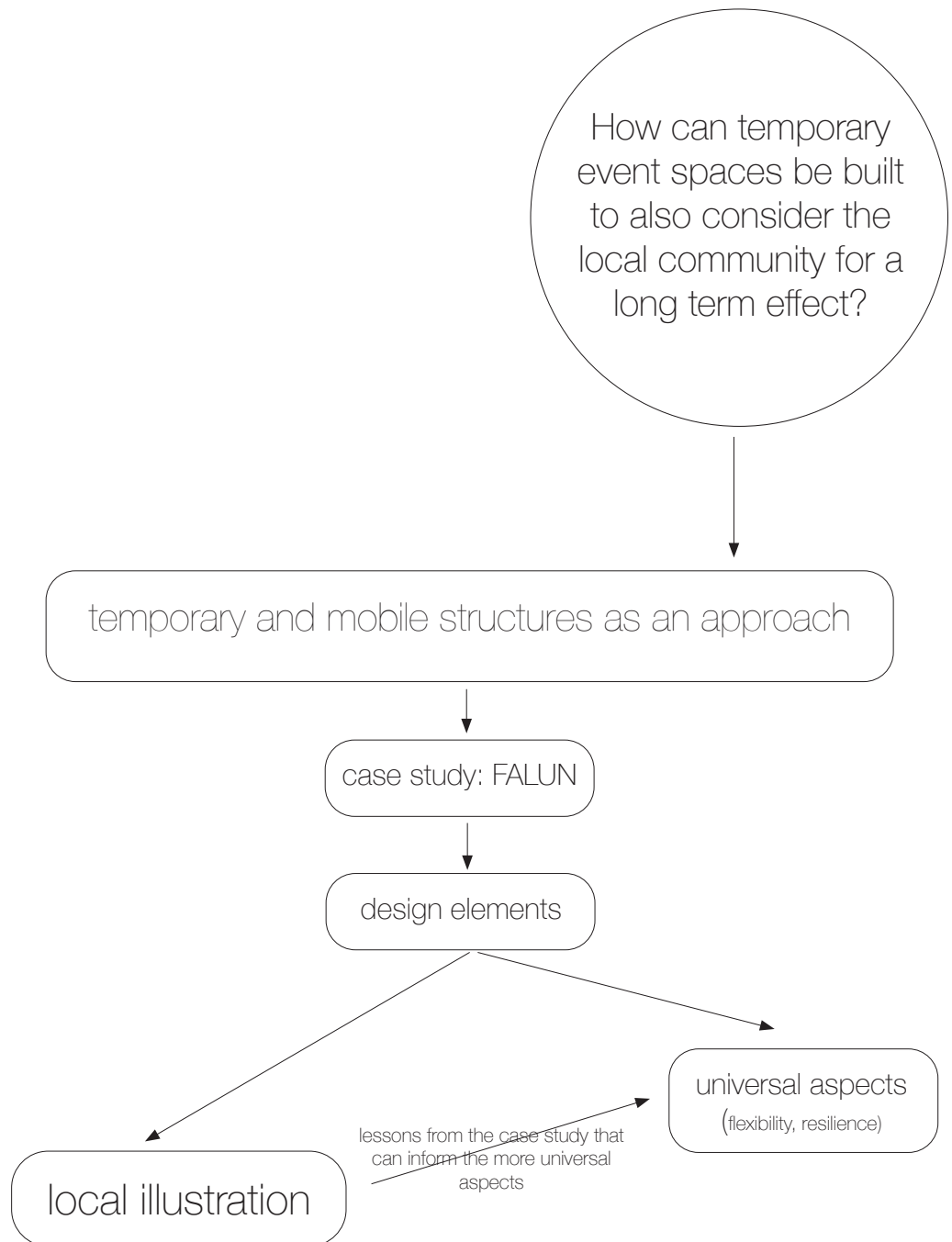

Delimitations

Whilst the thesis discusses the larger implications of temporary structures and event management the following limitations were set to create a meaningful study.

This thesis looks at a specific event and location to study and does not propose or discuss the scope of architecture as a field itself and its effective scales. Although the thesis touches upon the global challenges it has to be understood that every location has specific difficulties and futures and the thesis does not aim to create a universal solution or a pathway into event space creation rather it discusses explicitly through a case study how context specific the event space creation should be.

Neither does it advocate for all structures and buildings to be temporary but it discusses the value temporary structures have within and among permanent structures.

This thesis does not aim to be an example of critical regionalism since it does not consider the planning methods and development of the location, still the parallels between universalities and local cultures in critical regionalism and the event management and local community in event creation are too similar not to mention.

The thesis does not discuss the financial effect of the event or how the taken approach would influence it since the thesis interest lies in the physical space created for the events.

The chosen case study had to be in a context which would be feasible to visit and study from a far. In addition it had to host current events, have a strong local identity, need for new structures and possible difficulties in terms of hosting the formal event in the future.

Technical limitations

The structures should be able to move in their context and thus height, width and length limits were set for the structures

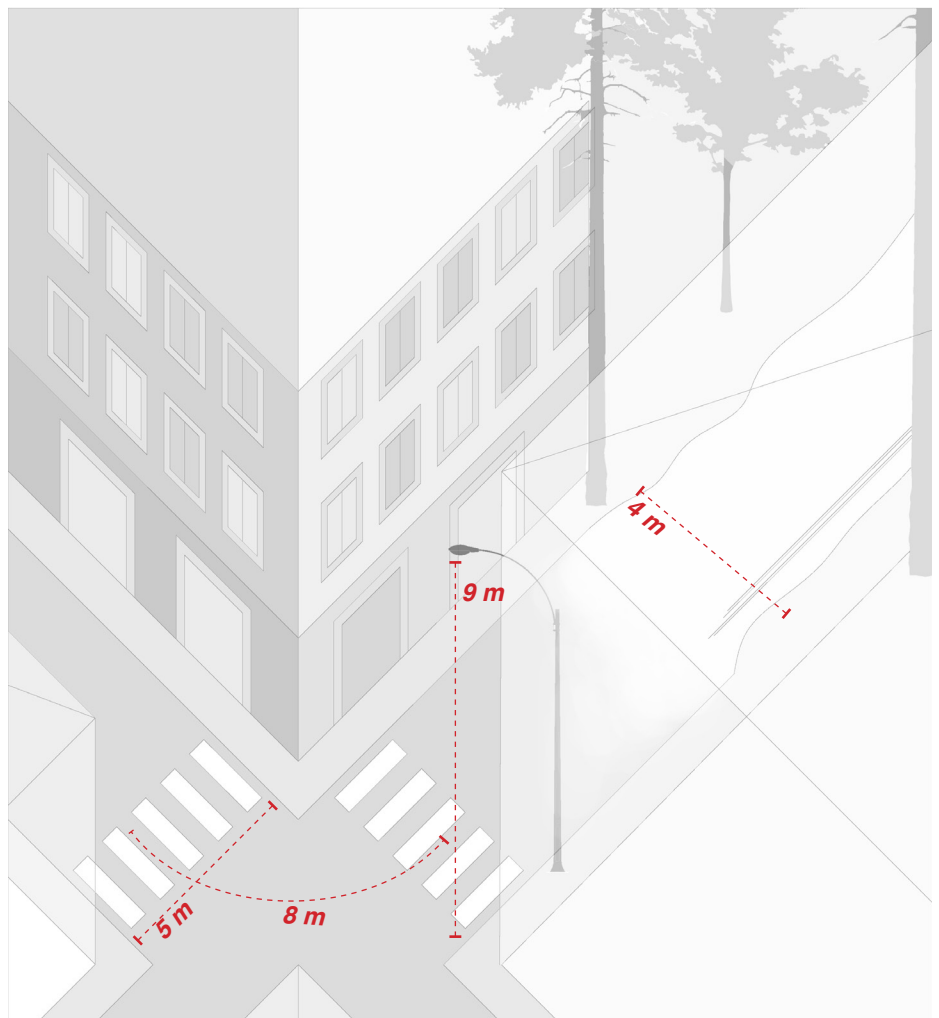

Method

This project is a research by design project where a case study design was created to discuss and illustrate the raised problems and possible solutions. This was done through photography, mapping, collages, technical drawings, reading, diagrams and model making

Understanding the context

Two site visits were undertaken to understand the context. Due to the time limitations of the thesis both visits fell during the winter season but more importantly two different times were visited. Firstly during a more relaxed and calm period which is the site's most common atmosphere and the second during a large scale event (the Fis Cross country ski World Cup) when the site has an influx of people. During these visits the site was documented through photography and audio recordings. During the latter visit I also became involved in the event as a volunteer to understand how the event functions and is organised.

The local context was also studied through reading articles, historical documents and planning documents to gain an overall understanding of the site.

By reading what the event organisers, the municipality and county sees as important, physical and social aspect were identified. This was used to identify what should be built, for whom and where. This was done through diagrams and tables .

Apperance and design of the strucutres

The appearance of the structures is derived from the local context. understanding Falun was done though reading informationa and looking into the history of Falun aswell as site visit material three different local typologies were created to be used as a design kit for the structures. After each structures context was established the typologies (collected feel and outlook of different areas in the town), almost always being two, would inform shapes, materials and colours for each one to create structures that pull from both contexts

but are not mimicking or recreating existing structures. This is an attempt to move away from the current design of the spaces that are often dull and universal, built mostly to just function.

The design of the case study structures is illustrated in multiple ways to illustrate the project from city wide- to detail level.

Maps were created to illustrative the movement of the structure, sections and plans for the use, models and renders for the expression and detail drawings to understand structure specific design.



theory

Temporary architecture.

The origins of temporary architecture in relation to events is hard to pin down but there are examples dating back to the ancient times when structures were erected for the kings coronation or passing (Chabrowe, 1974). From that time (in the Western European culture) temporary structures have played an important role even if they have not formally or conventionally been a important topic in architecture. Although the world fair or multiple architectural biennials have always had a temporary aspect to them the structures can be seen more as a vehicle for an agenda or as a commercial space but temporary, ad hoc and pop up structures play a more vital role as well. In urban contexts, on the fringes social activities often use empty or abandoned spaces. Good examples of these are found in Berlin where spaces are transformed into nightclubs, art studios and housing (Oswalt, 2013).

By contrast we have a simpler use of short term structures, mainly pop up architecture or environments. Gaetano Bertino in their book *Framework Conditions and Strategies for Pop-Up Environments in Urban Planning* (2019) defines pop up as a temporary activity that can refer to different appearances and pop up environment as a physical structure or a space that emerges quickly. A space that is designed to be impermanent and constructed to adapt the space and that is meant to fulfil the users functional and aesthetic requirements.

Although pop up architectures origins are in commercial use such as pop up shops to capitalize on trends (Bertino et al, 2019) this definition can be seen to expand this method of building towards larger implications and clearly has aspects that encroach on the examples previously given about temporary architecture to make a clear distinction between the two. Rather they complete each other. While temporary architecture deals with more social and societal issues, pop up architecture gives a more architectural aspect to the structures.

Recently both fields have become an interest to urban planners and city

officials. Architectural scholars have for a long time argued for the importance of temporary structures.

In the article *Temporary use of space: Urban processes between flexibility, opportunity and precocity* a multitude of architectural researchers talk about the role of temporary structures from different aspects. Martin Eberle argues that temporary use of use of space critiques the status quo (current city planning) and can acts as catalyst for change (Madanipour, 2017). Lauren Andreas talks about the progressive force that gives local communities and activists a stronger place as participants in urban transformation (Madanipour, 2017). Jennifer Foster discusses its impact in creating new models of development and alternative experiences of space and David Harvey adds that temporary structures act as a response to the crises of vacant spaces with its flexible methods of spatial production which cannot be separated from the processes of production and consumption of space with their political economical and cultural dimensions (Madanipour, 2017).

Gaetano Bertino argues that the use of pop-up environments offers the opportunity to study unconventional solutions and experiments with functions, allowing for a quick and flexible answers and adds that although temporariness clearly indicates short-term experimental development, temporary successful functions can also be incorporated into permanent plans.

reflection

Because of the multiple fields covered by the term temporary use it is important to understand what the term means in this project. Peter Bishop in the book *The temporary city* (2012) argues that “a use is not temporary until it has proved to be so, by disappearing” (Bishop, Williams 2012 page 5) but in this context the intention of user is more important. The reason for the use is temporary, even if reoccurring or a longer intervention of the structure occurs. The intention being temporary simply means the user does not plan to inhabit the space permanently. This is especially important when consid-

ering the structures are intended for the public realm and should avoid privatization.

It is important to note that although in this project the use and placement (in most cases) is temporary the structure in terms of material use and context, meaning the surrounding structures are often permanent. The temporary structures are to complement the permanent, to fill in, test, break up, challenge and aid the process of building more permanent places and to bring the community into the process.

When we look at event architecture where space is built for an activity that is often a pre determined set of time the correlation to temporary architecture is clear. Yet we often seem to use permanent building processes for these events as illustrated in the background and problem set out. Using the benefits that temporary structures have, a scheme where the necessary structures for the event are provided in a way that minimizes the environmental effect, local community is involved in the short and long term and the structures can be used in multitude of ways and settings should be feasible. This can also provide the urban and rural areas flexibility and thus resilience to respond to environmental and social needs might be possible.



Image 2. Paley's upon pilers

Scales and local connection

The discussion regarding the scales that affect architecture and that architecture affects is a topic that is complex and much debated. During the modernist movement in the 1930s many architects felt that architecture should be an overarching and governing body that solves the world into a perfect world (Jodido 2020). This of course had a counter movement mainly the New Urbanism and Architects for social change both more wary of the responsibility of architecture.

The three important scales to consider in regards to event architecture are the scale of the structures themselves, the site as well as the process. The size of the structures come from their program and technical limitations but also from a more theoretical understanding of creating large effect by small interventions. The scale of the site considers the physical area around the event (often town/city) and the scale of the process talks about the social and local identity linked to architectural interventions.

Philip Jodido in his book *Small Architecture* argues that when the project becomes larger the complexity and bureaucracy marginalises the architects say and impact in the project (Jodido 2020). For context it has to be mentioned that this most likely was written from an western, American perspective but the concept of diminished decision making power of the architect due to budget, commercial, political ect. decisions might diminish in the project can be applied further although in different context architects take a larger role but in the Swedish context where the project is placed this is true to an extent.

Andres Lepik in his book *Small scale Big Scale, New architecture of social engagement* argues that the real power of architects as shapers of environment has eroded. "As the ebbs and flows of globalization have brought both development and its discontents to nearly every corner of the planet, the role of the architects in the spatial arrangements of global capital and concomitant commodification of space have been left undetermined" (Lepik, 2010 page 8).

The trend of globalisation and global capital often has a cost for local and traditional communities, something Kenneth Frampton discusses when describing Local regionalism. He argues for an *arriere-garde* role, someone that stays away from both the optimization of advanced technology and the ever present tendency to repress into nostalgic historicism or the glibly decorative (Frampton 1983). In simple terms we should work in the in-between, using technology (to an extend) and our spatial expertise to inform or support the local level from a global perspective but not to please the global ideology. This pleasing is something that Lepik also points out, "in too many cases, the role of architects in recent years has been relegated to giving form to the landscapes and cityscapes shaped by larger forces, notably of capital flows in a globalist world" (Lepik 2010, page 9) . Architecture has already fallen into the lure of modernistic ideals and overreach of power once, and smaller projects seem to be a way to counteract and criticise the field.

To that extent smaller community led projects also tend to have a more positive social effects on the local community like Svättekyran Sauna in Gothenburg since their are built and designed often for or by the community. Smaller projects, in physical footprint wise, tend to lend themselves for a freer design process for the architect, due to the lack of multiple stakeholders and interest groups and a more active participation from the community's side. This is due to the difficulties brought on by smaller budgets and benefits of smaller work groups. Some examples of this are the unfinished low-income houses in Iquique by Elemental and Philip Johnson Study (project). They also tend to have a larger social impact on the community. Small scale structures are often used when discussing temporary and mobile structures that aim to test, support, provoke or invigorate areas in the urban and rural areas as mentioned in the temporary architecture chapter.

This project is built on the concept of illustrating and supporting long term larger scale implications with small scale physical interventions that are there to support the event and then are 'released' into the public domain and can used and interpretation by the community to be used for their benefit.

Building upon Philip Jodido s thinking around the diminished role of an architect in large projects I wonder if it could be understood that if a person intimately involved and often paid for in the process such as an architect is left out surely the local community who does not have a direct input (financial, ownership, political say) in most cases is also left out or given a minor role through public hearings or costly judicial procedures. This might be due to the globalization world we live in.

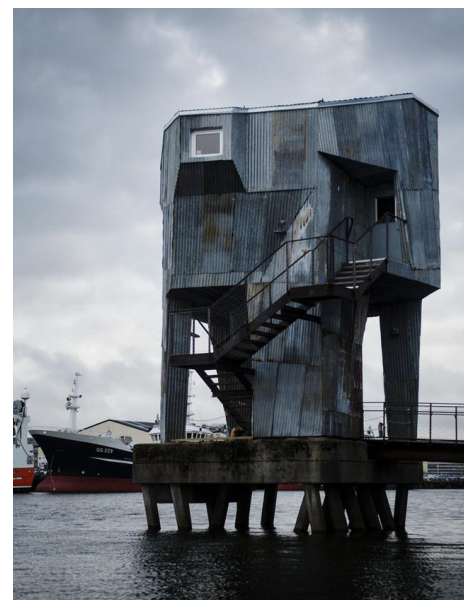

Image 3 .Svättekyran sauna, Gothenburg

Resilience

“Individual piece of architecture over time is a constantly changing artefact consisting of multiple systems with different life cycles, transformative capacities and required variability” (Laboy, Fannon, 2016, page 47)

There are multiple subcategories of resilience but at its core it is the capacity of a system to deal with change and continue to develop. To be able to use shocks and changes to create renewal and new ways of thinking (Stockholm resilience centre 2014). There are three main categories of resilience: engineering-, ecological-, and adaptive resilience (see image 4). Engineering resilience has the capacity to react to the short term disturbances but has the intent to turn back into the pre state. Ecological resilience has the same capacity and additionally the capacity to move to different set up systems. They both suffer from the difficulty of trying to move into set states where as adaptive resilience has the possibility to react and return to former states and importantly it also has the possibility to change the different states of the system towards upcoming pressures (Stockholm resilience centre 2014).

Here the importance of flexibility becomes evident. Structures should respond to current needs but also predict and plan for the possible future changes. Predicting future changes and creating room for flexibility is something that Laboy and Fannon also reflect on in their book Resilience theory and Praxis (2016). They argue that resilience should acknowledge that many of these assumptions will not remain valid for long, that conditions are changing and models often fail to predict the complexity of dynamic interaction (Laboy, Fannon, 2016). Yet the design shouldn't become generic to not strip architecture from its cultural value.

This is why they have created a three pronged approach for designing for adaptive resilience. The design process should take into consideration changing concepts, changing artefacts and changing contexts. Changing concept means the transformability of the structures, changing artefacts mean shearing life cycles and changing context means plan-

ning for the uncertainty. They surmise that in this way “the alternative model of programmatic adaptability based on adaptive resilience would focus on ways the essentially architecture invites and enables the adaptive reuse of the future.” (Laboy, Fannon, 2016 page 49)

reflection

There is an evident need for flexibility in event spaces and in particular in the case study of Falun. Most of these areas are rural and live a quiet existence most of the time. In case of Falun the town has around 40 thousand permanent inhabitants, yet the event brings anywhere from 20 to 100 thousand visitors to the town. The increased human activity on site produces an increase of financial, housing, food, medical and cultural needs. On a larger scale the future of these places (like any settlement) is in flux, some might be lost due to climate change, some might become a tech or industrial hub, some might have financial or ecological tragedies. This is why transforming the event to implement resilience with a small physical footprint on the area can be seen as a large benefit at a low cost.

With this, of course, comes a complex planning phase where two existing (on and off season) qualities have to be designed with possible future challenges in mind.



Image 4 .Types of resilience

Critical regionalism and event management

"The phenomenon of universalization, while being all advancement of mankind, at the same time constitutes a sort of subtle destruction, not only of traditional cultures, which might not be irreparably wrong, but also of what I shall call for the time being the creative nucleus of great cultures.."
– Paul Ricouer, History and truth, quoted in Postmodernism: A reader, Docherty 1993 (page 268)

Critical regionalism was conceived as an alternative to post modernism which some had seen to fall into the same pitfalls as modernism had (Lefaivre 2003). The term itself was developed to give this movement a theoretical framework (Lefaivre 2003). At its core it intends to be a bottom up approach to design, that recognizes the value of the identity of the physical, social and cultural situation, rather than mindlessly imposing narcissistic formulas from the top down.

Liane Lefaivre and Alexander Tzonis in their book Critical regionalism, Architecture and Identity in a globalized world (2003) argue that "the unanticipated impact of globalism showed that if it were left unchecked, it would be economically costly, ecologically distractive and calamitous to the human community."
reflection

Where Critical Regionalism has an interest in, for the lack of a better word, a compromise between the local and global, meaning using the beneficial aspect of both and letting both grow in parallel I see that event management would benefit from a similar approach. Rather than propping up the local in nice postcards or ceremonial roles, something that in critical regionalism I think Kenneth Frampton might say is a simple minded attempt to revive the hypothetical forms of a lost vernacular a true involvement of the location should be considered. In the immediate event time in representation and in the long term in ownership and impact. This again would move power away from the current system, like in critical regionalism by giving priority to the identity of the particular rather than to the universal dogmas. (Lefaivre 2003).

Trying not to be callous I see the globalized event organisation to have the same effect as unchecked globalisation. If we look at Fifa, FIA, Olympics or FIS creating homogeneity rules they from the distance disregard the local physical placement and this in turn has turned into costly operation where the location is developed to fit these narrow boxes. This is particularly interesting when many of the organisation place their event on the global scale, ending up in a situation where even when moving between cultures their physical context remains largely the same. On the other hand the events are often funded by the private sector, which in all fairness is a vital lifeline for the events, has been known to exploit or disregard the local community.

Whilst the parallels drawn larger questions into the creation of globalized events this project aims to take a facet of the problem and illustrate how in an architectural way the built structures can support both the local community and the event.

Framing the project

Temporary architecture

The use of temporary structures in relation to event architecture might seem evident when discussing the length of time the events occurs in but this project aims to take an approach where time is stretched beyond the event. When the organisations discuss time after the event their aim is to build permanent structures, believing this brings prosperity. I believe leaning into the temporary in term of use is a benefit. Like mentioned this method often serves to provoke and experiment but leaves a minimal footprint. Of course everything can not be temporary and there is something to be said about the emotional attachment we have to places but when we insert temporariness into the permanent we might be able to see a process where power dynamics change.

that balance between two different forces, the event managers and local community creates a rich yet difficult field to navigate.

Scales and local connection

Since the intention of the project is to provide structures for the public domain smaller scale structures could be an opportunity to not get trapped in a formalised public space that is controlled by one actor. Furthermore small scale structures and temporary use of the spaces provides the opportunity to skip planning and permissions thus creating structures that aim to be easily accessible and provide ad hoc social interaction for the community. Thus the role of the designer might be just to design the space in a way to suggest use and fits into the context but is otherwise governed by the public.

Resilience

When translating some of the terms related to resilience to the project scale *changing concept* becomes *mobility*, *changing artefacts* become *multi use* and *changing context* becomes *flexibility*. As discussed previously temporary architecture and small scale interventions already tend to lean towards processes that have resilient aspects so the aim is to understand how to achieve adaptive resilience.

Critical regionalism

Drawing parallels between critical regionalism and event management the complexity of designing structures

Going forwards

There are multiple overlaps between the different theories that create the framework and guide the project. By looking at the benefits each theory mentioned could have in different phases of the design, the theoretical framework serves to inform the project from a holistic to a practical level.

The temporary approach is the cornerstone of the design. This should be referenced to when making decision as to how the materials are combined, what they are connected to and how specific the design are.

At the same time we need to consider the scale of the structures. Although some of the limitations are set by the physical surroundings the larger impact, changing conditions and community ownership should be considered when deciding on how the structures are placed, moved and appropriated.

This all should be done and lead to a design that provides resilience for the area through physical forms since the environmental and social elements are ever changing.

Yet the design can not end up being too universal as to not lose the local expression in architecture or in the program as to design a space too flexible. Rather the design needs to guide the user and give them a sense of place.

Current building process for Fis cross country event

Currently Fis makes the rules and homogenises the events disregarding the local context. Most of the structures are owned by private operators and are done through permanent processes whos long term plans only apply to the events.

Understanding who holds power and where.

stakeholders

- Fis
- Private sector
- Public sector
- Local community

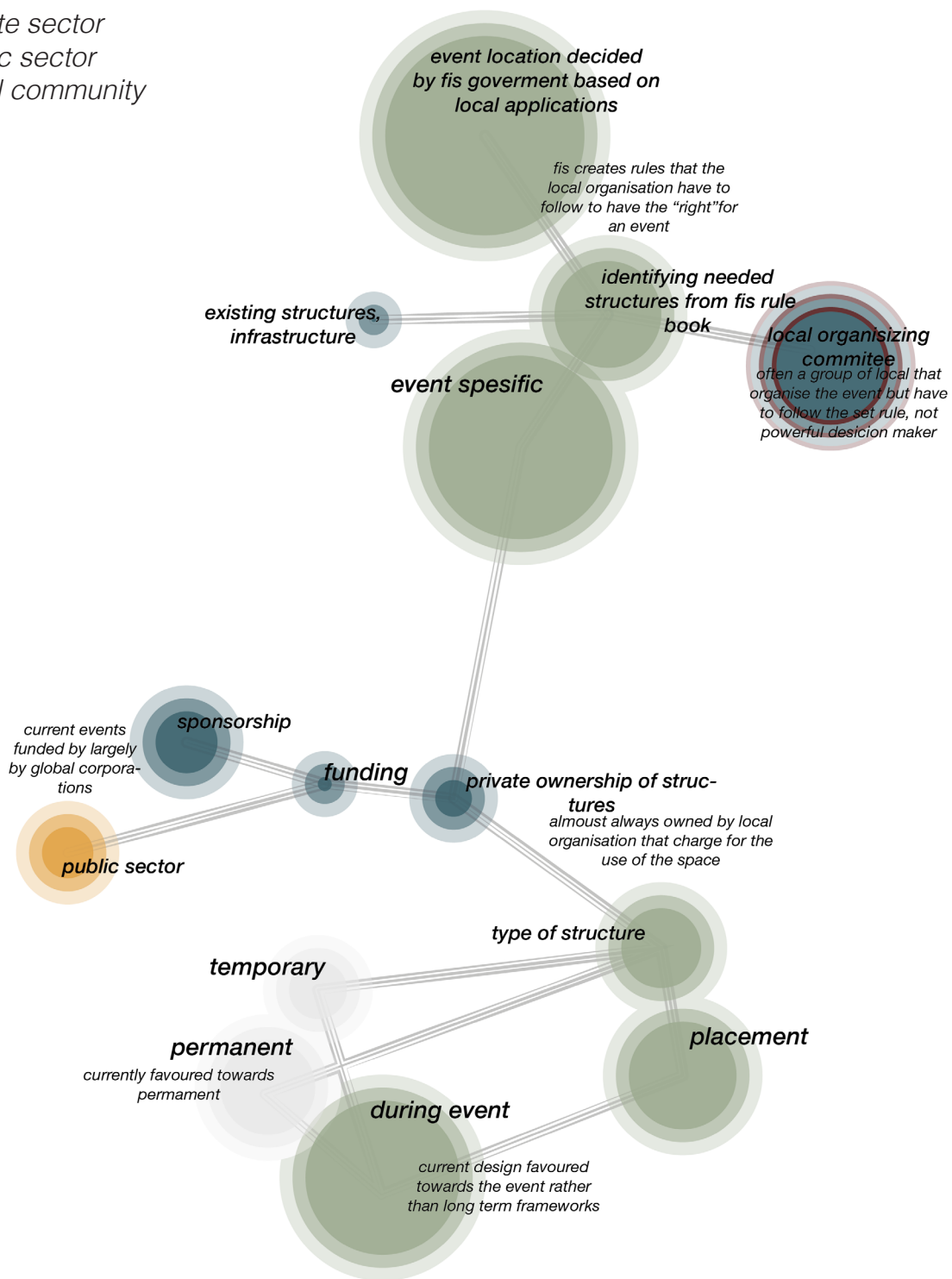





case study

Falun

Falun is a smaller town in the Dalarna region of Sweden. Falun has for a long time held a special place in Swedes hearts and first became know for its copper mine that was the main income of the town. Nowadays the mine and the history surrounding it serves as the main attraction of Falun and is a popular tourist destination. The mine area and some of the city are a UNESCO World Heritage area which shows the importance of Falun in the national and global level. Falun also is know as the main cross country ski centre of Sweden. Even with its relatively small size of 40 000 inhabitants the town has produced many of Sweden's best skiers and functions as one of the traditional Fis ski world cup hosts early. There is also a University in Falun that functions with the nearby city of Borlänge and has 18 000 students making the town have a student town aspect.

Whilst visiting Falun the main take-away was the peacefulness of the town. The town centre is compacted in a small area that a river runs through but even in the town centre the high streets feel almost vacant. All this changes when a large event is in town and the multiple car parks that sit empty most of the time are filled by visitors that come to see the ski competitions. The architecture in Falun ranges from the historic Falu red protected wood houses to the stone building in the centre, large old private villas and steel and metal structures towards Lugnet where most of the events are held.

In the recent history Falun has been

12 year climate period

Average temperature (January) -3 c
 Average temperature rise in a year (January) 0.16

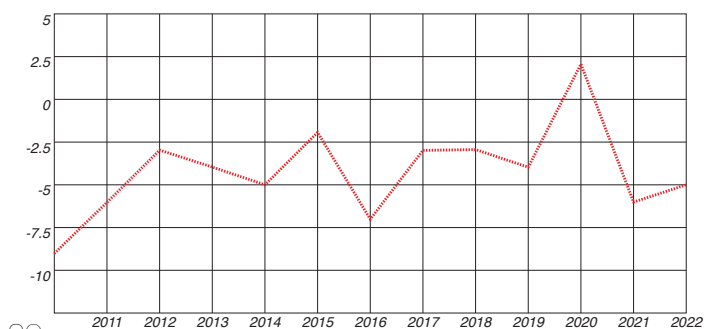

the host of Fis world championships 2015 and will host the same event in 2027 and is the most likely location for skiing in the case of a Swedish Olympic bid. These are similar to a world cup event but at a magnified scale. Where World cup brings around 20 000 visitors during a weekend world championship brings 300 000 over a twelve day period. In addition the Dalarna region is know for hosting multiple outdoor events such as Vasaloppet and cultural events such as Swedish dance band week

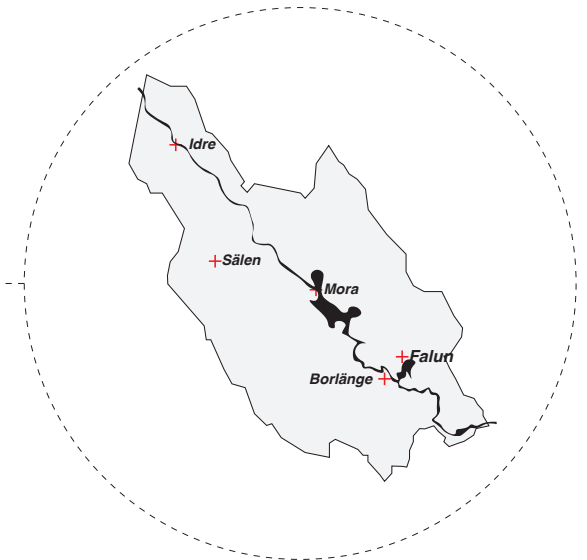
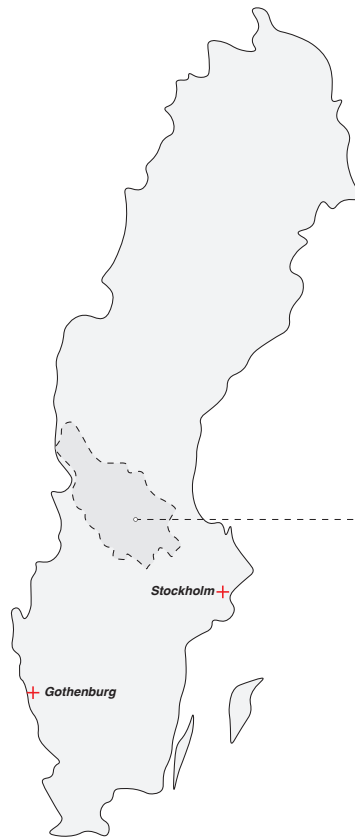

Average snow days during study period 85
 Average lost snow days in a year -5.0

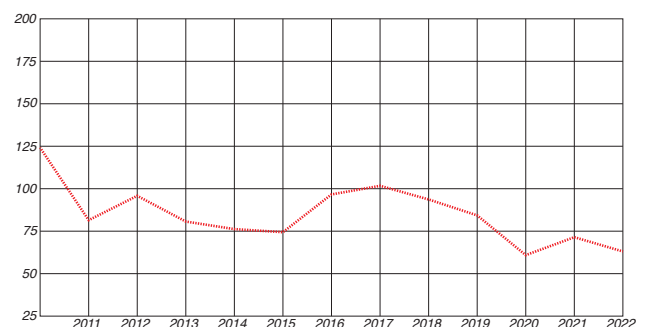



Falun 2015

Falun 2015 was the largest ski event organized in the city, and below some statistics of the event and its organisation as well as a study of the locations viability for further events due to climate change.

Visitors:	281 600
Affiliated event visitors:	70 000
Competitors :	700
Main sponsors:	Stora Enso, Viesmann, Audi,
Investment:	22.3 million euros
Gross Revenue:	4.21 million euros
Main projects undertaken:	New ski jump towers upgrade of stadium and ski tracks, in town stage

Municipal events

Each structure due to their mobility could be moved to help other events in the surrounding areas when needed

Dalarna events

Vasaloppet	Large events
Vansbrosimning	Sälen/Mora
Swedish dance band week	Vansbro
Lilla skidspelen	Malung
	Falun

Continuous events

- Cycling
- Hiking
- Skiing

Possible future events

- Outdoor art
- Outdoor concert
- light show
- Festival (music, food, art)
- Company conference
- Political meeting

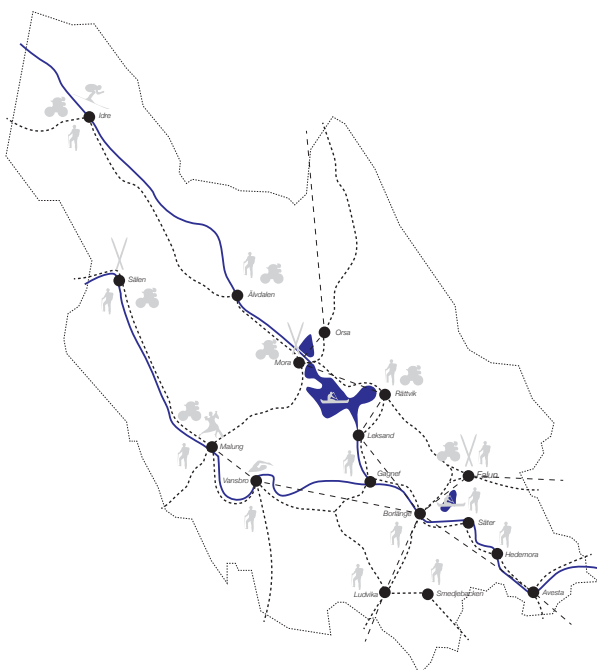

Falun city: important places around town

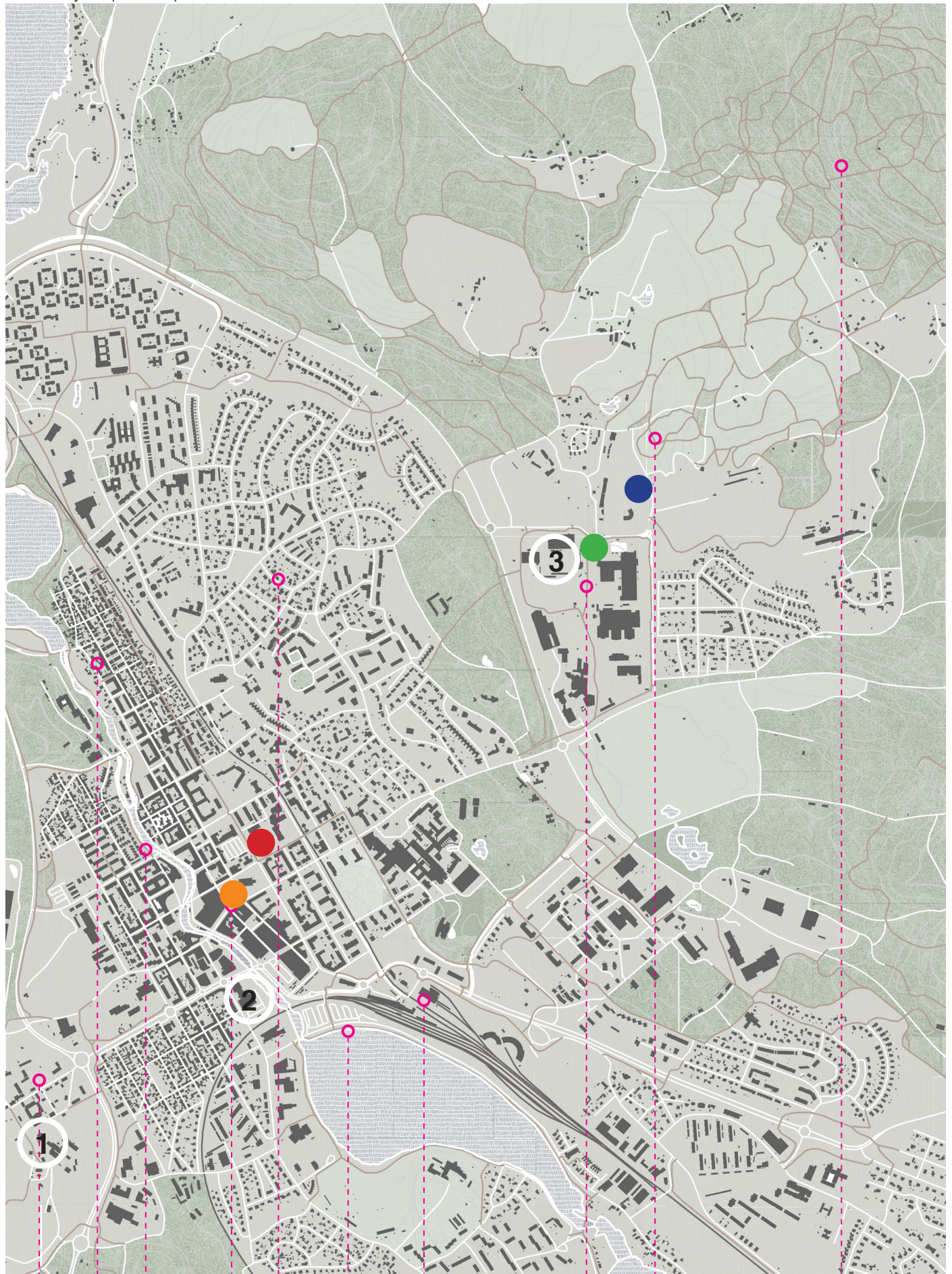

Copper mine

City square

Train station

Nature reserve

Historic residential
area

Residential

Sports and faculties area

Popular river walk

Popular lake walk

Ski tracks and stadium

Current event placement



Stage

The main stage where artist performance, opening and closing ceremonies and prize awarding is performed is built on Stora Torget, the main square in town. This location has become a tradition to celebrate and functions as the main event space after the race events in Lugnet

Build structure: temporary stage.



Pavilion

The after ski pavilion is built on a car park in the city centre close to the stage. Its purpose is to provide a social area where visitors can meet.

Build structure: temporary covered and gated area



Stands

At the entrance to the ski stadium stands for food and other commerce are built to support the event because the area lacks commercial space during an influx of people.

Build structure: lightweight stands at varying scales.



Commentator boxes

Commentator boxes are placed next to the ski stadium for media purposes. They are brought to the site from other regions.

Build structures: (lorried in small “boxes”)

Current off season placement

1 Copper mine

The copper mine that has Unesco world heritage status functions as a large tourism attraction during the summer months. During winter the site is closed.

2 Theatre

The Theatre is located in the city centre and is the main formal cultural event space in the city

3 Sports hall

The sports facilities around Lugnet host smaller local and national formal events year round

Development

To be able to identify which structures should be built and for which programs a deeper study into aspect of the *Proposed design process translated into the case study of Falun on page 23* had to be done.

Firstly the different organisations and their needs had to be looked in details to establish programmatic needs. The needs were then sorted into themes to combine similar need. These themes were then translated into architectural structures which discuss each theme.



Looking at the what the community and event organisers have self identified as future development areas at physical and social levels through their documentations (Fis questionnaire, Falu kommun overview plans and region Dalarna agenda 2030)

Region dalarna

(Agenda 2030)

Sturctures and aspect the municiplaity has identified need to be involved in long term planning

- Healthcare access ●
- Cultural access ●
- Co creation
- Equality ●
- Elderly access ●
- Business space ●
- Student housing ●

 Public

 Cultural

 Private



Stage

Combines uses that need a public space and elavation



Sauna

Combines uses and aspect to provide cultural and social space



Maja

Combines uses where private and living space is needed

Project specific considerations

Lightweight structures that are mobile in their nature but permanent in material use to minimise material use and maximise transportation. The structures should be made as accessible as possible (by accessible the main concern in use of use by the community not physical accessibility since the locations of the structures or not accessible in their nature (for example, middle of forest). The ownership should be planned in advance even if its aimed for the public domain and some aim to tighten urban areas. connect to sources using text

Structures, typologies, locations

To gain more insight into each structure their user, placements where looked at.

The users change when the program changes and it was important to established a clear user to be able to design program specific spaces.

The placement of the structure also changes with the program to where it is needed and establishing a clear placement for each serves for illustration purposes and to point out voids and opportunities in the physical space in Falun.

After the placement was established to surrounding context was identified and used as the design base when discussing the appearance of the structures.

Structure	User during event	Users rest of time	Placement of
 Pavilion	visitor	artist, company, group	city park
 Stand	visitor, skier	company , healthcare	road
 Stage	skier	activist, politician, musician	town square
 Sauna	visitor	local community	by the river
 Maja	visitor	visitor, vulnerable person	car parks

during event	Placement rest of time	Context during event	Context rest of time
		materials, colour palette, detail bank	
	landmark	urban	historic
	empty plot	event	urban
	empty plot	event	urban
	ski tracks	historic	event
	hiking trails	urban	event

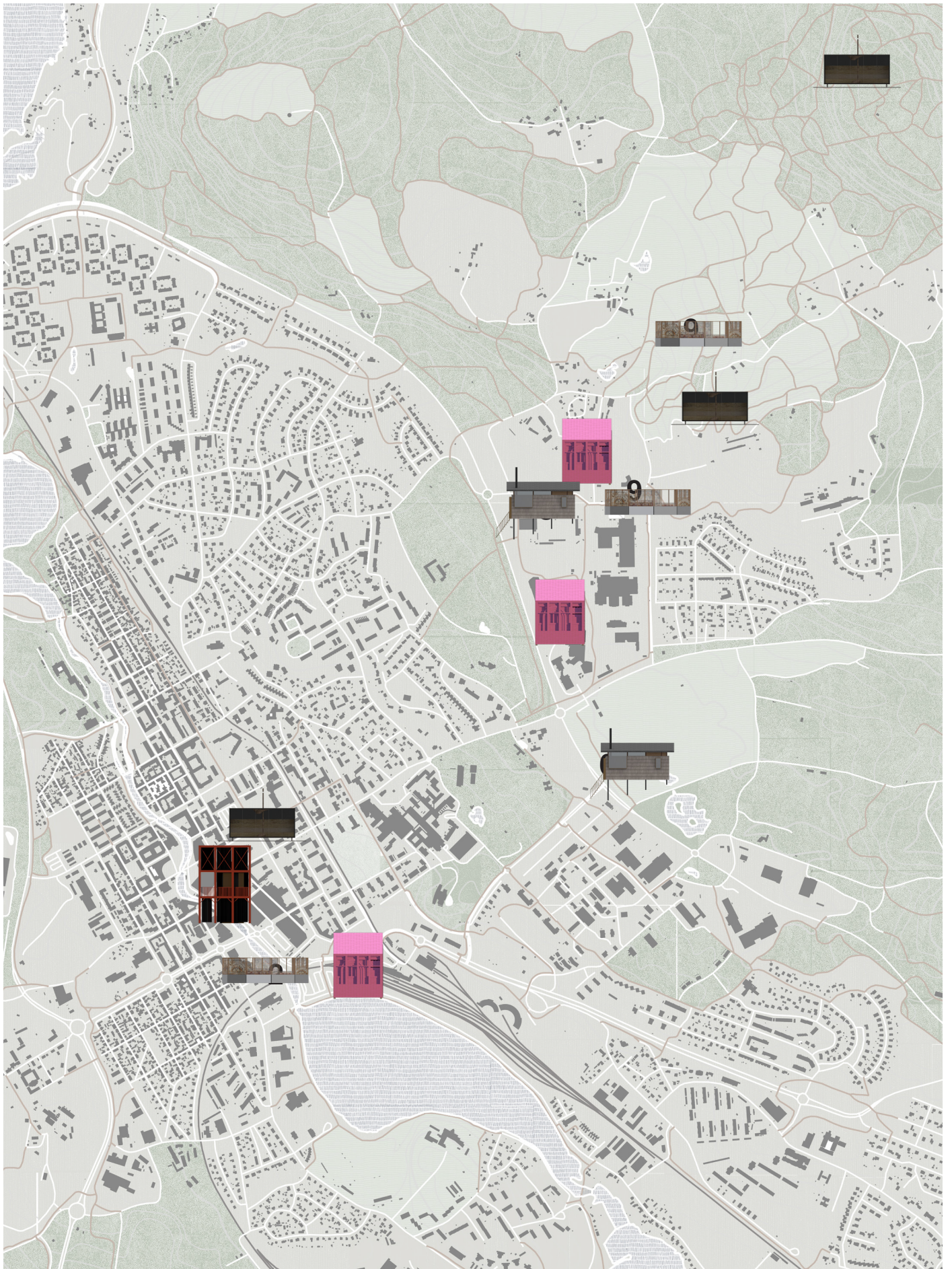

Proposed event placement



Stand

Information

Placing one stand that is used as information stand close to the buss and train station since most visitors will arrive using public transport, creates a clear path and guidance to the city.

Commerce

Placing mobile commercial space in and around the event space to provide local companies retail space that has a lower threshold and larger walk in ration.

Commentator

Placing new commentator boxes where the organisation has identified.



Pavilion

Exhibition

Using one of the cities most attractive areas that is currently used as a car park by the river to set up a pavilion where local art, innovations and products can be displayed and promoted during the formal event.

After ski

Using a city centre park to set up a larger, central after ski where visitor can spend time after the competitions.



Stage

Stage

Building on the heritage of the ski events by placing a stage on Stora torget

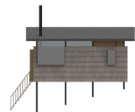

Maja

Temporary hotel

Placing mobile cabins on a non production field close to the event space to provide much needed accommodation during the events.

Ski wax

Using what the organisation has already identified to place ski wax cabins .

Audience

Building the visitor experience by providing a space that serves the needs of the audience such as, food, medical, heat, wc, media.



Sauna

Sauna

Creating a enjoyable cultural experience in the city centre and competition area. The space can also serve a heat source during colder moments.

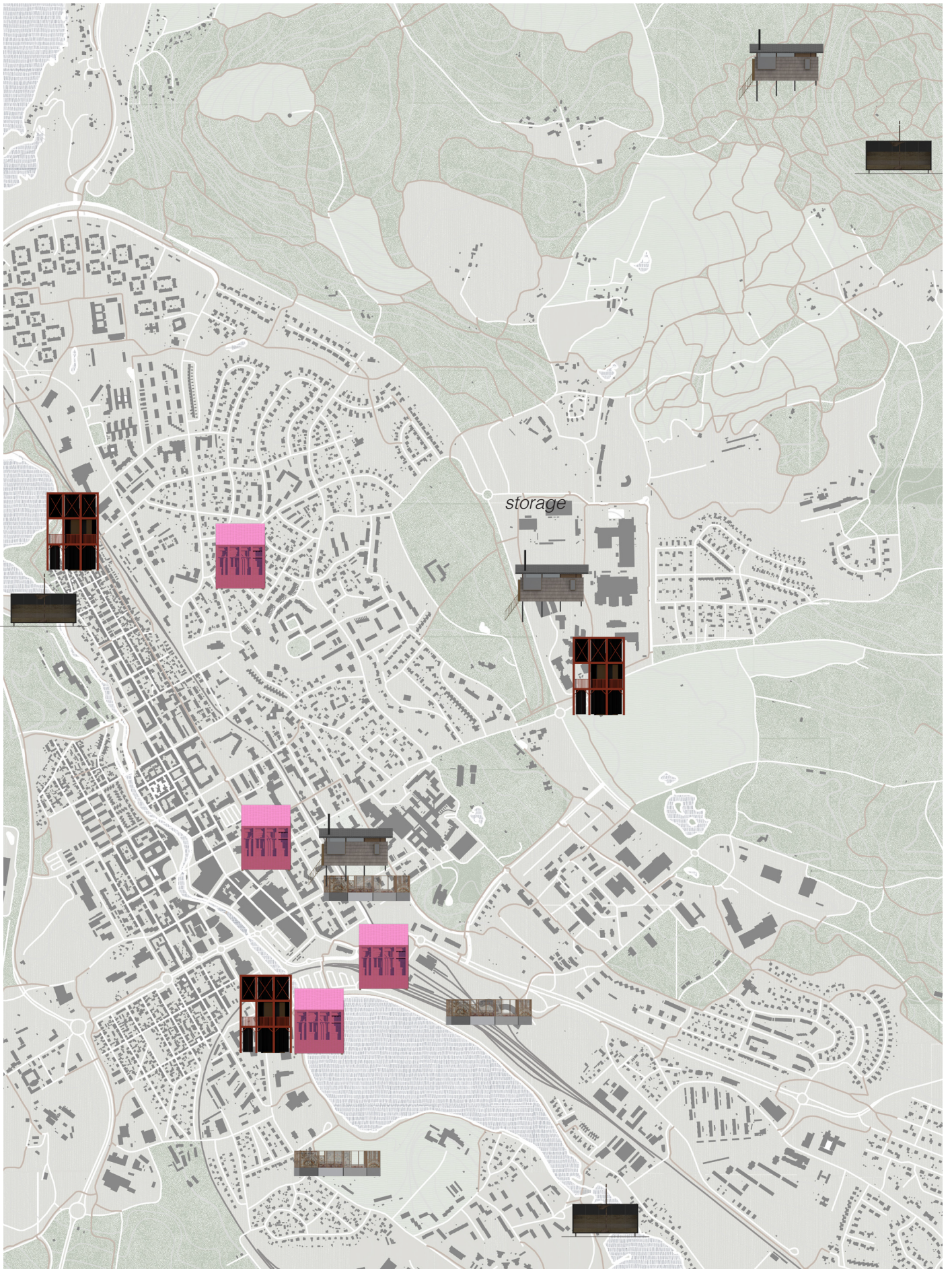

Proposed off season placement

Stand



Cafe

Using the stand in the residential areas to provide low threshold commercial spaces.

Start up (cycle repair, take away ect.)

Using the stands qualities to provide low risk space for individuals to try new business.

Remote office

Using the stand to create office, study space for nomads and locals.

Temporary medical centre

The stands can be used to provide medical check up or vaccination centre to respond to arising issues and demographical challenges.



Pavilion

Exhibition

Creating non commercial temporary cultural space in the town (placement and time) based on users wants.

Town hall

Using the pavilion to create a town hall format where political activity and openness is advocated for.

Open air fair

Using the pavilion to provide a more formal space for the community to organize fairs and markets.

Cinema

The pavilion can be used to organise open air cinema and movie festivals for a more open, community led culture.



Stage

Music concert

Creating free outdoor musical venues for new artist to perform in a semi formal setting.

Protest

The stage can be used to organise protests and rallies where for a more formal and hopefully acknowledged way.

Outdoor theatre

The stage can be used by local improv or community theatre groups for free performance places.

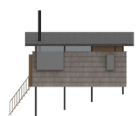

Maja

Safe house

Maja can be used to provide temporary shelter for individuals during a catastrophe such as a fire, or vulnerable individual to provide a safe space.

Shelter

Maja can be placed in the forest to promote longer hiking trips and provide overnight space.

Temporary housing

Majas can be deployed to provide temporary housing for students, elderly, immigrants to respond to situations.



Sauna

Sauna can be placed in the urban to create a public, free cultural experience or in nature for a more private experience.

Local typologies

Looking at the atmospheric experience as well as the architectural forms in the urban areas of Falun to create a kit to be used when a design is identified to be housed in this typology

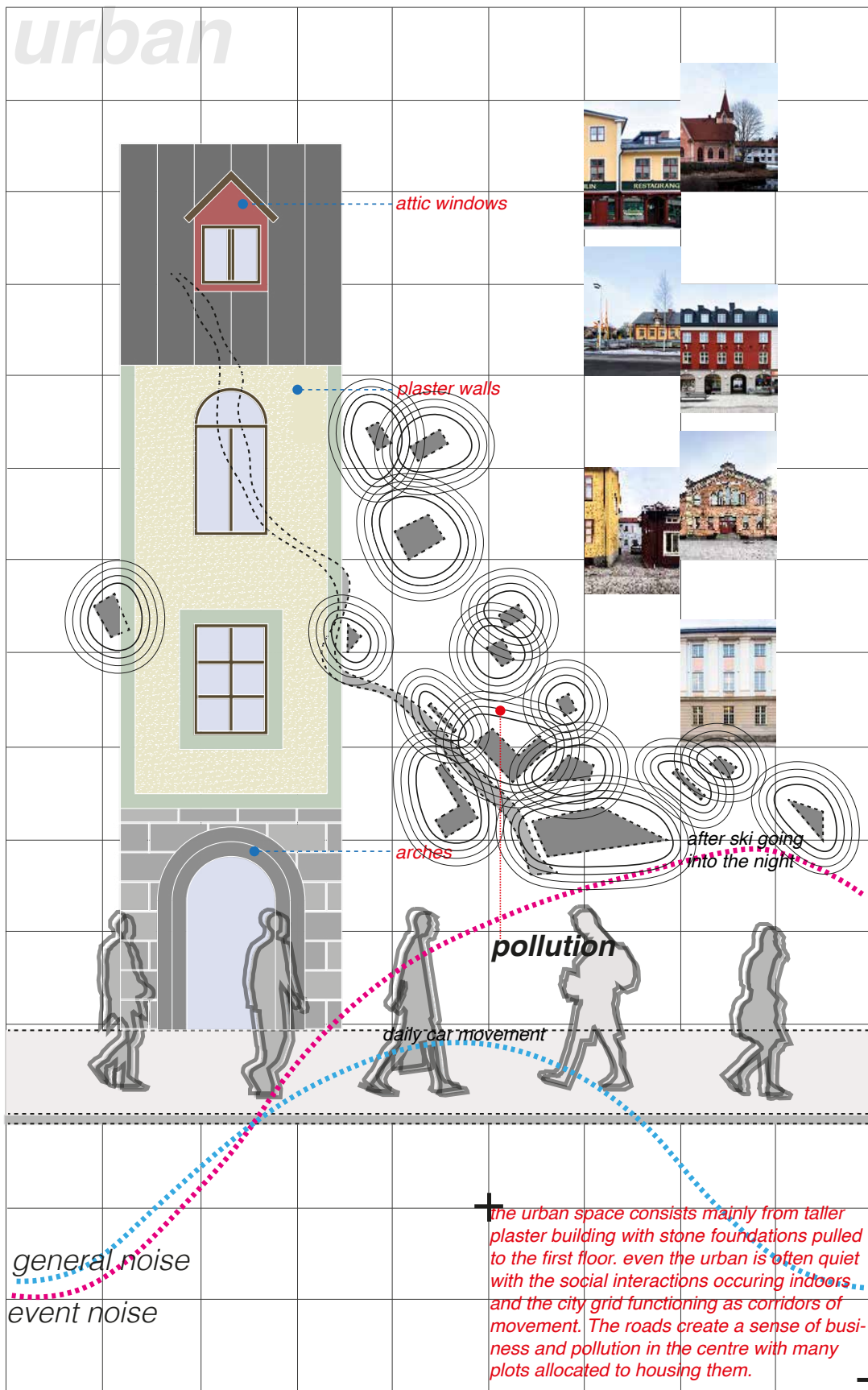

Looking at the atmospheric experience as well as the architectural forms in the historic areas of Falun to create a kit to be used when a design is identified to be housed in this typology

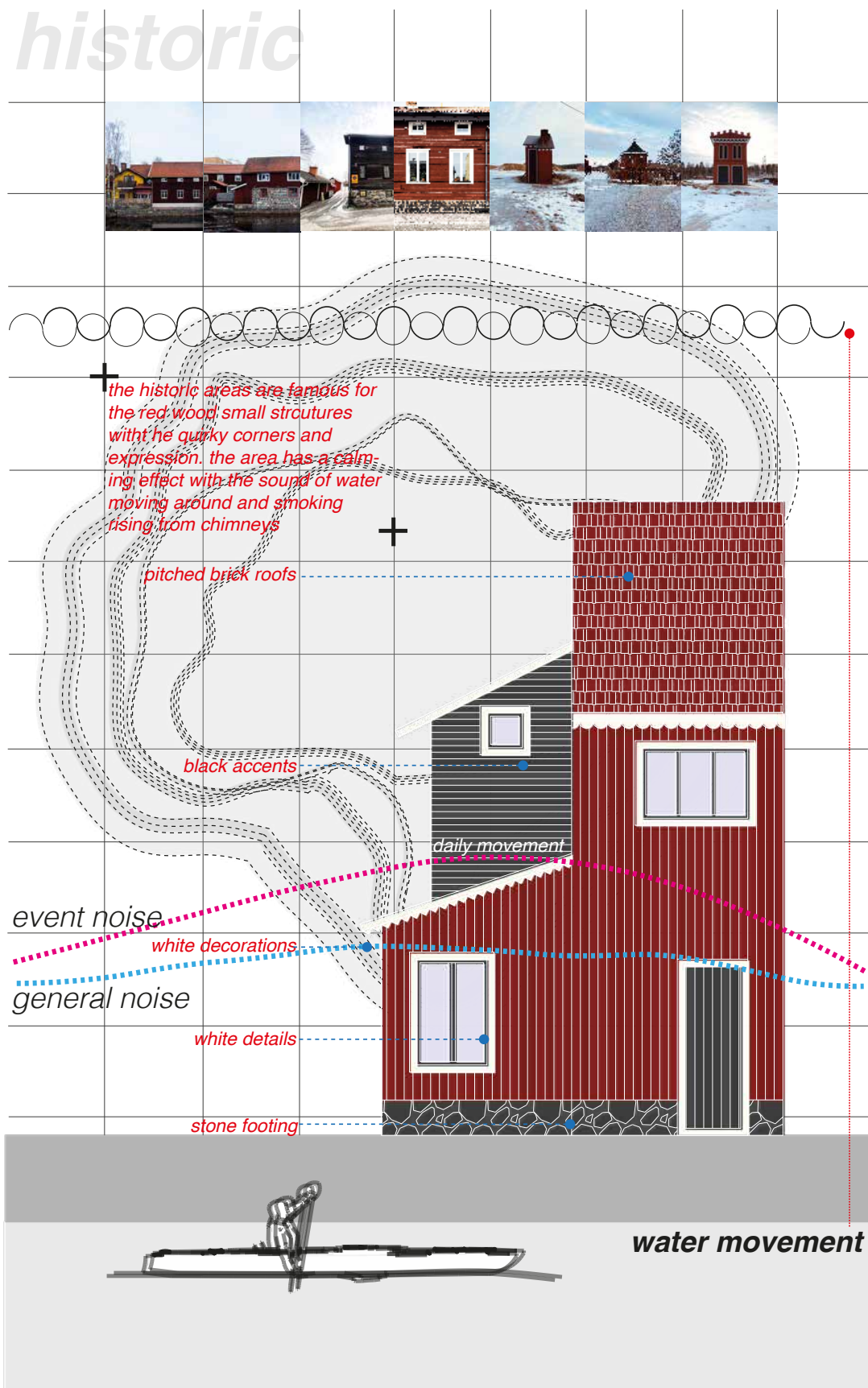

Looking at the atmospheric experience as well as the architectural forms in the event areas of Falun to create a kit to be used when a design is identified to be housed in this typology

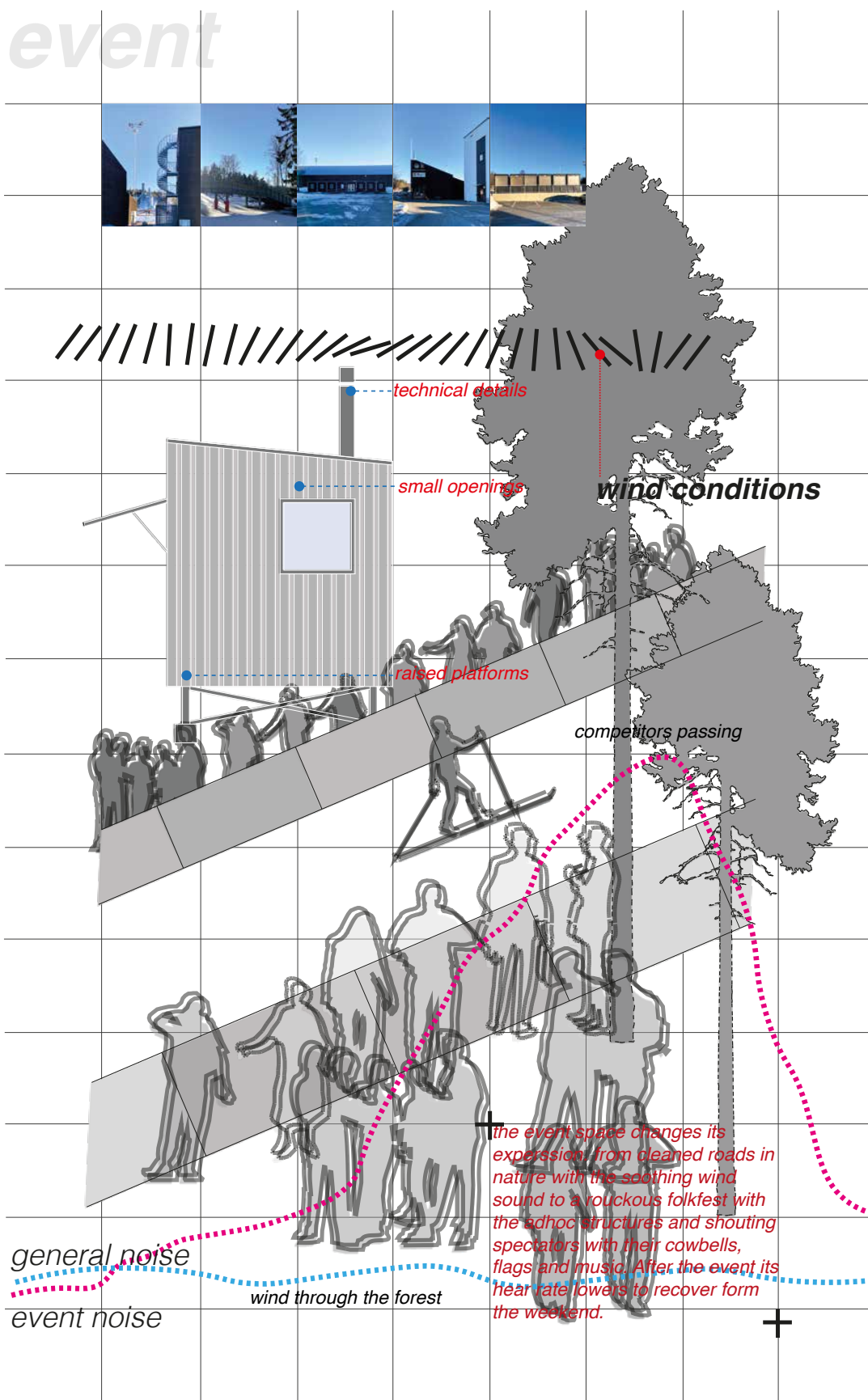

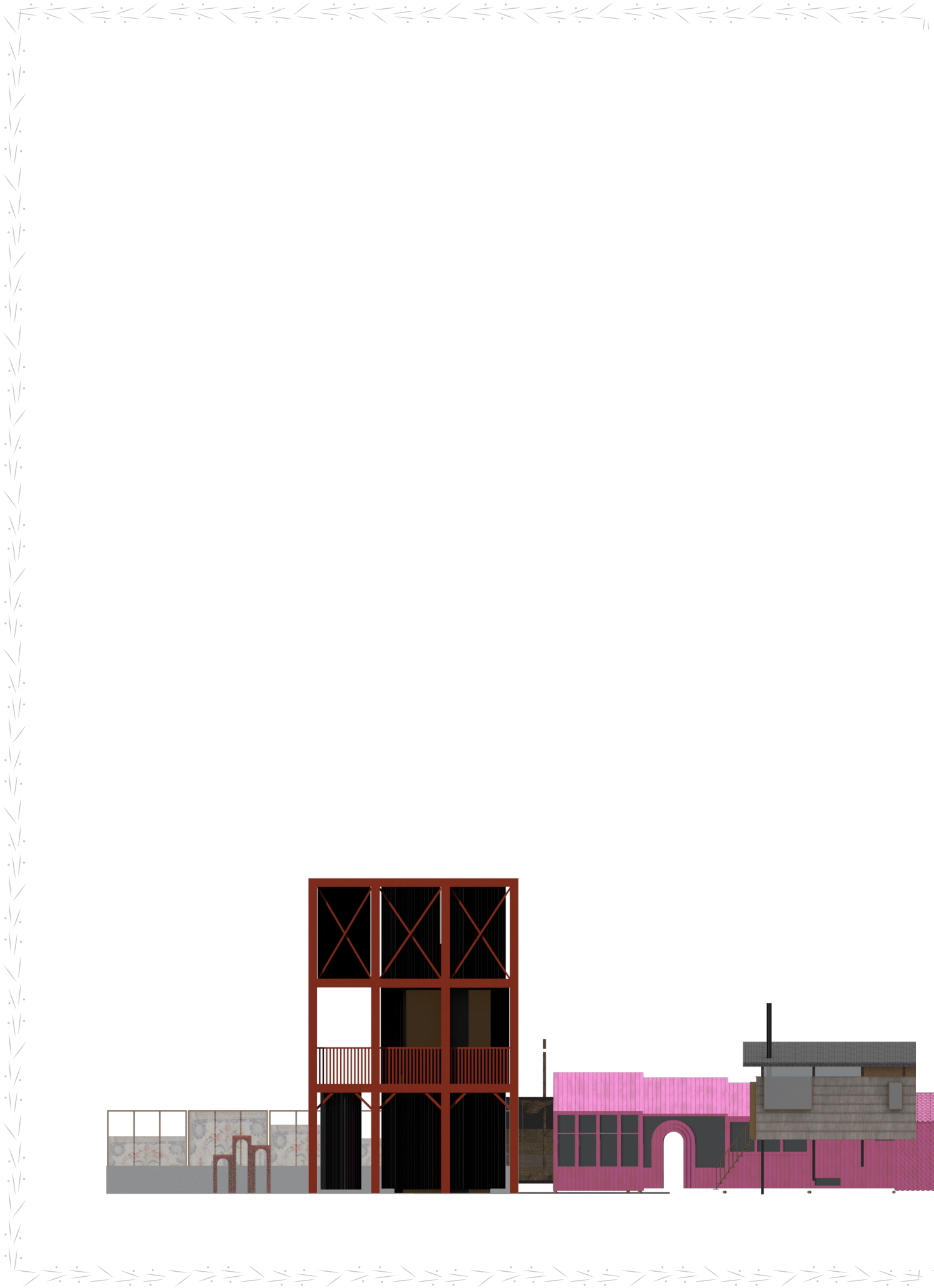

Structures

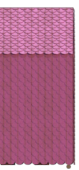

Specific sites

Showing the placement used in illustrations for each structure during the event and after and there relation to I Identified typologies

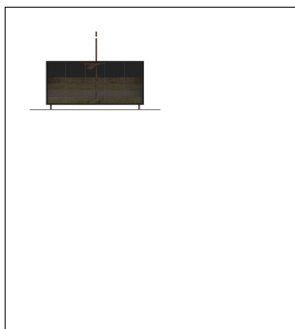

Sauna

Located firmly in the **event** place during the event to provide heat and a specific cultural experience for the event and then after the event it is moved to the park along the river/lake walk to provide a much needed space near the swimming and **historic** areas that can also be used as a space that frames a specific view.



Sand

Located firmly inside the formal **event** place during the event to provide commercial space for the visitors needs during the event and afterwards can be rented out by the community and placed in the **urban** voids for start-ups , remote office and more.

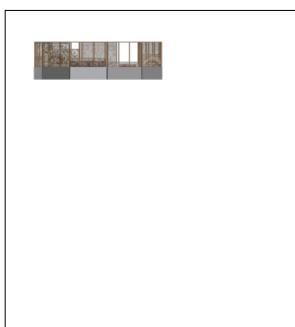

Pavilion

Used to create semi formal public space during the event for the visitors to enjoy an after party, food and seating inside the **event** space and afterwards stored and collected by individuals when needed to create for example a town hall or exhibition, the pavilions based derives from the **historic** aspects of Falun to create a connection between the old and new Falun

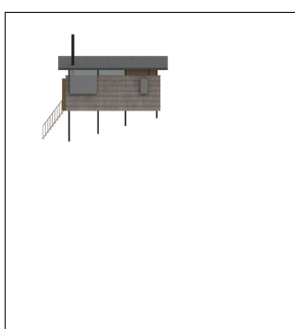

Maja

During the event Maja creates needed housing for the **event** visitors and can also be used a waxing cabin for the competitors. Afterwards it functions as a emergency housing during catastrophes and vulnerable times in the **urban** city and can be sent for other events or placed in nature for hikers to use.

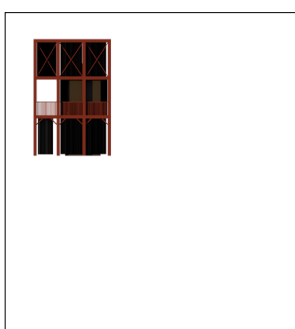

Stage

During the event the individual stages are gathered in the **urban** town square to create a larger stage for celebrations whilst individually they are placed around the **historic** areas to support free and unrestricted cultural experiences

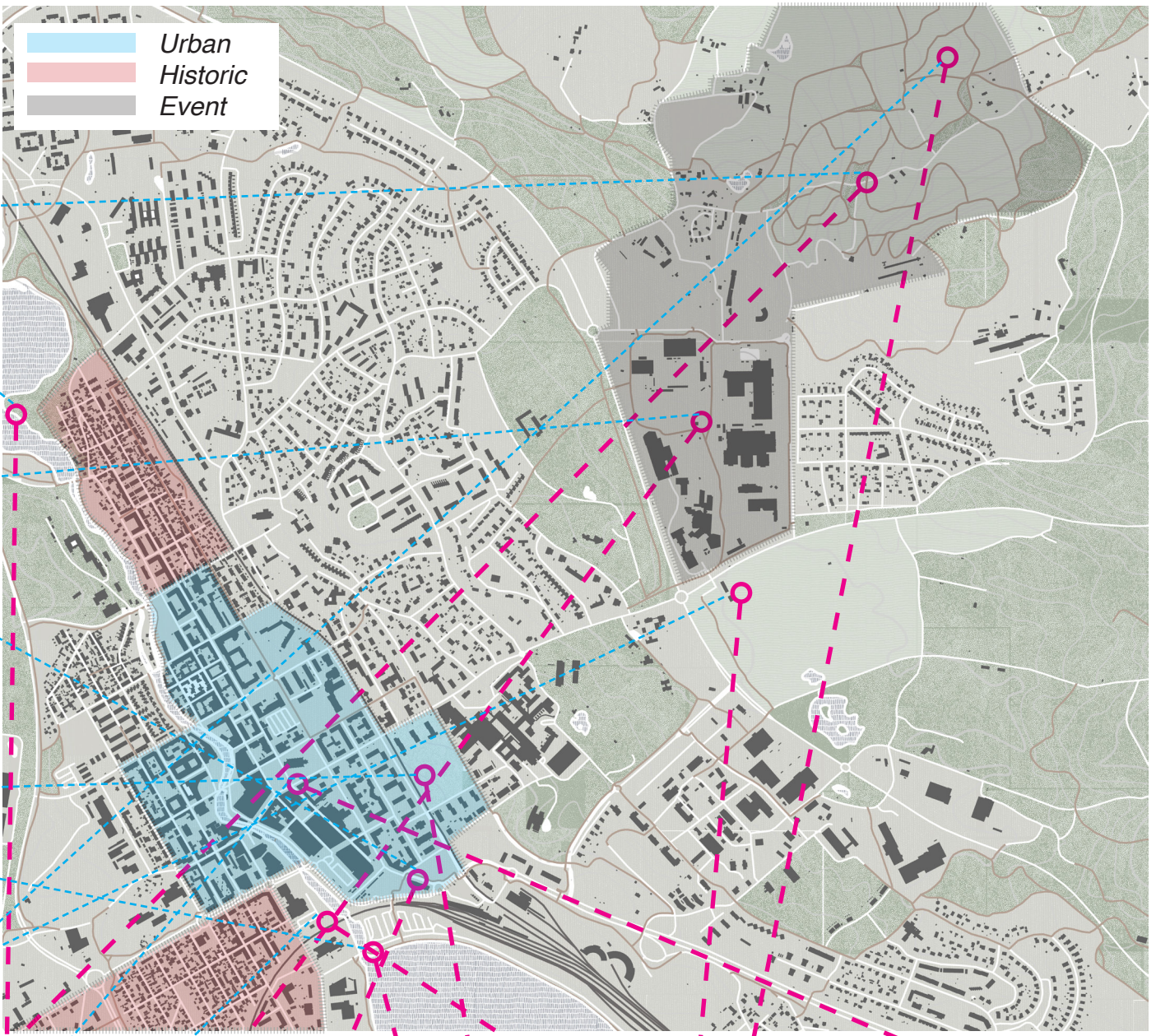

during event

after event

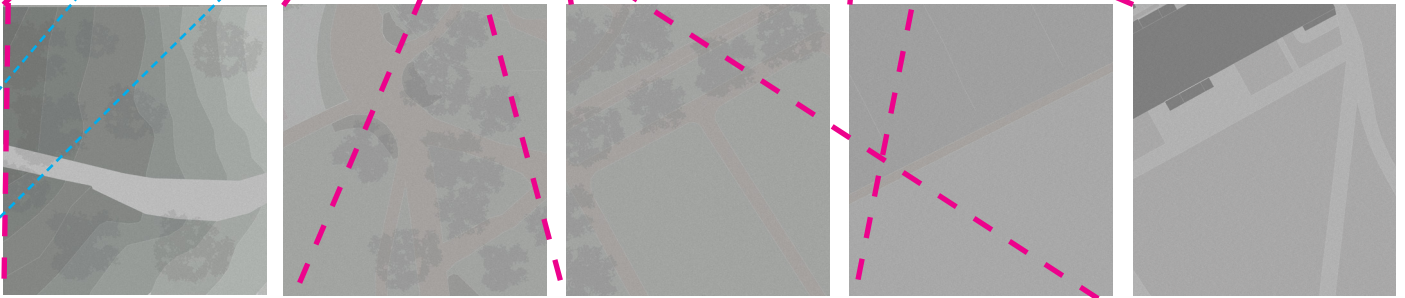

sauna

stand

pavilion

maja

stage

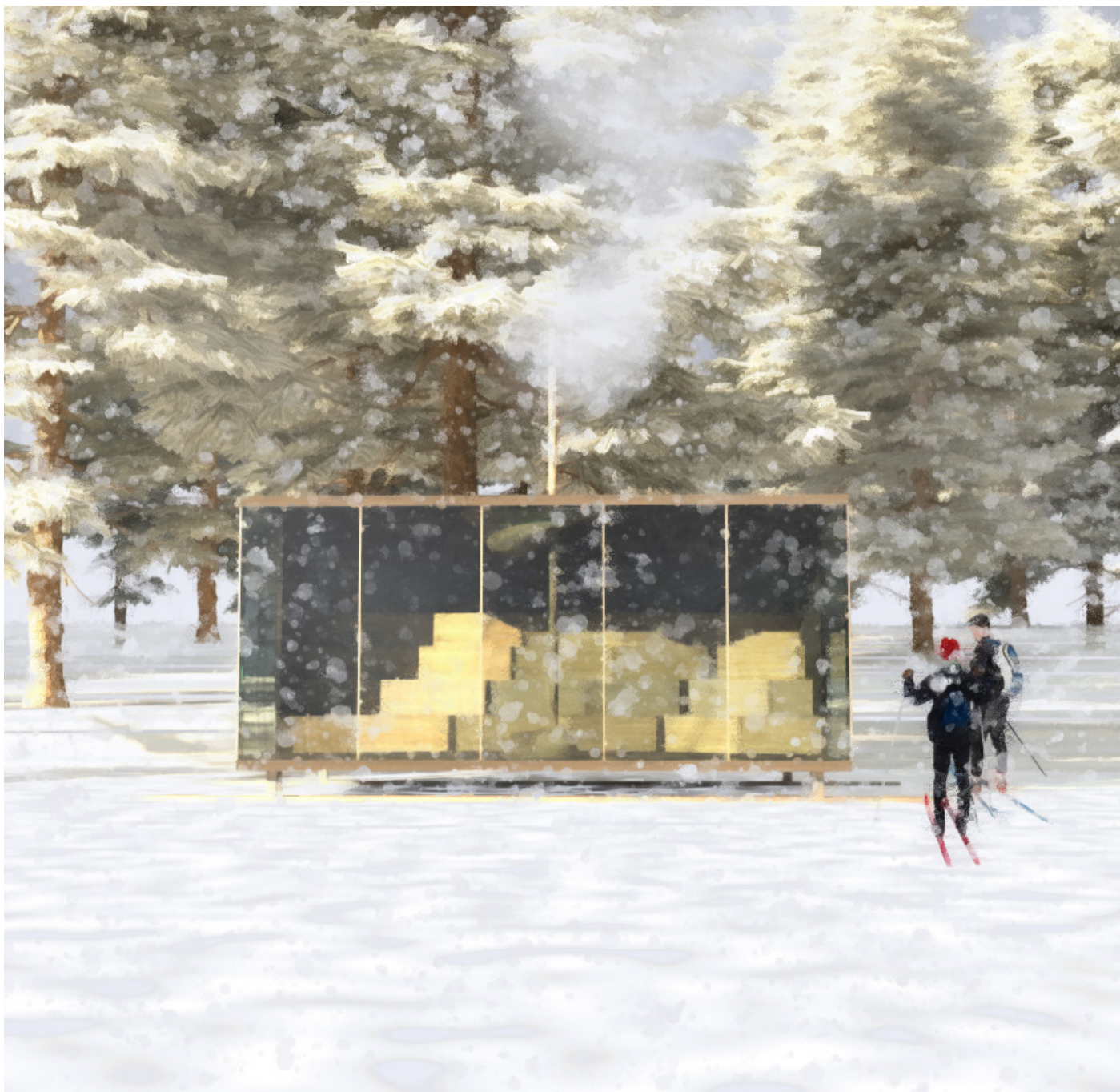

Sauna

Sauna creates cultural space for the community and serves as special aspect for the event. Its mobility derives from the context and expression from the program and location.

Mobility: on skis (due to placement in nature and around ski tracks, raised platform to counteract uneven ground)

Sauna pulls inspiration from its placement in both the event area and historic area. It combines the rational size and scale of the event structures with the historic mine of Falun by creating a seating that *resembles a mine and a stove and water retain that resemble a pile of copper.*

During event: famous Mödarbacke at Lugnet ski centre

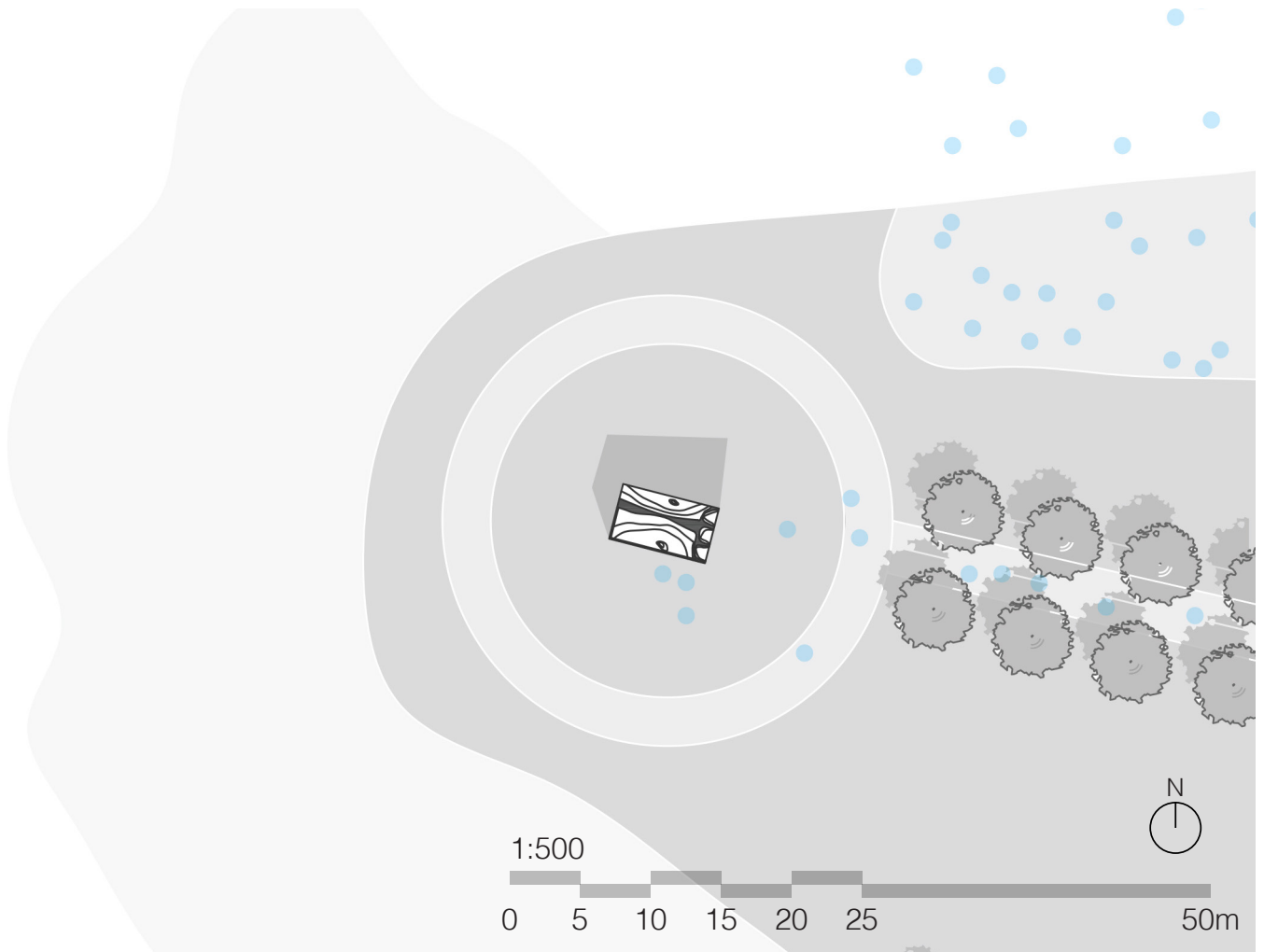
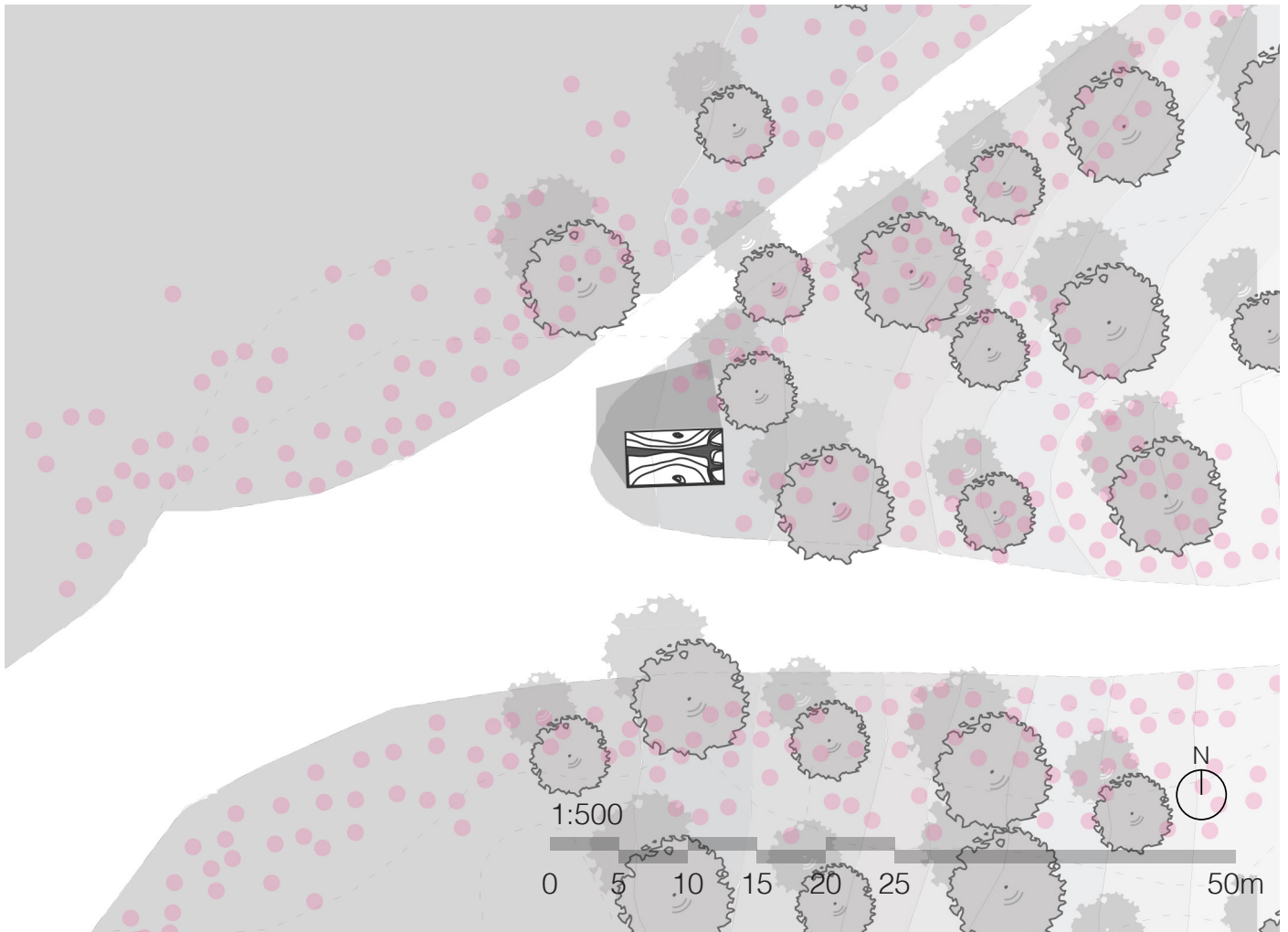

After event: lakeside park north of city centre

During event: used to warm up or as a sauna to create a special viewing atmosphere by the ski tracks. All seating towards a glass wall.

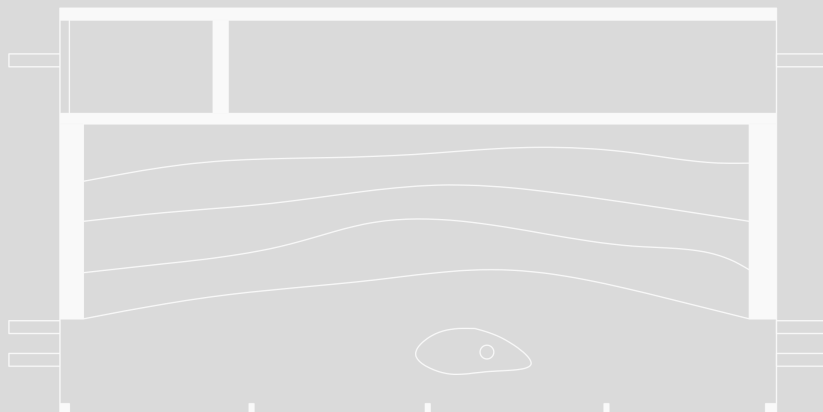
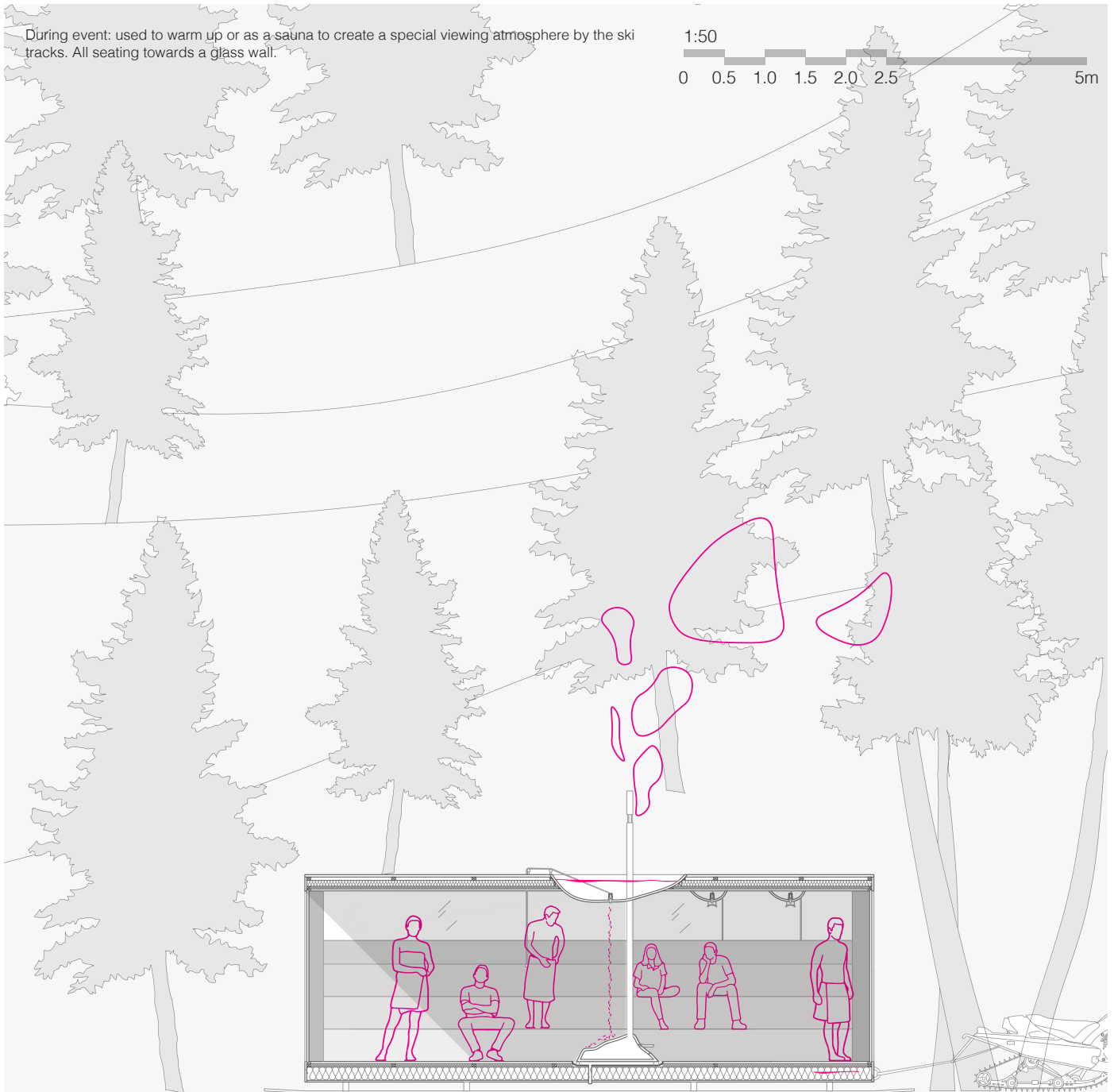
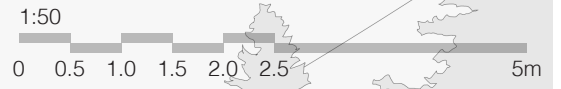

After event: used as a covered social space to frame a view or kota space to support the existing strong outdoor lifestyle in Falun

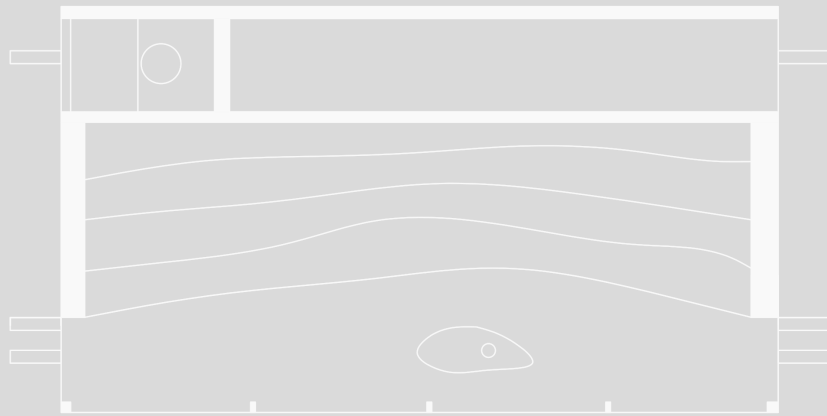
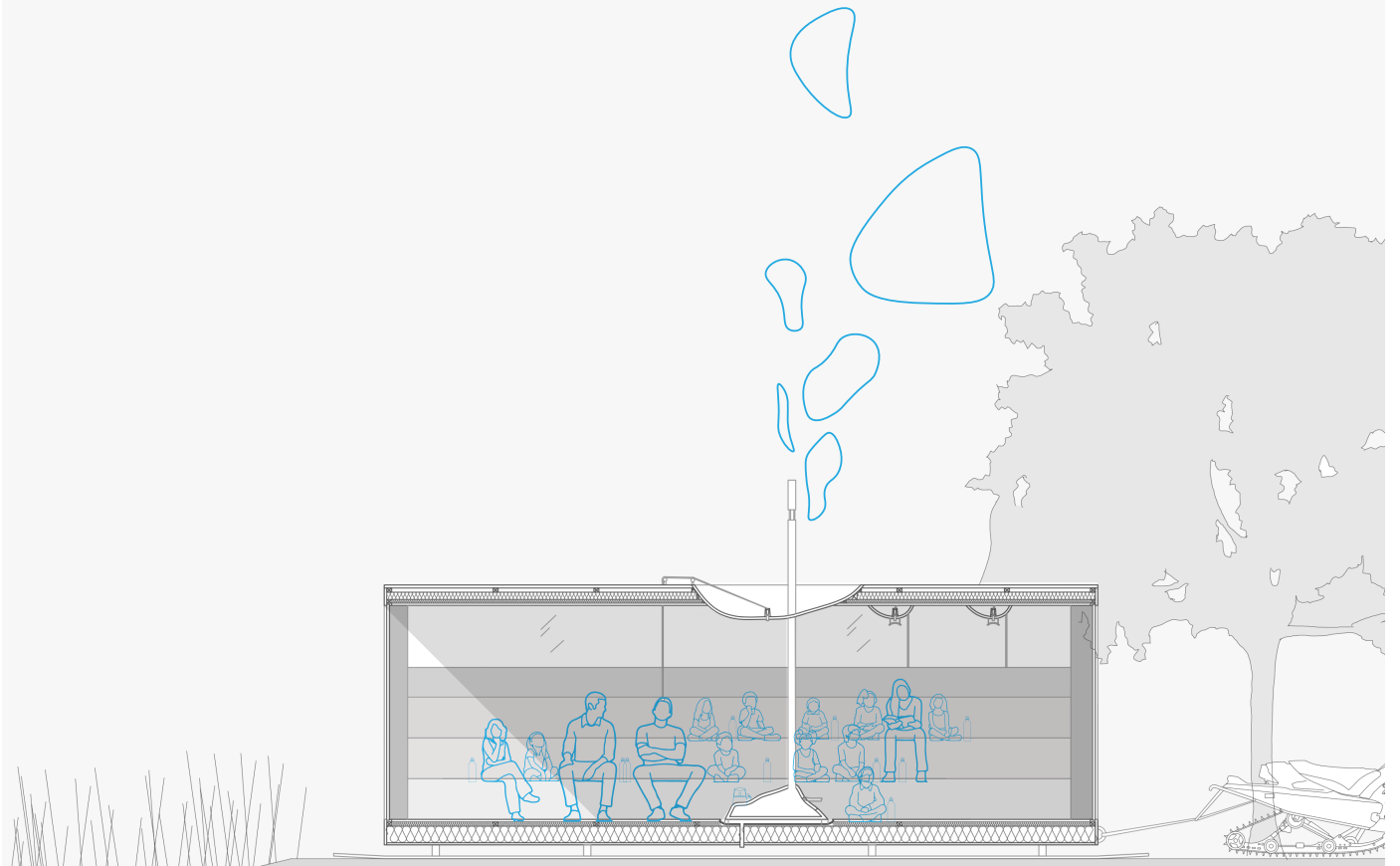
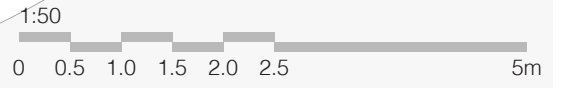

Detail of the floor and roof with connections to water reattainment and stove.

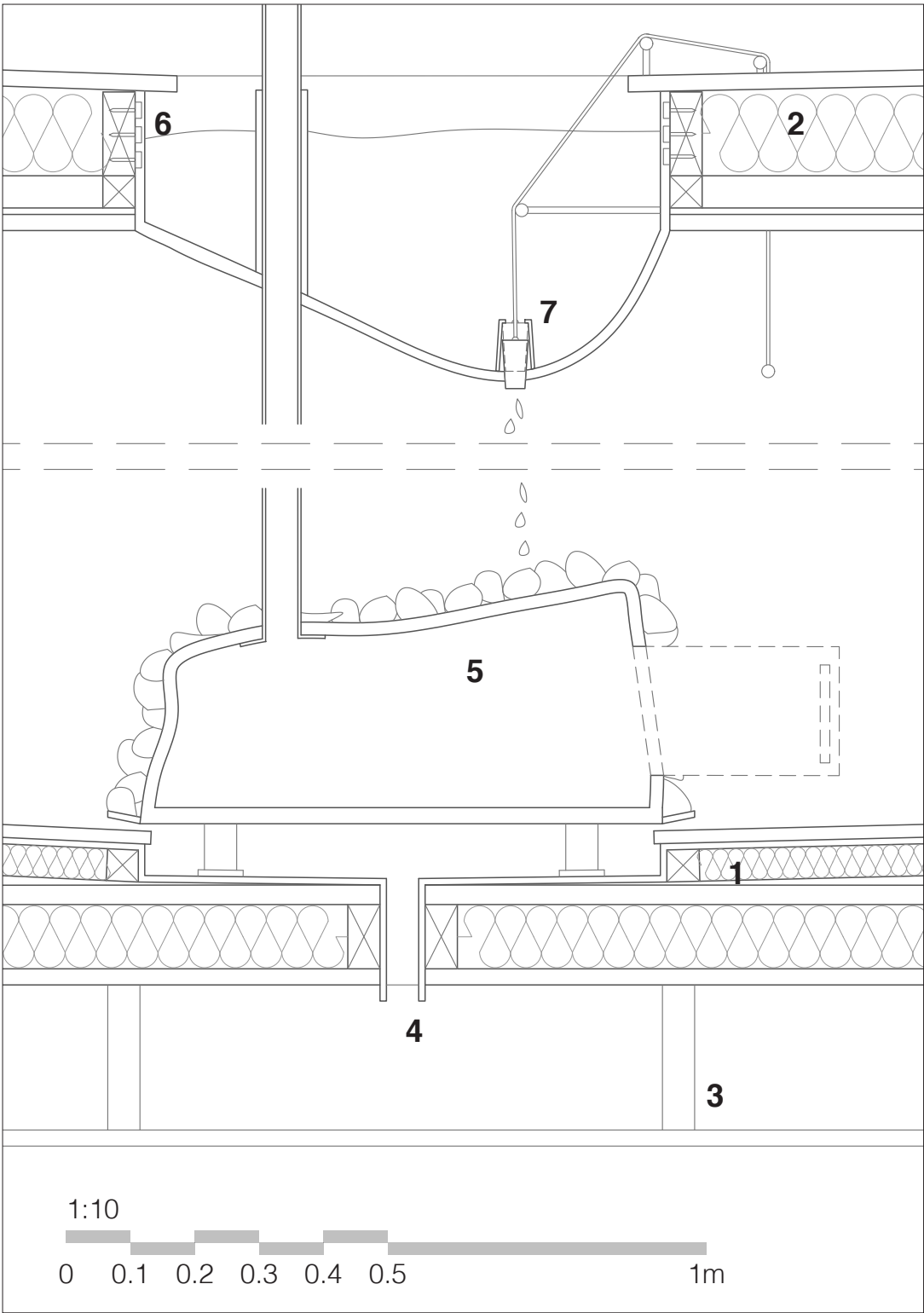

- 1 Lightweight, waterproofed and tilted raised floor with wood finish
- 2 Lightweight roof with tilted sheet metal finish
- 3 Metal connection from floor to plastic skirts as mobility aspect
- 4 Drip drain for water and condensation
- 5 Conventional wood fire sauna stove that is covered with sauna stone
- 6 Metal "bucket" that collects rainwater from the roof to be used in the showers and on the sauna stove
- 7 Water release for the stove that functions using a pulley and gravity





Stand

Stand provides commercial space for the event and flexible office, commercial and other use for the community. Its mobility is based on urban qualities and expression layers its surroundings.

Mobility: accordion due to changing uses and spatial needs, on wheels to make easier for user to control

Stand pulls inspiration from its placement in both the event area and urban area. It combines the rational size and scale of the event structures with urban shapes and colours to create a *layered motif of façades* that can be pulled open to create a larger space when needed.

During event: walkway to entrance of Lugnet ski stadium

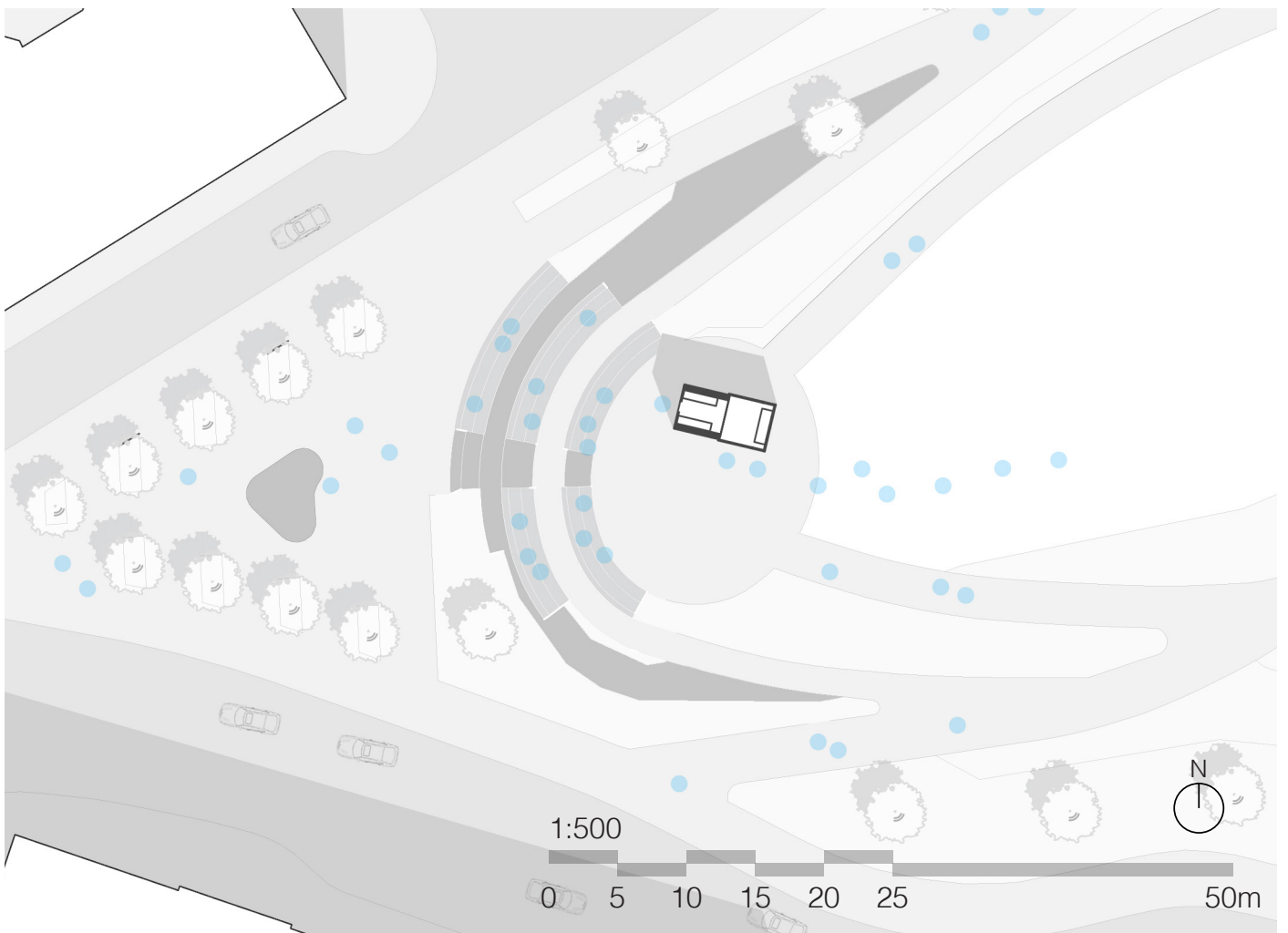

After event: new city square close to railway station

During event: used as a commentary box by open only the climate controlled areas to create a small cabin with large windows to follow the competition.

1:50
0 0.5 1.0 1.5 2.0 2.5 5m

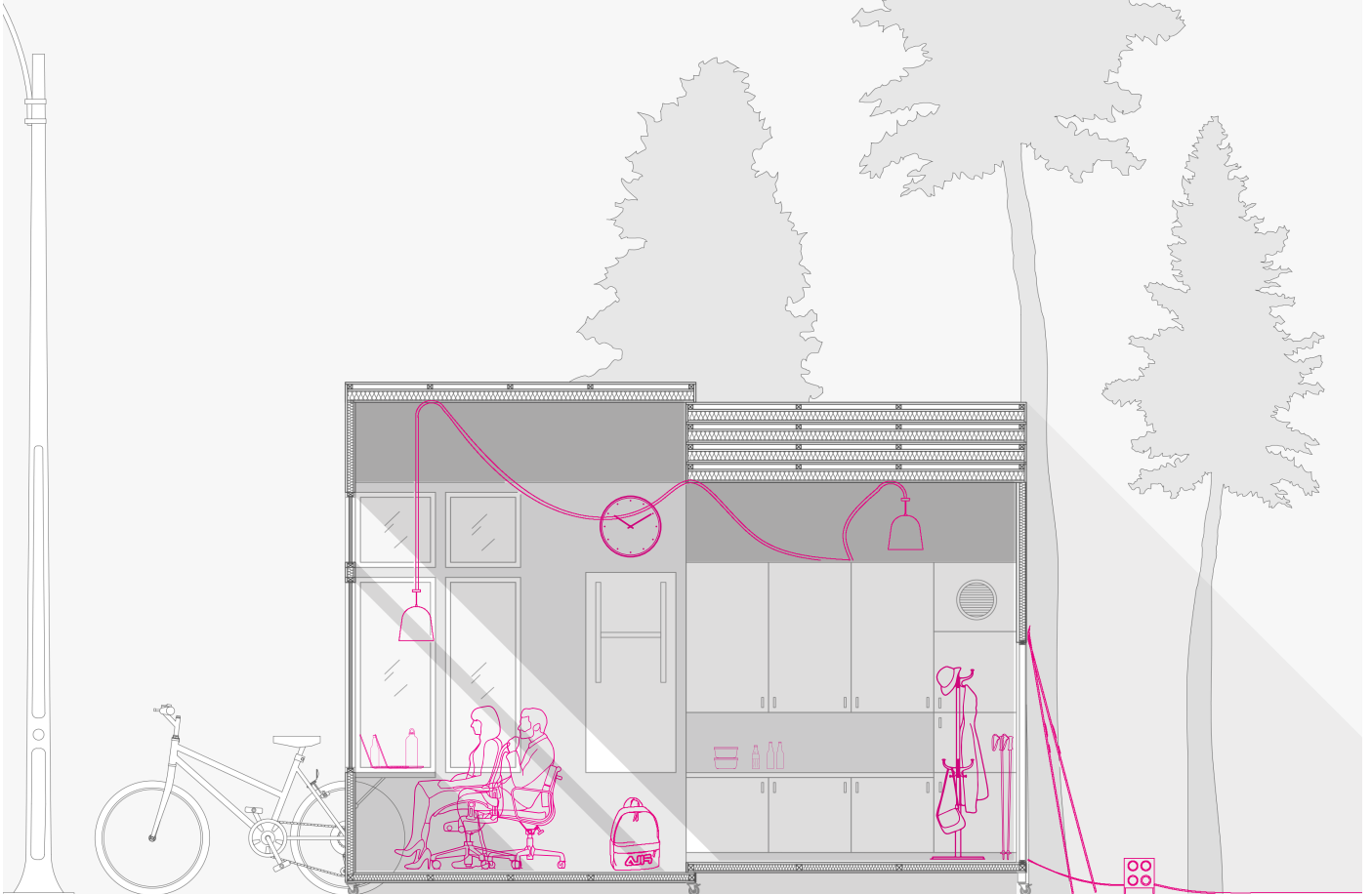

After event: used for example as a pop up cafe during the summer months in the park by opening the whole length to create covered space

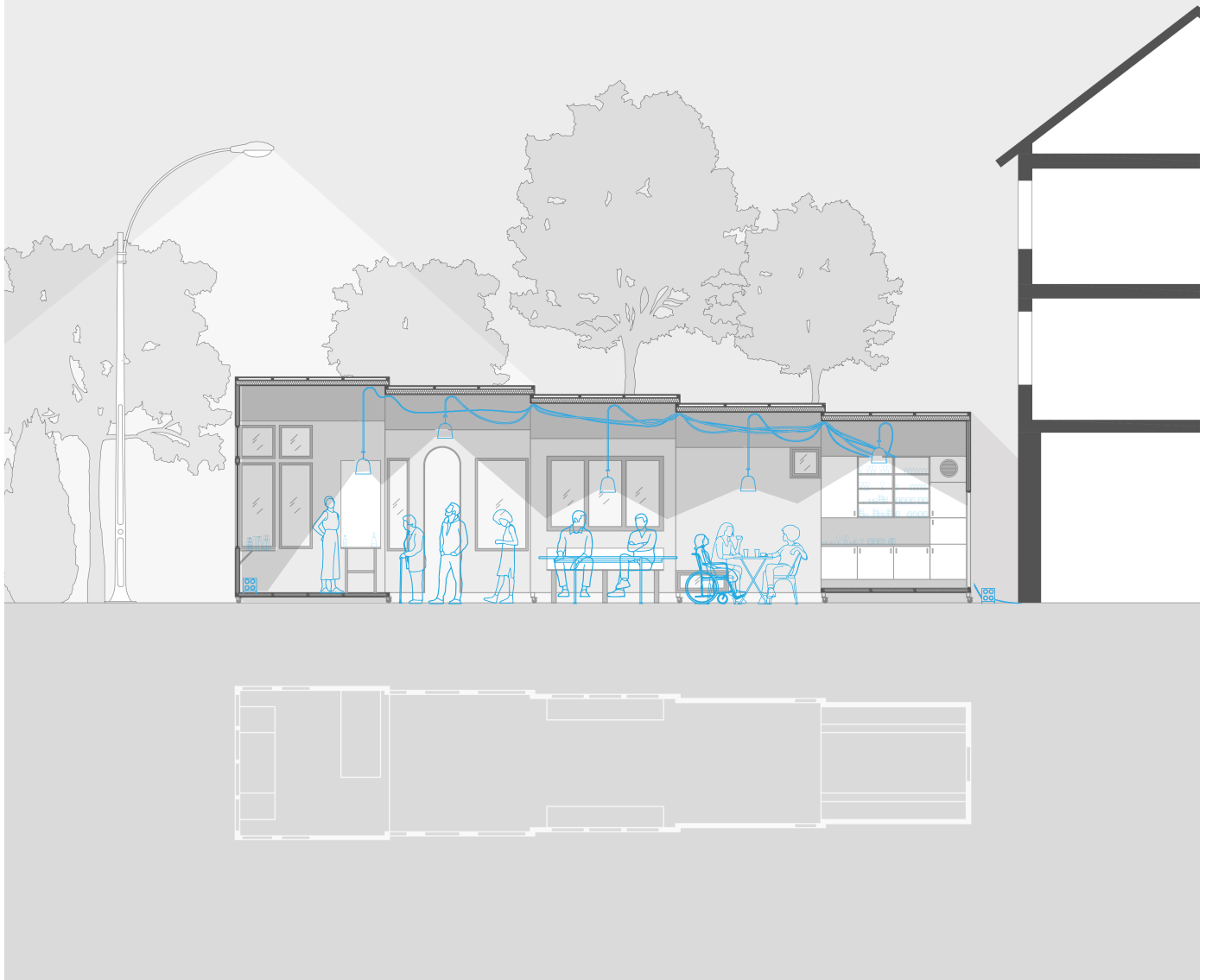
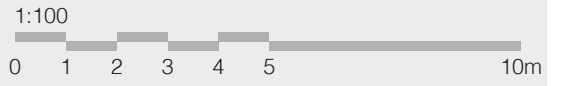

Detail of the connection and movement of each section of the structure

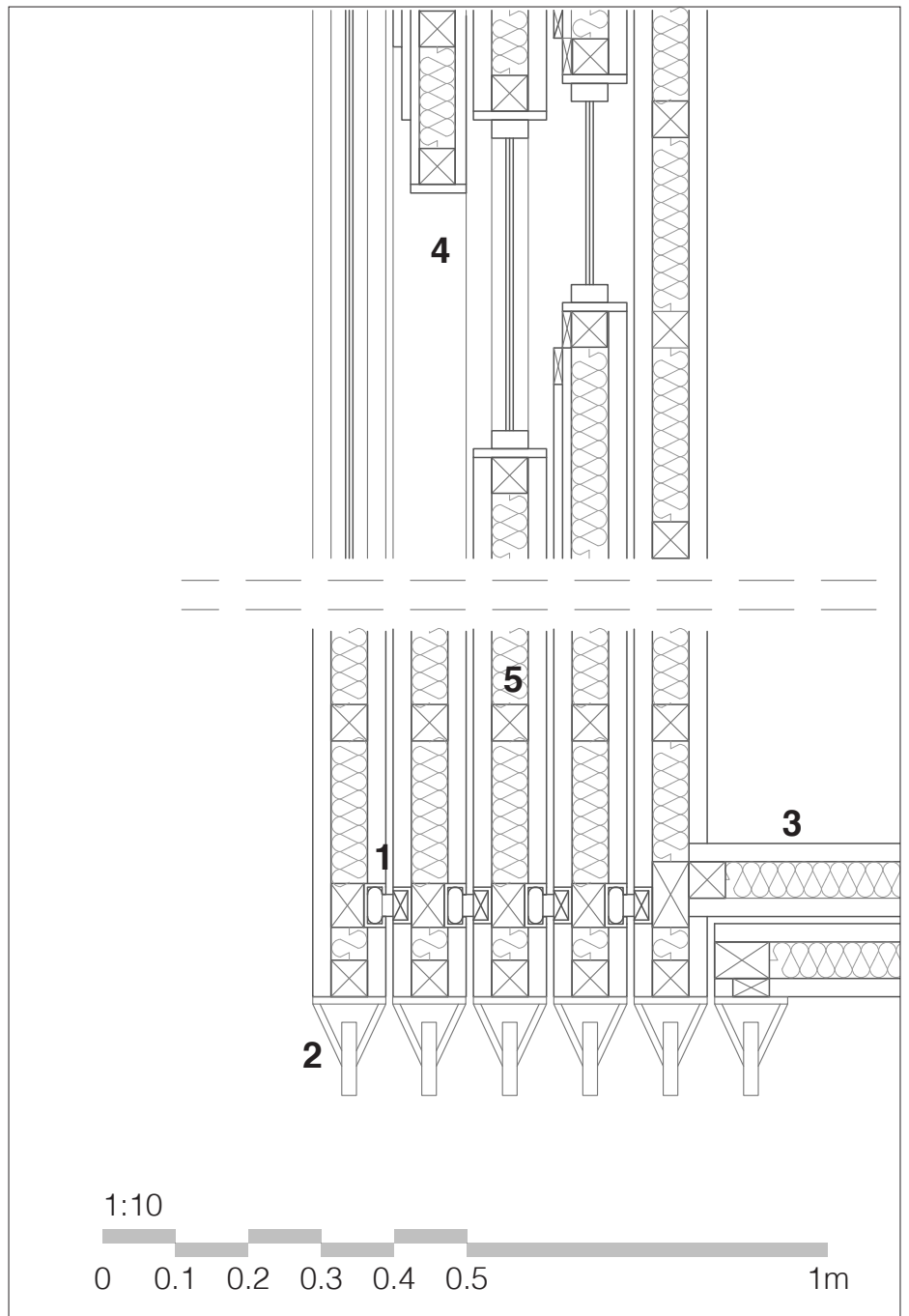

- 1 Large scale metal and rubber runner to open and close structure
- 2 Small scale simple wheels on each end of each section
- 3 Lightweight metal frame flooring at the end sections
- 4 Overlay of different openings on different sections
- 5 Lightweight metal frame lightly insulated wall structure with wood finish





Pavilion

Pavilion provides open but guided space for the event and flexible organized space for multitude of uses. Its mobility is based on changing needs and expression pulls from Faluns history.

Mobility: flat packed due to ease of storage and collection for user, able to select how many needed from a pile stock

Pavilion pulls inspiration from its placement in both event area and history of Falun. It combines the event framing into an exposed wall structure that is covered with a textile that has been painted with *Dalmålningar* to create a wall that can be opened or closed and lengthened based on needs.

During event: city centre park

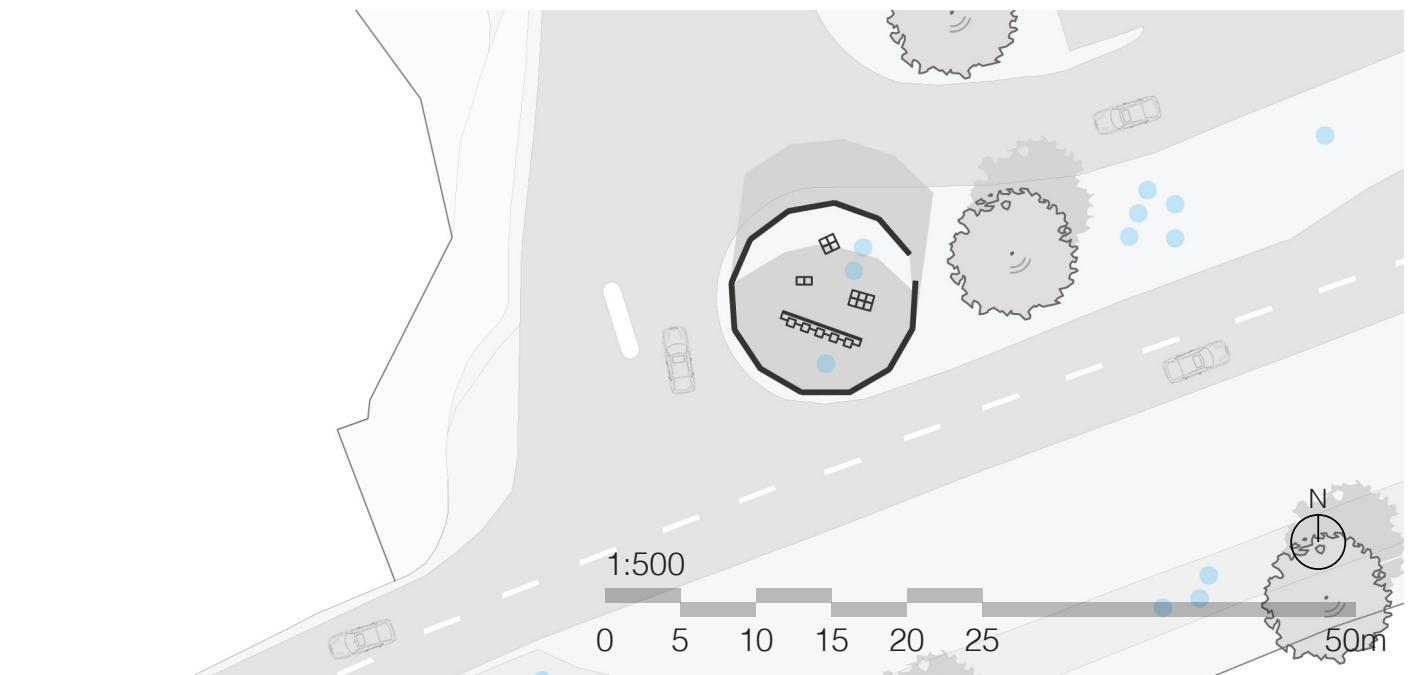
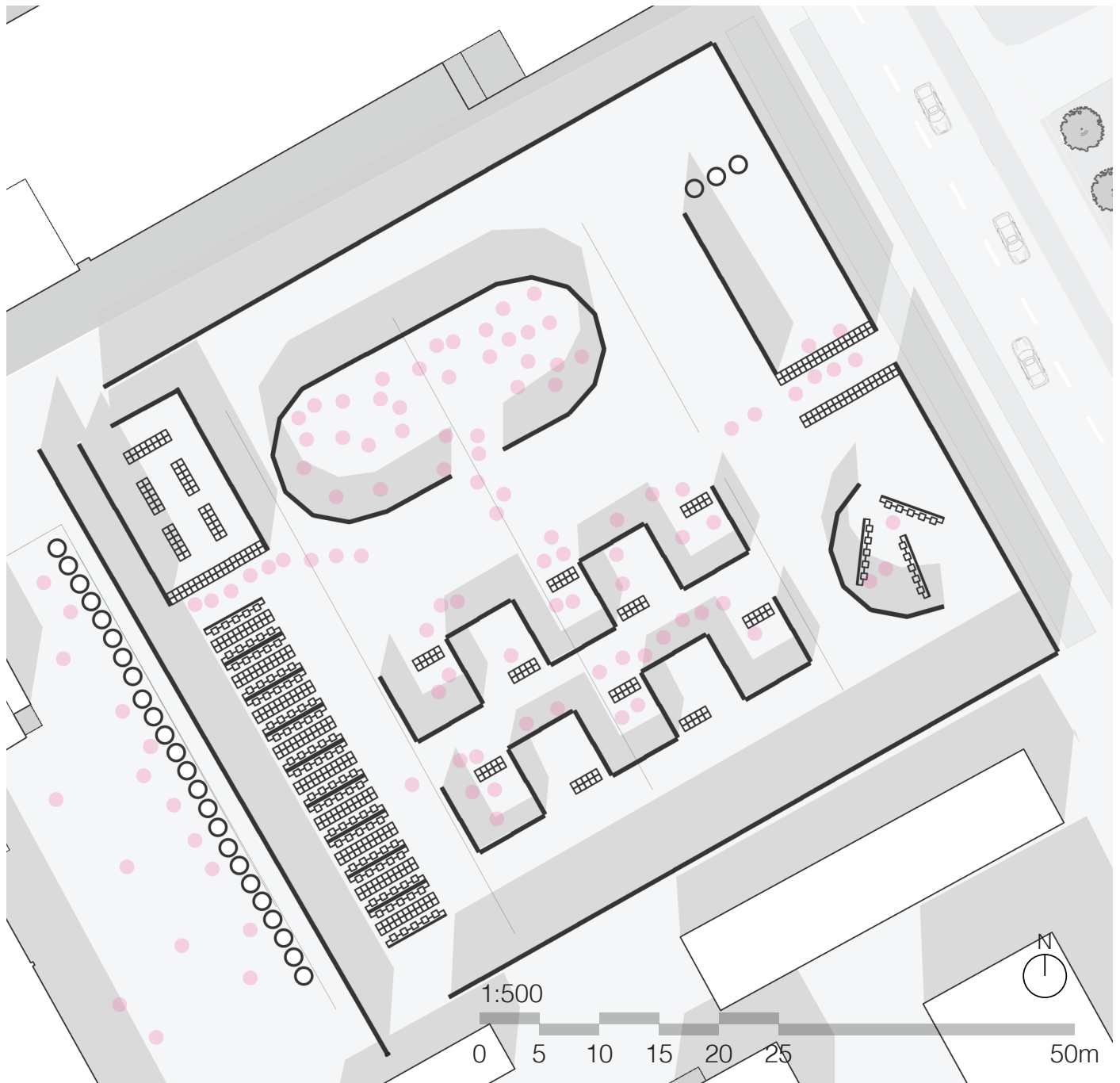

After event: lakeside walk south of city centre

During event: used as a audience space where food and beverages can be served, curtains opens to provide views to the competition yet separating the audience from the competitors.

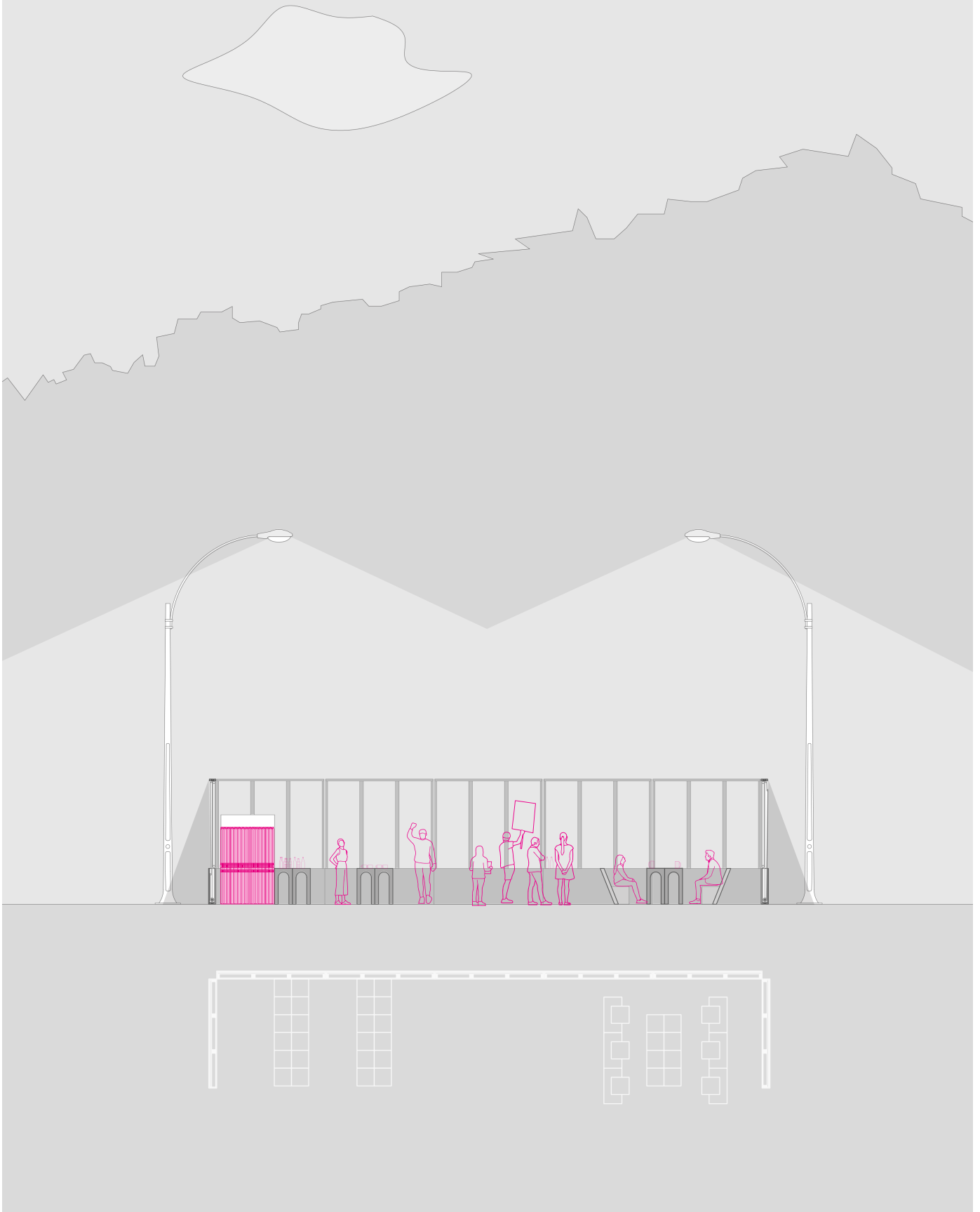

After event: used for example as a exhibition space for a local artist to provide accessible free space to showcase their work. Curtains closed to create a framing for art.

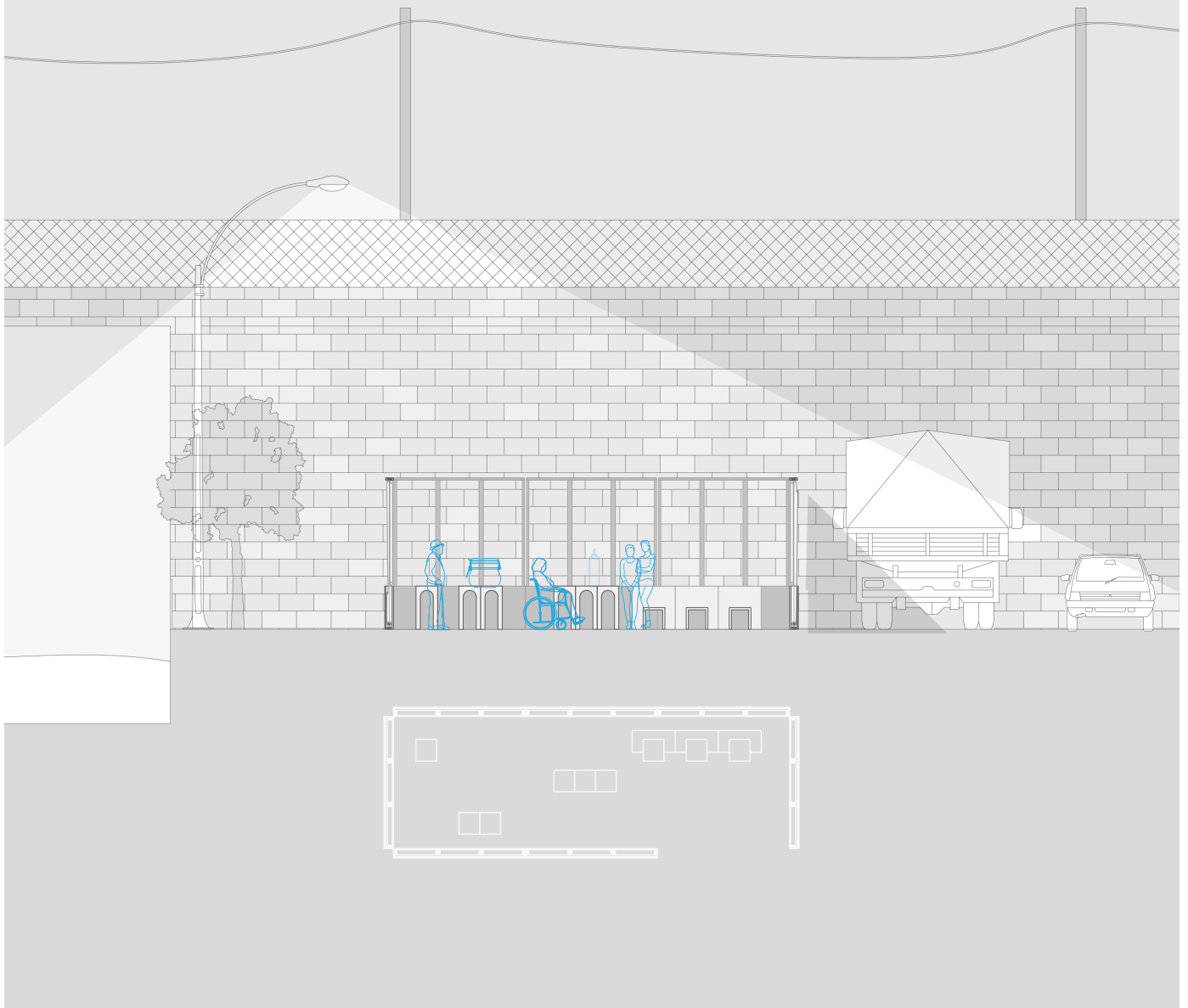

Detail of the connection to ground and curtain function

- 1 Wood wall with sheet metal finish
- 2 Metal poles to used a footing to secure structure in place
- 3 Roller for curtain inside wall structure
- 4 Rope pulley system built in small roof cover
- 5 Winch to open and close curtain

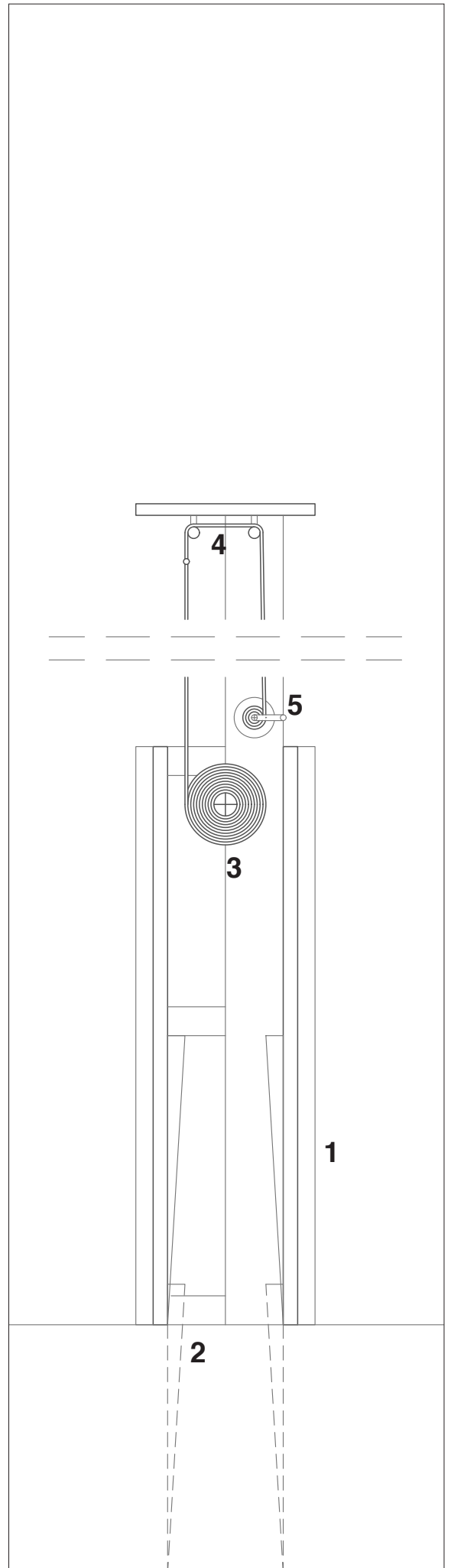

1:10







Maja

Maja provides housing for the event and support other events and housing needs on the area. Its mobility is based on easy of transport and expression plays on the idea of blending in.

Mobility: on wheelbase for ease of setting up and moving to location to respond to needs

Maja pulls inspiration from its placement in both the event area and urban area. It combines the rational size and scale of the event structures with *urban stone scale wall which is made out of wood* to create a lightweight movable room.

During event: empty parking lot, sand field close to event location

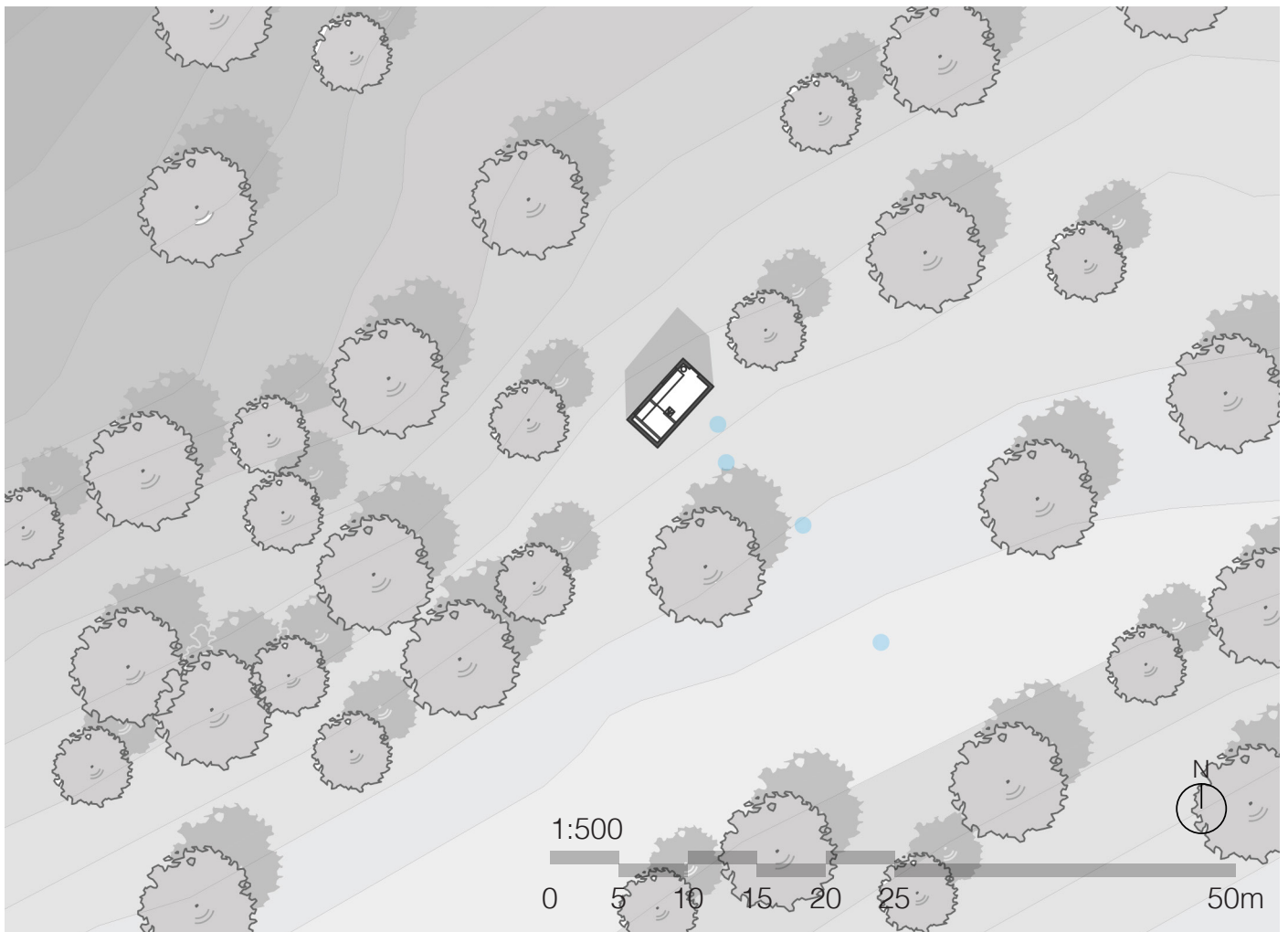

After event: nature reserve east of city

During event: used as a ski-wax cabin to support competitors with limited resources

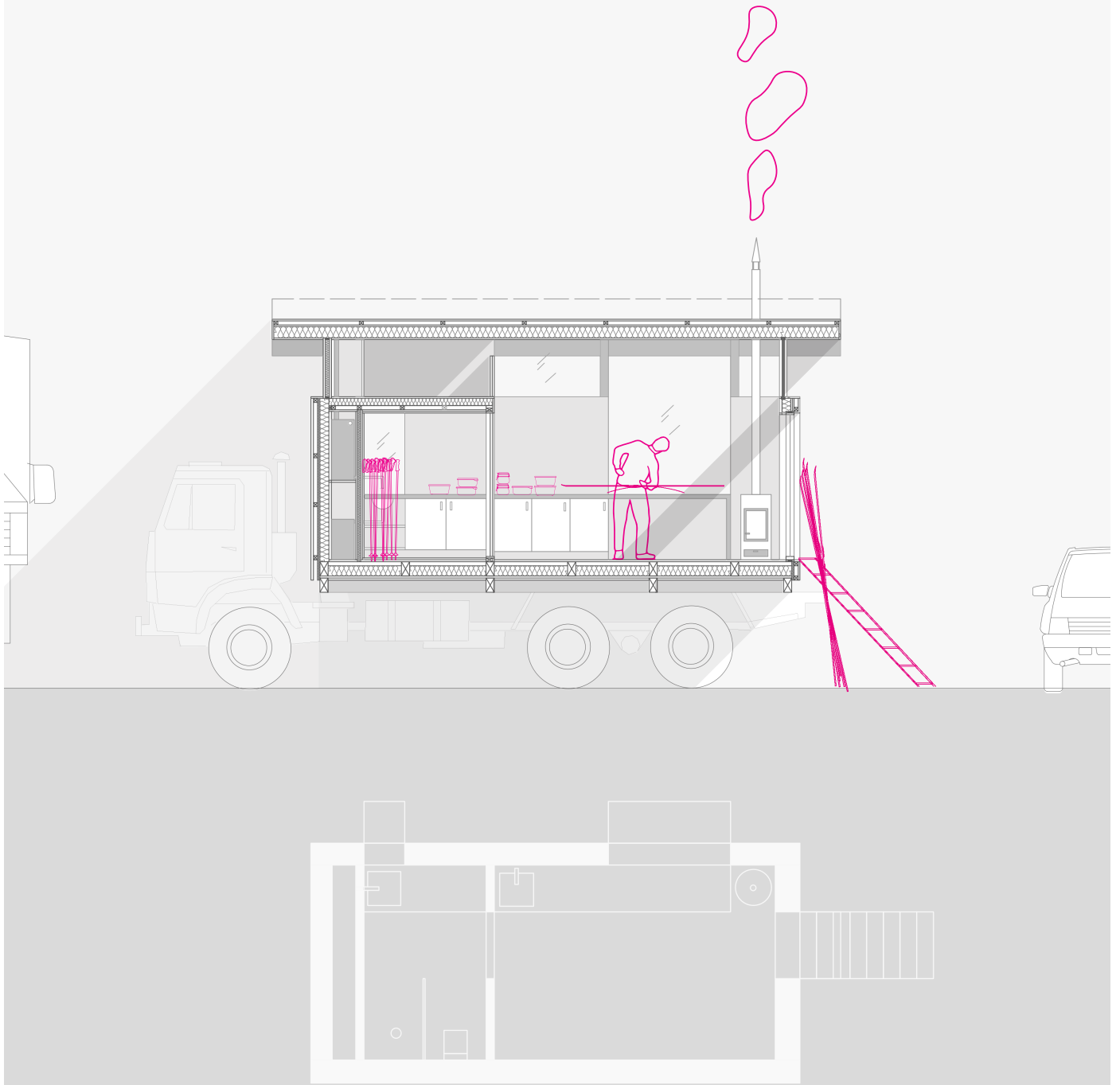
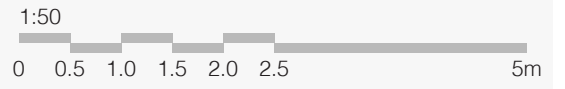

After event: used for example as a remote hotel room in the nature reserve

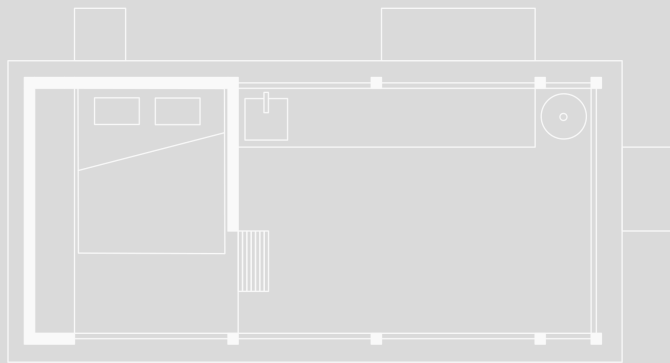
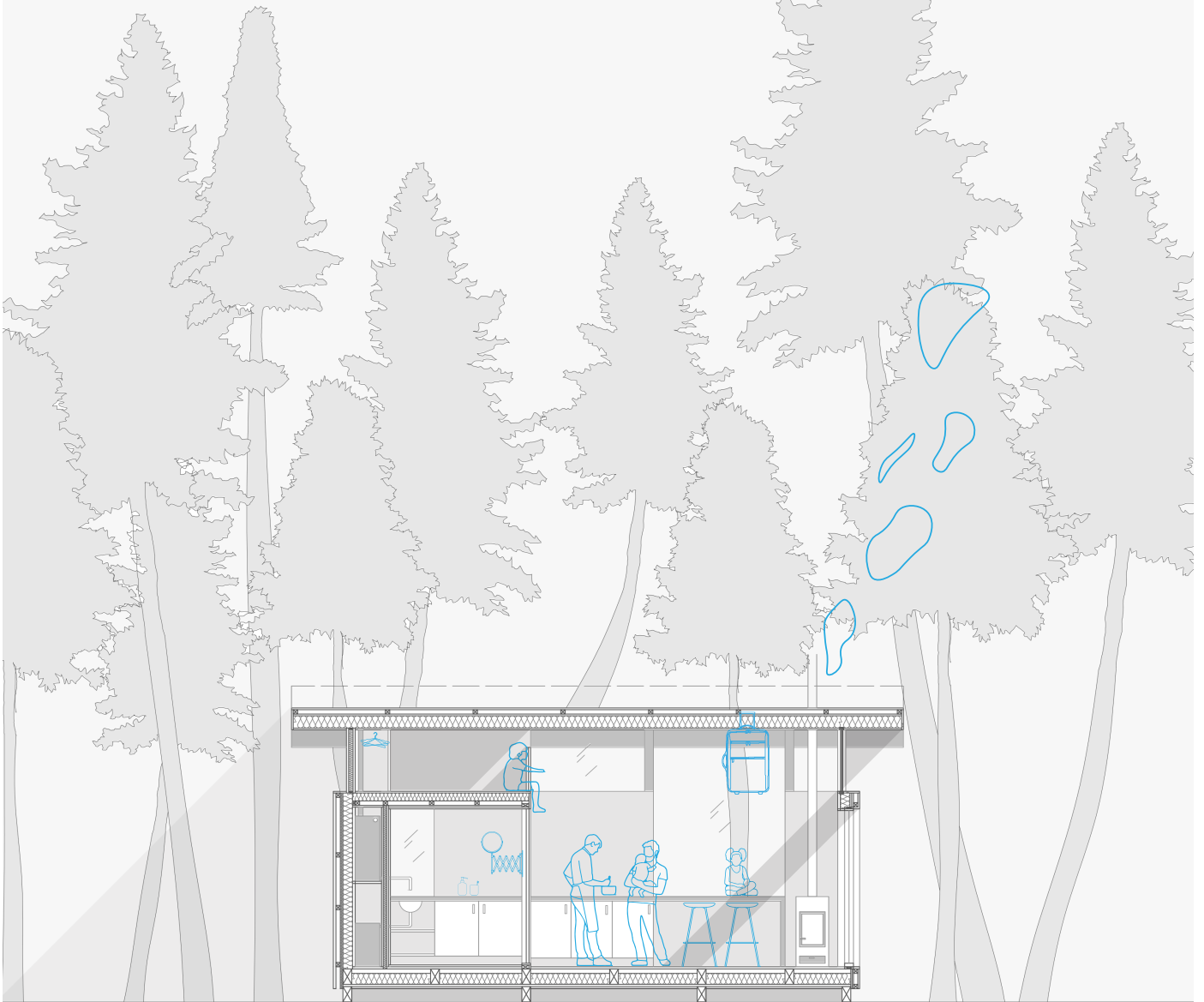
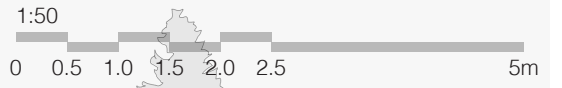

Detail of the floor and wall structure

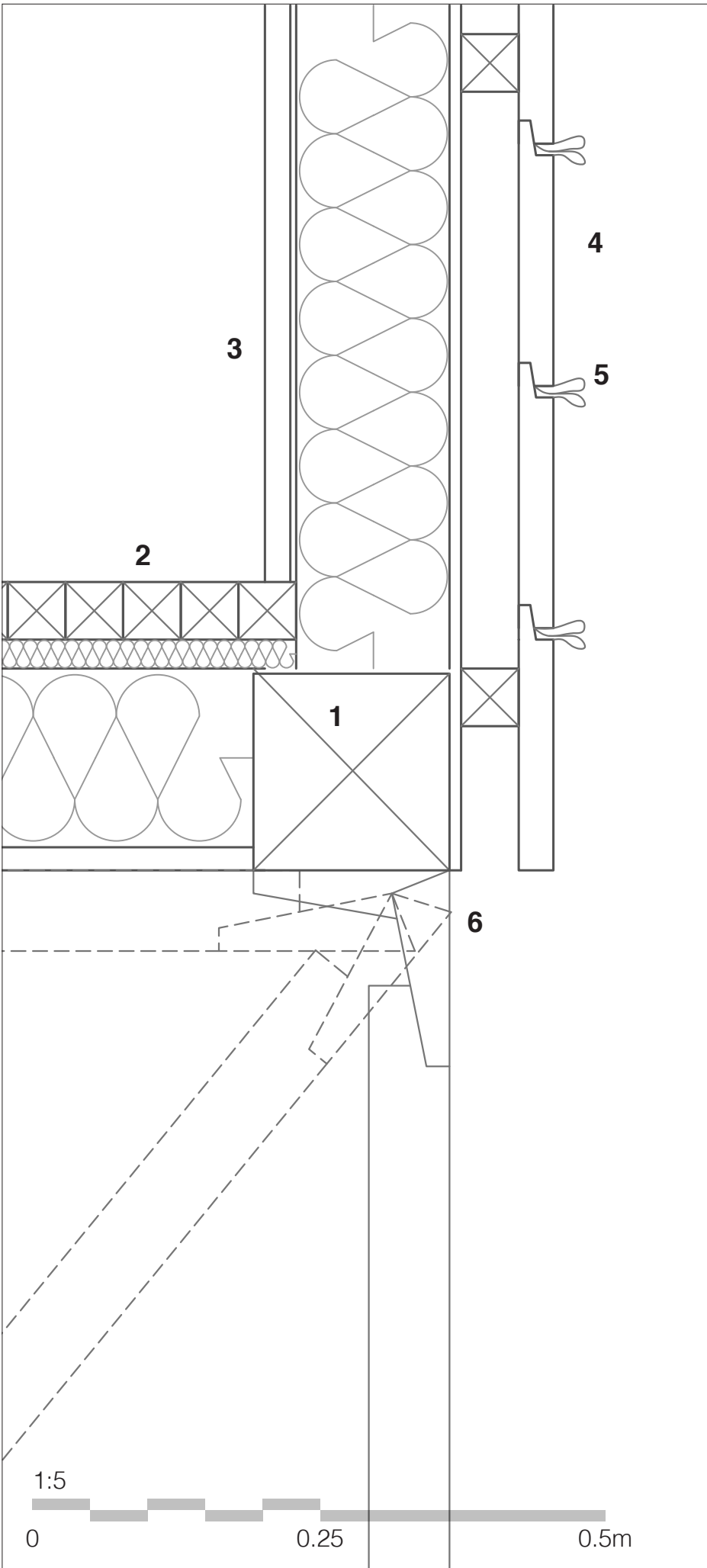

- 1 Timber structure
- 2 End grain timber floor for durability
- 3 Birch ply wood finish
- 4 Wide Birch plank facade
- 5 Birch bark as a traditional touch
- 6 Swinging telescopic leg to mount the structure in different settings





Stage

Stage provides celebration space for the event and cultural access for the community. Its mobility is more permanent and expression pulls on the programs history.

Mobility: on stilts for stability and more permanent feeling to create symbolism, yet able to be moved to event needs

Stage pulls inspiration from its placement in both urban area and use during the formal event. It combines the *historic identifiable details into a representation of the details found in the existing theatre's structure*. The aim is to create smaller stages that function independently but are collected into a larger stage when needed

During event: Stora torget, city centre

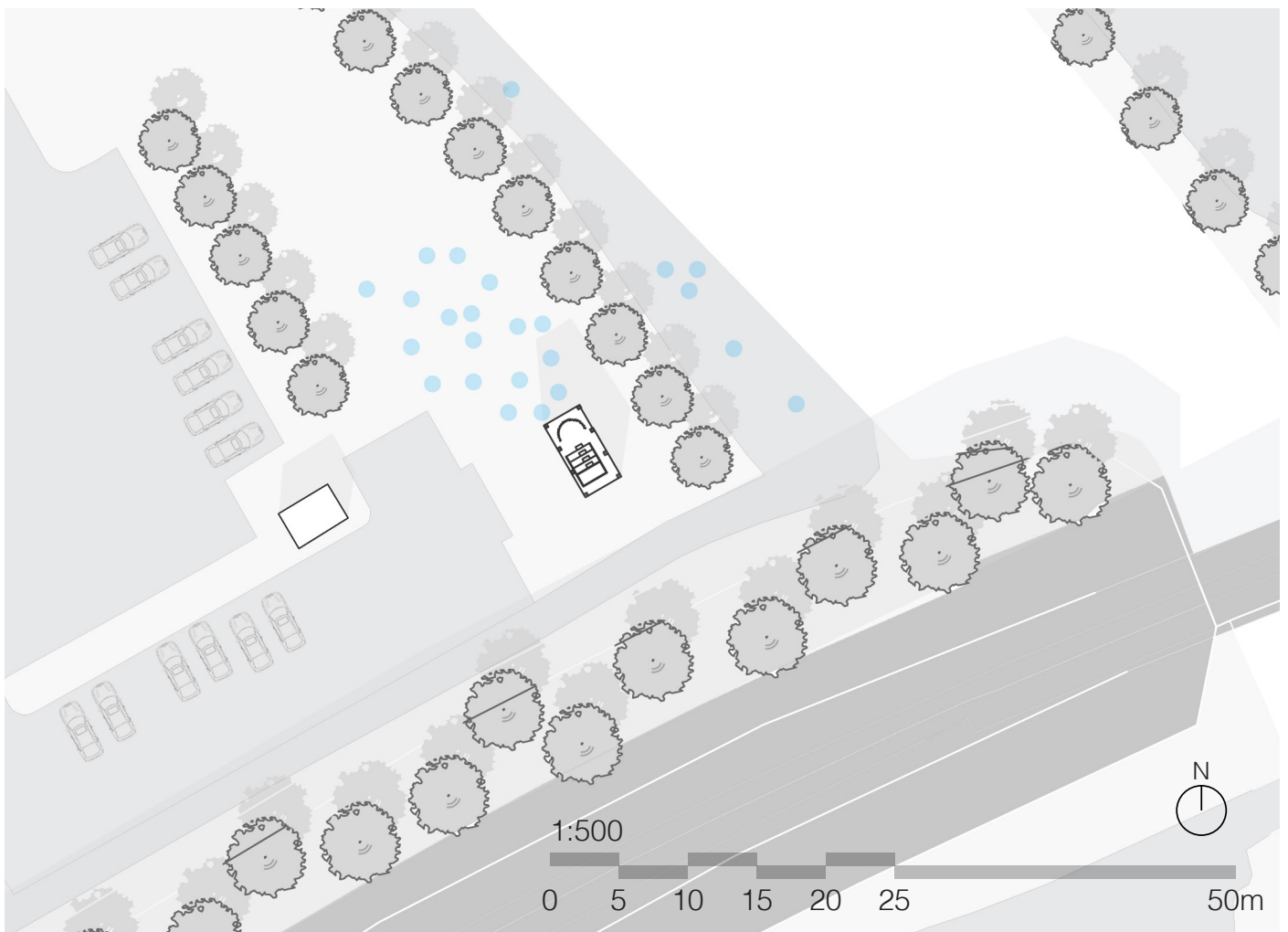
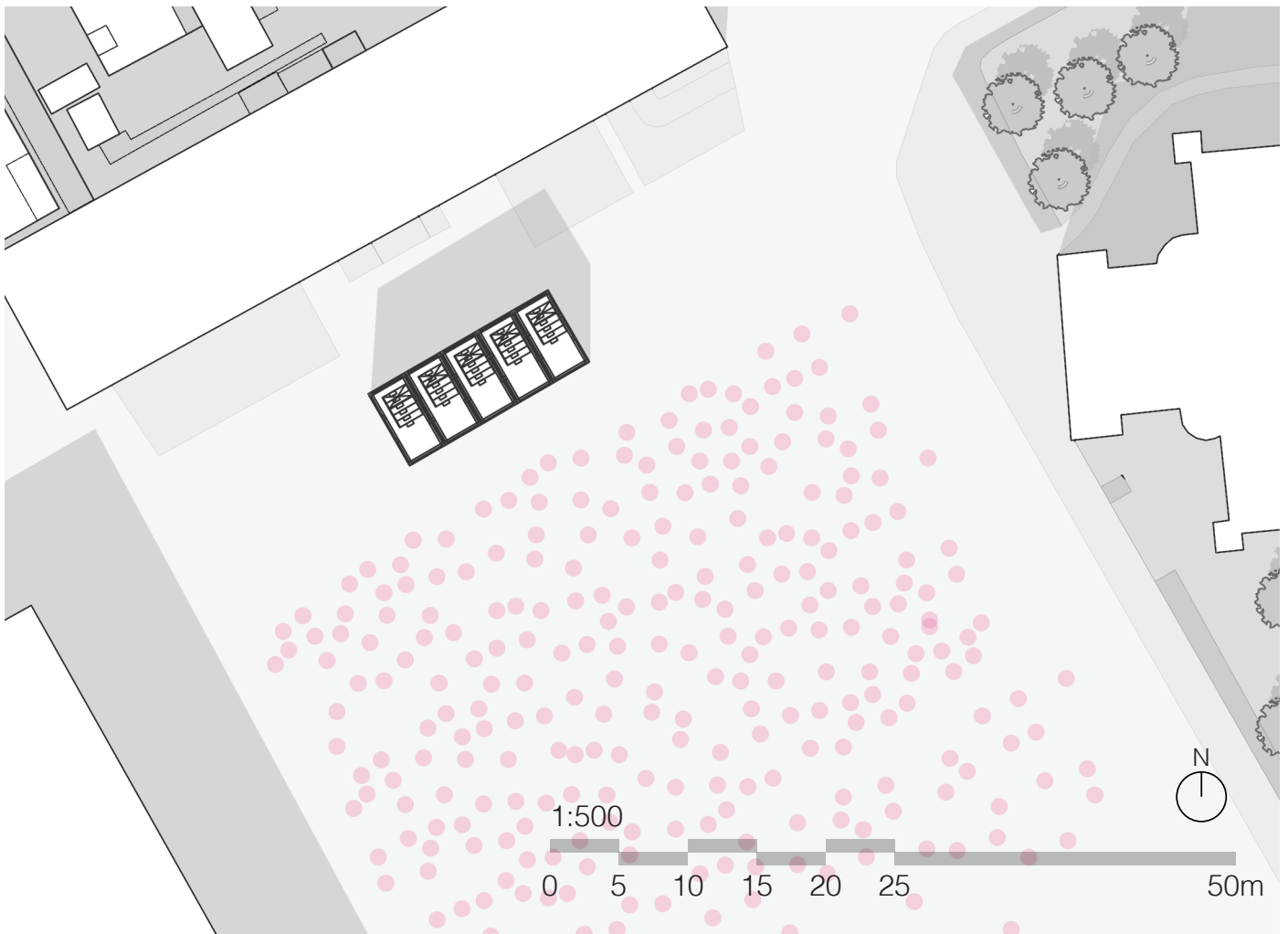

After event: park next to river and formal theatre

During event: used as a larger stage to present medals to the winners and stage for musical performances.

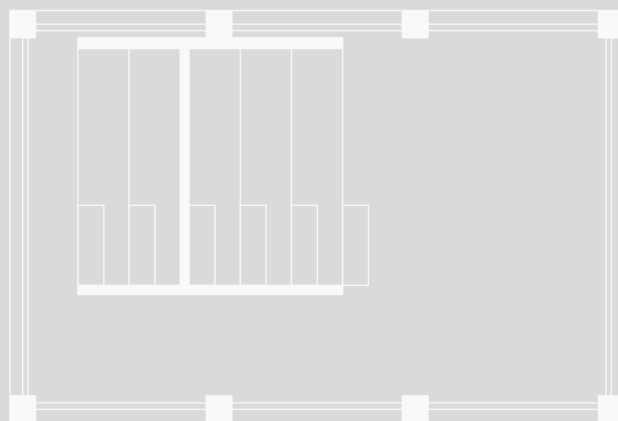
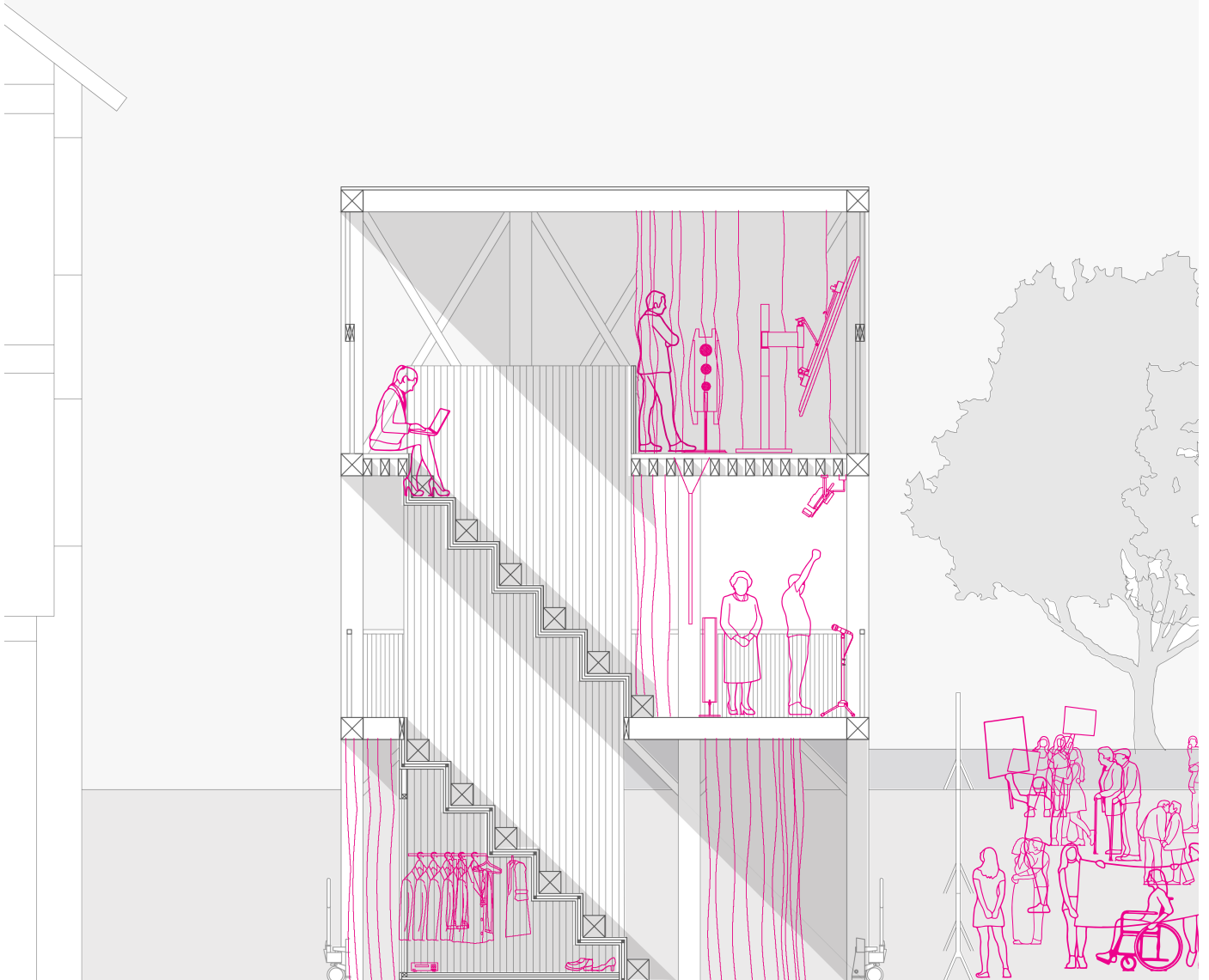
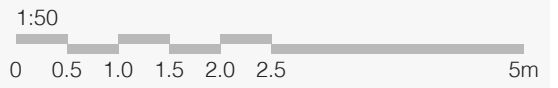

After event: used for example as a tiny community theatre space

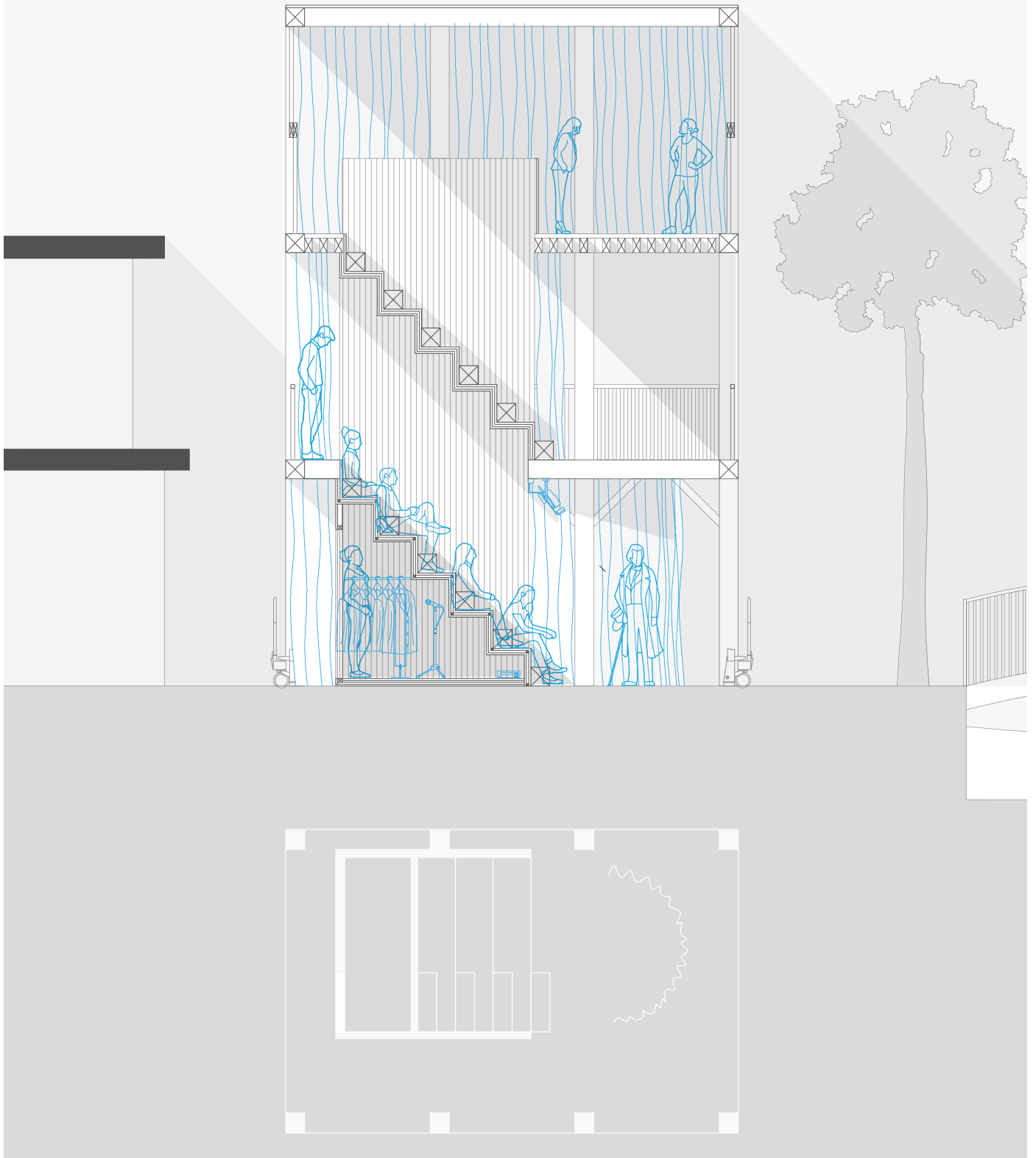
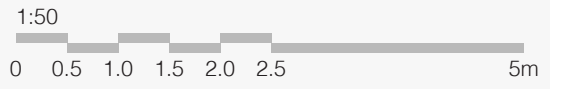

Connections of the timber structure are made without using glue or metal screws by using more traditional timber building techniques to strengthen historic expression and ease of disassemble

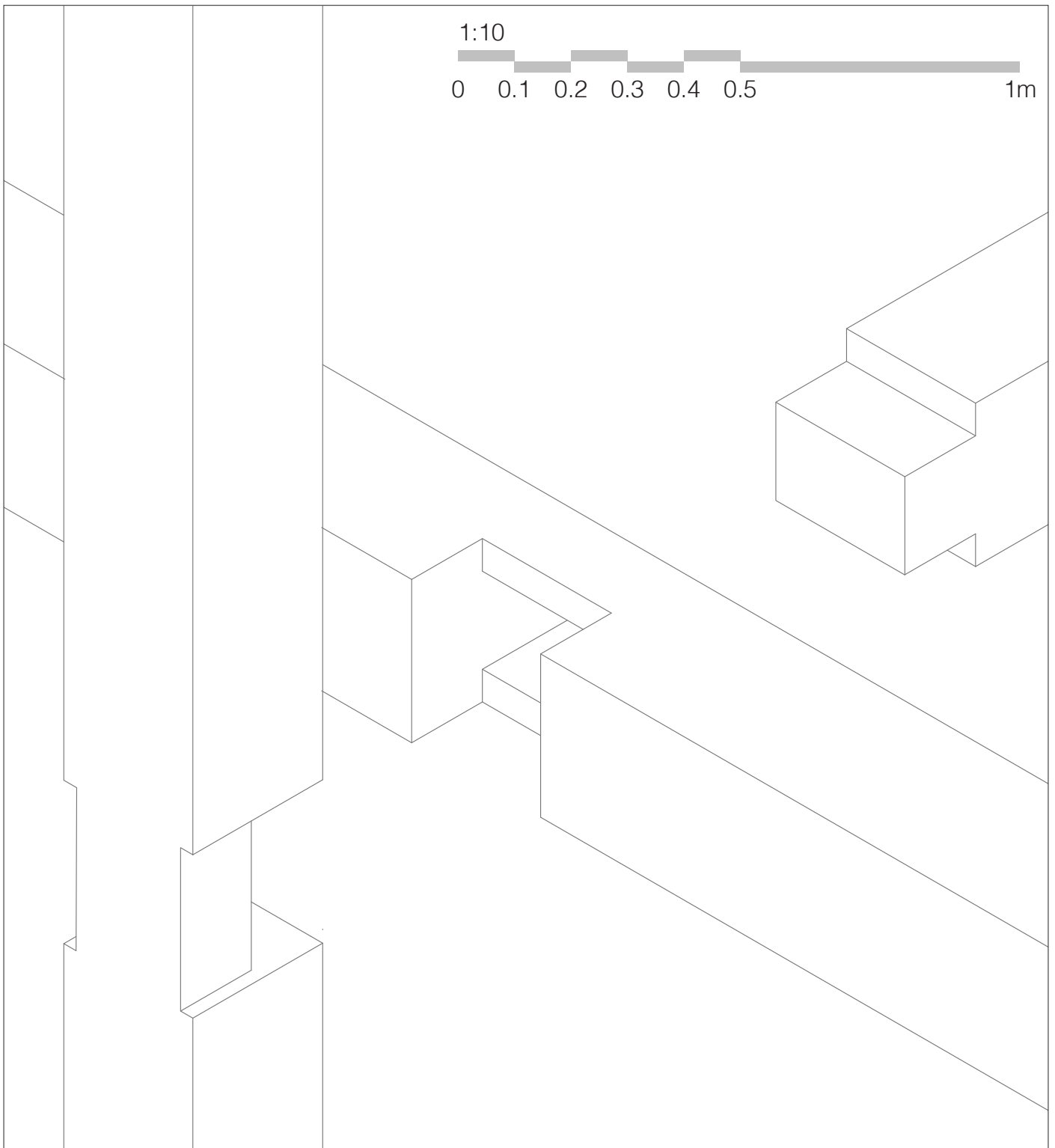



Discussion

Whilst the project touches on the large scale implication temporary structures have in regards to events in general the project had a large focus on the case study and the design of the case study to illustrate and test how the event can have a long term beneficial impact for the community and how local peculiarities can be brought to the architectural form.

Whilst the focus on a case study was good in terms of being able to illustrate the concept in practice it should be noted that every location has a different community that might have differing opinions on the subject. It should also be mentioned that the project leaves out commercial and political decision in large part on purpose, although they did function as a base for what the buildings should be geared towards.

The main role I see temporary structures to have in event creation lays in the definition set in the beginning of the project. Temporary in terms use, not in material use. Combining uses together in different structures creates spaces that both sides need, the event and the community. The design is more flexible and for a long term plan the design should cover a multitude of different programs to become useful for the individuals but not too universal to fall into the trap of designing for everybody and nobody at the same time. This was done by creating multitude of structures that can be interpreted for different uses yet have built in suggestions for use such as the stand that can be used for indoor, outdoor, private and public function yet it has a sense of place in Falun and with its size and inbuilt furniture guides the user.

This once again illustrates to benefits of temporary structures, they are malleable to the environmental, social and spatial needs where as permanent methods limit or slow the progression.

The question surrounding flexibility was a constant through the project and thus many of the projects aspects became suggestions rather than solutions. Flexibility in the project manifests itself through the structures physical appearance when the structures program changes,

for example the pavilion only guides the used area of space. Flexibility was also looked at a larger scale in terms of it creating harmony between the event and its context through movement. The illustrated locations have been determined to be feasible and suitable for each structure yet it would be interesting to see where the community decided to place the structures without the designers involvement.

Implementing local qualities into the new designs proved to be a more difficult task. The technical limitations and programmatic needs limited the liberties one could have taken in the design phase, such as doing a high chimney or a heavy wall. Whilst the creation of local typologies was useful to identify the structures contextual identity it would have benefited from a longer study into the social aspect of Falun to take the structures further.

The intention was not to replicate mini versions of the surrounding rather use them to inform the new structures. By creating a tool kit of the local colour and material palette, considering the history and identity of the place creative ways of alluding to the surrounding context can be created like the stages structure and colouring but a further study into the experience of the user would be interesting although it might prove difficult when trying to combine programs and create flexibility.

For the community itself the more important part might be the question of ownership itself. By introducing flexibility and openness for the local to interpret, use and test the structures without the private owners or the designer being involved arguable will be a more valuable yet the question of will the structures be used or will they be turned permanent and how their maintenance of the structures is organised remains and would be an interesting topic were the project taken further.

It would also be interesting to run a similar case study in multiple locations that have differing situations such as Oberstdorf that has existing structures for the event but due to

climate change might not be able to host the events anymore or a completely new scenario where more infrastructural and larger building processes are needed to understand what form flexibility and temporary takes in these contexts.



List of illustrations

Image 1. Falun critical snow conditions

<https://twitter.com/FISCrossCountry/status/748407929800364032>

image 2. Jim Stephenson Paleys upon pilers <https://www.studioweave.com/projects/paleys-upon-pilers/>

Image 3. Jonas Lindstedt Svettekyrkan Bastu 2022

<https://www.gp.se/nyheter/göteborg/klart-svettekörka-ska-byggas-upp-igen-1.85621583>

4. Laboy, M . Fannon, D Types of resilience <https://www.semanticscholar.org/paper/Resilience-Theory-and-Praxis%3A-a-Critical-Framework-Laboy-Fannon/0f7571349694571f55c6168c1195cb3df29e69f9>

Student background

Bachelor of Arts Architecture (honours) University of Creative Arts, United Kingdom

Chalmers University of Technology Department of Architecture, Architecture and urban space design

Transformation projects and environmental care

Reality studio

Matter space structure three

Rurban transformation

Bibliography

- Ahlnäs M (2023). "Sommarföre" väntar i Tour De Ski. Svenska Yle. <https://svenska.yle.fi/a/7-10025694>
- Bishop, P., & Williams, L. (2012). *The temporary city*. Routledge.
- Bertino, G., Fischer, T., Pühr, G., Langergraber, G., & Österreicher, D. (2019). Framework Conditions and Strategies for Pop-Up Environments in Urban Planning. *Sustainability*, 11(24), 7204. MDPI AG. Retrieved from <http://dx.doi.org/10.3390/su11247204>
- Cardani, C (2020). The city as a theatre of characters. *John Hejduk's Masques. The city as a theatre of characters. John Hejduk's Masques*. Retrived from: https://rua.ua.es/dspace/bitstream/10045/116404/6/12_2021_9-2_04.pdf
- Chabrowe, B. (1974). On the Significance of Temporary Architecture. *The Burlington Magazine*, 116(856), 385–391. <http://www.jstor.org/stable/877732>
- Docherty, T (1993) *Postmodernism, a reader*. Routledge, London
- Falun 2027 (2021) Questionnaire for candidates https://www.falun.se/download/18.446d7d9c17b6e9dab-9fad308/1630609280016/Questionnaire_Falun2027_Draft%20version%20210831.pdf
- Falu kommun (2023) Översiktsplan och fördjupade översiktsplaner <https://www.falun.se/oversiktsplan-och-fordjupade-oversiktsplaner/antagna-fordjupade-oversiktsplaner/fordjupad-oversiktsplan-falu-tatort-och-området-runt-varpan/utvecklingsstrategi/utvecklingskarta.html>
- Frampton, K (1983) Towards a critical regionalism: six points for architecture of resistance. In *the Anti-aesthetic essays on postmodern culture* by Hal Foster. <https://www.oasejournal.nl/en/Issues/103/TowardsaCriticalRegionalism#012>
- Jodidio, P. (2016). *Small architecture*. Taschen.
- Laboy, M . Fannon, D (2016) Resilience Theory and Praxis: a Critical Framework for Architecture <https://www.semanticscholar.org/paper/Resilience-Theory-and-Praxis%3A-a-Critical-Framework-Laboy-Fannon/0f7571349694571f55c6168c1195cb3d-f29e69f9>
- Lepik, A. (2010). *Small scale, big change : new architectures of social engagement*. Museum of Modern Art.
- Lefavre L, Tzonis A (2003) *Critical Regionalisms, architecture and identity in a globalized world*. Prestel Verlag, Munich.
- Länsstyrelsen Dalarnas län (2023) Agenda 2030 https://www.lansstyrelsen.se/dalarna/om-oss/om-lansstyrelsen-i-dalarnas-lan/vart-uppdrag/agenda-2030.html?TSPD_101_R0=088d4528d9ab2000b473d03ff5fc37327208ceeac9a-b8ab9b504640b72b89fb5e28d136cd53b6dfc081599e2ed1430000110ab1eb033b9170d93a33427cb4900f9f6096c-08ba20b6fea01be2c14b0cfd34715507d461793bc520199f4d49f10e
- Madanipour, A. (2018). Temporary use of space: Urban processes between flexibility, opportunity and precarity. *Urban Studies*, 55(5), 1093–1110. <https://doi.org/10.1177/0042098017705546>
- Oswalt, P., Misselwitz, P., & Overmeyer, K. (2013). *Urban catalyst : the power of temporary use*. Dom Pub.
- Pidgeon, M (1995) *Space, Event, Movement*. Pidgeon digital retrived from: <https://www.pidgeondigital.com/talks/space-event-movement/chapters/>
- Power Station of Art, (2021). John Hejduk: Shanghai Masque. e-flux. <https://www.e-flux.com/announcements/432869/john-hejdukshanghai-masque/>
- Stockholm Resilience Centre (2014) Stockholm University https://www.stockholmresilience.org/download/18.5f8e906114d-44bc82f74c8/1459560295149/Annual_Report_2014_final.pdf
- Tschumi, B. (2023) Manhattan transcripts retrived from <http://www.tschumi.com/projects/18/>

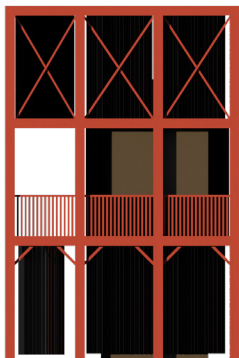

Erkka Juusela

*Chalmers University of Technology
2023
Rurban transformations ARKX03
Examiner Marco Adelfio
Supervisor Ida Röstlund*