

**MPDSD**  
CRITICAL SPATIAL  
PERSPECTIVES



**CHALMERS**  
UNIVERSITY OF TECHNOLOGY

**Anton Arnby, MT 2020**  
**Chalmers ACE**

**Supervisor: Nils Björling**  
**Examiner: Marco Adelfio**

**Rural**

# Microarcologies

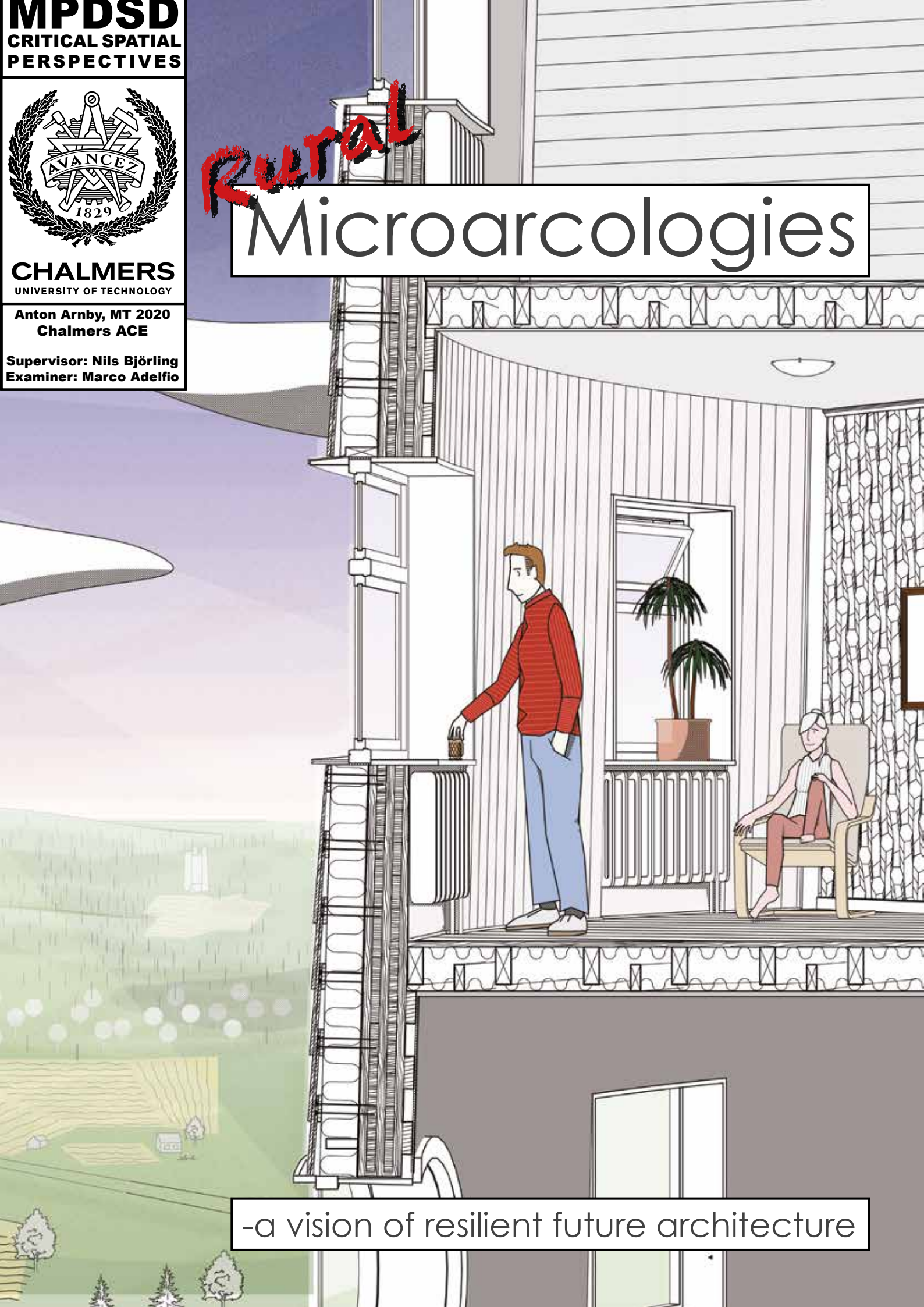

-a vision of resilient future architecture

# Abstract

With the advent of climate change, humanity is facing monumental changes. Overconsumption of resources and fossil fuels are leading us into catastrophic ecological decline, and the end of the growth-centered society we live in is arriving, whether through disaster or design.

Agriculture in Sweden is optimised for the smallest possible workforce and is largely dependent on fossil fuel. Repopulating the rural areas can enable the transition to a more sustainable agriculture, as well as making more variable and fulfilling lifestyles possible in a post-growth world, where personal satisfaction is not dependent on consumption of material goods and resources.

Using sequential art and storytelling, I propose a new type of dwelling that can improve the local agricultural communities and help create more sustainable lifestyles. This typology, dubbed Microarcology, is a dense dwelling operating at a high level of self-sufficiency, and works in concert with the surrounding community and landscape to create sustainable energy cycles while fostering social relationships on the local and regional scale.

The resulting design proposal is a vision of ruralisation that can provide inspiration for further discussions about the design of a sustainable future.



Anton Arnby  
Architect

Contact me:  
antonarnby@gmail.com

## Author Biography

I grew up in the small town of Rydaholm (pop. 1 600) and later the city of Växjö (pop. 65 000), as the youngest of three siblings in a middle-class family.

In my youth I was not very interested in architecture or design. Instead I spent my time playing and writing music. However, after a number of years as a music student, I pivoted towards architecture in my early 20s, wishing to work with something more substantial and meaningful than what I had, at the time, started to consider a self-indulgent art form with no clear benefit.

During my Bachelor education at Chalmers Architecture, I completed a number of design courses focusing both on building design and urban planning. After completing the programme, I spent a year at the architecture firm Arkitektbolaget in Växjö. This firm is somewhat renowned for designing timber buildings. During my time there, I worked on many different projects in different stages of development, but most of my time was spent on making detailed design drawings for a residential project, that is currently (2020) being built in Växjö.

As part of the master programme *Architecture and Planning beyond Sustainability*, I have worked with a planning project concerning allotment gardens outside a modernist Gothenburg suburb, a mixed-use urban block focusing on sustainable and energy-efficient design, and later a rural apartment building in the Local Context Studio, which focuses on problems and challenges surrounding smaller towns and their surroundings.

The rural landscape is very close to my heart, and its current demographic challenges are certainly troubling. I sincerely believe that the rural areas of the country will have to remain socially virile if we want to survive into the future. My Master's thesis project is an attempt to address these issues.

I have always had an interest in speculative fiction, especially Isaac Asimov and lately Liu Cixin. The method of this project is inspired by their ability to create scenarios for the future, based on contemporary issues, historical processes and scientific advancements.

Rural Microarcologies  
-a vision of resilient future architecture  
Anton Arnby  
Master's Thesis 2020  
Chalmers Technical University  
Department of Architecture and Engineering  
MPDSD  
Supervisor: Nils Björling  
Examiner: Marco Adelfio

Keywords: resilience, ruralisation, co-housing,  
shared spaces, cradle to cradle



**CHALMERS**  
UNIVERSITY OF TECHNOLOGY

# Table of Contents

|                        |    |
|------------------------|----|
| Author Biography ..... | 2  |
| Abstract .....         | 3  |
| Introduction .....     | 5  |
| Method .....           | 10 |
| Theory .....           | 14 |
| Delimitations .....    | 17 |
| Glossary .....         | 17 |
| Foreword: Comic .....  | 18 |
| The Comicbook .....    | 19 |
| PART 1 .....           | 20 |
| PART 2 .....           | 28 |
| PART 3 .....           | 38 |
| Summary & Result ..... | 42 |
| Reflections .....      | 43 |
| References .....       | 46 |

## Reading Instructions

My original intention was to make a fully readable Master's thesis in the form of comics. All the front matter and theoretical background would be presented in manner similar to Scott McCloud's theoretical works, of which *Understanding Comics* (McCloud, 1994) is a prime example. This has not quite panned out, and instead, what I present is a mix of comics and script.

The project itself is presented through a narrative with the use of comics.

In the comic, different fonts and styles of speech balloon serve to distinguish between different characters and contexts. Most notably, I use the **Courier** font for technical descriptions, narration and other non-diegetic texts. With this being the sole exception, all fonts used in the comic pages and other illustrations are gothic (which is customary in comics), and text apart from the illustrations (such as this one) use an antique font, to improve legibility. It is also worth mentioning that the speech within the comic is less formal than what would normally be expected from a Master's thesis.

## Reading comics

Comics are, in Europe, generally read from left to right, from the top row to the bottom row, and one page before the next. While I have mostly stuck to this basic reading order, there are some exceptions, such as dividing a page into columns, and the occasional spiral. The composition of the page and the placement of text should make this clear, but if you are at any time confused regarding the chronology of events or the sequence of an argument, I hope that you persevere, and try to read the page once more. If the exact chronological order of events is still not clear, you will hopefully have understood the content well enough to continue your reading regardless.

# Introduction

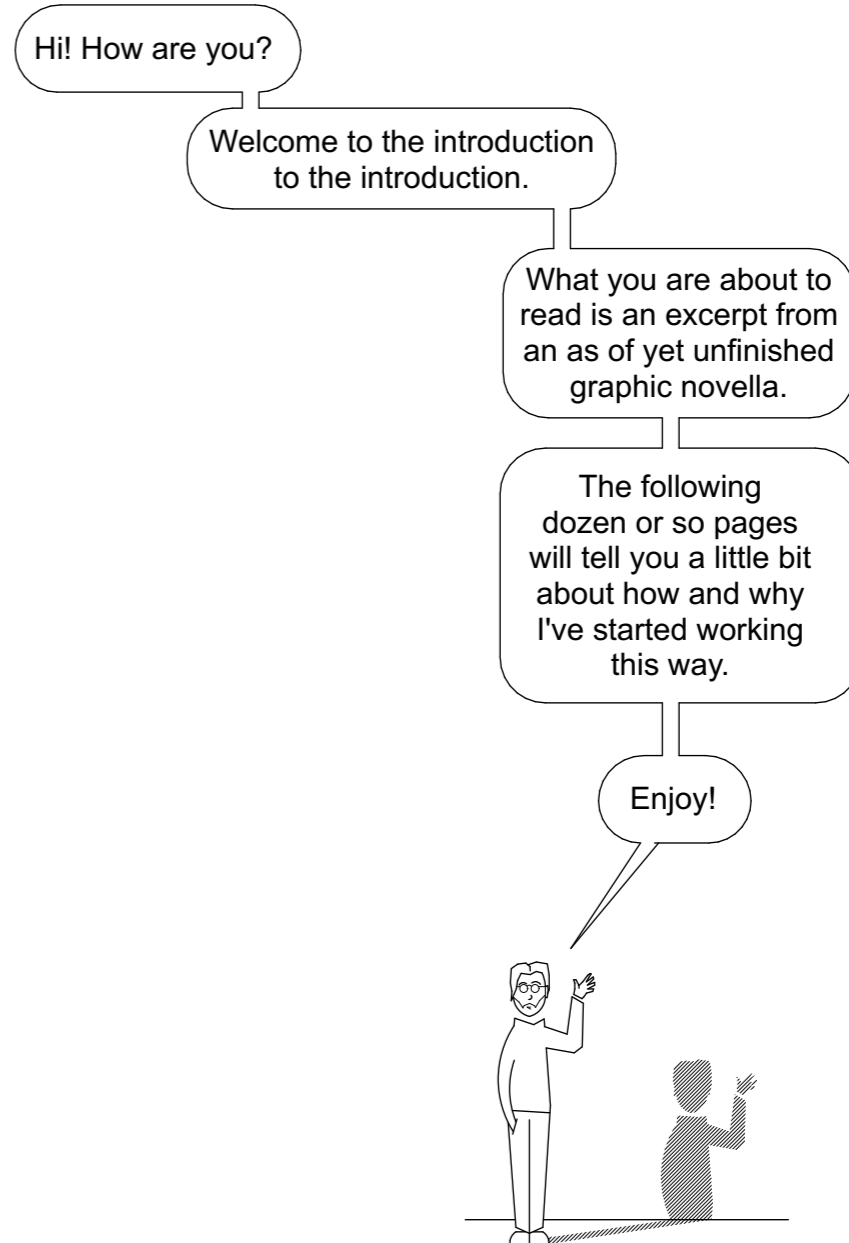

# Introduction

This document represents my second attempt at finishing a Master's thesis in architecture.

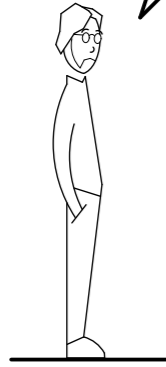

The original plan was to design a building that could fill a niche I thought was lacking in rural Sweden.

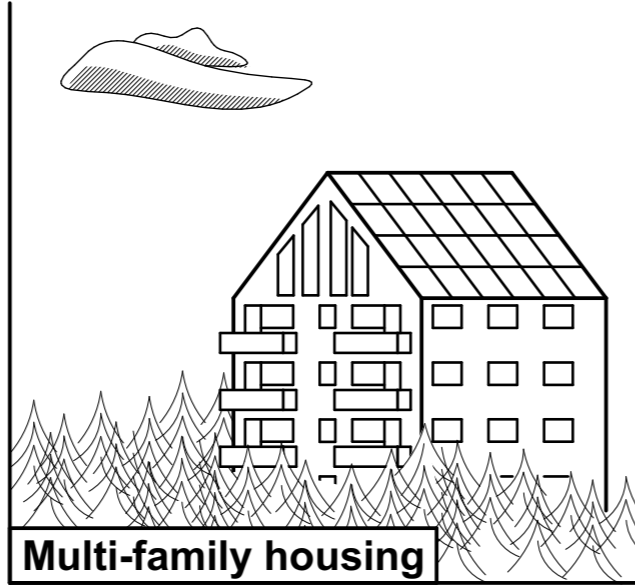

**Multi-family housing**

This building would offer a new way to live, while addressing some of the problems existing in the rural landscape today...

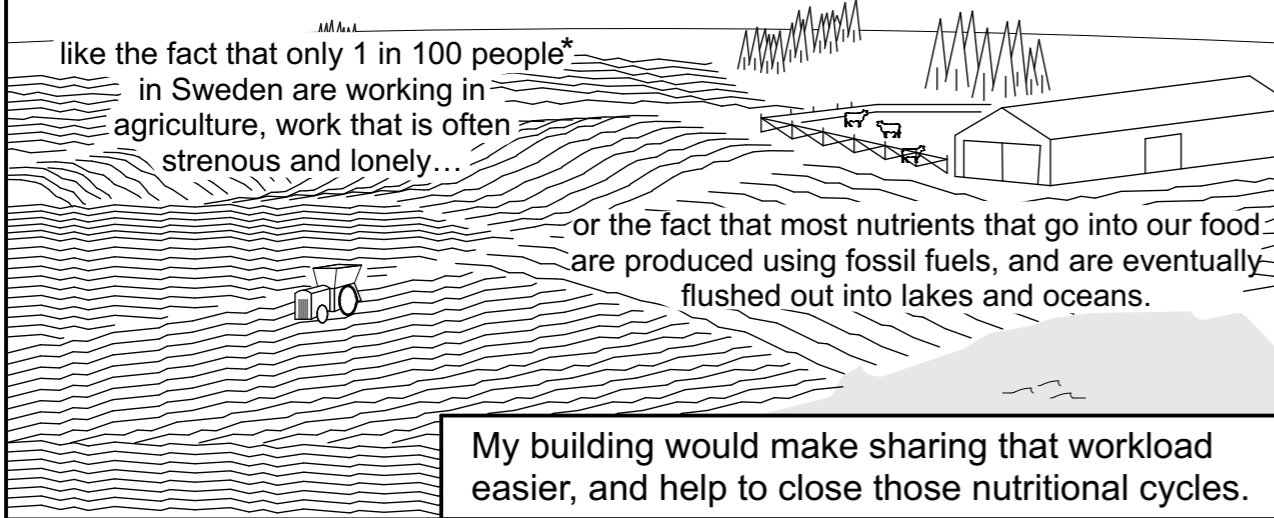

My building would make sharing that workload easier, and help to close those nutritional cycles.

**All this while being...**

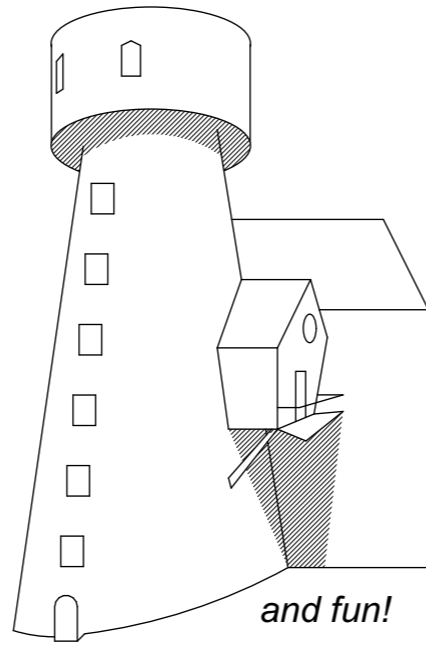
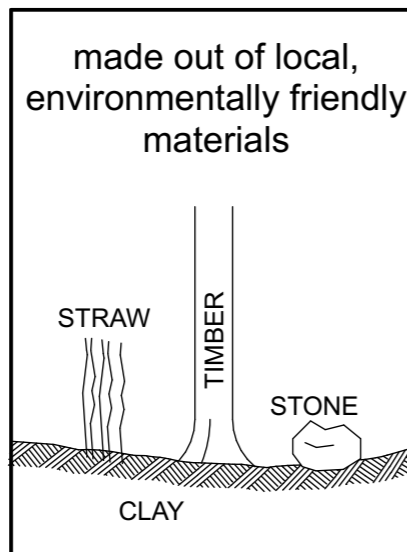
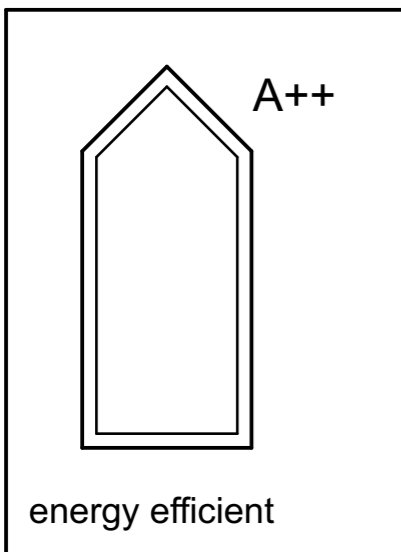

\*For further details regarding this and other topics described in the introduction, I refer you to the Theory chapter (p. 14).

I made many explorative sketches and designs...

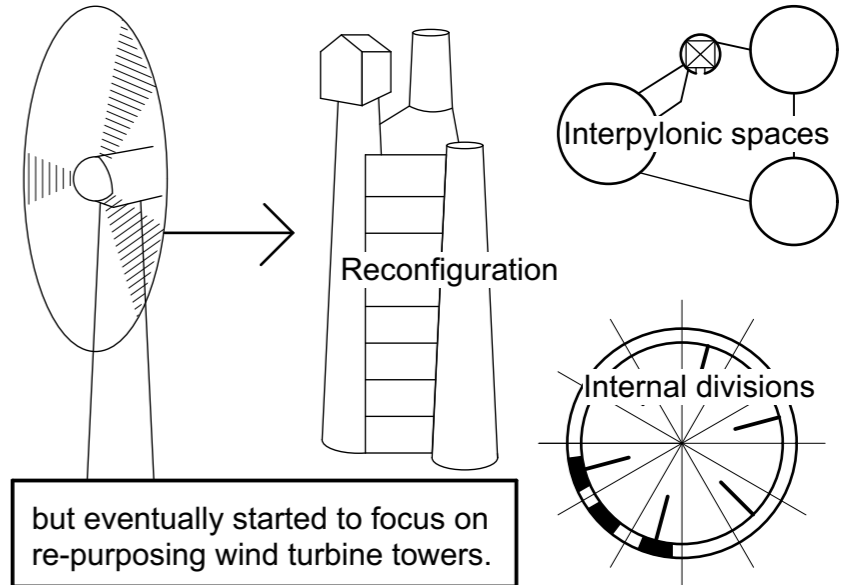
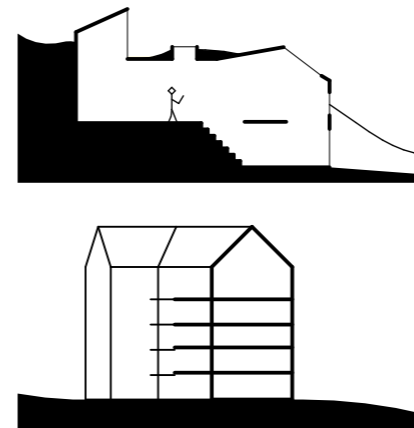

but eventually started to focus on re-purposing wind turbine towers.

I was making good progress, but...



I was getting increasingly unhappy and depressed.

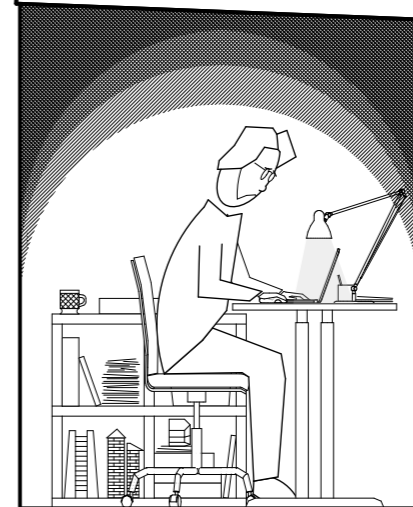

I decided to postpone the thesis.

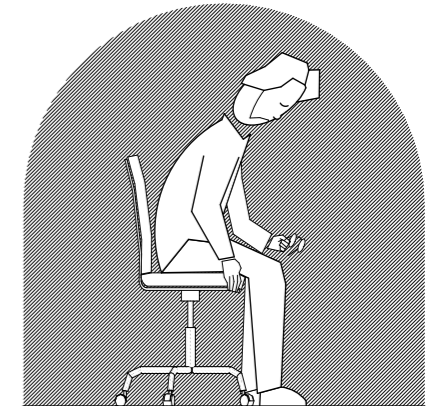

When it was time to start working again, I knew that I needed to do something differently, in order to finish the thesis.

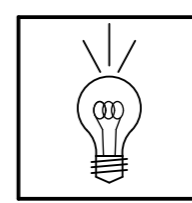
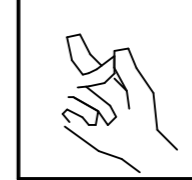

I am going to make this into a comic!

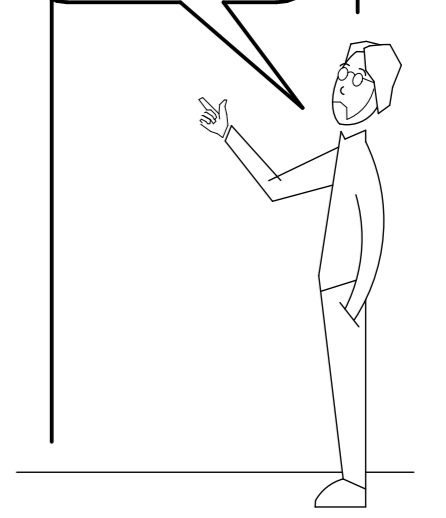

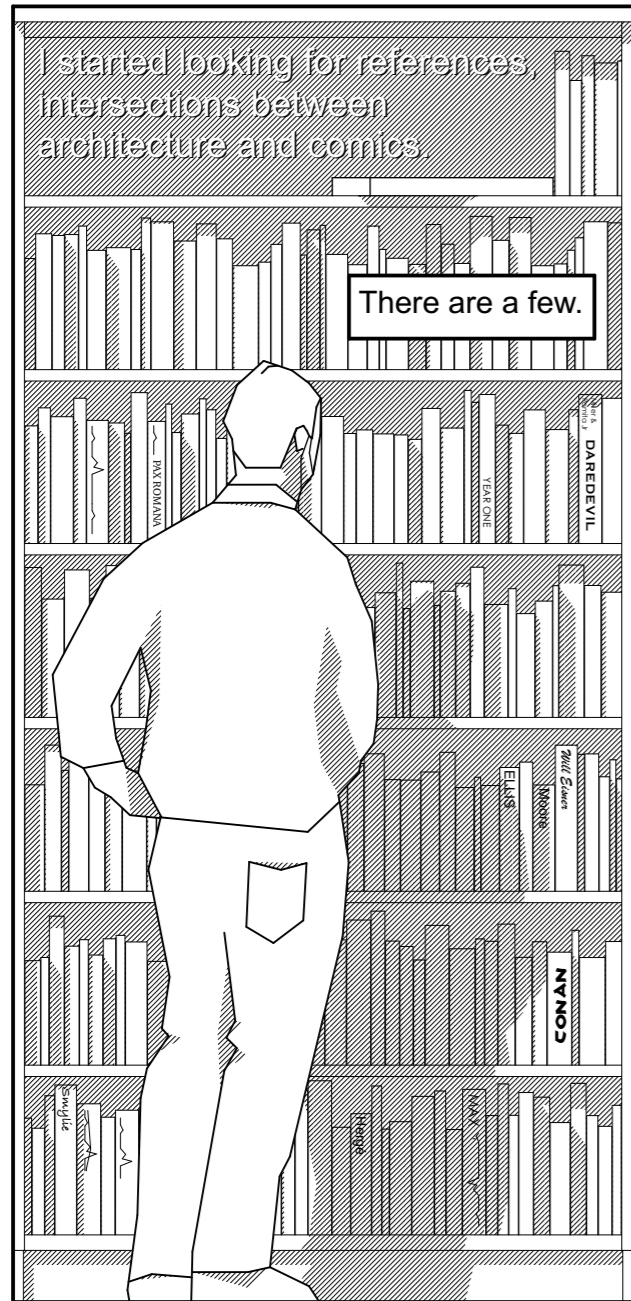
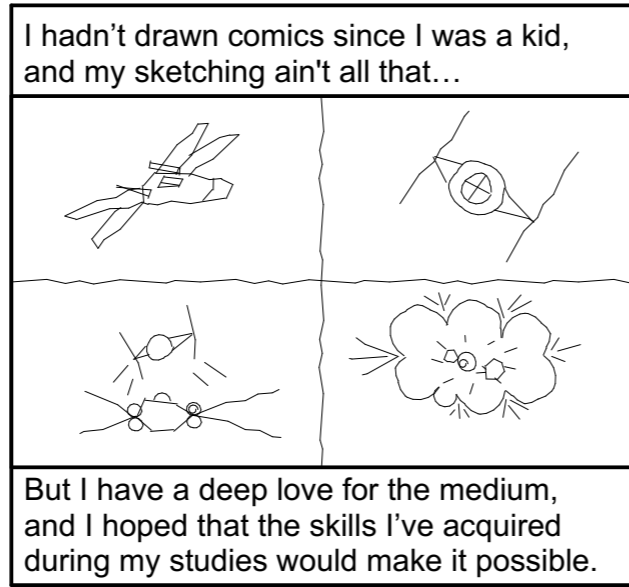
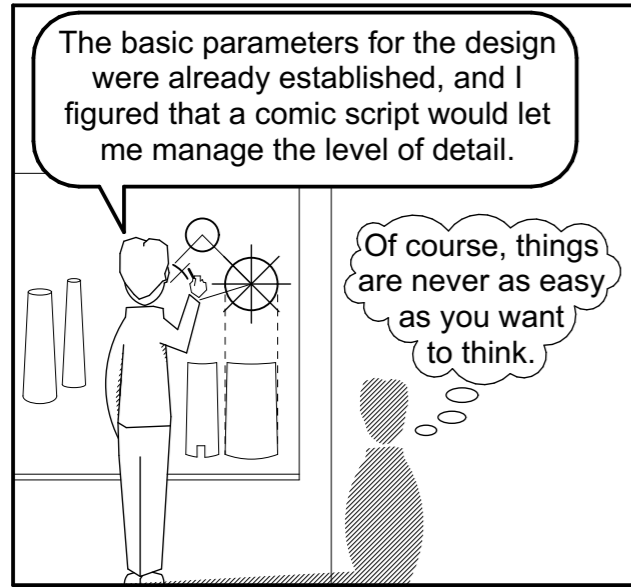

The protagonist of one of my favourite books, David Mazzuchelli's *Asterios Polyp* (2009), is an architect.

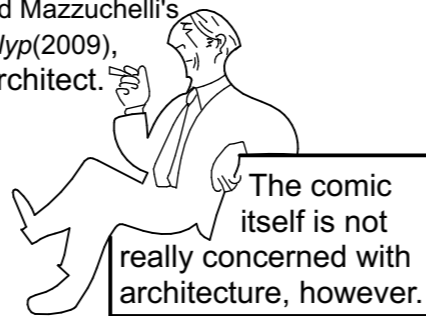

Instead, I looked to Chris Ware, who produced the brilliant *Building Stories* in 2012 (the most relevant among several astonishing works).

Ware is not an architect by trade, but the way his stories incorporate the space in which they take place is inventive and often extraordinary.

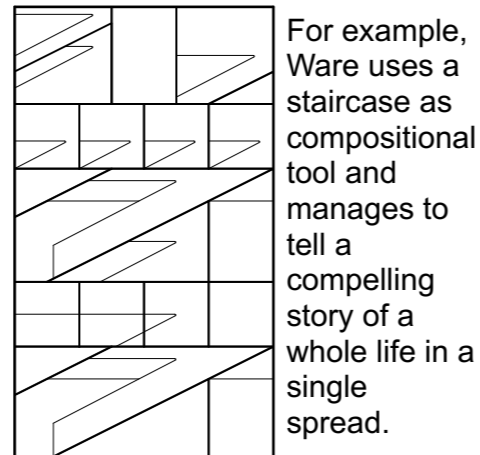

Author's analysis of spread from *Building Stories* (2012)

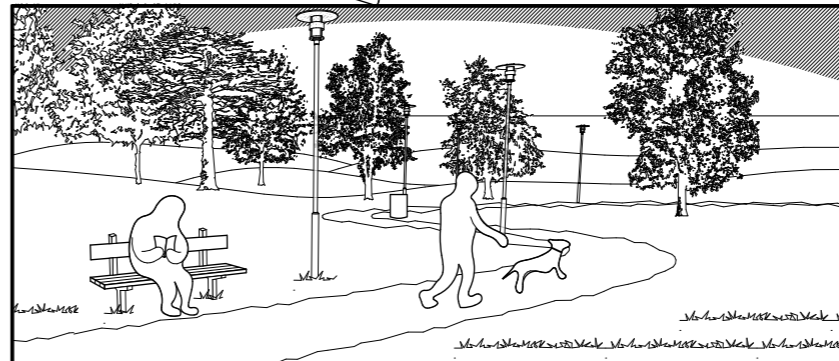
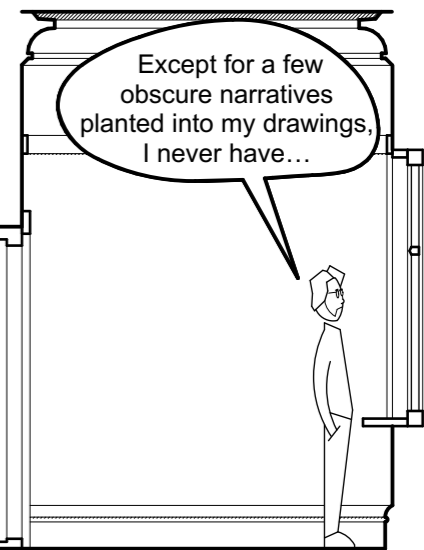
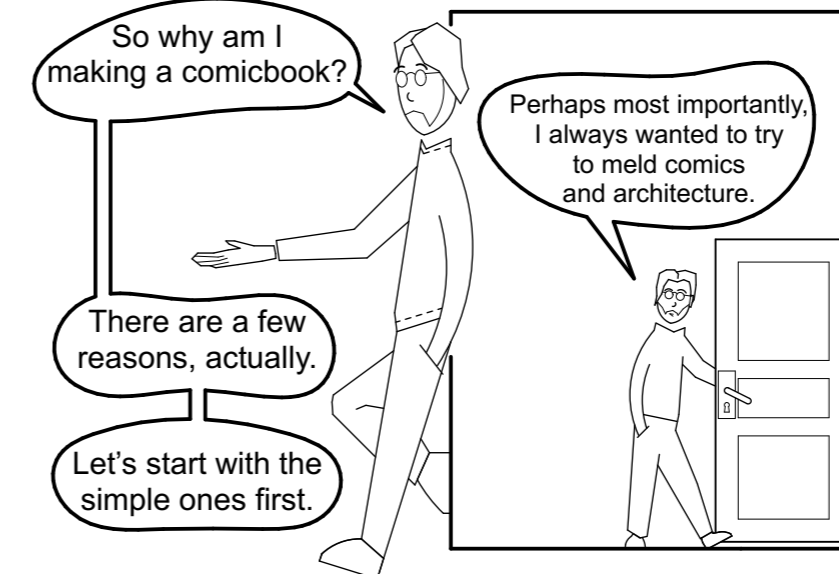
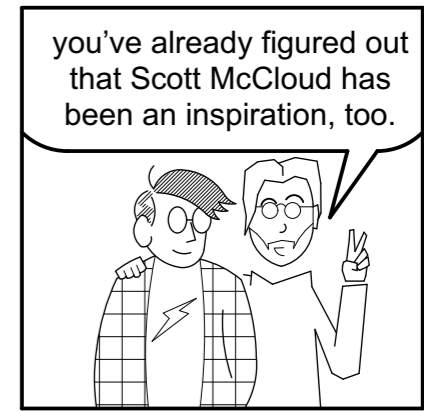
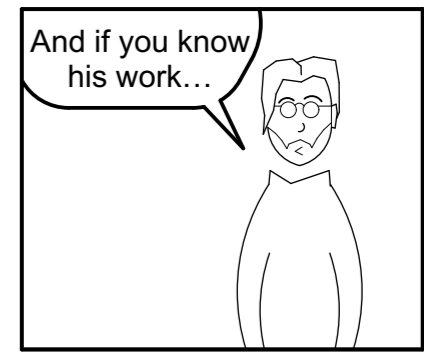
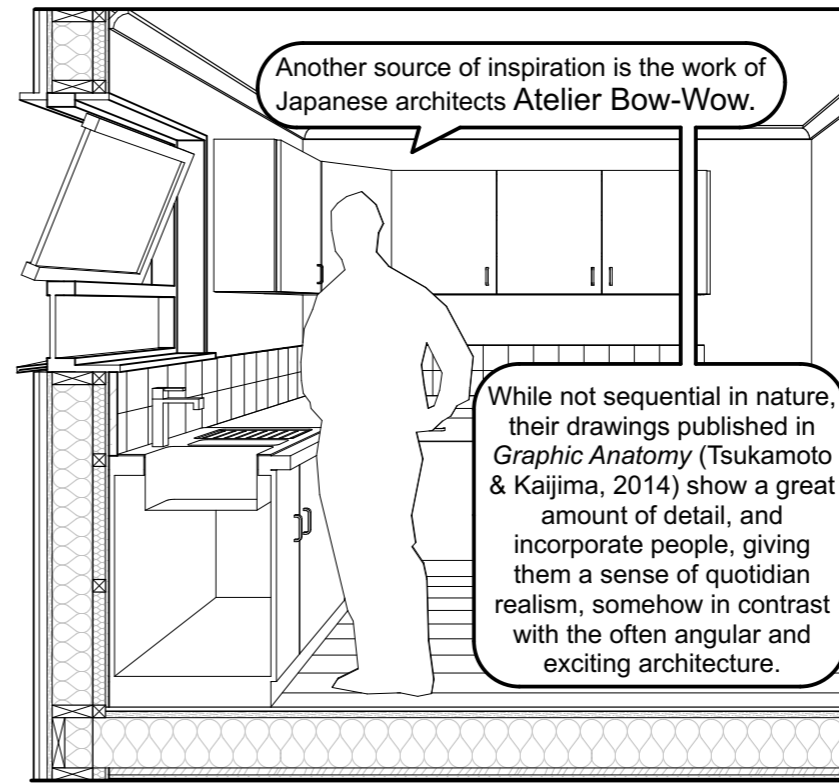

Secondly, I needed to do something that felt meaningful. Turning my master thesis into a comic would let it live it's own life, and hopefully reach people that normally wouldn't pay attention.

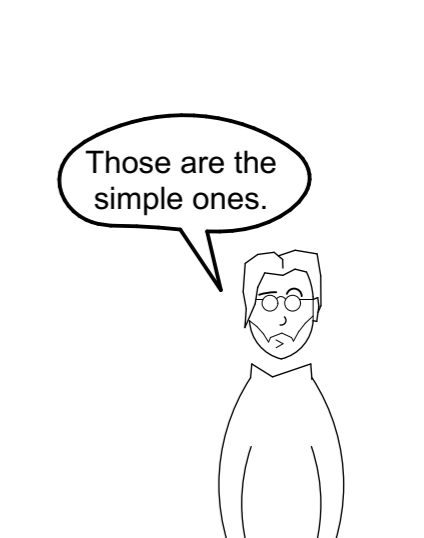

# Method

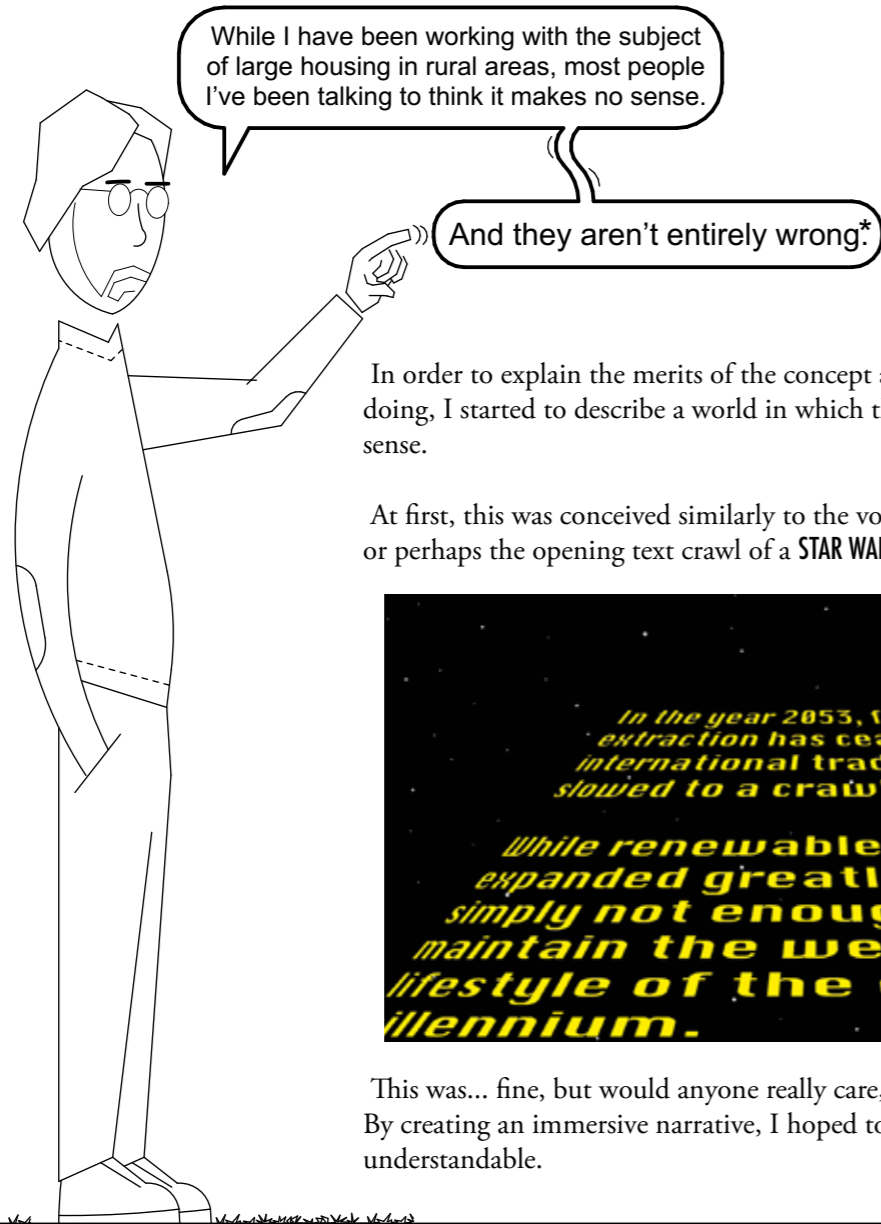

In order to explain the merits of the concept and justify what I was doing, I started to describe a world in which the typology *would* make sense.

At first, this was conceived similarly to the voice-over in a movie trailer, or perhaps the opening text crawl of a **STAR WARS** film.

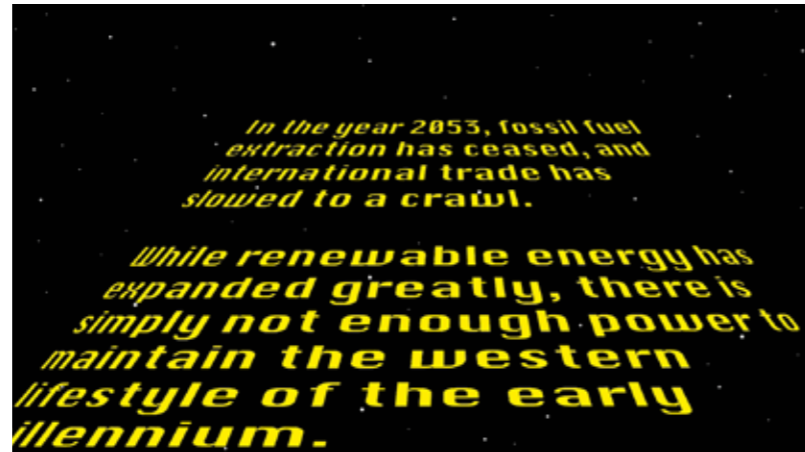

This was... fine, but would anyone really care, or take the time to read it? By creating an immersive narrative, I hoped to make my ideas more easily understandable.

Furthermore, as I started to define the parameters of the design, I realised that the building I wanted to design would not be one that was conceived in its entirety by an architect at his desk. Rather, the architect (or reconfiguration consultant) would establish the basic configuration of pylons, make rules for where openings could be made, and supply the inhabitants with ideas for how to create dwellings and spaces within this framework. The inhabitants would then be left to finish the building over time, serving both their practical and aesthetic needs.

With this in mind, I tried to inhabit the minds of these people, creating a timeline describing the successive growth of the dwelling. What would be built first? How would the function of different spaces change, as the building neared completion? I didn't do it to serve as the framework for a story, it was simply the only way I could think of, that would let me execute the project the way I wanted to.

So, after my hiatus, I decided that this is how I wanted to proceed with the thesis: creating and illustrating a narrative which could explain the building and the future in which it fits.

# The story to be told

In writing the story through which I would describe the Microarcology structure, a problem arose. The future I envisioned would have to be depicted realistically (and at the very least be somewhat plausible), but also attractive and hopeful. Perhaps not strictly utopian, but certainly leaning theretowards. Although utopianism has been subject to strong critique, utopian visions remain a powerful tool for imagining a better future, and a complete lack of utopian discourse can be considered troublesome (Pinder, 2002).

The problem that arises is, how interesting can a story set in a utopian society be? Is the description of the world/community/architecture enough to maintain interest? Perhaps, but I still felt that I needed an added element of drama. However, I also feared that this would conflict with the story's utopian vision.

Some of the more famous dystopias in fiction have narratives that revolve around the protagonist being in conflict with the society's laws and customs, for example *Brazil* (Gilliam, 1986), *1984* (Orwell, 1949) and *The Trial* (Kafka, 1925). It would not be unthinkable that if the same narrative structure was placed within a fictional utopian society, similar stories would result and a vision of dystopia would emerge from it. Similarly, the dystopias previously mentioned could certainly be misconstrued as utopian if described by an outsider. Of course, utopian societies do not typically exist in a geographical or narrative vacuum. The original Utopia is an island that exists among non-utopian societies (More, 1515). The utopian stages of human society described by Liu Cixin exist for centuries\*, but are still doomed, and serve only as the setting for small parts of the full story (Liu, 2010).



Out of this discussion, some distinct narrative ideas emerged.

1. The building as a utopian haven in a dystopian world
2. The utopian society as a background for a character's growth and self-realisation
3. AI as dissatisfied proletariat

I have worked with these three ideas, and number 2 has become the most prominent. The story is still very much a work in progress, and as I explore the building and its community, I can see that I am naturally moving towards a quite undramatic story, as I find the design and the medium itself sufficiently compelling.

# Making Comics

How do you make a comic? I am neither an experienced storyteller nor a comic artist, but I do have a few experiences that helped me structure my work. For example, I tried to outline the story diagrammatically, in a way that is similar to how I used to plan musical compositions. This process has only ever been moderately successful, but it makes for a good starting point to develop the different parts individually.

When it came to page layout and the individual images, I used my experiences as an architect, which includes laying out for posters and presentations, as well as the production of individual images.

## Story outline

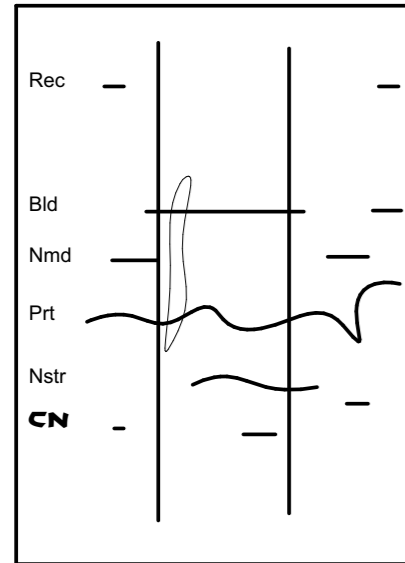

Here, I try to plan where and how different concepts, characters, and storylines are introduced.

## Scripts and thumbnails

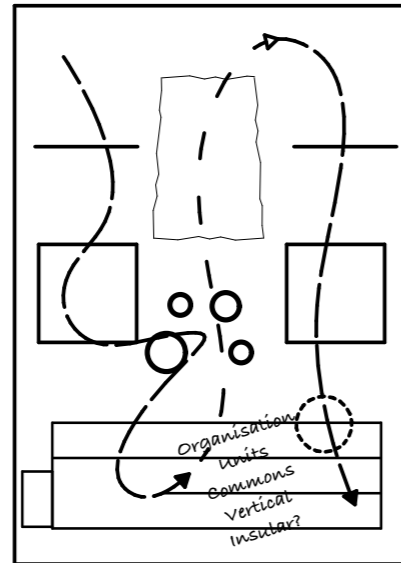

How do we fit the information we want into the page?  
How can we make the layouts both exciting and readable?

## Drawings

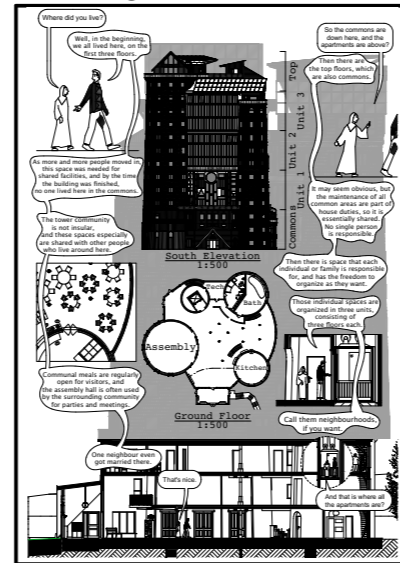

The pages are produced in ArchiCad based on the sketches and the script.

There has been a lot of trial and error. Something might seem like a good idea in a thumbnail, but when you try it on the page, the scale of the drawings might not work, for example. Also, I have sometimes written an outline of content for a page, done a layout draft, and only then written the dialogue and text\*.

My main source of guidance for comics-specific issues has been McCloud (2006). For comics inspiration, I have read works by Ware (2012), McKean (1990) and Groensteen (2009).

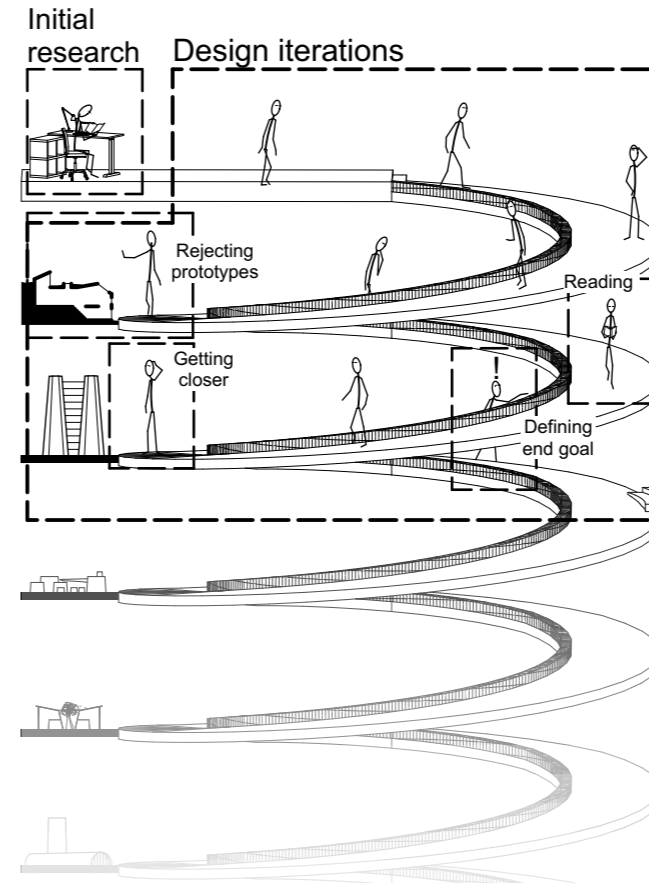

## Process

I started the project by testing a number of building designs. Eventually, I narrowed in on wind turbine pylons. Once I had a good idea of what I wanted to do, I started exploring the building from the perspective of its imagined inhabitants.

By observing these inhabitants, I could imagine how the building would be constructed and used, adapting the tower to the needs of different characters. These adaptations in turn have led to new needs, possibilities and wishes, and thus a cyclical work-flow of story, script and design was established.

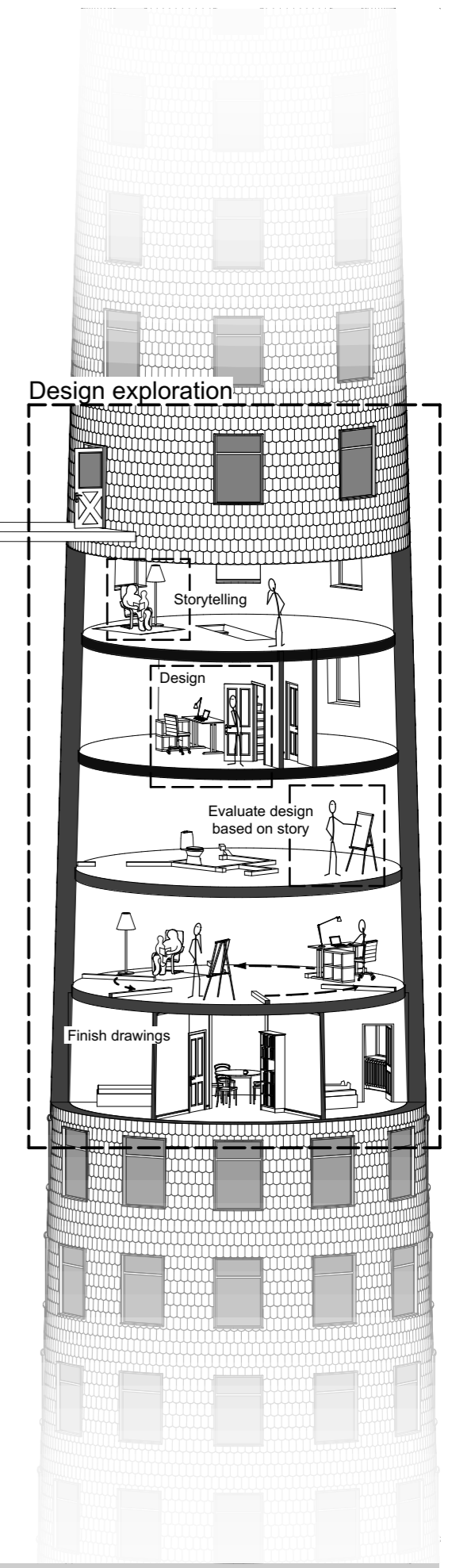

\*Which happens to be the preferred method of writer Stan Lee, apart from the fact that I am doing both the art and the writing.

# Theory

## The reading I have done for this project can be divided into three broad categories:

**Narrative**, which includes theoretical works on comics, and certain works of fiction and graphical art that have been particularly inspirational.

**Co-housing**, which includes texts concerning the organization of domestic and communal spaces, as well as descriptions of the raumplan ideas of Adolf Loos and Josef Frank, and Frank's Villa Beer in particular.

**Ecology**, which includes texts about transitioning from fossil-fuel dependence to a resilient society, and descriptions of how such a society might look.

Apart from sources in these three categories, I have also included a short text on the microarcology concept, as well as one regarding the wind turbine technology that has informed the project.



## Narrative & Comics

In *Comics and Narration* (Groensteen, 2013), the follow-up to his *System of Comics*, Thierry Groensteen deals with a myriad of issues regarding narration, iconography, page layout and rhythm. In Chapter 4.3 on digital comics, Groensteen critiques Scott McCloud's theoretical works, particularly his excitement over the possibilities of the infinite strip provided by the digital medium. Groensteen writes "[McCloud] takes scant interest in the page as a unit whose format is perfectly suited to the human eye", concisely highlighting the possibilities of iconographic layering and composition in print comics.

Groensteen also dedicates a subchapter to Chris Ware, describing both the idiosyncrasies of Ware's graphic language as well as his use of opposing pages to compare different situations. For example, Ware would let the space that on one page featured a symbol of death be mirrored by a representation of youth on the opposite page, or in a similar manner contrasting the domestic space of women with the domestic space of men in late 19th century Chicago.

Looking at all the examples I could find of comics using conventions of architectural drawing, it became clear to me that these almost never depicted the buildings accurately. The relation between rooms shown in section were not correctly placed or proportioned, even Chris Ware's buildings are simplified in certain ways. Thus, the challenges of writing comics within architectural drawings was to be something that I had to figure out more or less on my own.

# Co-housing

Katherlyne McCamant and Charles Durrett are both experienced architects who have worked with co-housing projects since the 80s. In their book *Creating Co-housing* (McCamant & Durrett, 2011), they present their inspirations and experiences from different co-housing communities. These projects differ in size and execution, but what connects them is a sense of community and a willingness to share responsibilities. Many co-housing projects feature common areas, such as washrooms, kitchen and kindergartens. In others, the only common areas are a yard and an assembly room.

McCamant and Durrett claim that the success of a co-housing project depends on its size, and in their experience, a group of between 40-50 adults is as large as it can get without decision-making processes becoming unwieldy. Responsibilities and workloads should remain fluid, to prevent conflict and discontentment. Some of the projects described are actually clusters of co-housing communities, in order to avoid larger groups.

Another important factor that is difficult to quantify is the sense of community. Were this "sense" to depend on a single factor, McCamant and Durrett claim that it would be the frequency of which meals are shared in the group, which means that the placement and design of kitchens and dining areas are very important.

Another element that distinguishes some of the more successful projects is how the different homes are spatially related to each other. Of specific importance is how people meet each other on their way to and from work in a way that makes socialising easy without becoming forced.

One source of inspiration for the design of this project was Villa Beer, a private residential house designed by Josef Frank in the 1920s. In *The House as Path and Place* (Long, 2010), named after Frank's own essay on the house, Christopher Long explains that Frank drew inspiration from medieval towns, and conceived the villa as a city in miniature. The path through the house (as one through a city) should be inviting, understandable and varied, as well as offering spaces for rest along it. Long (2010) quotes Frank as writing "The shortest path is not the most comfortable one, and the straight stairway is not always the best, indeed almost never" (pp. 490). The most inviting and interesting path through Villa Beer is indeed not the shortest, but Frank also supplies a second path hidden away in the building. These more rationally designed sets of stairs are, unsurprisingly, meant for the housekeeping staff. However, the two paths merge on the 3rd floor, where the more private spaces are situated.

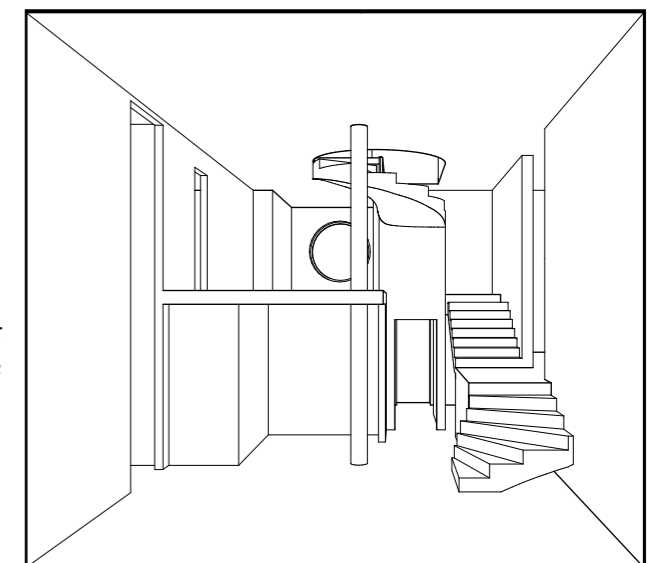

The main staircase of the villa interacts with both large rooms, like the living room between floor 1 and 2 (right) as well as smaller, undelineated spaces like the tea room (circular window) or the interior balcony, which originally served as a music room.

While Villa Beer was intended for a single family and their staff, the Beers soon fell on hard times, and were forced to rent the lower floors to, among others, a pair of opera singers (pp. 479). Sadly, there is no information regarding to how the house responded to this arrangement.

These sources have given some basic parameters to adhere to, as well as inspiration for how to approach the vertical communication and spatial planning of the building design.

# Ecology

Folke Günther is an ecologist and researcher who outlines the unsustainable nature of agriculture. Among the problems presented are dependency on fossil fuel for both labour and nutrient production, and alienation of agricultural workers from the rest of society. He concludes that a closer integration of settlements and agriculture (ruralisation) is the key to alleviating these issues, as it makes possible a higher degree of nutrient recycling\*, and allows more people to participate in agricultural work. (Günther, 2002)

In a lecture available on his website, Günther details a scenario for the ruralisation of a small Swedish town (pop. 33 000 in the urban center, 3 000 in rural periphery). Instead of replacing obsolete or spent structures, the scenario presupposes that the urban lands be instead remade as parks, and any new buildings be instead placed in groups of 4 “eco-units” in the town’s periphery. An eco-unit has a population of around 200, meaning that each new group has space for 800 individuals. The town keeps evolving in this manner, and after fifty years, the population numbers are reversed, and the municipality is a network of small villages, with a small urban centre with a population of only 3 000. This is, according to Günther, a settlement system that echoes the behaviour of advanced ecosystems, and may be the way to overcome some obstacles on the way to a sustainable society. Günther further clarifies that the essential difference between this scenario and urban sprawl is the integration of agriculture, and the fact that the inhabitants of these eco-units are not typically commuters, but work within their eco-unit or in a neighbouring unit. (Günther, 2001)

Author’s simplified illustration of 50-year ruralisation process as described by Folke Günther

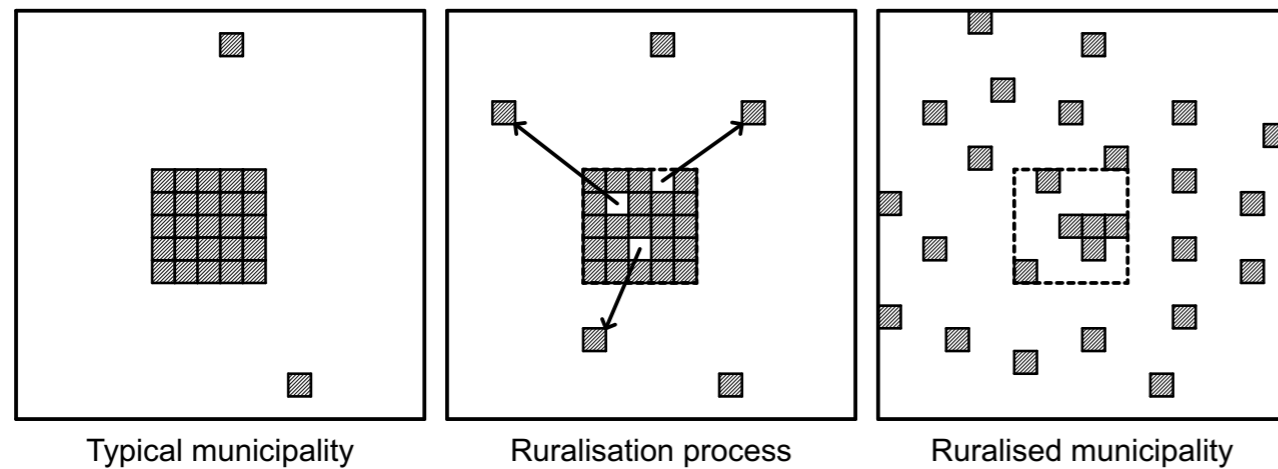

In *The Transition Handbook* (Hopkins, 2009), author Rob Hopkins writes about local approaches to sustainability issues (issues that have essentially remained the same in the decade since the publication of Folke Günther’s article referenced above). Hopkins also outlines the history of agriculture in Great Britain, of particular interest how local production and private gardens used to provide a significant amount of the nation’s food as recently as the 1940s.

## Wind turbines, Modvion, Reconfiguration

I have a distinct memory of one of my teachers telling me to look into reusing wind turbine pylons (although he claims it never happened) and thus, I started researching existing timber towers. The first one I found was a German tower\*\*, and according to a research paper (I regrettably have not been able to find it again), this structure had a pretty short lifespan. Wondering about how to utilize this fact, I started designing a building based on a cluster of such towers, thinking that they could support each other, and would be more stable without a turbine on top. This reconfiguration would give the structure a second life. However, the size and construction of the pylons were not at all suitable for my purposes.

A fellow student then told me about a start-up in Gothenburg called Modvion, that was also designing timber pylons for wind turbines. After talking to one of the engineers working for that company, as well as listening to an interview with their CTO (Wallnér, 2018), I decided to proceed with a design based on their pylon. Although I have no specific information regarding the lifespan of the Modvion pylon, I have simply made some assumptions loosely based on the lifespan of the German type.

\*Nutrient recycling, in this particular case, refers to the use of human urine and grey water as fertilizer.  
\*\*The company is simply called Timber Tower, and have already built a number of full-size towers.

# Microarcology

Since early in the process of this thesis, I have been using the term microarcology to describe my designs. For me, this term refers to a building that does two things: contains multiple facets of human society (i.e. work places, domestic spaces, recreational space) and facilitates a symbiotic relationship with the surrounding ecology, mainly by cycling nutrients.

The term microarcology is derived from Arcology, a term coined by architect Paolo Soleri in the late 60s. His conception of the term is essentially similar to mine, but as the prefix would suggest, is of a different scale. In projects and fiction describing arcologies, the structure typically provides a habitat for several thousand individuals. A microarcology is much smaller, and provides space for no more than a hundred people. My main justification for working with this size comes from McCamant & Durrett (2011), who describe the threshold for a non-representative but still functioning democracy as 40-50 adults.

It was only after I had used the term for some time that my tutor made me aware of an organization called the Haas Foundation (WDCD), a co-living group that is currently developing a number of what they call microarcologies in Central America. They describe a microarcology as “a small-scale architectural complex that integrates with the landscape and on-site ecology to provide a habitat for humans that takes care of all their basic needs while minimizing their environmental footprint”, which is similar to my own use of the term. They do not provide numbers for how many inhabitants their microarcologies would be able to house, but based on the site plans provided, it seems to be marginally fewer than what I’ve had in mind.

## Delimitations

The work within this thesis is visionary in nature. While I have made some rudimentary research on the possibilities of reconfiguration and other ideas presented, there are no underlying economic or structural calculations.

## Glossary

### Dystopia

A society or description of a society that is undesirable and does not provide basic securities for its inhabitants.

### Interpylonic space

The space between segments of a repurposed wind turbine tower (pylon).

### Microarcology

A building that contains multiple functionalities, and facilitates a symbiotic relationship with the surrounding ecology through the use of different technical systems.

### Reconfiguration

Reusing large structures for a new purpose, while making as few changes to it as is necessary.

### Resilience

The ability to recover from or easily adjust to misfortune or change.

### Utopia

A model of a society with near perfect qualities, where a dignified existence is possible for all inhabitants.

## Foreword: Comic

**There is really no point in denying that the comic included in this booklet is incomplete. I have included (and prioritised finishing) only a certain number of pages that I think are representative of the *architectural design* first and foremost. Therefore, you will not find any narrative resolution in the excerpt.**

The narrative arc of the full story revolves around a young person returning home, and his process of finding out what it is he wants to do with his life. In the course of this process, he will encounter different people, and their interactions will showcase the building design and the future scenario in which the project exists.

The story is divided into three parts, the first of which takes place over a half day, during which our protagonist, Pete, is traveling towards his childhood home. In this part, we meet a number of characters who discuss the main concepts of the building design, but mostly the society that surrounds it.

The second part takes place in and around the building, and explores in closer detail how it was constructed and how it is organized.

The third part concerns daily life in the building, and serves to tie up the narrative threads presented in earlier parts.

|                        |                                   |
|------------------------|-----------------------------------|
| Part 1: Regional scale | Basic ideas, future scenario      |
| Part 2: Building scale | Architectural design              |
| Part 3: Local scale    | Life in the tower, other projects |

I have included further details regarding the excluded parts of the comic at the beginning and at the end of each excerpt.

# The Comicbook

Being an excerpt of a planned graphic novella concerning the development of Microarcology structures in Sweden

# PART 1

Part 1 will introduce the main concepts of the building design, but is mostly concerned with elaborating on the society in which it exists.

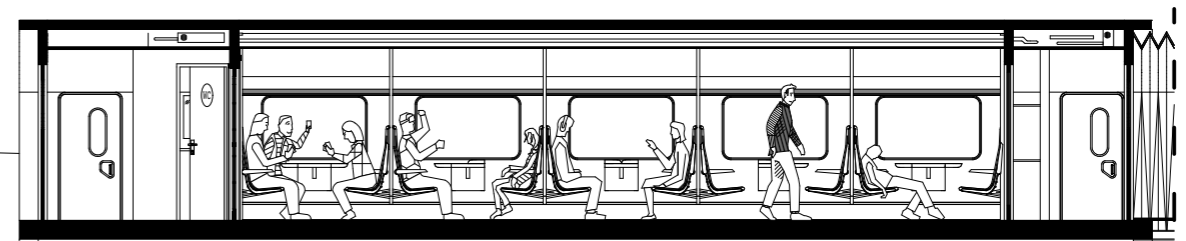
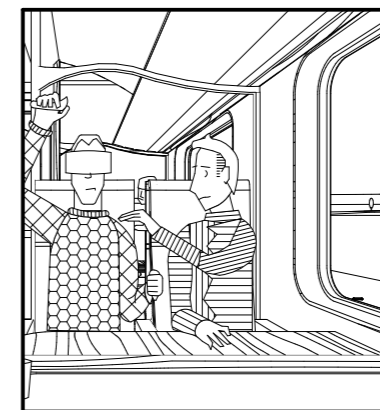
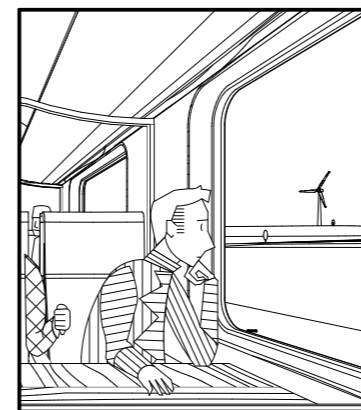
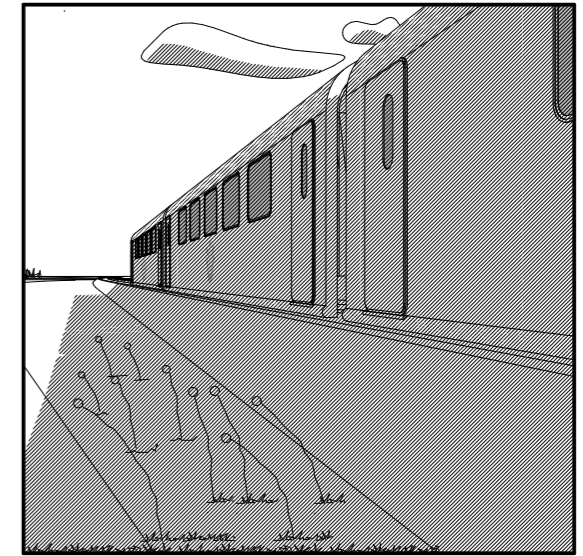
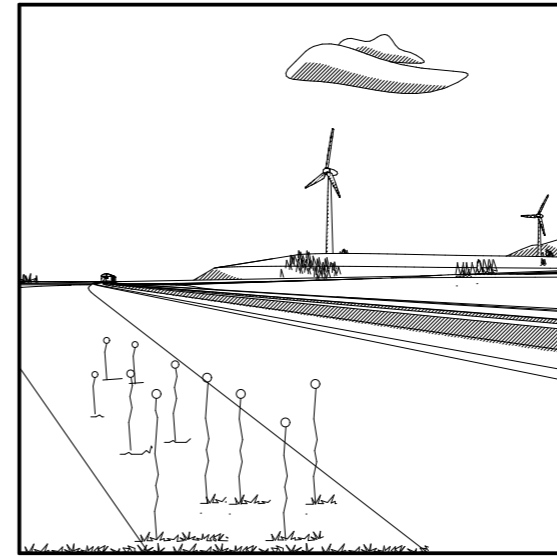

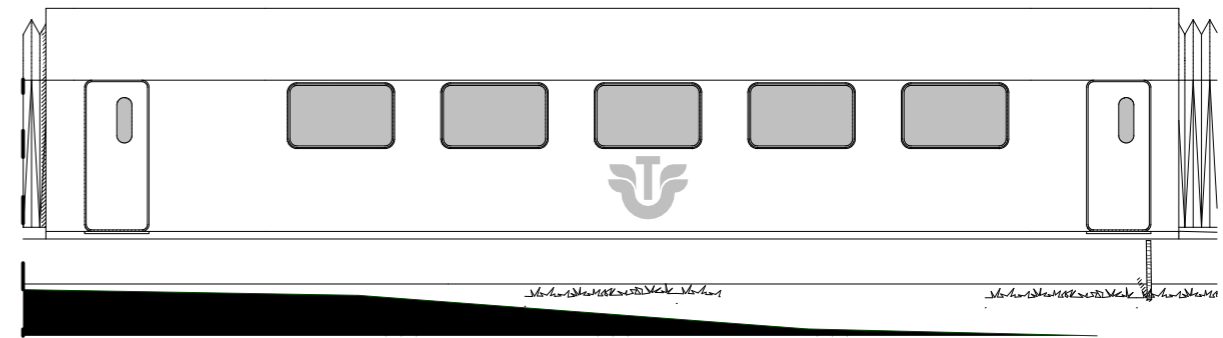
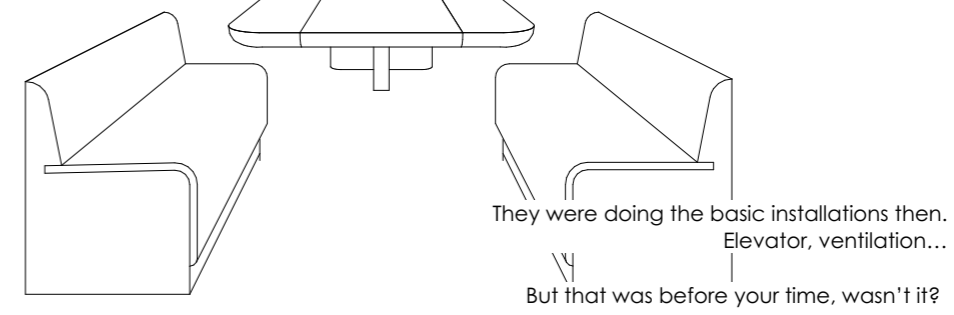
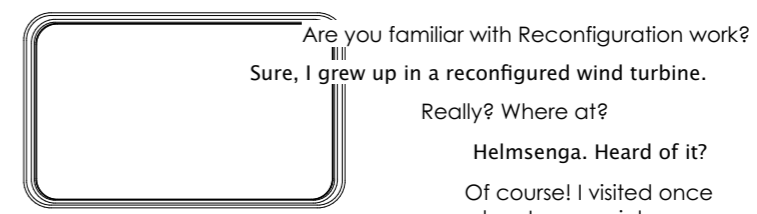
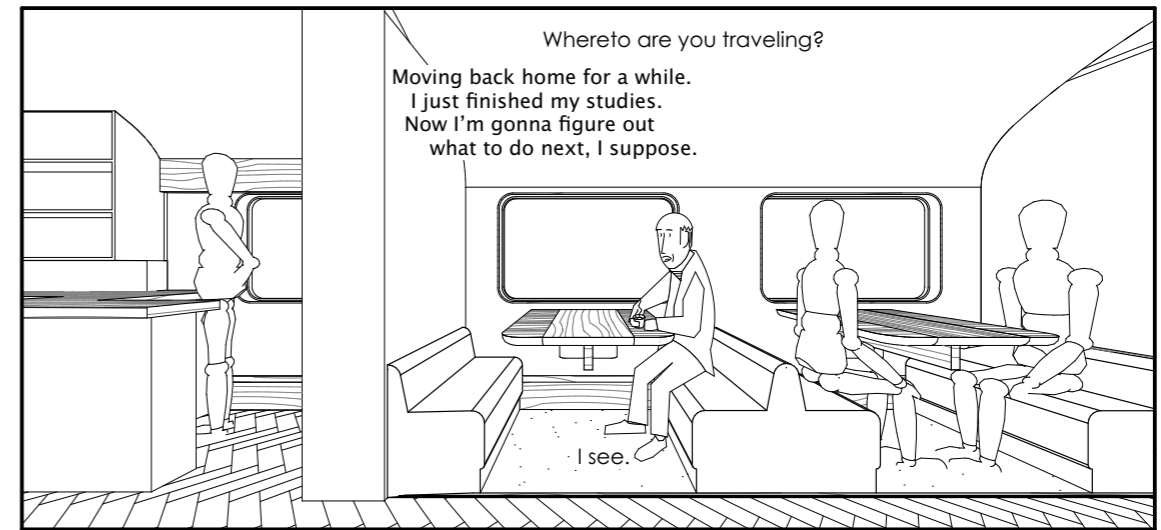
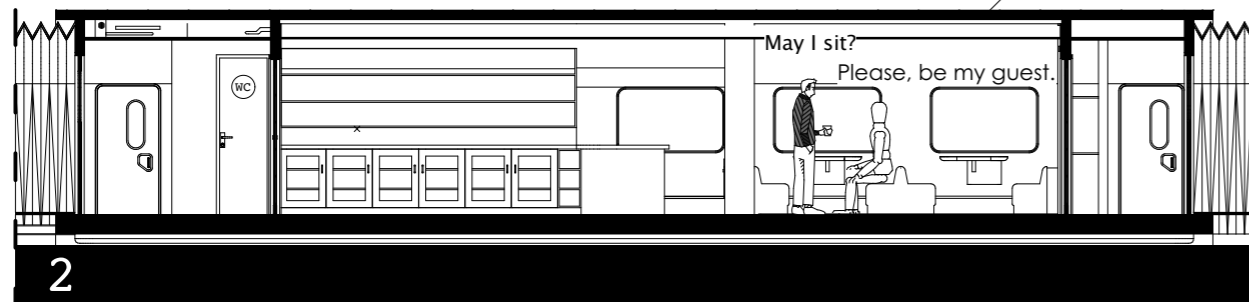
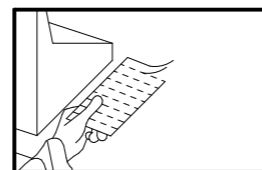
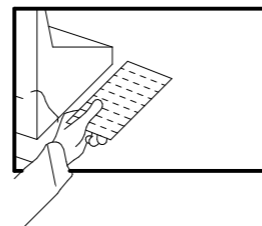
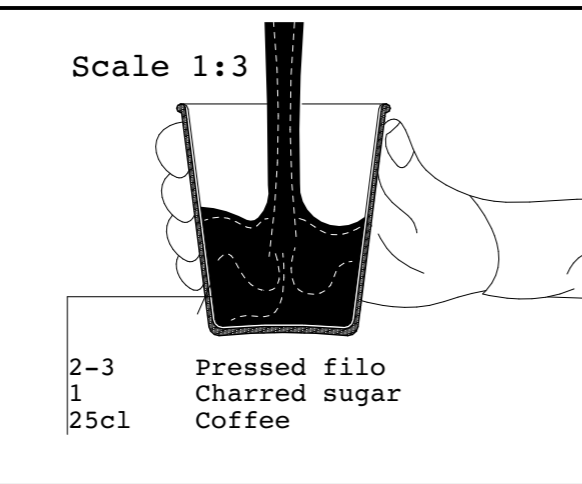
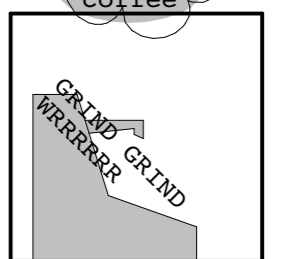
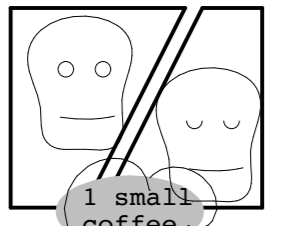
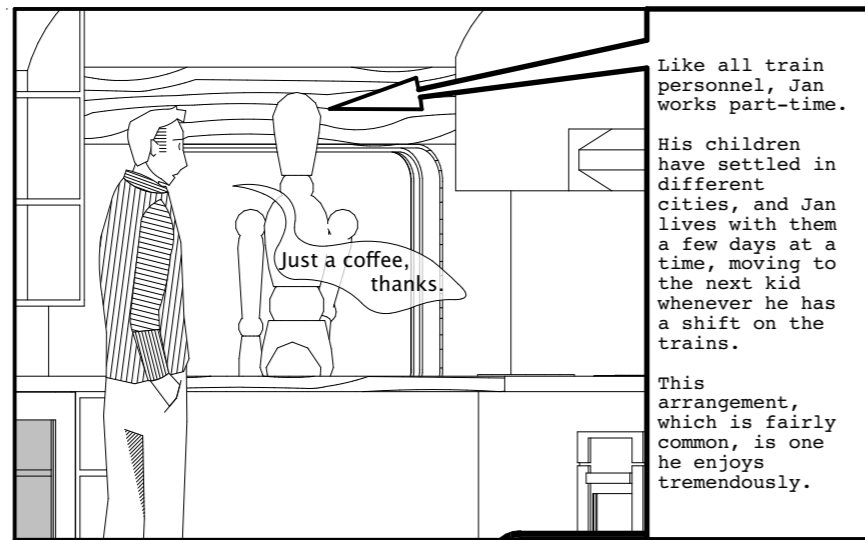
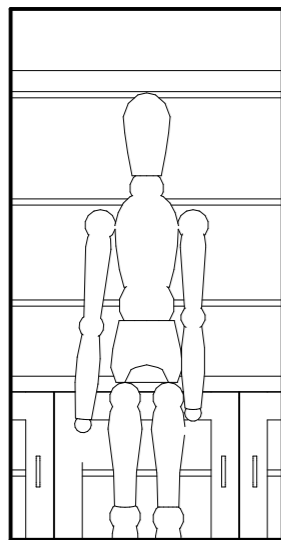
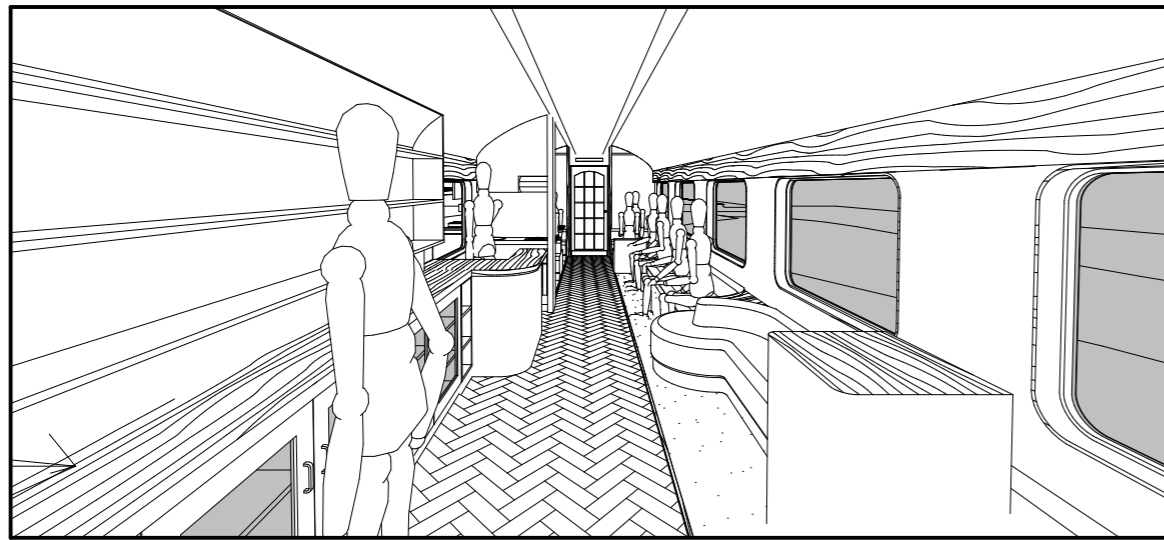

We moved in when I was a year old, just after basic installations.

My first two years we lived in a caravan on the foundation.

So you practically grew up on a building site!

Tell me, what do you recall from those early days of the tower?

Well, when I was 7 the association bought enough glazing to enclose the full interpylonic space.

Once the glazing was there, a whole lot more people started showing up. It was just a few years until we decided that the tower was done.

Enclosing has been an obstacle for many towers, I'm afraid.

It has become more and more common to make it part of basic installations. It speeds up the habitation process considerably.

Although, I must confess, there is a certain charm to those early towers, looking like old quilts.

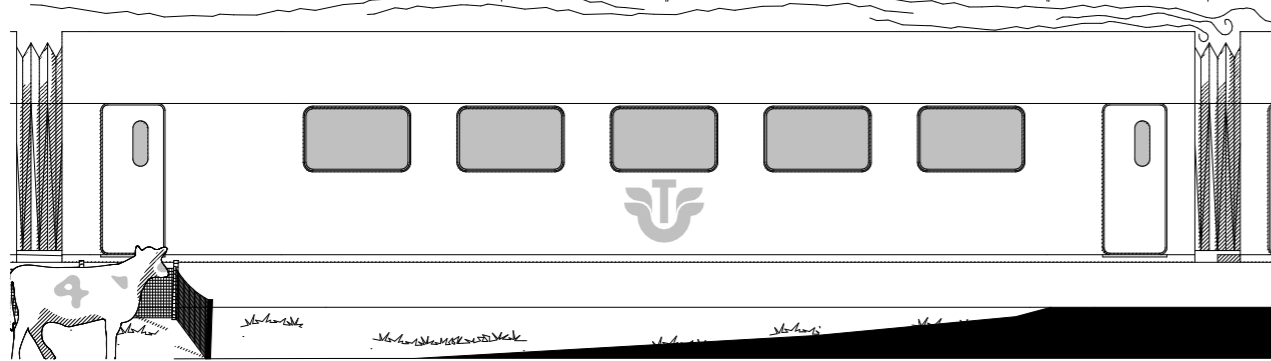
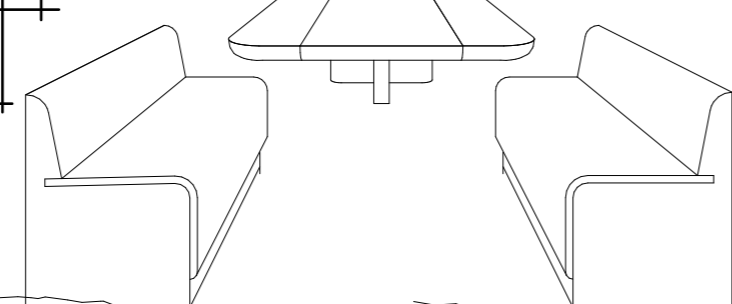
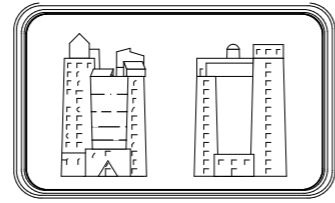
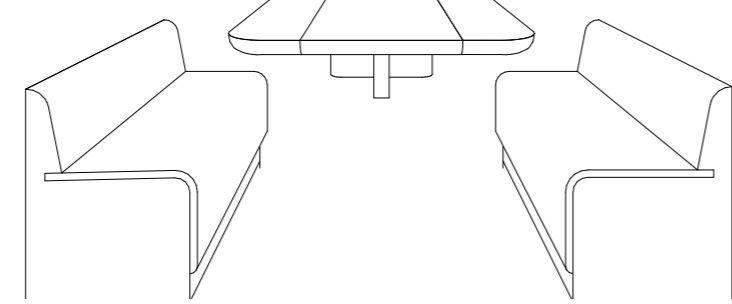
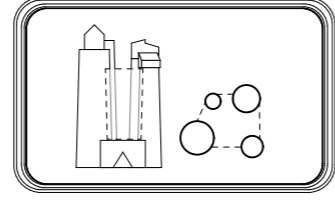
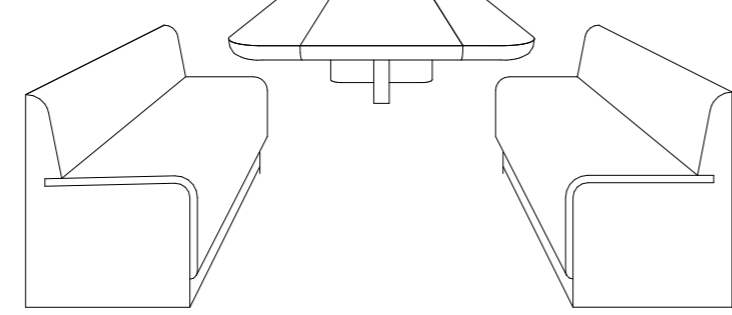
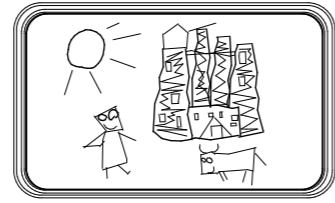

OUR STOP IS FAST APPROACHING  
WANTER YOUR BELONGINGS

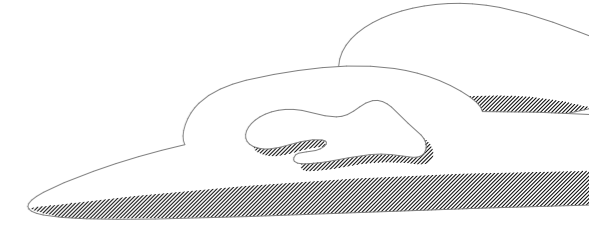
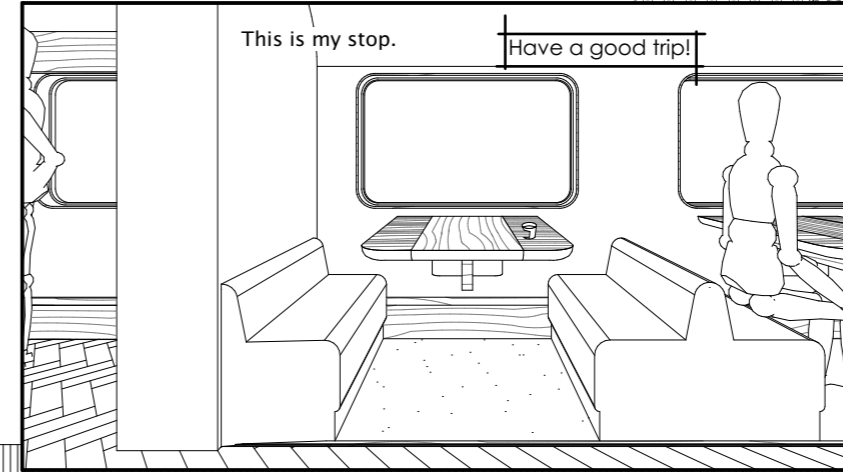
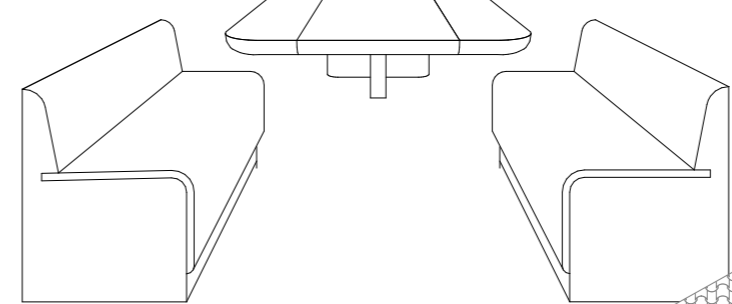
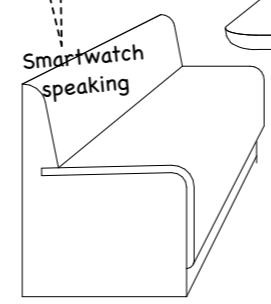
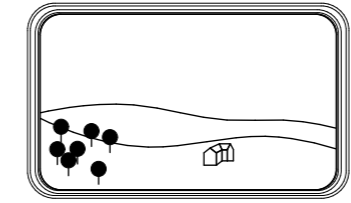

All the way to Kalmar, and then north along the coast.

There is a reconfiguration for a monastery in Oscasham that I am going to oversee.

This is my stop.

Have a good trip!

Smoland, 2071

Alvesta, pop. 16 000

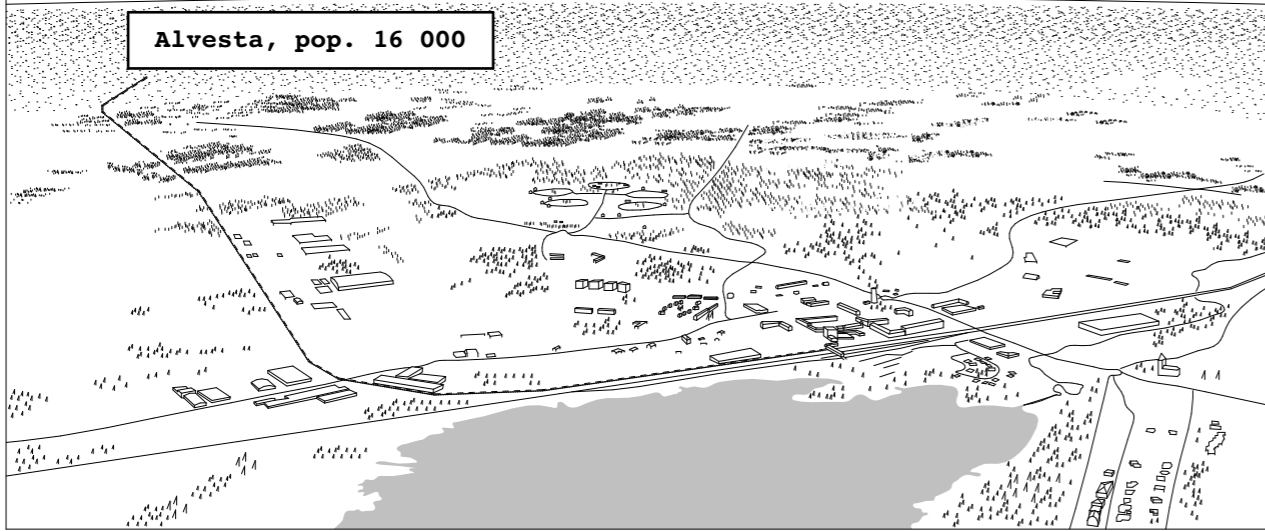

Fossil fuel extraction ceased globally in the 20's

Energy shortage has necessitated a higher degree of local self-sufficiency

International trade has slowed to a crawl

Map of southern sweden?

Post terminal rebuilt as greenhouse

Population growth in urban centers has been stagnant since 2034

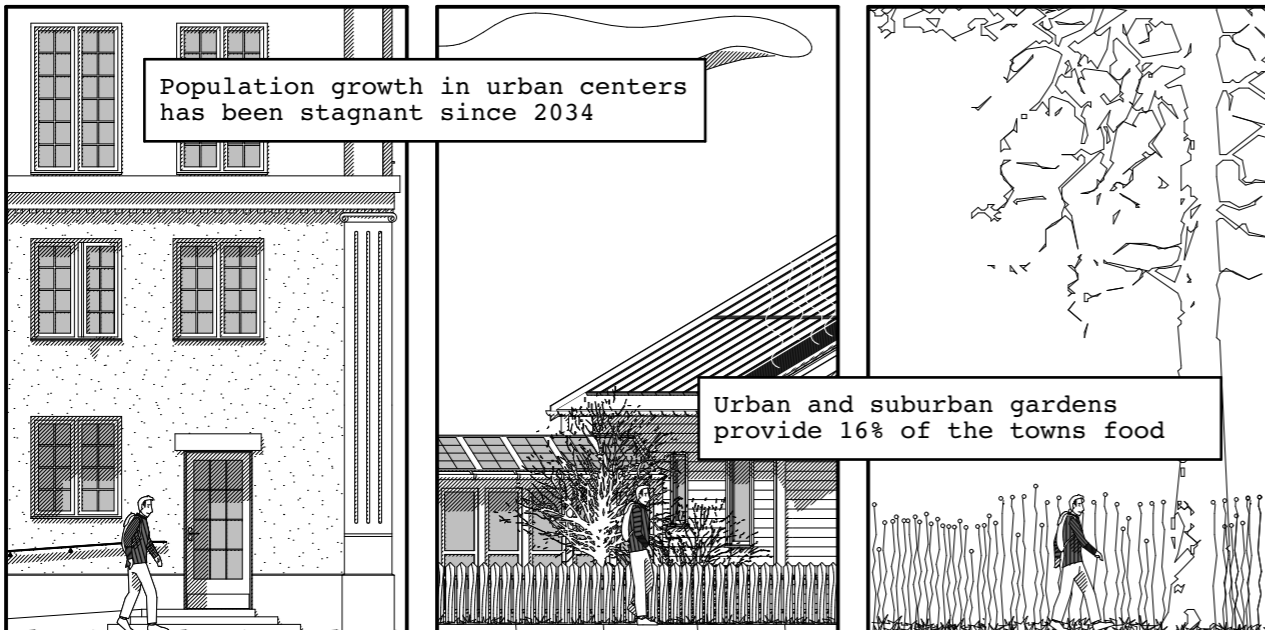

Urban and suburban gardens provide 16% of the towns food

Part 1 continues with further explorations of how the world works, shown through the protagonist's discussions with the other persons in a shared car.

Stories that they tell etc.

In the end of part 1, the car arrives at Helmsenga in rural Smoland, the location of a number of farmsteads and a reconfigured wind turbine tower.

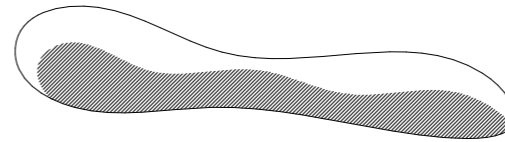

# PART 2

In part 2, our protagonist returns to his childhood home in the company of Saga, an older woman visiting her son, who has recently moved into the tower.

Pete shows Saga around, and talks to her about the building and its history, taking a tour of the building from the bottom to the top. On the 9th floor, they meet Nestra, who has been part of the Helmsenga community since its inception. She also helps to tell the story of the tower, following Pete and Saga to the top of the tower, where they continue to discuss the building and its impact on the surrounding landscape.

A centrefold shows the building in its various stages of development with a series of 8 elevations.

Continuing on, our protagonist meets old and new acquaintances, and has dinner in the commons. After a long day, he settles down in a guest room and prepares for the next day.

Helmsenga, summer 2071

This used to be a wind turbine?

Yes, and it stood here for 25 years before it became this tower.

Once the pylon starts to wear out, it's not safe anymore, and you have to reconfigure.

Why didn't they just build another wind turbine?

Couldn't they have reused the old pylon somewhere else and put a new one here?

The wind power was never really the goal. If you just want to harvest wind power efficiently, you could just build those huge parks, like in the north or on the coast.

Creating this building was always the plan.

The wind turbine stood here for 25 years, generating the power and finances to make it possible.

And you grew up here?

Yep.

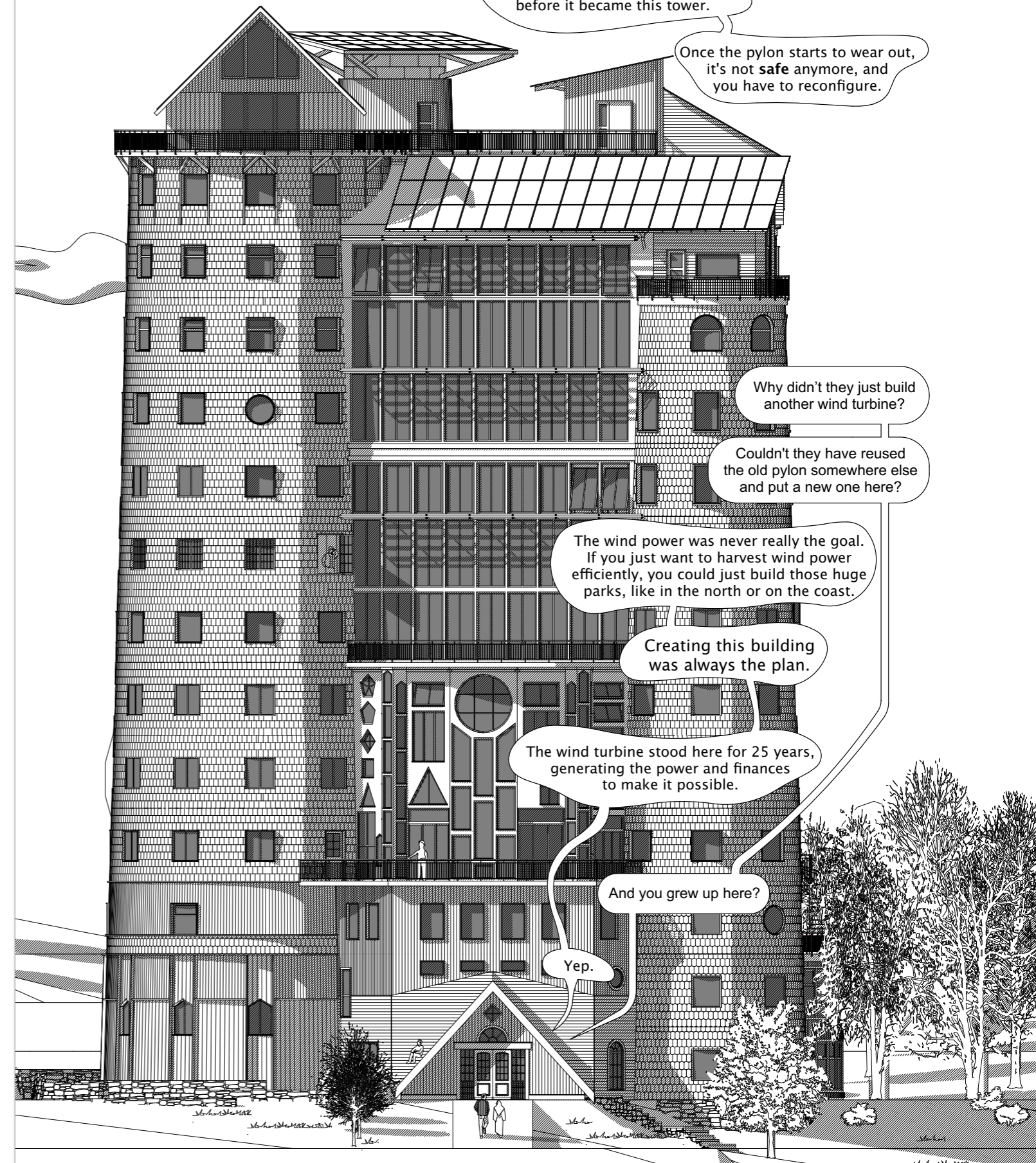

Where did you live?

Well, in the beginning, we all lived here, on the first three floors.

So the commons are down here, and the apartments are above?

Then there are the top floors, which are also commons.

As more and more people moved in, this space was needed for shared facilities, and by the time the building was finished, no one lived here in the commons.

The tower community is not insular, and these spaces especially are shared with other people who live around here.

It may seem obvious, but the maintenance of all common areas are part of house duties, so it is essentially shared. No single person is responsible.

South Elevation  
1:500

Then there is space that each individual or family is responsible for, and has the freedom to organize as they want.

Those individual spaces are organized in three units, consisting of three floors each.

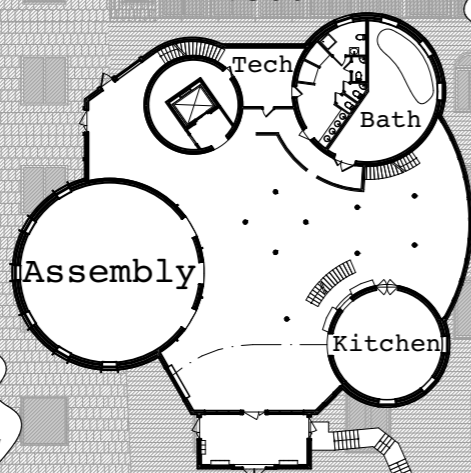

Ground Floor  
1:500

Communal meals are regularly open for visitors, and the assembly hall is often used by the surrounding community for parties and meetings.

Call them neighbourhoods, if you want.

One neighbour even got married there.

That's nice.

And that is where all the apartments are?

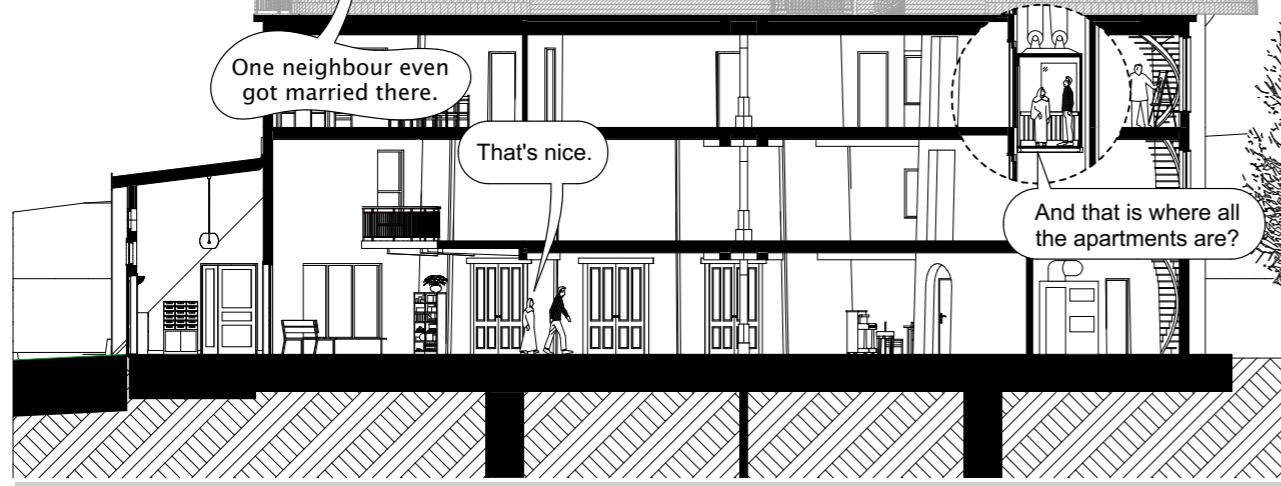

There are apartments, yes, but also workshops and other spaces.

The medical is not in the commons, for example.

It's in the first unit.

In the bottom floor of each unit, there are some shared functions too.

Medical space

Bathroom...

a smaller kitchen...

and some box gardens.

The rest of it are personal spaces, but not just apartments.



Hi Pete!  
We're having fika!  
Join us!

We lived in that pylon.

We moved here three years ago. This space was great for us, and we haven't made any big changes.

How long you will be staying, Pete?

I really don't know.

That niche used to be my little space, where I had my bed, my toys and books.

But it's my stuff now...

There is nowhere else I need to be.

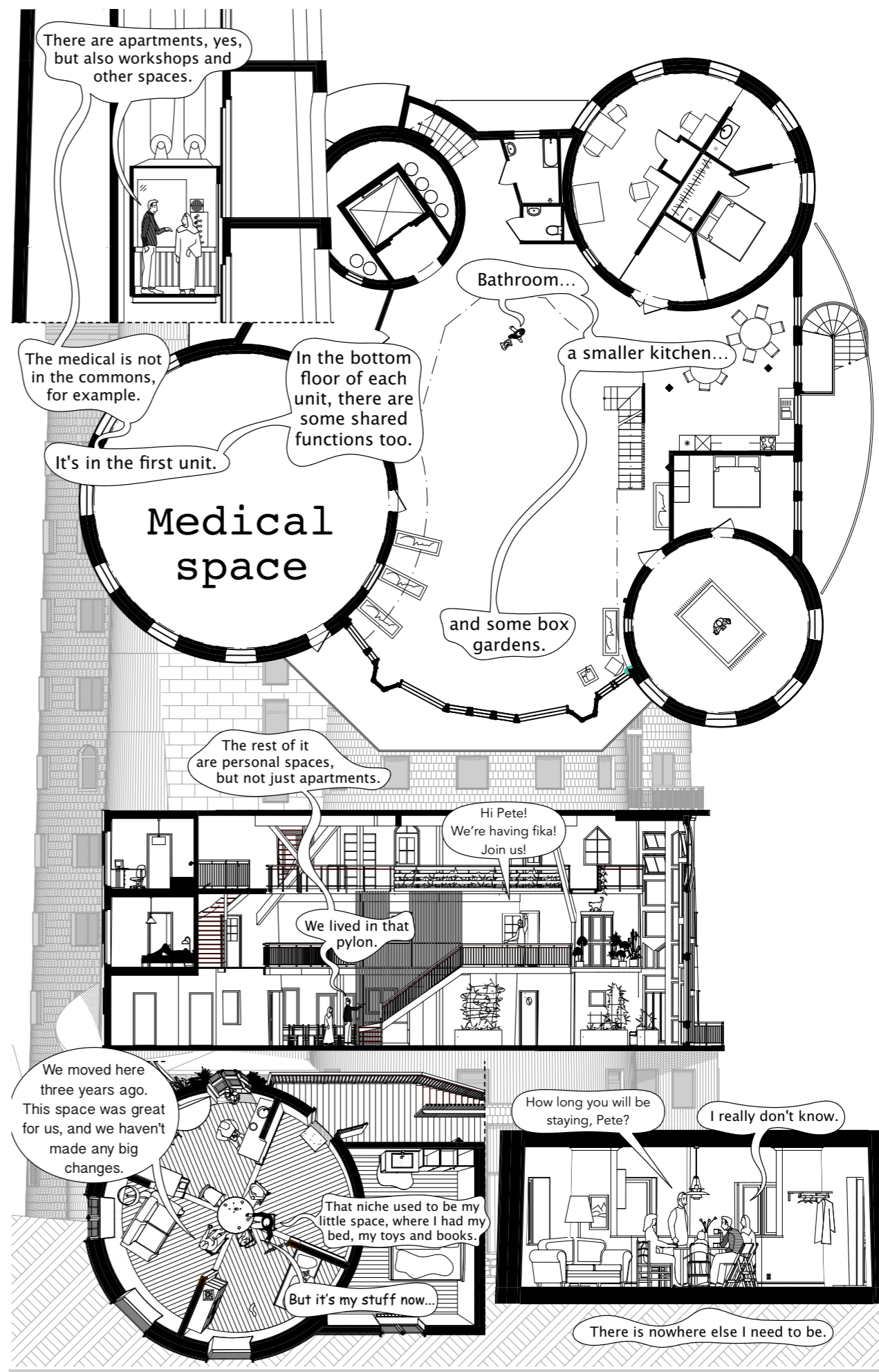

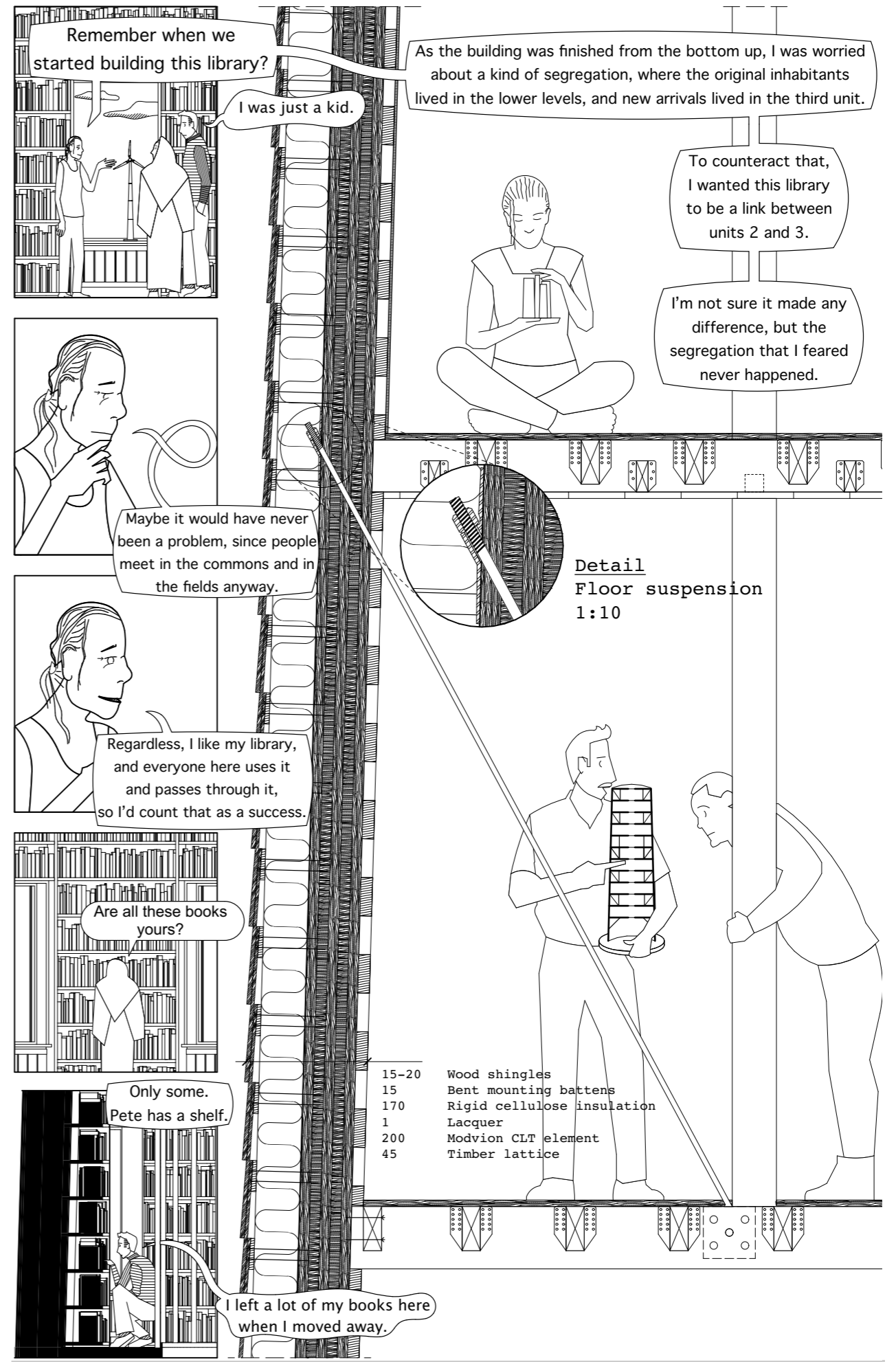
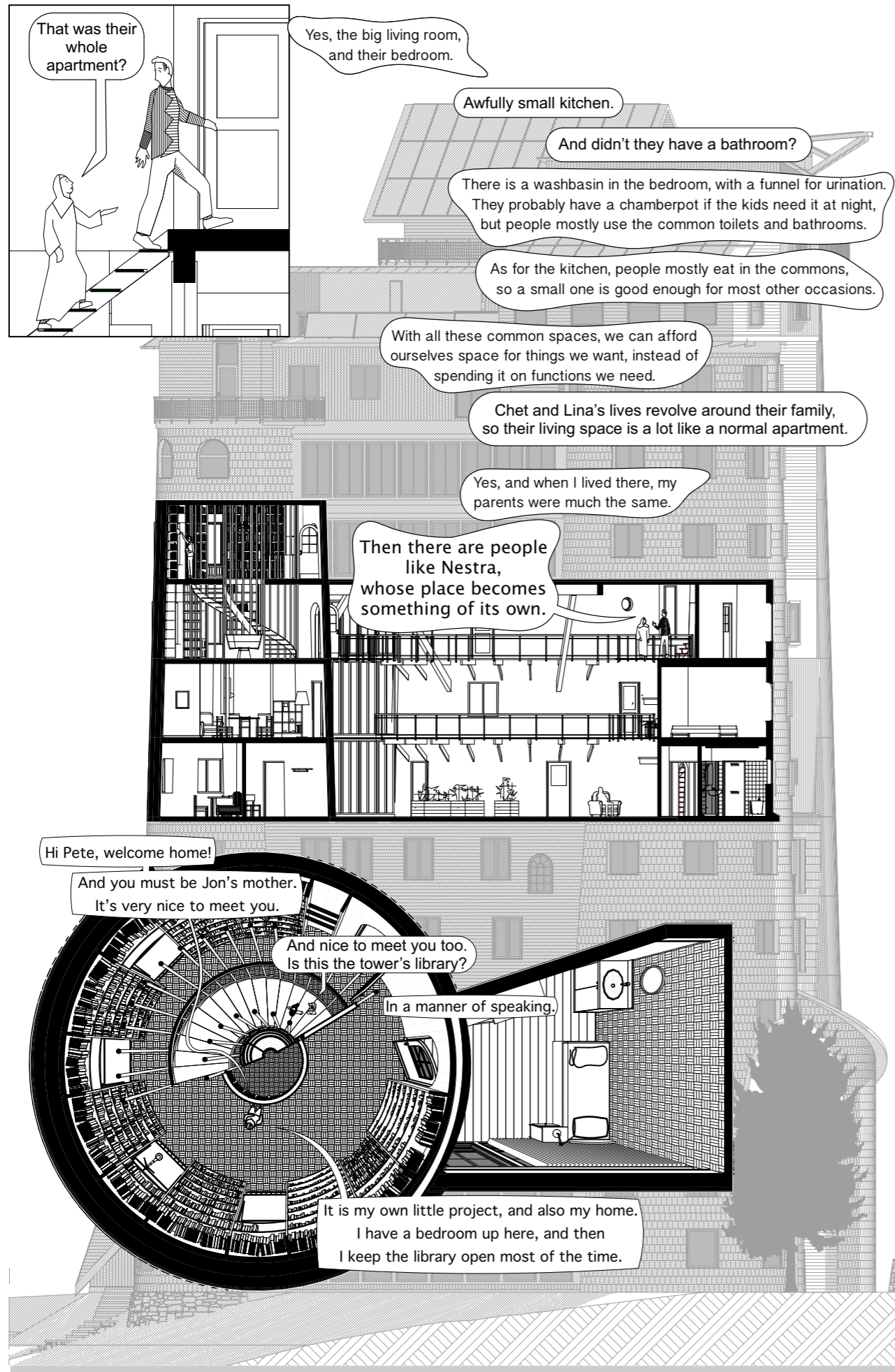

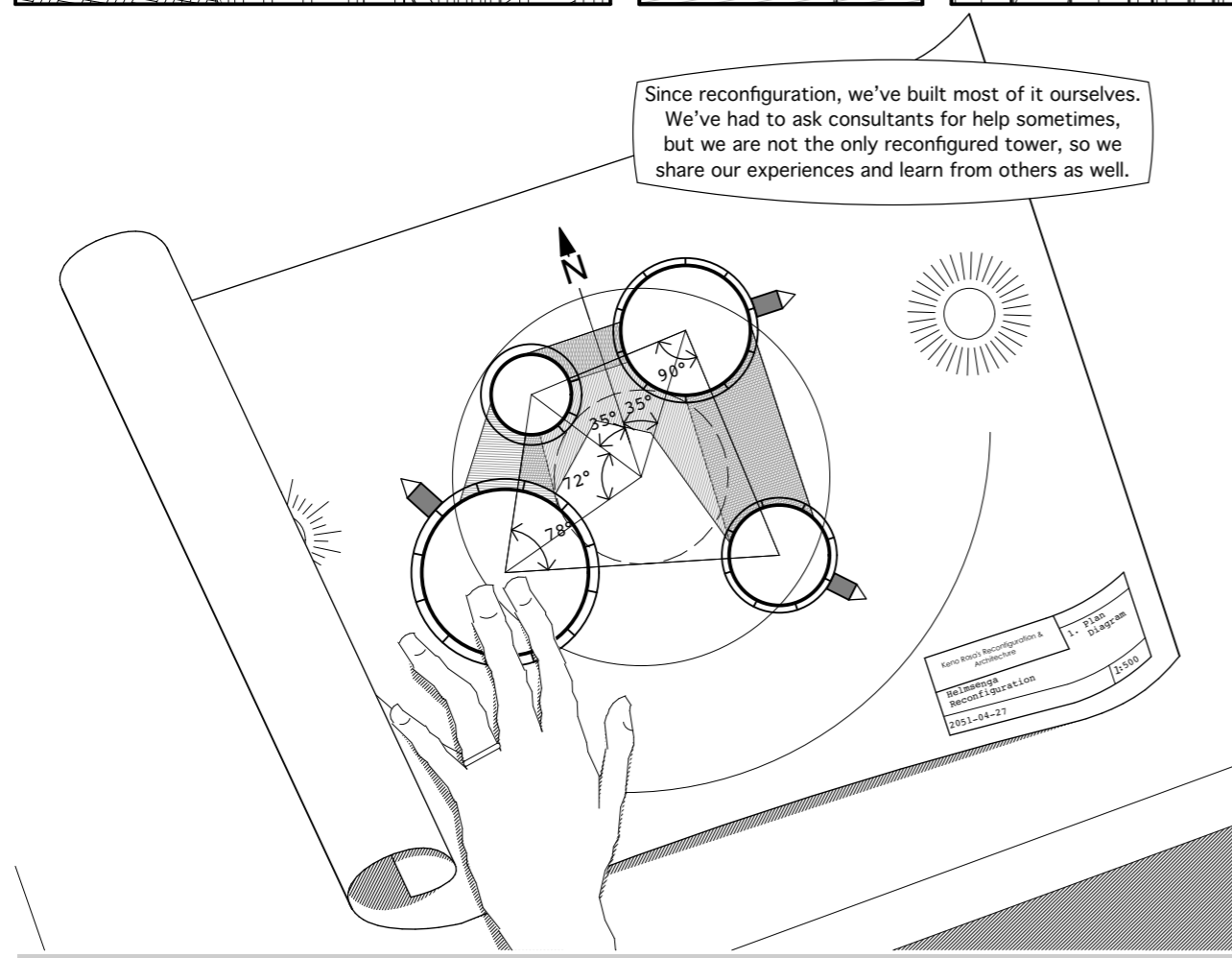

A hundred years ago, when wind power was starting to expand, all pylons were made out of steel. It worked very well for a while, but eventually, as the tower grew taller, engineers started to realise that steel was not the optimal choice.

You see, the pylon is subject to a range of forces, and as they grow taller they will start to buckle under lateral wind pressure. To counteract this, the material has to increase in thickness, and the pylon actually becomes stronger than necessary in certain respects.

Since an equally high pylon built out of timber would need to have a thicker shell anyway, the buckling issue is already dealt with. The 200 mm of timber simply isn't gonna buckle.

The rotors wear out and need to be recycled, but so do the towers themselves. After a few decades, material fatigue makes them unsafe, and they have to be taken out of commission before they fail. When the towers were all steel, this wasn't an issue. While recycling steel is resource intensive, it works well. The old tower is simply remade into new ones, or screws, tools... whatever is needed.

The timber towers could be burned, or cut up into sheets or studs for other uses. But when it comes to recycling and reusing, the less you need to process the material, the more efficient the process is. By reconfiguring the tower into several shorter pylons, they can support each other while being subject to less stress than the original tower. Eventually, when the technical lifetime of this reconfigured tower is over, the material is recycled and used as boards, sheets, and eventually burned for fuel. Hopefully the material will have been used for a few hundred years before then.

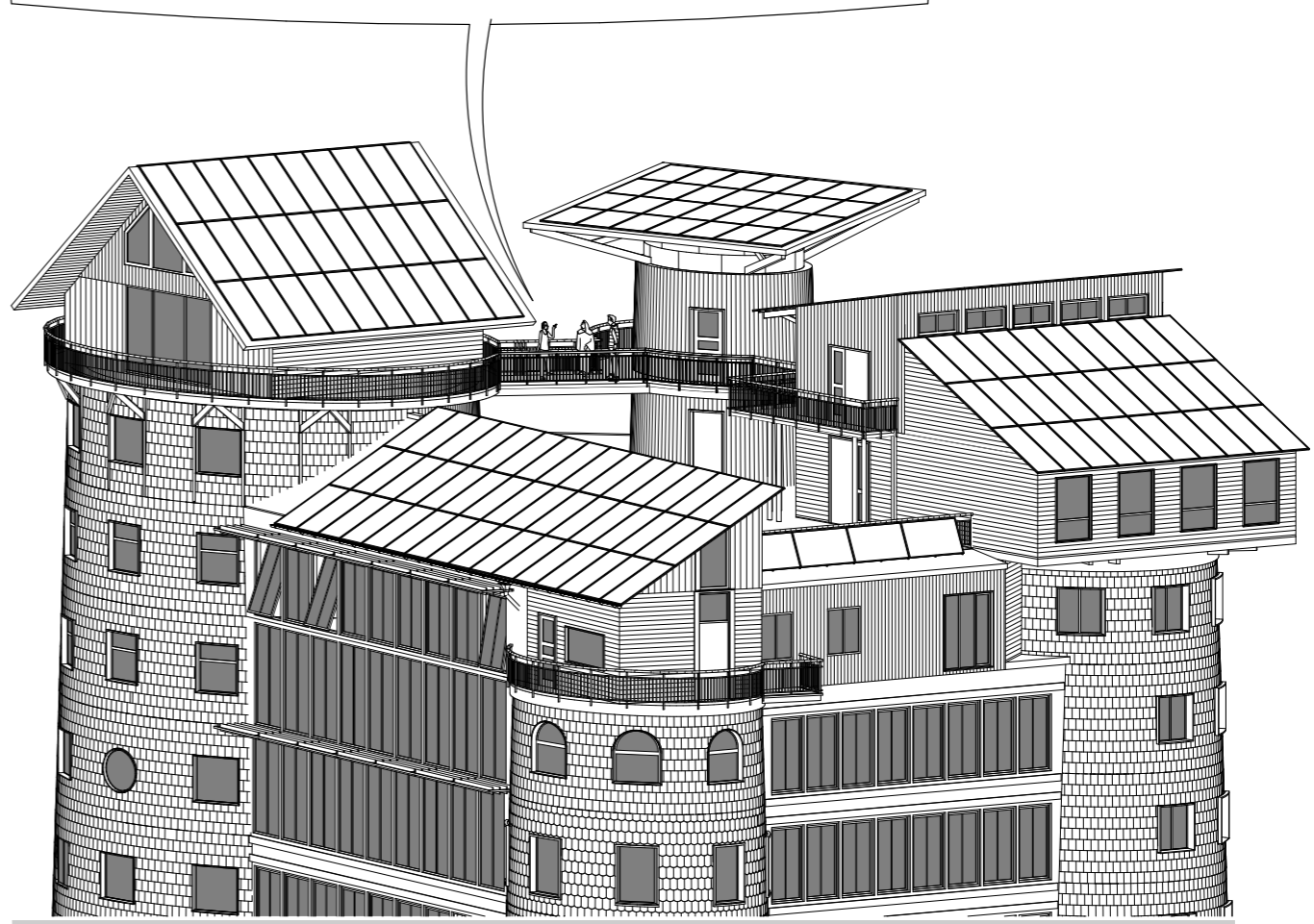
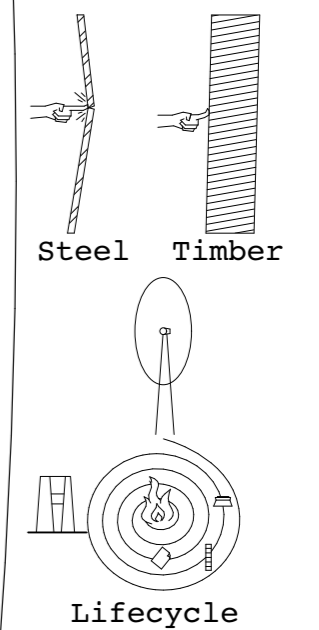
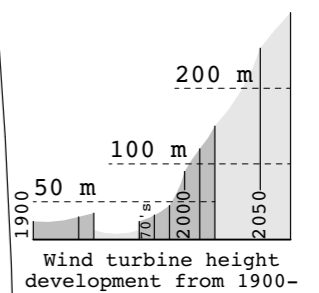

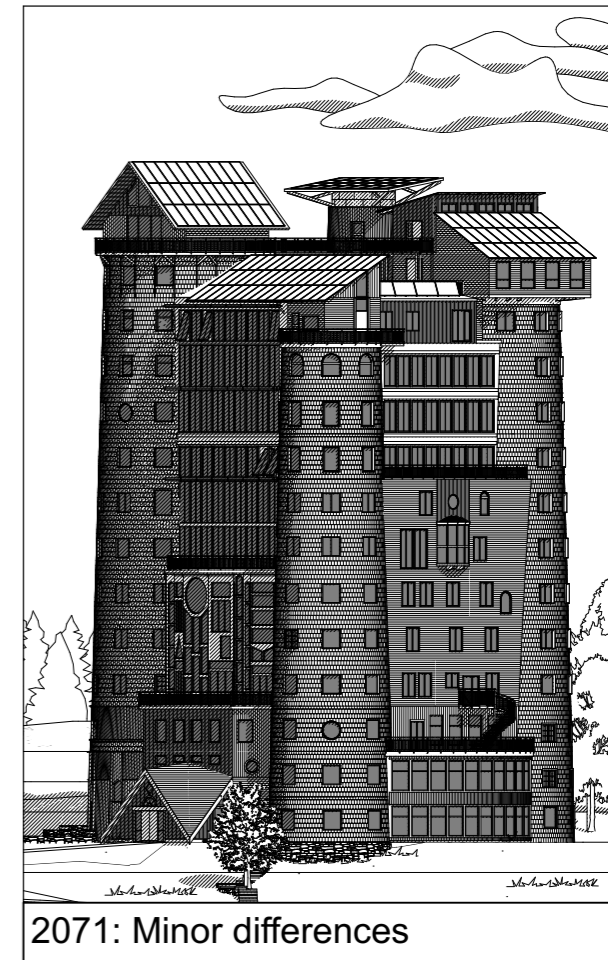
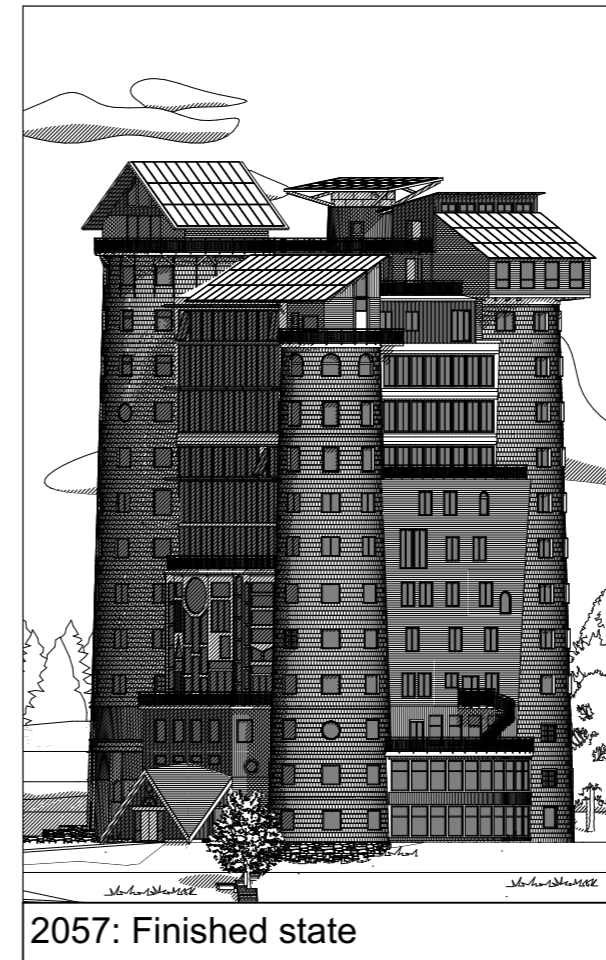
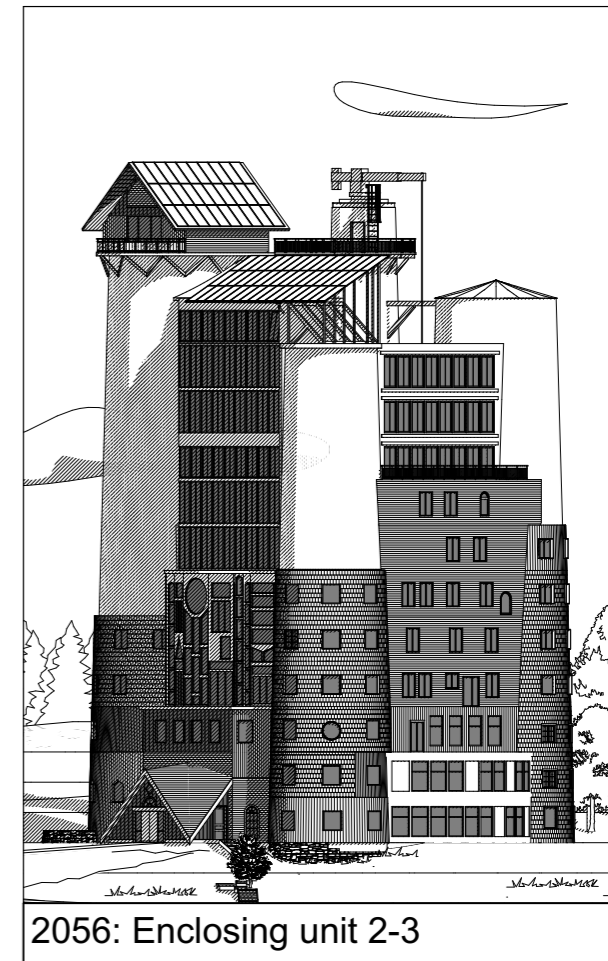
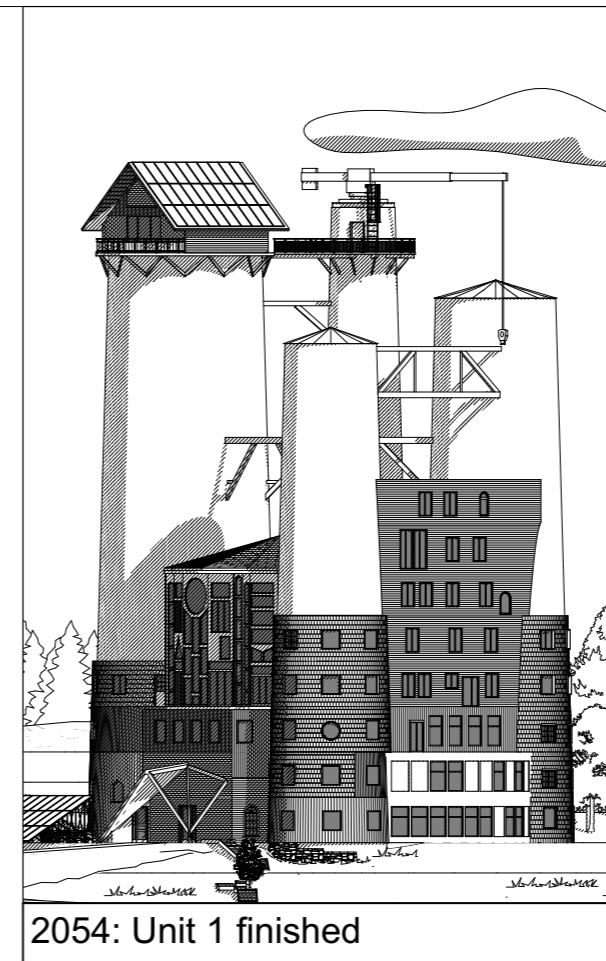
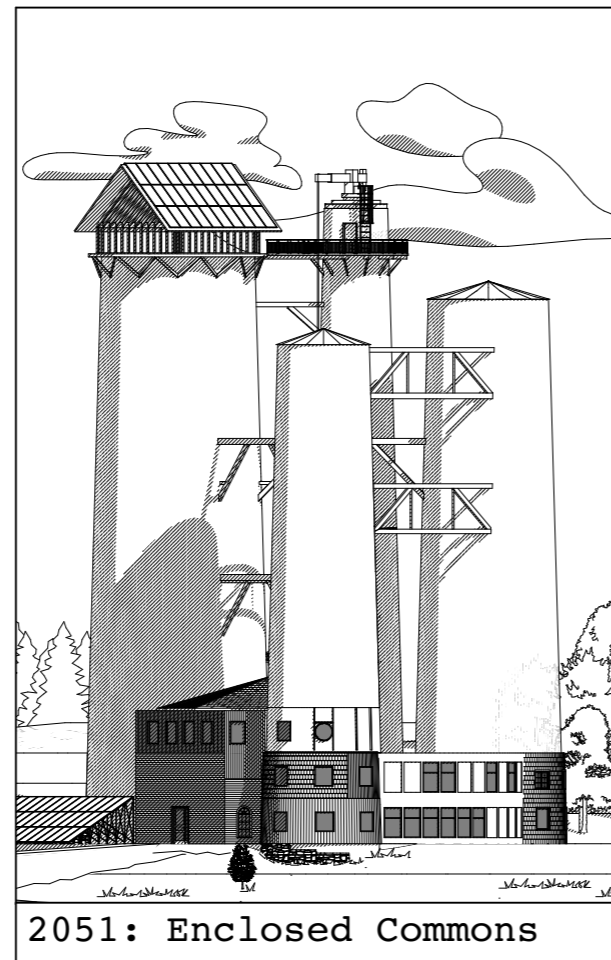
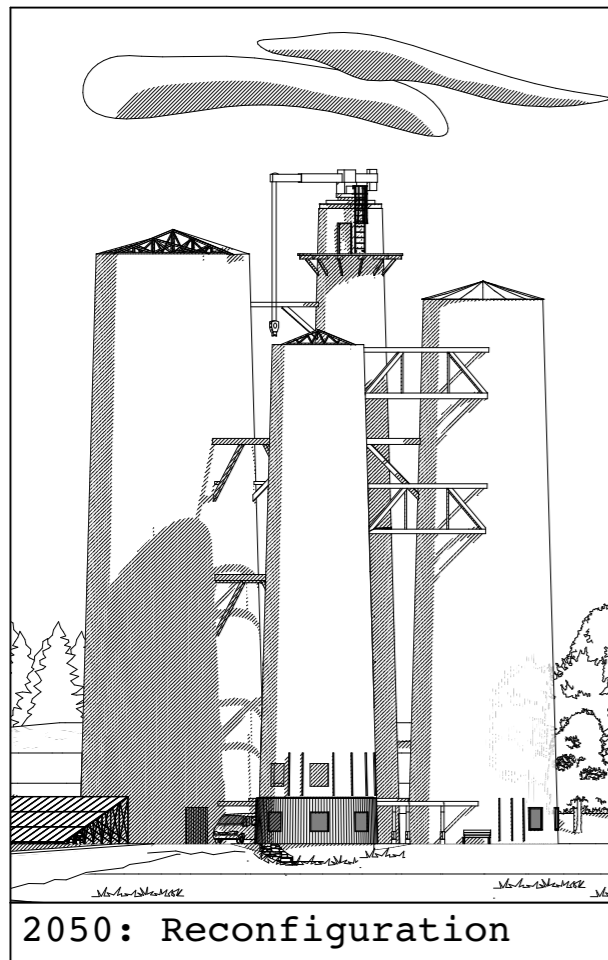
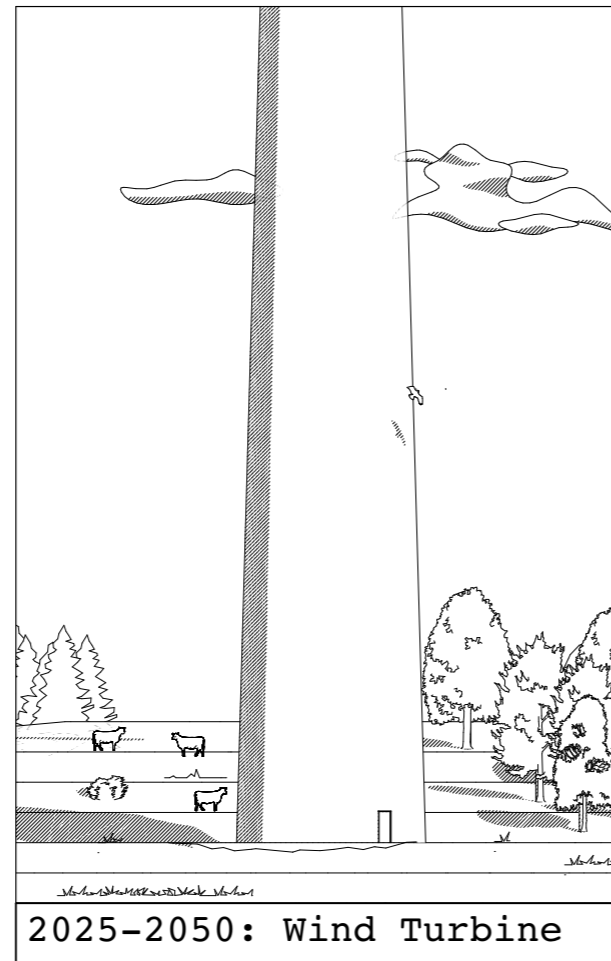
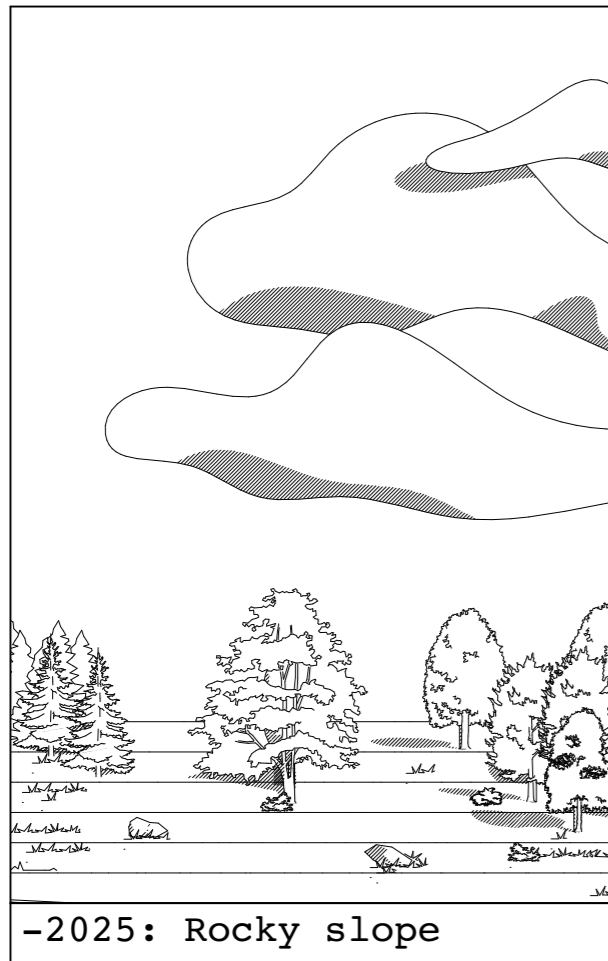



# PART 3

Part three begins with a few silent pages, detailing a day in the life of our protagonist, including agricultural work, household duties, social life and leisure.

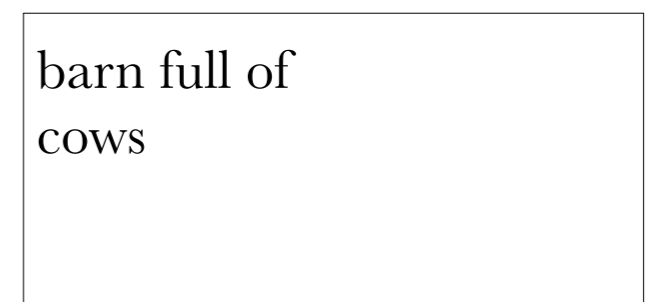
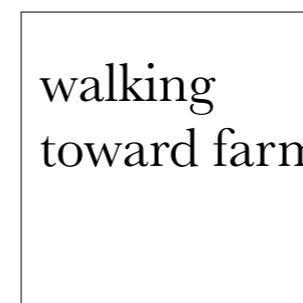
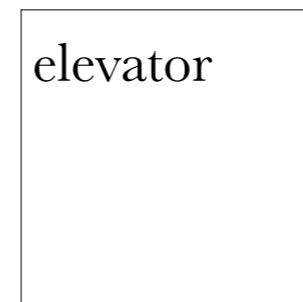
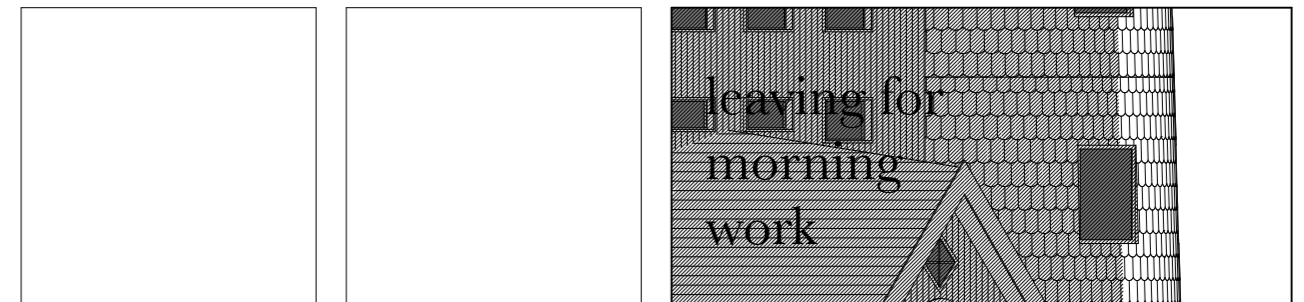
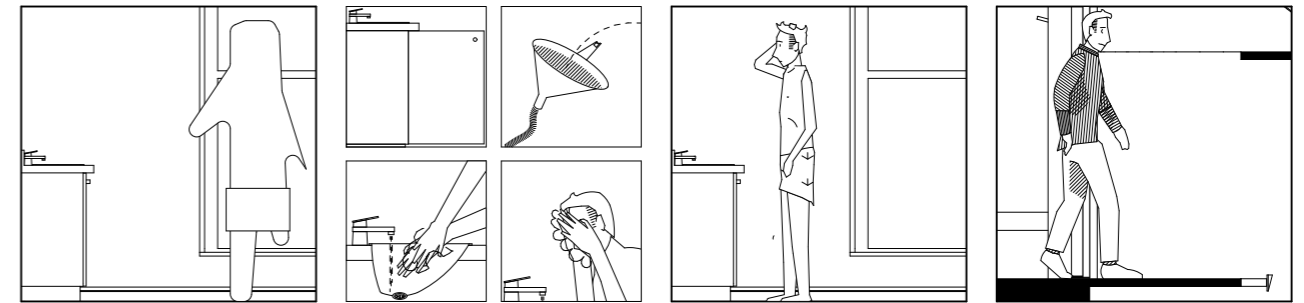
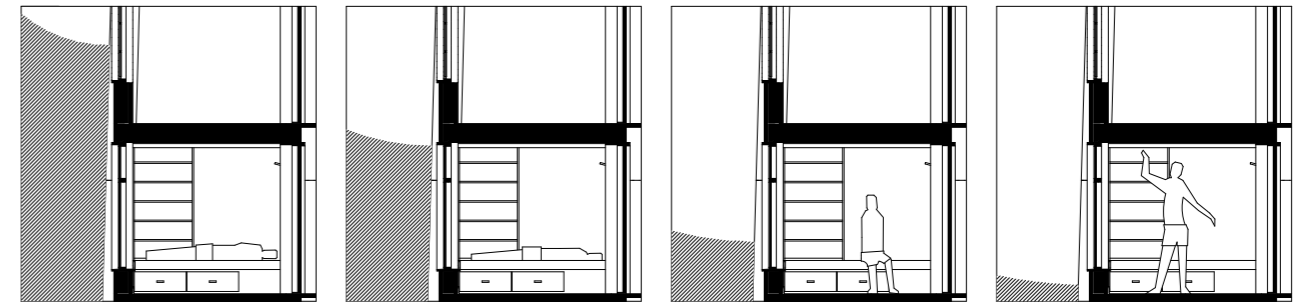
I have been working on the script for the rest of this part, and it contains more discussions about rural life and death and serves to bring closure to the narrative arcs of our cast of characters.

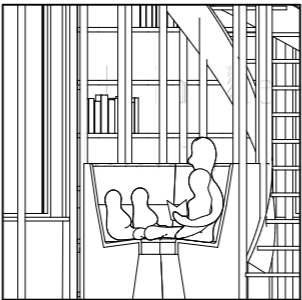

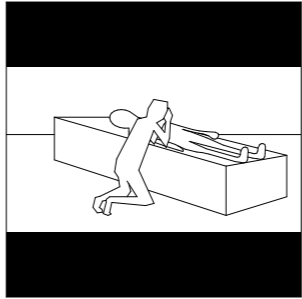
|                     |                 |  |          |
|---------------------|-----------------|--|----------|
|                     |                 | breakfast  |          |
| gardening           |                 | reading<br>question  |          |
| random meeting      |                 | fencing outdoors   |          |
| thank you           | Elevator        | Washing  |          |
| going to see Nestra |                 |  | reading  |
| schoolwork help     | leaving library | asking question  | Elevator |

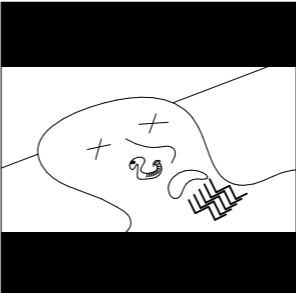
|   |   |   |  |
|---|---|---|--|
| getting lunch   | Lunch   |   |  |
| visit atelier   |   |   |  |
| VR sculpture  |   |   |  |
|   | night meal  |   |  |
| watching movies   |  |  |  |
|  | movie ended   |   |  |

# Summary & Result

**I find it immensely difficult to articulate, in my own words, what exactly it is that I have done during this project.**

Instead, I have let my characters speak, not of the project, but the world and the place that they inhabit. Hopefully, that should make the project easier to read and understand, just as it has made it easier to write.

While the design incorporates many important aspects of sustainable design, such as the pre-planned recycling of materials and passive solar design, my focus has laid on imagining the lives of the inhabitants and their process of inhabiting the structure.

My aim has not been to depict this future and community as utopian, but rather as a plausible vision of the future, where it is possible to lead good and dignified lives, while being a part of the struggle for a more just and sustainable society.

**The building design, as well as the graphic novella showcased in this thesis remains a work in progress, but my hope is that it illuminates a previously unimagined possibility for rural Sweden.**

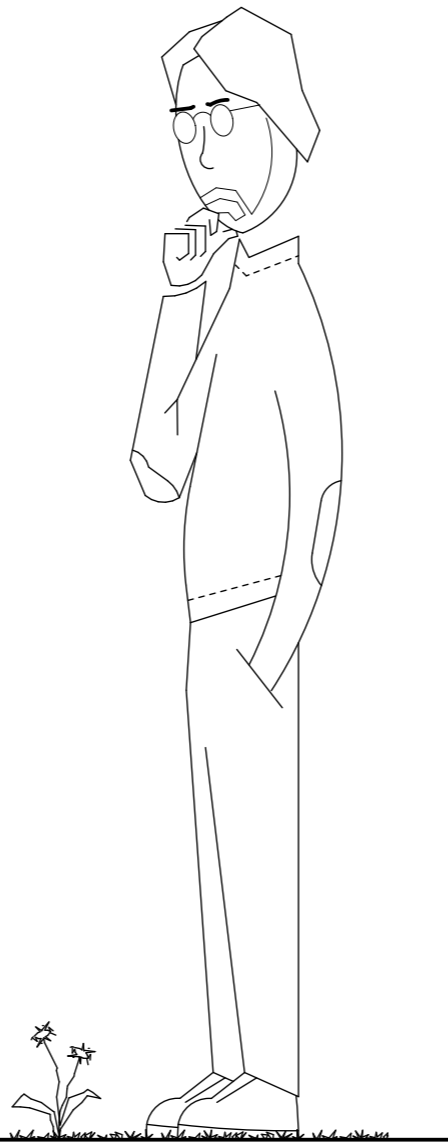

# Reflections

## The Meaning of Life

While trying to write this reflection on my work, I keep drifting toward the larger questions that are not answered in this thesis, but whose presence in the back of my mind have informed my progress at certain critical steps. I would hate to ramble on and on, and I do not think I can say it more succinctly than: what are the ingredients of a life well lived?

Soothing and meaningful activities, time and space for artistic and scientific exploration and learning. Friendship and family, caring for and teaching each other.

It may seem banal, but I think it is worth remembering that there must be a greater goal than exaltation, profit and even survival. As ethical humans, we must not lose sight of this. The pursuit of justice and the eradication of poverty are excellent goals, but surely we must have hopes beyond that.

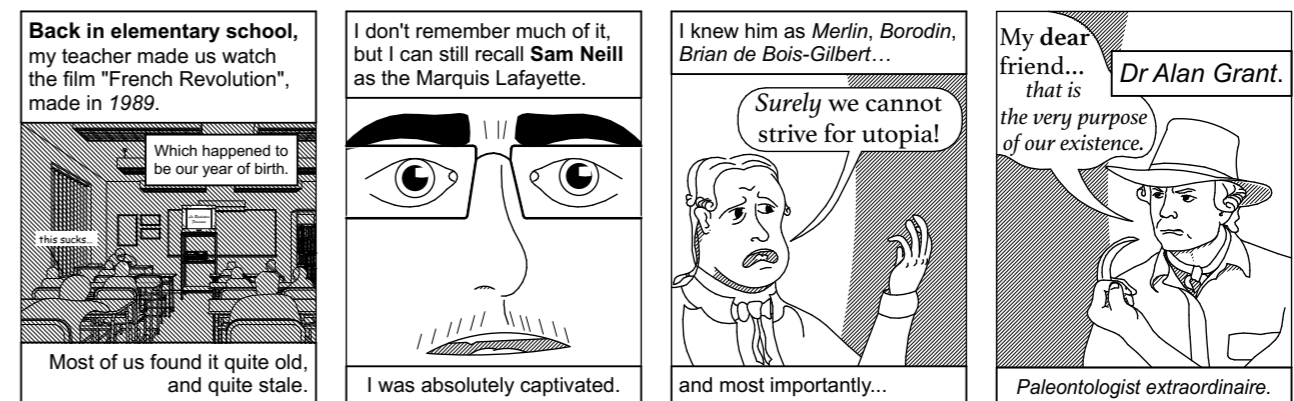

## The Influence of the Design Process

It is a certainty that one's method will affect the result. However, it is not always clear how certain obstacles actually become the originators of ideas that afterward seem absolutely integral and essential to the project, in spite of them not having been conceived at the start.

As an example, an important idea of the final design is the freedom given to the inhabitants to use their given space as they see fit. This freedom comes from a decision to make communal many of the basic function of an inhabitants private space: bathrooms and kitchens. While I always wanted to feature communal spaces in my design, the extent to which the design as presented does so, was not always my intent. Indeed, the early sketches which were not based on the reconfiguration of any specific structure, featured apartments and smaller communal spaces very similar to what is described in *Creating Co-housing* (McCamant & Durrett, 2011). Only when it became clear that any apartment based on current standards would hardly fit into a pylon, much less be an actually attractive living space, did I decide to reject the thought that the apartment as we know it is an absolute.

Similarly, the idea that the tower community should self-build most of the spaces is partly a result of the seemingly impossible task of finding good standard solutions for a building where every floor is unique due to the conical shape of the pylons.

No matter the extent to which these geneses are true, the resulting ideas (being the rejection of the standard apartment and self-building as lifestyle) have become philosophically integral to the project.

# The Influence of Comics on the Design

The melding of architectural drawing and comics usually means that the representational accuracy of the architectural drawing is compromised. As I did not want to do this, I found myself instead having to make compromises with the design itself. For example, the placement of bathrooms on floor 7 depended on how the main section showing that floor was drawn. The level of detailing and work put into the different areas of the building depended heavily on whether or not they featured prominently in any layouts (and indeed, certain layouts were also designed to exclude areas that I did not think warranted further detailing).

Since I consider the comic and the ideas expressed in it to be more important than the precise design, I do not consider it a problem. As previously expressed, the important parts of the design are certain principles, and my design choices are not necessarily the ideal expression of those principles, but rather an application of those principles in a manner that is suitable to the medium.

## “If this is such a great idea, why doesn't it already exist?”

Currently, most of the problems that this design would help solve are already solved - with fossil fuel (Günther, 2002). There is no urgent need for more domestic agricultural production, while importing most of our food remains economically viable. Perhaps the latest (current, as of writing) pandemic crisis will make the need for a higher degree of self-sufficiency obvious, in advance of the approaching crises.

Another factor is economic and technological in nature. The timber tower on which my design is based is still in development, and as is shown in the comic, the reuse of such a tower would only take place decades after its construction. Another basic idea of the project is that the reuse of the tower would be planned for ahead of its construction, which would affect their placement and how the foundation is made etc. While there are some large scale buildings that could be (and are) reused in a manner similar to what I am describing, these structures differ in two critical ways: the structure may lack adaptability because their reuse was not planned, and the land surrounding it is often polluted, a result of its original use as a factory.

A third factor is cultural. I am not sure that there exists a community that could successfully create a building such as what I have proposed. My hope is that people will find better ways to use the internet to share ideas and knowledge, and that the next generation will be more scientifically, technologically and ecologically literate than mine.

## Who profits?

According to my fictitious narrative, the particular building that I have designed was made possible by an investment from local farmers, who intended for it to be the home of a community that could inherit and work the lands surrounding it in the future. This is not a gesture of charity, but a real investment. The power generated in the 25 years prior to reconfiguration is used to work the land, and the future tower community will make it possible for the farmers to semi-retire and work as managers and consultant, rather than continued physical labour or retirement. I imagine the inhabitants of the tower as an anarchist communitarian group, who share the workload and the profits equally, while existing within a support network of similar communities in surrounding areas.

A building based on the same technical principles could of course be financed and governed in any number of ways: rented flats, hotel rooms or a more traditional housing cooperative. The resulting buildings would be quite different from the one I have proposed, which is something I intend to showcase as I keep working on the comic.

Since the same type of pylons will presumably be used in wind turbine parks where a reconfiguration as described in this booklet is not desirable, there would also be pylons that need to be moved before their material is reused. It is thus possible to imagine that buildings such as these would pop up in urban areas as well, or that a reconfigured tower might built using several pylons.

# Ruralisation

The Rural Microarcolgy differs from the admittedly sparsely detailed model for ruralised towns and their eco-units as presented by Folke Günther (2001). The tower community has the population of approximately 1/10 of an eco-unit group, and is placed within an existing, but sparsely populated, rural community. While this situation is not described in Günther's simplified scenario (which does not address how the eco-units relate to existing rural communities), I do not think it means that it contradicts it.

The groups of eco-unit in Günther's model look a lot like a small town similar in scale to the one I grew up in (the integration of agriculture being a big difference), and while such a town can certainly be nice, I think other alternatives are also needed. As of today, multi-family housing is exceedingly rare outside of urban areas, and I do not think it is because no one wants to live that way. To me there is something inherently attractive about a solitary tower surrounded by rural lands, and I do not think I am alone in thinking this. Regardless, the responsibility and freedom of owning a house should not necessarily be something that goes hand in hand with rural life.

The last decade has seen several technological developments that could also help make ruralisation more plausible. Self-driving vehicles, while having been theorized and part of speculative fiction for a hundred years or more, are now close to becoming a reality. A well designed car sharing system, in concert with self-driving technology, could make commuting to and from rural areas increasingly convenient and energy efficient. The current pandemic (as of writing, covid-19) has also necessitated a high degree of remote work and digitalisation, and there will have been great advances made in these areas, both social and technical. These combined factors will make it increasingly possible for people in most kinds of professions to live in rural areas.

## Individuals and their space

In Sweden today, the average living area of every individual is around 40 m<sup>2</sup>. Imagine what you could do with all that space if you did not have to have your own bathroom, kitchen and rarely used fancy dining room.

In my design I have made the assumption that the presence of common functions would not mean that the individuals space would necessarily be smaller (something that is common in co-living situations), but rather used for different functions than a normal home would be. The sharing of these functions would give the residents a large range of spaces and possible activities to enjoy. The main example presented is the library of Nestra, but I have also imagined and started designing weaving studios, game rooms and others.

## Architects: The future of the profession

It is not with any intention to disparage my education that I say that much of what I have learned are things that ought to be common knowledge. I am not uniquely qualified to understand and express in architecture the needs of any one person.

Today, the architects work consists of finding good solutions that work for a multitude of people and conform to whatever the current set of standards demand. This is certainly a fine and challenging task, but my objection is that it is fundamentally based upon the production of living spaces as a profitable business, and not the opportunity for learning and experience that it ought to be. I wonder how much more my grandfather values his home because he built it himself? As construction is one of the main activities that contribute to the depletion of resources and destruction of the natural environment, it ought not be done without pleasure.

With these ideas in mind, I thought of the architect in my narrative as one who supplies ideas and opportunities, rather than solutions. Certain aspects of the processes clearly need to be overseen by an educated eye, but many other could certainly be tackled by amateurs\*.

\*Amateur, in its original meaning, being one who pursues an activity for the love of it, and not necessarily without expertise or skill.

# References

## Theoretical background

Günther, F. (2002). *Making western agriculture more sustainable*. *Feasta Review*, 1. Retrieved from URL <http://www.feasta.org/documents/feastareview/guenther.htm>

Günther, F. (2001). *Ruralisation - integrating settlements and agriculture to provide sustainability*. Retrieved from [http://holon.se/folke/lectures/Ruralisation-filer/v3\\_document.htm](http://holon.se/folke/lectures/Ruralisation-filer/v3_document.htm)

Hagbert, P. (2018). *Framtider bortom BNP-tillväxt: slutrapport från forskningsprogrammet "Bortom BNP-tillväxt: scenarier för hållbart samhällsbyggande"*. [Stockholm]: KTH Skolan för arkitektur och samhällsbyggnad.

Hopkins, R. (2008). *The Transition Handbook: From oil dependency to resilience*. United Kingdom: Green Books Ltd.

Long, C. (2000). *The House as Path and Place: Spatial Planning in Josef Frank's Villa Beer, 1928-1930*. *Journal of the Society of Architectural Historians*, 59 (4), 478-5091. Retrieved from <https://www.jstor.org/stable/991622>

McCamant, K., Durrett, C. (2011). *Creating Co-housing: Building Sustainable Communities*. Canada: New Society Publishers.

Pinder, D. (2002). *In defence of Utopian Urbanism: Imagining Cities after the 'End of Utopia'* *Geografiska Annaler. Series B, Human Geography*, Vol. 84, No. 3/4, pp229-241. United Kingdom: Taylor & Francis Ltd.

Wallnér, E. (Host & Producer). (2018, 20 november). *Erik Dölerud. Om att bygga 150 meter höga vindkraftverkstorn - av trä*[Podcast]. Retrieved from <https://solcellskollen.se/podcast/erik-dolerud-om-att-bygga-150-meter-hoga-vindkraftstorn-av-tra?fbclid=IwAR33L0pVR5MeiEjHrOncVgdt1lvJPR0PKy16t3wQD9PtwZOnnHDb9TqdZ5Y>

WDCD. (retrieved 2019-01-29). *Microarcologies as a model for sustainable co-living*. Retrieved from <https://challenge.whatdesigncando.com/projects/micro-arcologies-as-a-model-for-sustainable-co-living/>

## Comics references

Groensteen, T. (2013). *Comics and narration*. Jackson: University Press of Mississippi.

Mazzucchelli, D. (2009). *Asterios Polyp*. (1st ed.) New York: Pantheon Books.

McCloud, S. (1994). *Understanding comics: the invisible art*. New York: HarperCollins Publishers.

McCloud, S. (2006). *Making comics: storytelling secrets of comics, manga and graphic novels*. (1st ed.) New York: Harper.

McKean, D. (1990). *Dave McKean's cages*. Oregon, USA: Dark Horse Books.

Tsukamoto, Y. & Kaijima, M. (2014). *Graphic anatomy 2 Atelier Bow-Wow*. Tokyo: Toto.

Ware, C. (2012). *Building stories*. New York: Pantheon Books.

