

Skeppsbron Brewery

Spatial synthesis of architectural tectonics

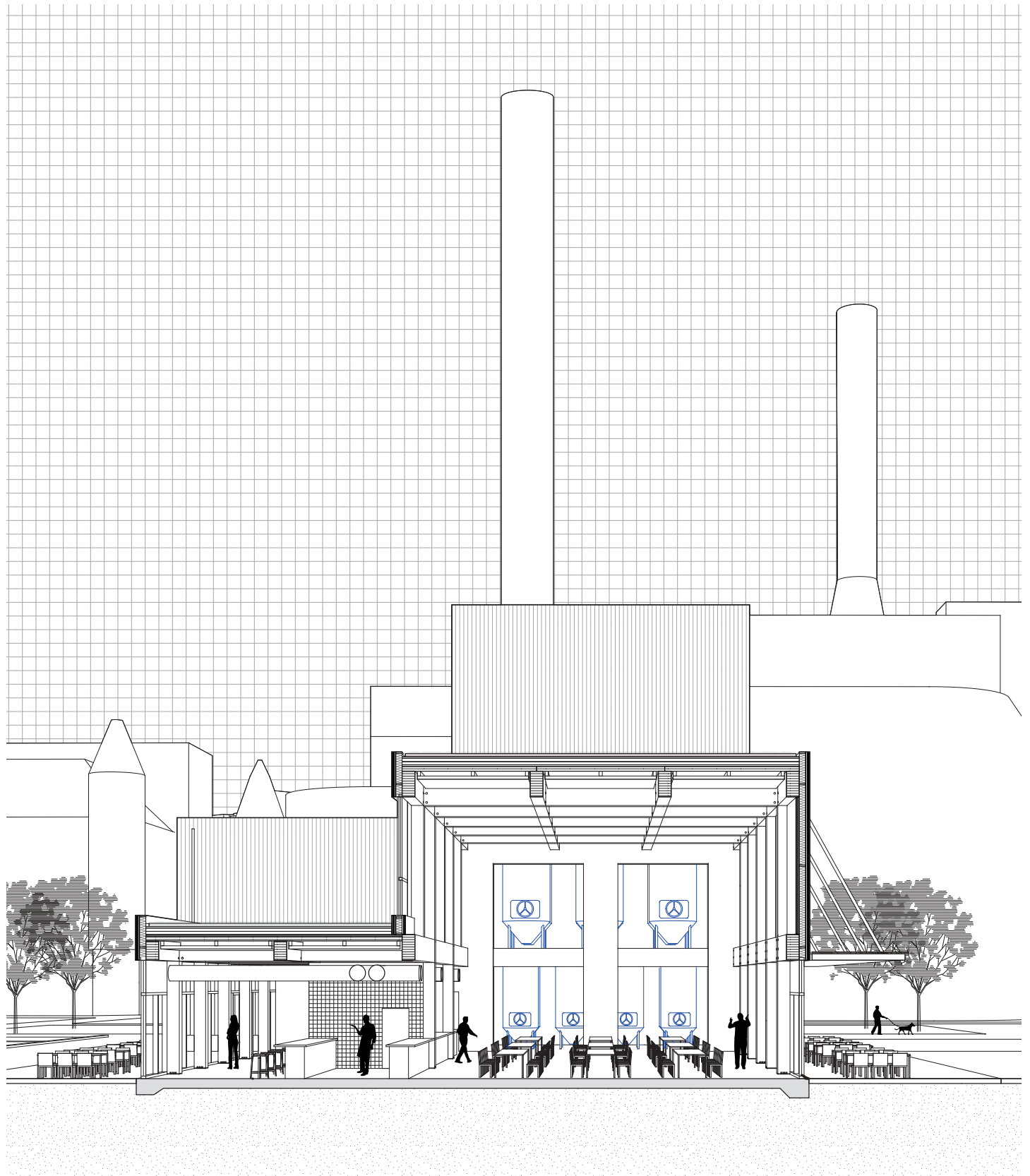

Alexander Svensson

Spring 2023 | Master Thesis

Supervisor: Filip Rem

Examiner: Björn Gross

Chalmers School of Architecture

Department for Architecture and Civil Engineering

Master Thesis in Architecture
Spring 2023

Skeppsbron Brewery
Spatial synthesis of architectural tectonics

Author: Alexander Svensson

Chalmers School of Architecture
Department for Architecture and Civil Engineering
MPARC Architecture and Urban Design

Supervisor: Filip Rem
Examiner: Björn Gross



Abstract

This master thesis is exploring the relationship between spatial experience and architectural tectonics. Working with the building's tectonics as the performing medium in the design of a brewery and restaurant at Skeppsbron, Gothenburg. Deriving from the theory of architectural tectonics, the thesis aims to articulate the character of the stereotomic and tectonic, incorporating the essence of both structures as design tools to achieve a spatial experience that supports the given parameters of the building's functions as both an industrial facility in combination with a public venue. Resulting in a building that highlights the duality of spatial qualities, as well through contrast brings them together and creates a robust design, that is grounded on site and reflects the heritage of Skeppsbron and Gothenburg as a whole.

The method involves a study of the notion of architectural tectonics where the distinction made by Gottfried Semper in 'Four Elements of Architecture' creates a starting point. The definition of the hearth, earthwork, framework, and enclosure, with its inherent structures and attributes, develops a toolbox for design which revolves around the massive, light, and enclosing principles. Through analyzing the site, and the current transformation of Skeppsbron into a new public venue in the city, where housing and retail is planned together with a new quay edge and public bath the historical context of the site is emphasized.

With its long history as harbor and industrial character the site allow for a public and industrial building, where a brewery and restaurant become central, deriving from the precedent of a brewery at Skeppsbron in the 1800s as well as linking to the brewing industry in Gothenburg. Offering an open public program together with an industrial engine, the program is architecturally reflected through the tectonic character of each function. The public as a light framework structure and the brewery as stereotomic, focused space - gathered under an enclosing membrane. Highlighting the assemblage of the building and the duality of experience. Ultimately demonstrating how the tectonics of the building can be utilized to reflect both the architectural experience as well as the cultural heritage of the site.

Keywords

Skeppsbron, brewery, architectural tectonics, Four elements of architecture

Contents

Part 1 - Introduction	10
1.1 Background	12
1.2 Theoretic Framework	14
1.3 References	26
Part 2 - Context	28
2.1 Site	30
2.2 Analysis	36
2.3 Program	38
Part 3 - Building	44
Discussion	82
Bibliography	84

Student Background - Alexander Svensson

Chalmers University of Technology

MPARC Architecture and Urban Design 2020-2023

Matter space structure 3

Master thesis preparation course 1 & 2

From concept to existing building

Material and detail

Sustainable development and the design professions

Bachelor of Science 2016-2019

Aarhus School of Architecture

Erasmus exchange spring 2021

Building culture and tectonics

Critical written reflection

Internships

Henning Larsen, Copenhagen 2021-2022

Rstudio for Architecture, Gothenburg spring 2020

Tyréns, Gothenburg fall 2019

Born in Linköping 1997

Part 1 - Introduction

1.1 Background

Thesis aim

The aim with this thesis is to investigate the notion of tectonics and spatial experience by designing a brewery and restaurant at Skeppsbron, Gothenburg. Deriving from an interest in the material and spatial experience, the aim is to bring two sets of program together and represent the essence of each function tectonically. Investigating how construction, material and distribution of space all frames the envelope of architecture; from the tactility of surfaces, openings, light, scale and construction. Ultimately how architectural elements, and especially the tectonic assemblage shape the performance of the building and how we perceive space.

In this context architectural tectonics thereby becomes an important notion how the assemblages and representation of architecture is articulating and regulating the experience of space. Tectonics, from the greek tekton, describes the transition from space to built reality - uncovering the intersection between the regulating and enacting performance of architecture. What can be represented through space ultimately also is represented through the tectonics and the assemblage of architecture.

The result is a building that is designed with a conscious design framework derived from the notions of tectonic and stereotomic. What the tectonics perform, is it perceived as light and heavy, open, closed, public private etc. Bringing that together in a design, working with a duality that create an interesting contrast, while supporting the spatiality which ultimately grounds the architecture and secures a robustness over time.

Research Question

How can a building for a brewery and restaurant be designed at Skeppsbron, expressing the spatial experience of its function and character, through the tectonic assemblage of the building?

Methodology

The method involves a theoretic study of the notion of architectural tectonics to understand the basic notion of stereotomics and tectonics to develop a design concept. Four Elements of Architecture by Gottfried Semper plays a central role in this study. Highlighting the essence of the hearth, earthwork, framework and enclosure the method seek to build a toolbox, acting as precedent for the tectonic notion to be developed into a design proposal. Moreover, by investigating the notions of spatial experience and architectural tectonics an understanding of the theoretical background is developed.

Thereafter the site is analyzed through an historic overview, understanding the development and key eras, buildings events on site to understand the essence of the site. A conversation was initiated with Älvstranden, to relate the project in the actual events of the process of development that sets a perspective of practice in the work.

By studying both built references of tectonic articulation as well as breweries, a construction and material palette is developed as well as a space program.

Delimitations

The thesis focuses on the definition on architectural tectonics that has been central in the development of the notion. By focusing on Semper, other parts of the notion might be overlooked. Experience of light/heavy is not universal nor black/white, it is a gradient. The thesis tries to underpin/exemplify an architectural language through the design, not determine exactly what is light/heavy, stereotomic/tectonic.

Moreover the thesis is not trying to develop the most detailed program, the scheme is merely diagrammatic to be able to showcase a spatial articulation that links the program and the tectonics. To design a fully operational brewery and restaurant therefore is another type of thesis topic to be conducted.

The thesis is neither supporting nor criticizing the development plan. Just using it as showcasing possibilities.

1.2 Theoretic Framework

In the book "Genius Loci" (1980), Christian Norberg-Schulz investigated psychological connotations in architecture, perception and symbolization. Although mainly focusing on the relationship between human and the surrounding environment, key notions of interest are highlighted throughout his writing.

Referring to the philosopher Heidegger, in seeking a purpose of architecture, the notion of "dwelling" appear, which can be described as the ability to settle. Norberg-Schulz claims this means that when a careful consideration of orientation and identification man dwells and life occurs on defined places. Staying aware to the fact that Norberg-Schulz focus on the aspect of the surrounding environment and the search of Genius Loci, the meaning of the place, the important aspect of orientation and identification still can be emphasized.

Linking to place and environment Norberg-Schulz (1980, 21) talks about the properties of identity as a concrete relationship. Developed from childhood, for example the Nordic environment impose a special relationship between human and weather; the cold, wind, rain, longing for sun etc. while another environment conversely impose another relationship to the same or a non-existing one - creating a multitude of local and cultural references. However, the mechanisms of identification remain universal. Where the essential acquaintances we make in our surrounding sets a base for identification and sense of dwelling.

In the book "Thinking Architecture" (2011), Peter Zumthor writes about how experience and memories are connected with the role as an architect. When contemplating about architecture certain images or connotations may appear, both related to the trained and professional knowledge that architects have learned during training and practicing but more importantly also memories connected to what might have been experienced in a more passive role, during childhood, living etc. Which arguable establish a clear toolset of elements or experiences that architects implement in its synthesis of building. Different relations, spaces and atmospheres linked to experiences. Moreover, Norberg-Schulz (1980, 22) ascertained that man is gathering "experienced meanings to create for himself an imago mundi or microcosmos which concretizes his world".

Juhani Pallasma (2005, 11-12) also advocates that architecture express an experience of our surrounding, which ultimately strengthen our presence and place in the real world. In this, architecture as in art "relates, mediates and projects meanings" speaking to our inner emotions through space, creating asso-

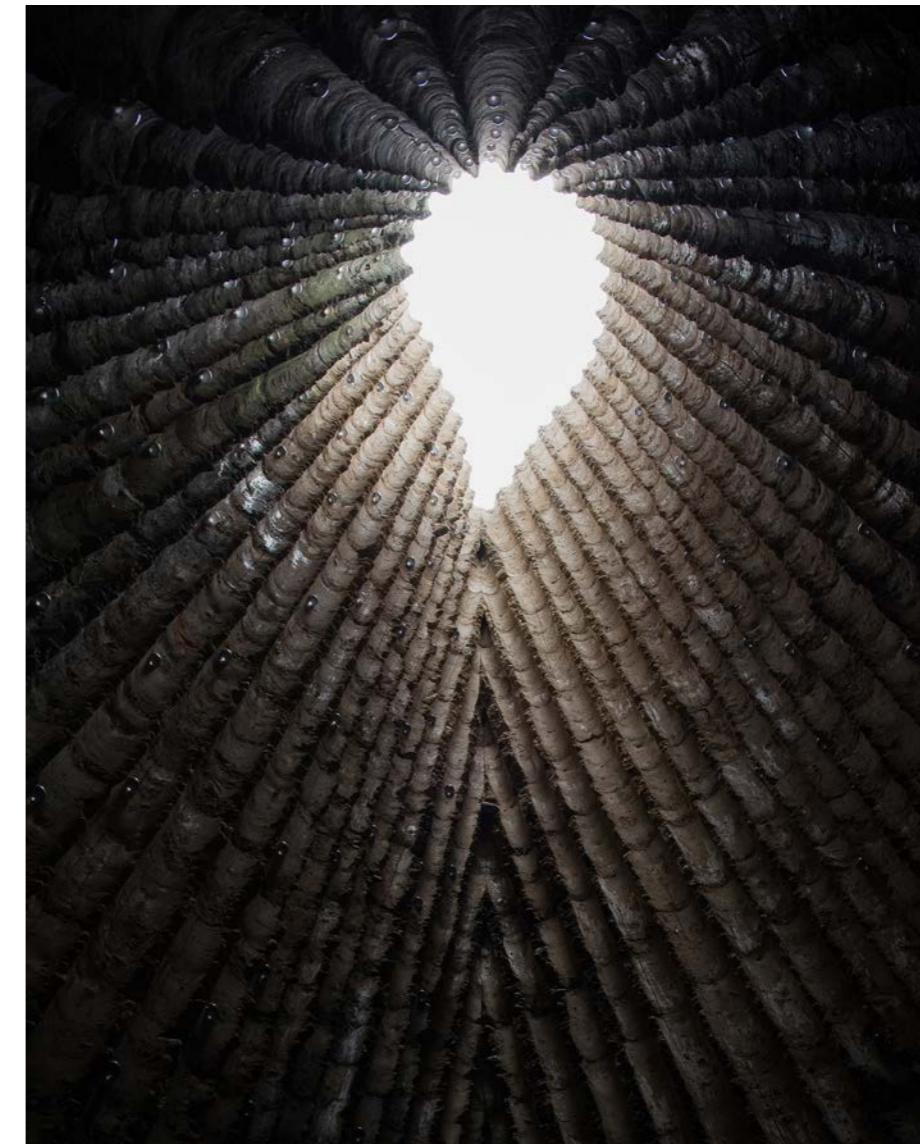

Figure 1.1: Bruder Klaus Chapel [Flemming Ibsen]

ciations. Norberg-Schulz (1980, 14) for example highlighted that behavior and function requires space with different character - dwelling; protective, office; practical, ball-room; festive.

On the topic of association, Sam Jacobs (2012, 11-15) discusses the representational aspect of architecture - enactment. Jacobs emphasizes how the idea that architecture, in its act of realizing an imaginary vision, works at the threshold between reality and fiction. And through the realization particular ideas and behavior are informed. Being both an idea, and concrete. Architectural priorities and organization establishes embodied forces that becomes a mirror of societal mechanisms.

"It not only represents and illustrates this fictional history but physically embodies it, playing it out through substance, space and programme."
(Jacobs 2012, 6)

Enacting architecture Jacobs defines as a duality of the theatrical and legislative form of the built. Architecture being both performative and binding in its form. Gestures that enables, permits, prevents and prohibits which shapes our understanding and behavior. Norberg-Schulz (1980, 18) again referring to Heidegger, exemplifies this through the concept of the bridge. Where the structure itself becomes a symbol or representation of the physical performance - connecting the two banks. Furthermore the structure impose a sense of oppositeness to the banks that now become oppose each other, uncovering and visualizing the embedded meaning of the landscape. Ultimately architecture itself through its enacting and performing nature becomes a representation of that envisioned idea or narrative that was conceived by the architect.

Finally, Zumthor and Pallasma mention the body of architecture. Zumthor (2011, 11) talks about the use of material, believing that the building stones itself generally has no embedded meaning but through the work of architecture a sense of poetry can be achieved in its assemblage. And through the act of constructing or assembling, the envisioned architecture and experience thereby become real - where it belongs and exist. Pallasma also stresses how architecture is relating to the human body. The way we interact with the built environment. Therefore the tectonic expression of a building is legitimatizing the architectural experience (Pallasma 2005, 64).

Space and tectonics

Kenneth Frampton with the writing: "Studies in Tectonic Culture: the poetics of construction in nineteenth and twentieth century architecture" seek to highlight, the potential of architectural tectonics in relation to the experience of architectural form and ultimately perceived space (Frampton 1995, 1-2).

Furthermore Chad Schwartz (2017, 65) reflects on how initial tectonic theory relating, through after the development of phenomenology. Schwartz refers to Pallasma and the perception of architecture as a full bodily experience, highlighting that the notion of tectonics has developed from a mere visual understanding of the assemblage to also involve the occupants experience of the built. Yet the visual understanding remains central to the understanding.

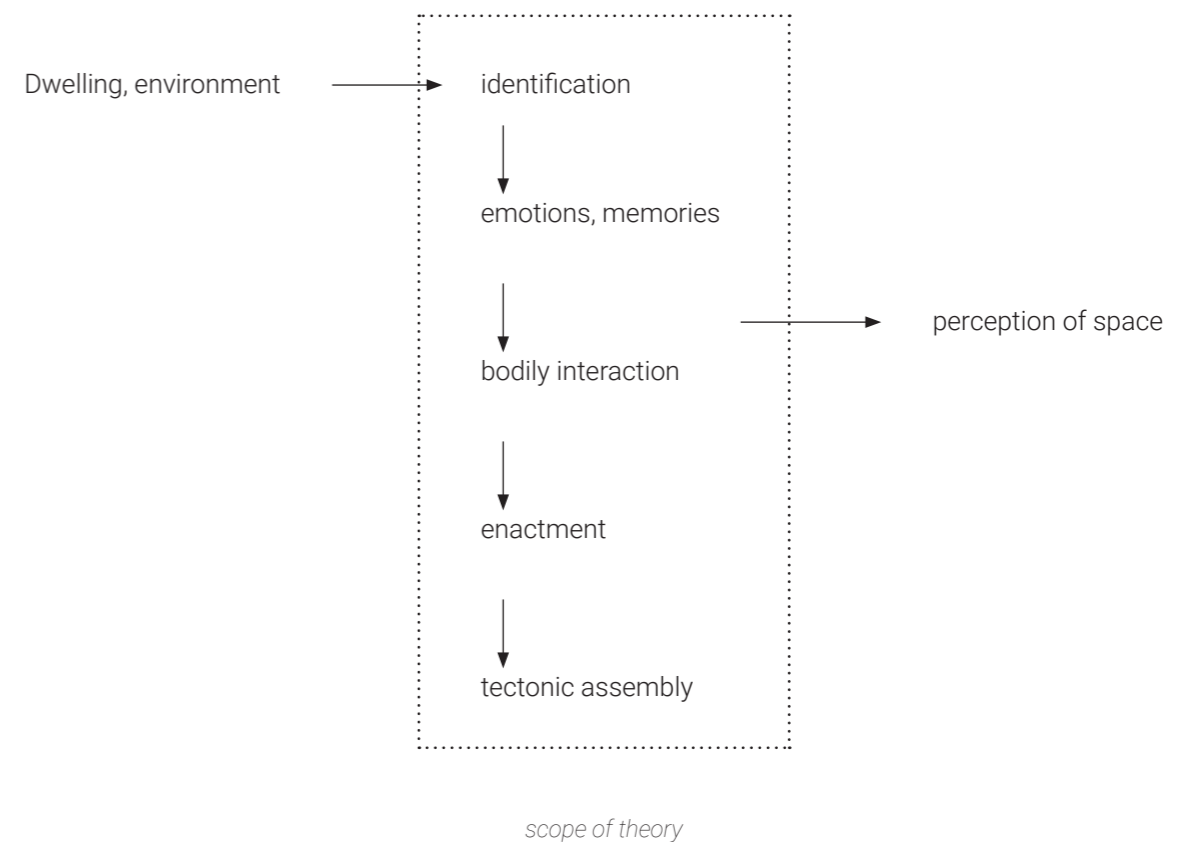

Architectural Tectonics

Chad Schwartz compiles in his text "Introducing: Architectural tectonics" an overview of the development of the notion of tectonics in architecture. Originating from Greek, tectonics is formed by the words 'techne' and 'tekton'. Tekton originally translating into carpenter that evolved into the architekton and the 'master builder'. 'Techne' meaning achieving something motivated by a set goal with the necessary knowledge conduct it (Schwartz 2017, 28).

Overall, the notion of tectonics comprises the threshold between fictional space and concrete realization through construction and material - emphasizing the holistic approach to architecture, "Architectural tectonics seeks a relationship between the design of space and the reality of the construction that is necessary for it to exist" (Schwartz 2017, 28).

Semper's four elements of architecture

Gottfried Semper, born in Hamburg on November 30, 1803, was a German architect, historian and theorist. In the late 1820s Semper was educated in Paris, where he thereafter conducted archaeological travels to Italy and Greece. In 1834 he was appointed as professor at the Dresden Academy of Fine Arts. This followed a productive architectural period until 1849 where he was forced to exile due to politic events, thus his theoretic work began and in 1851 'The four elements of architecture' was published (Schwartz 2017, 38-39).

Semper, being interested in the precedent set by the beginning of building, based his research on studies of primitive vernacular buildings. Linking fundamental typologies closely to local conditions and place. Where culture and climate are seen as fundamental drivers for the development of the built. Exemplified through the courtyard-building and the roof-hut, where the warmer climate sought shelter in the typology of the courtyard and the colder with heavier precipitation had its counterpart in the roof-dominated typology. Here in early examples the relationship to place is highlighted (Schwartz 2017, 42).

Semper divided the primitive buildings into four basic elements: the hearth, the earthwork, the framework and the enclosure. Ultimately classifying into two overarching architectural principles: the stereotomic and tectonic. Where the stereotomic (deriving from the craft of cutting stone) represents the massiveness of the earthwork and the tectonic as defined members of lightweight frameworks that are assembled together (Frampton 1995, 5). Linked to these elements Semper connected tectonic crafts. Textile to enclosure, carpentry to the framework, masonry to earthwork and metallurgy and ceramics to the hearth (Frampton 1995, 87).



Figure 1.2: Chapel of Reconciliation [Duncan Stephen]

Furthermore, Semper also emphasized the symbolic value of the tectonics, crafts and attributes - allowing for translation and interpretation. Referring to the Greek temple and the symbolic motifs that had been transformed from a lightweight nomadic structure to massive earthwork (Frampton 1995, 87). In the same manner as the representation in marking of ground create both a stable foundation and symbolizes the connection and definition of a place (Schwartz 2017, 43).

Stereotomic / Tectonic

Development of light and heavy structures are tightly connected to cultural development. Light structures starting as the primitive, temporary structures shaping huts etc. While the stereotomic demonstrate a permanence and more permanent. The interplay between these two tells a story about the development of settlements and civilizations (Deplazes 2005, 13). Influenced by the writings of Gotfried Semper.

Frampton highlights the distinction between tectonic and stereotomic as light and heavy, referring to the inherent light and heavy attributes typical material and techniques impose (Frampton 1995, 5). Which Deplazes highlights also implies various characteristics that could be linked both symbolic as a visual impression as well as structural substance. Tectonic characterized by slenderness, readability - focus on the systematic joining as Semper emphasized with its weaving and knotting. Tensile in its performance, drag and compress. Stereotomic characterized by an overall compactness, massive and three-dimensional. Performance driven by the pull of gravity. Compressive (Deplazes 2005, 14).

Consequently main difference between these two systems is the spatial shaping. The heavy, stereotomic space is characterized as an direct encapsulating structure, where the elements directly shape space. While the light, tectonic space with its tensile structure remain open in its essence, the structure is not defining the relationship between interior-exterior. Therefore a further layer of material (enclosure) is demanded to further define space (Deplazes 2005, 14).

Since space is experienced as a full bodily experience, space cannot only be about the relationship between interior, exterior. Thus arguably the open, readable filigree structure sets the essential experience of tectonic space, while the essence of the heavy structure is the total encapsulating of compact, continuous, three-dimensional mass.

Semper's four elements of architecture

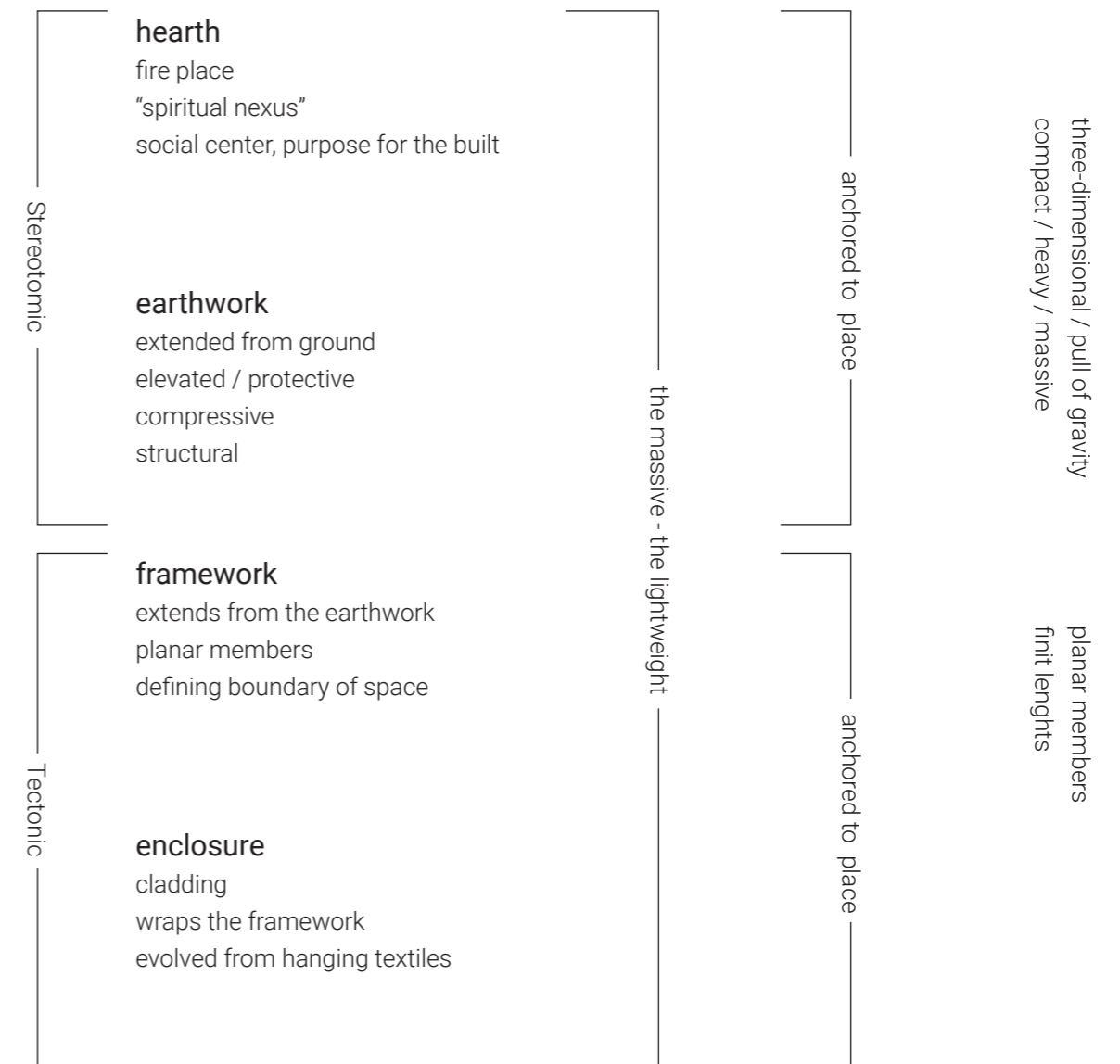

Gottfried Semper - 'Four Elements of Architecture' (1851)

Inherent techniques / attributes

HEARTH
Spiritual Nexus

Fire place



Gathering force



Purpose



EARTHWORK
Stereotomic

Extension of ground



Protective



Load-bearing



Masonry



Stone-cutting



Stacking / Compressive

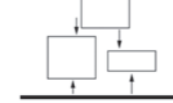

Sharp



Massive



Relational



FRAMEWORK
Tectonic

Cover



Structural support



Boundary of space



Roof



Carpentry



Wood



Filigree



Finite lengths



Open / Light



CLADDING
Enclosure

Capsulate



Defining space



Freestanding



Textile



Weaving



Knotting



Organic



Draping



Joints



Representational / Ontological

Going through literature there can be concluded that the spatial and tectonic assemblage has a type of communicative performance, its expression. Frampton (1995, 16) refers to Semper's distinction between the representational and symbolic attribute of tectonics oppose of the technical. Naming it representational and ontological, being the difference of visual representation and fundamental structural essence. Where Semper highlights the essence of earthwork, framework and roof while considering the hearth and infill wall in a more symbolic way.

Also Jacobs (2012, 6) mentions the example of the greek temple. Advocating for the "re-staging" and re-enactment of the tree in the temples load-bearing columns. Creating a symbol of its origin in a translated structure. Jacobs emphasize here that architecture then both becomes a symbol of its origin as well as something new. Moreover this mode of attributing establishes the base for Roman architecture, stretching into the classical architecture, later reinterpreted Renaissance. And the modernists interest and use of industrial buildings. By using an already "modern" connotation of the machines, trying to impose that onto architecture to claim a modernity. Furthermore Jacobs highlights that by re-enacting, architecture is dealing with the "shock" of something new, establishing bonds with the existing and setting itself in a historic context (Jacobs 2012, 6-7). This calls for an awareness of the built, what attributes etc there are and we can learn to reinterpret into something new. And it is through these glitches between tectonic ideas that help visualize the reinterpreted technological attributes, in the case of the greek temple case from wood to stone. While in other cases this might be more complex.

Topic of cultural dependence. Frampton exemplifies difference between Western and Japanese tradition of monumentality. Linking the western approach to stereotomy and permanence, churches, castles etc. while the Japanese tradition relies on tectonic, temporary structures, eg. knotted grass, rope, bamboo and wood. Leading to recurring re-building due to the limited durability of the material. Showing a different approach to time and monumental permanence (Frampton 1995, 15). Might offering an explanation on how the building culture, and access to material has shaped the act of building in Japan, Frampton (1995, 16) exemplifies the link to "spatio-temporal rhythms" transitional spaces.

Concluding reflection

In conclusion architecture becomes a gathering of experience, relating to our built environment. As well architecture becomes a representation itself. Through its hierarchy, architecture articulates a meaning. With the built, tectonic assemblage as a concrete medium to perform - a spatial experience is conceived. To really uncover the enactment of architecture and understand

the experience of space, working at the threshold between fiction and reality, the architectural tectonics becomes and the physical assemblage of the building becomes central. In its form having a duality of being both scenographic and binding.

Therefore I believe that to truly uncover an architecture that creates meaning there is a need for a holistic architecture. Being aware of the embedded experiences and emotions we as architects can evoke is of essential weight. And by studying spatial and tectonic ideas the architecture itself broadens. Consequently the rules or the set of principles that is gained, guided by tectonic theory more or less establish a way of rules to follow or break, in order to achieve a type of experience. Mimic, exaggerate. To study built examples of different experiences, associations and principles can be developed. To achieve different meanings etc. Drawing on the symbolical and structural attribute. Investigating the different performance and enactment of tectonic attributes. How the perception and enactment of architecture changes, using typical techniques, processes and structures. Tweaking the typical understanding.

1.3 References

Chosen examples of buildings that work with different aspects of materiality and tectonics. Exemplifying the principles derived from Semper, through the articulation of the platform, the enclosing membrane and a supporting framework structure.



Figure 1.3: Energy Hub [Jack Hobhouse]

Energy Hub
London, United Kingdom
2019

Architect:
Morris+Company



Figure 1.4: Industrial Building [Roland Halbe]

Industrial Building
Don Benito, Spain
2016

Architect:
Sanchez Garcia

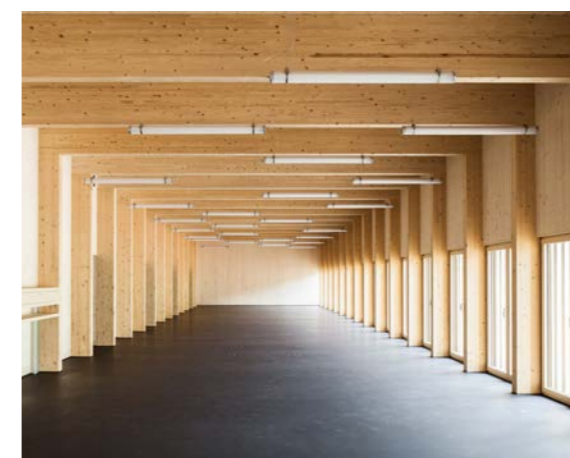

Figure 1.5: Sports Center Sargans [Roman Keller]

Sports Center
Sargans, Switzerland
2012

Architect:
Hildebrand, Ruprecht Architekten

Part 2 - Context



Skeppsbron - Gothenburg, Sweden

2.1 Site

History

Skeppsbron is a place that always has been in change, developing. There is a strong historical presence. In the beginning it was just a muddy part of the river, not accessible at all. The existing ground is extended into the river. It was decided to be a harbor area in 1913 and the work on the new quay was completed in 1845, with further extension to the west 1854-59 and towards Rosenlund in 1862-66. It was the first deep harbor quay where ships could stop, before the cargo had to be distributed through smaller boats to reach the city. In 1900 the quay measured to 634 meters, 200 meters longer than at present.

On site several different functions have taken place. There has been a bath house, brewery, mechanical workshop etc. The Rosenlund power plant's, completed in 1908, predecessor was a gas plant built in 1846. Between 1880-1920 the boat traffic had its main period. Allowing people to travel out in the archipelago and up north - creating a busy atmosphere (Carlsson & Wedel, 2017).

New Development - Rivercity

Overall city development around the river. Part of gaining access to the water. Mixed city program that enhances the accessibility in the area. Focus on public spaces, streets, squares. "A living room in city for all". Bigger public building at the end of the quay, proposed site, in front of the Rosenlund power plant. The quay is moved 15-40 meters out in the river. Five new building quarters, ranging from 5-11 floors, mainly 7-8. Integration of existing buildings. Mainly housing with retail and other program in the ground floor. The addition consists of approximately 400 new apartments, and 30 000 sqm for retail, offices and hotel. New quay consisting of parking underneath. Questionable solution due to cost. The municipality highlights the potential for the public building, in 2-3 stories it should be a building with public character. Hotel, school, offices not allowed. Planned construction from 2024, moving in approximately 2028 and onwards.

Figure 2.1: [Digitalt Museum]



Old harbour area

Figure 2.2: [Sweco Architects]



Overview new development

Historic timeline

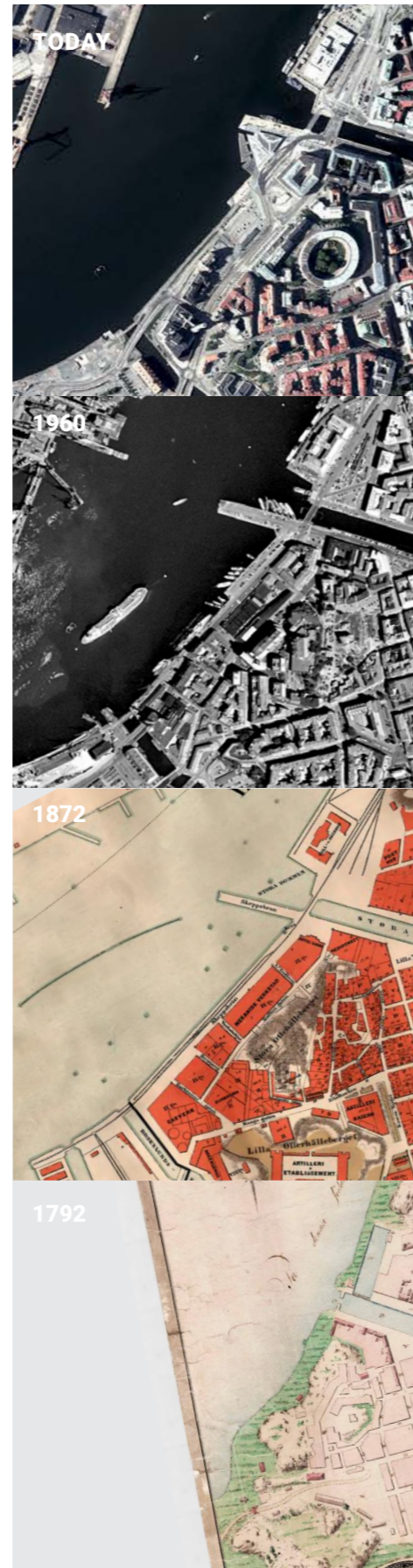
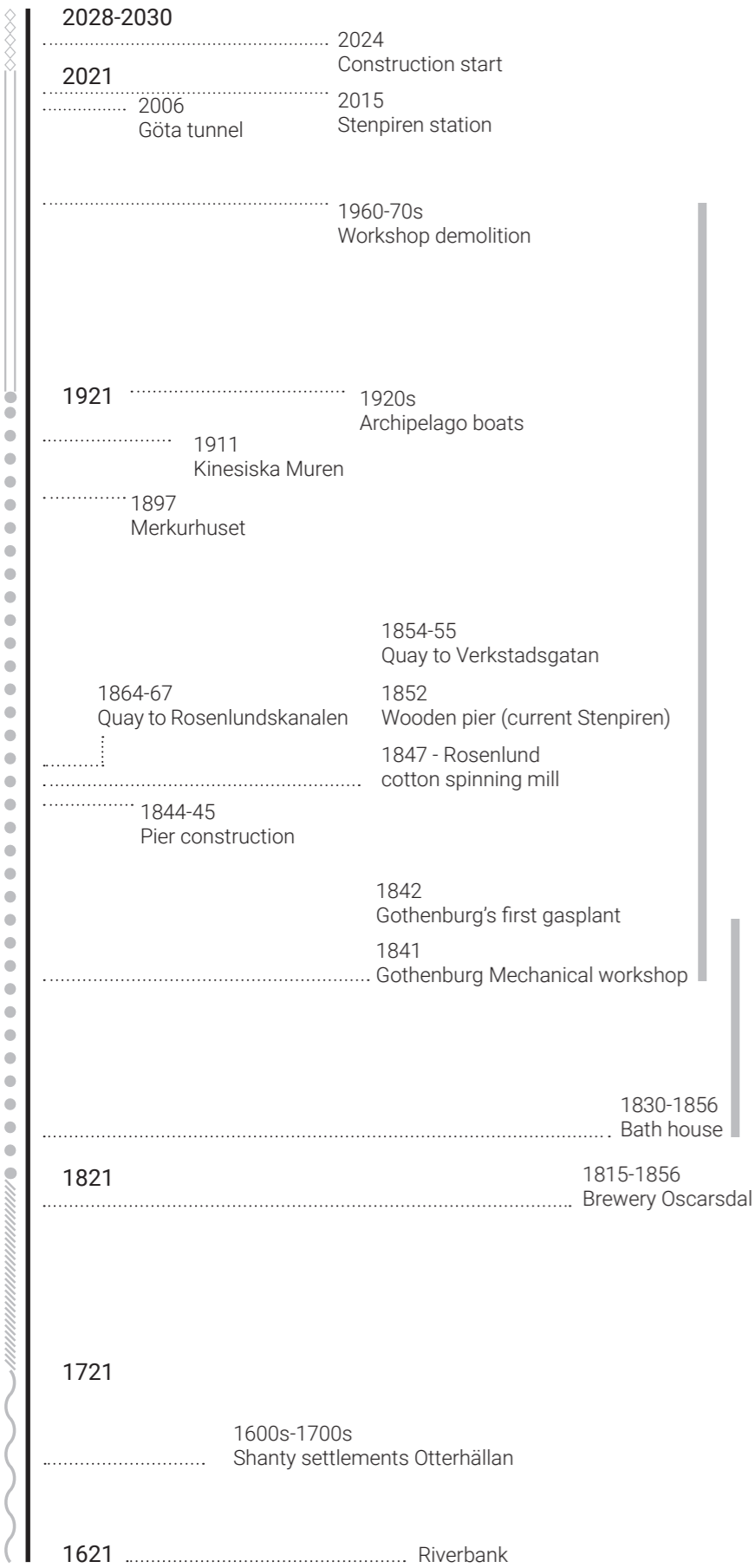

Historical layers

*new plan in blue

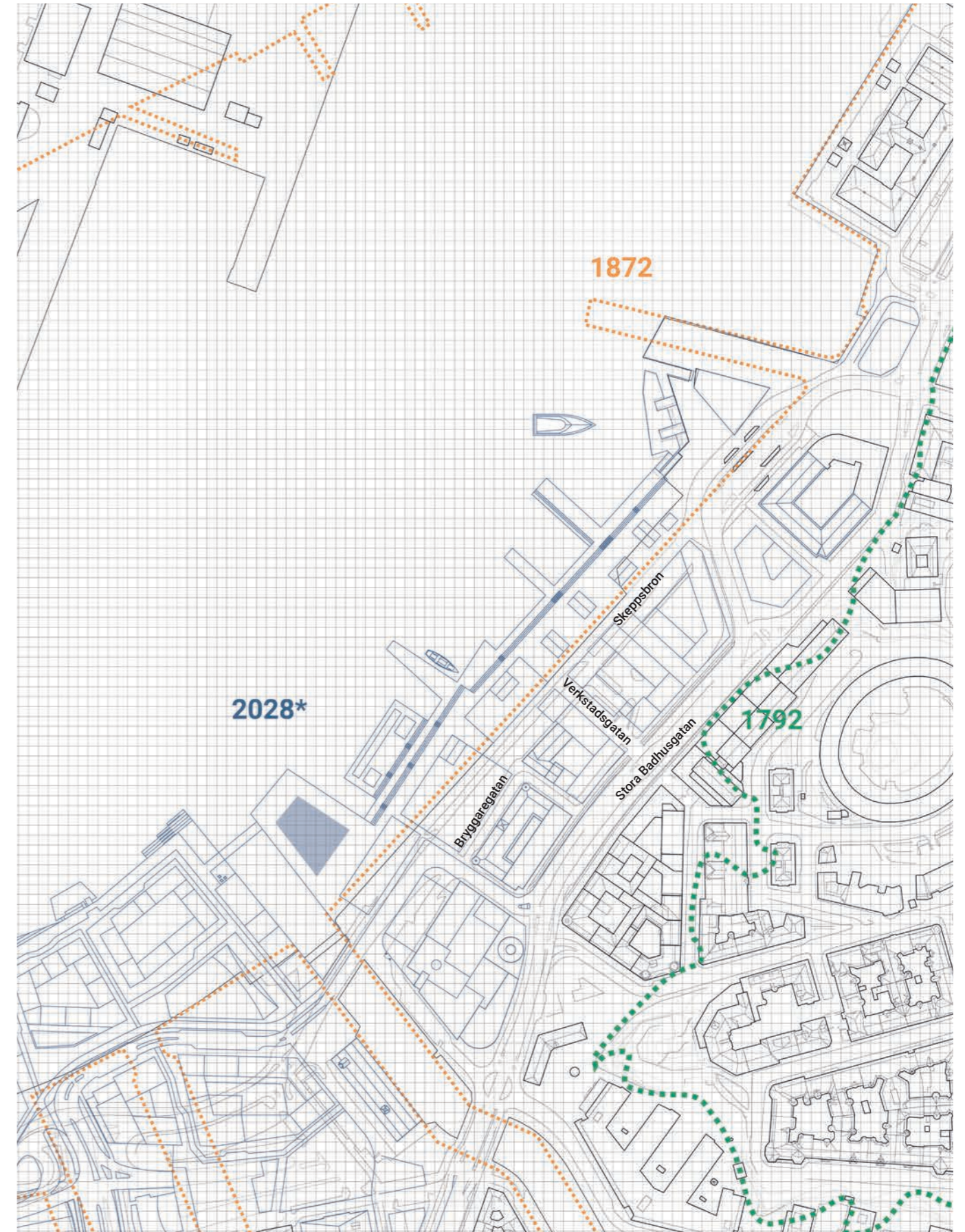

"Skeppsbron"

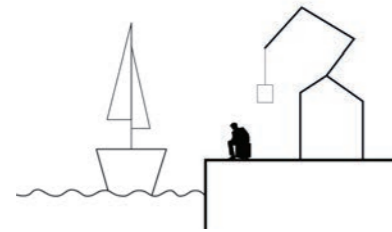

The harbor
Shipping, goods and exchange

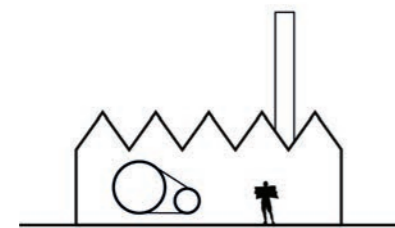

The workshop
Production, machines and goods

"Verkstads-gatan"



The bathhouse
Recreation and well-being

"Badhusgatan"



The brewery
Beer and beverages

"Bryggaregatan"

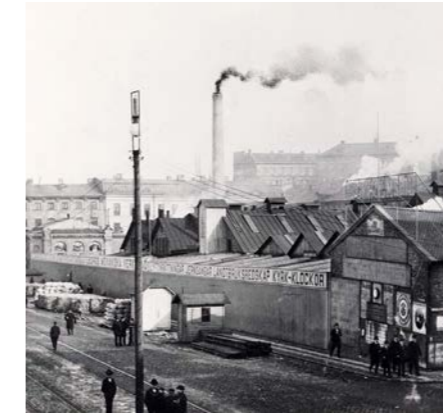

2.3 & 2.4



2.5 & 2.6



2.7 & 2.8

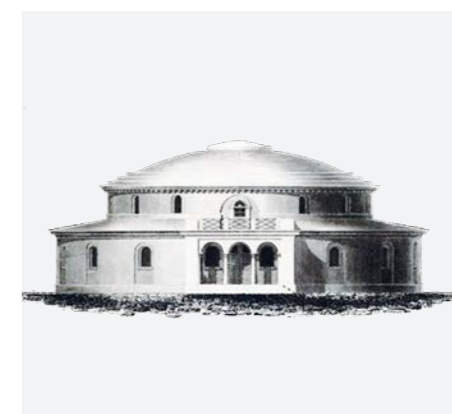

2.9 & 2.10

2.2 Analysis

The analysis started by establishing the public potential of the site. An important site in the site with a prominent water presence. The transformation of Skeppsbron allow new functions as the public bath, housing and business development that emphasize the importance of the addition a building will have.

Firstly the basic flows are established along the quaywalk as well as the supporting logistics. Giving the plot three public sides that also to connect to as well as manage the sunny locations at noon and evening. This gives the buildings an orientation that could benefit both the publicness with a building that open up to the important sides as well as a supporting backbone towards the vehicle access.

The municipality calls for: "New Livingroom in Gothenburg" that should invite the public. Linking to the heritage of the site as well as highlighting that and the character of Gothenburg also become natural. The industrial and harbor heritage of the site become a starting point to investigate a program that can link to the heritage of Skeppsbron on different scales.

In conclusion, the potential of the site should be articulated through the architectural assemblage of the building. Where the different qualities of the site are accentuated and enhanced through the tectonic substance of the framework, earthwork and enclosure.

Basic flows

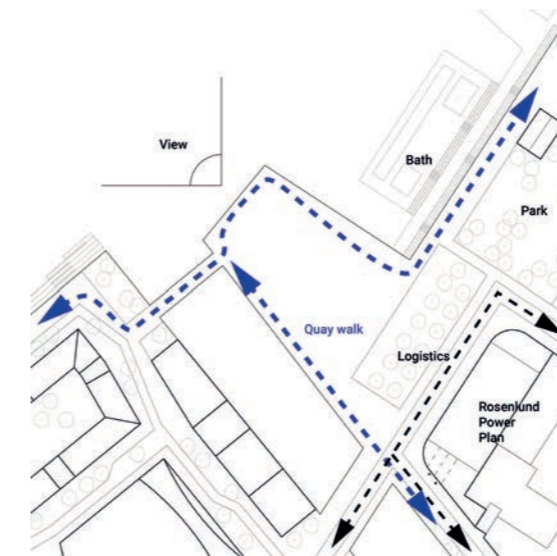

Sun

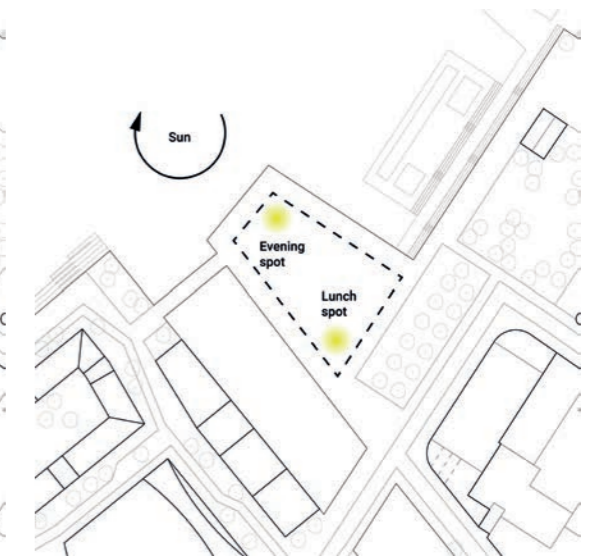

Public - Private

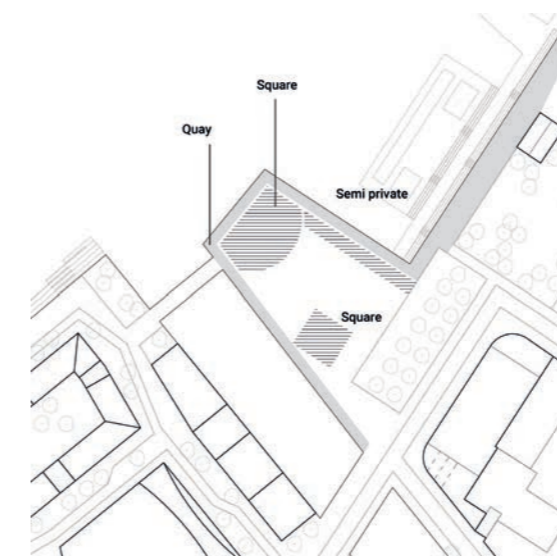

Geometry

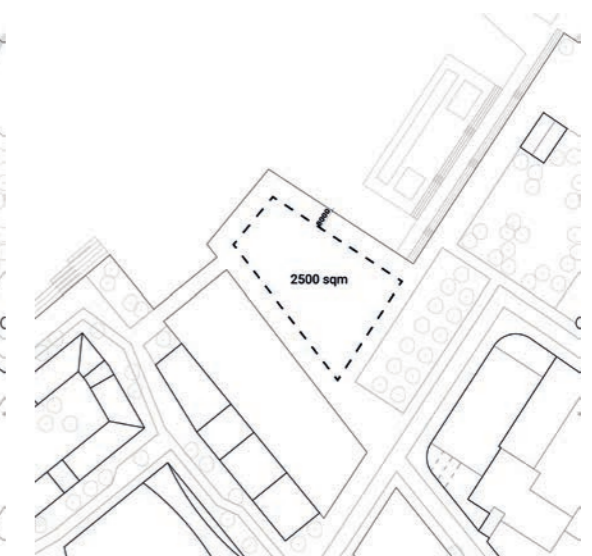

Access

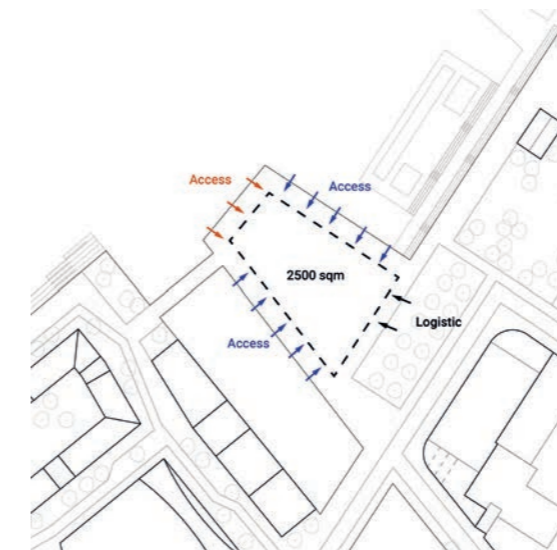

Building orientation

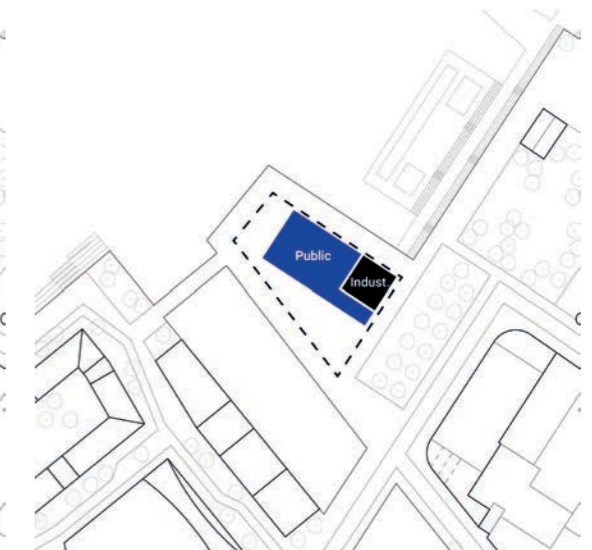

2.3 Program

Brewery and Taphouse/Restaurant

The precedent of a brewery on site in the 1800s sets a link to the heritage of the site as well as the history of Gothenburg. Brewing culture has been present since the founding of Gothenburg in 1621 and during the 1700s the export began to thrive. Names such as Carnegie, Poppels and Pripps are commonly known. During the 1990s many of the large scale breweries ended their production in the city. However due to the culture of micro brewing, small-scale and local producers has resurrected the production of beer in Gothenburg (Göteborg & Co, ?).



Poppels Citybryggeri
Brewery and Restaurant

Location: Gothenburg

Figure 2.11: [Poppels]

Space program

Public (tectonic)	700 m²
Restaurant/event space	400 m ²
Food stalls	100 m ²
Eating area	200 m ²
Industrial (stereotomic)	1370 m²
Brewery (stereotomic)	700 m²
Brew house	100 m ²
Fermentation house	100 m ²
Showroom	100 m ²
Office	60 m ²
Lab	30 m ²
Staff	50 m ²
Storage	100 m ²
Cold storage	60 m ²
Mechanical room	50 m ²
Docking	40 m ²
Keg cleaning	10 m ²
Restaurant	150 m²
Prep-kitchen	60 m ²
Wardrobe area	30 m ²
Toilets	60 m ²
Other	520 m²
Storage	20 m ²
Ventilation	100 m ²
Technology	80 m ²
Maintenance	30 m ²
Garbage	20 m ²
Service	270 m ²
Total:	2070 m²

Breweries in Gothenburg



Copenhagen Distillery
Distillery and Bar
Event 300 sqm



Figure 2.12: Event and taproom [Copenhagen Distillery]

Braunstein taphouse
Adept Architects



Figure 2.13: Visitors center and bar [Rasmus Hjortshøj]

Part 3 - Building

Concept



Industrial and public program
Bringing together - benefit from each other

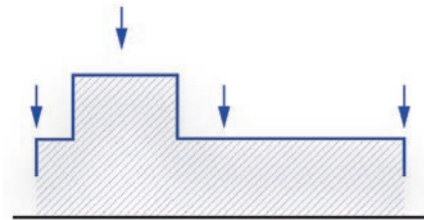

Coherent enclosure
Gather the program under a joint membrane, linking to the umbrella warehouse structure of Skeppsbron

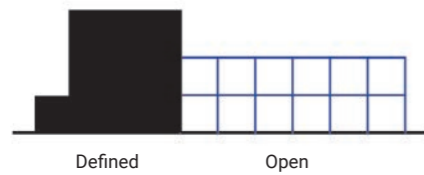

Tectonic articulation
Translate program and articulate space into stereotomic and tectonic substance

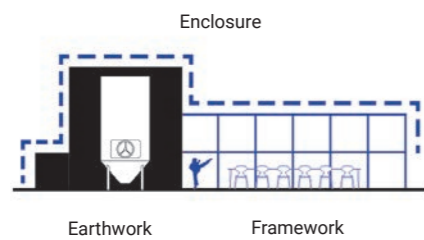

Concept
Structure that allows for the different functions to work together, joint under a common exterior. Tectonic articulation that exaggerate the experience of the public and industrial, open/light, closed/heavy.

Design synthesis

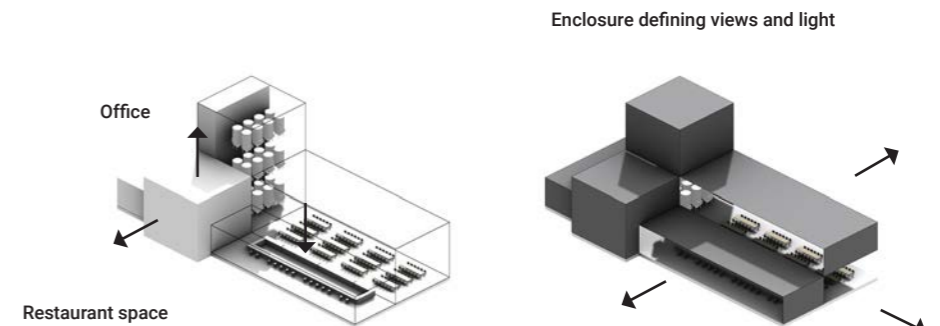
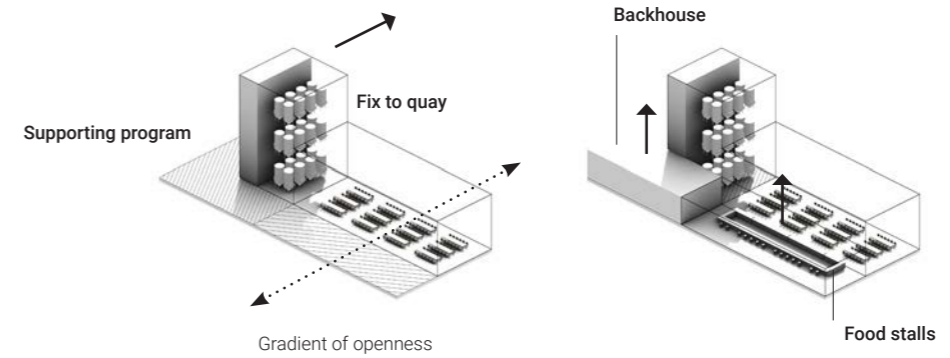
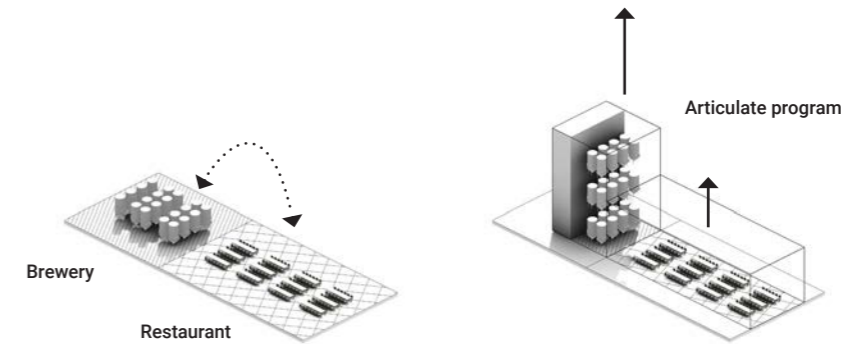



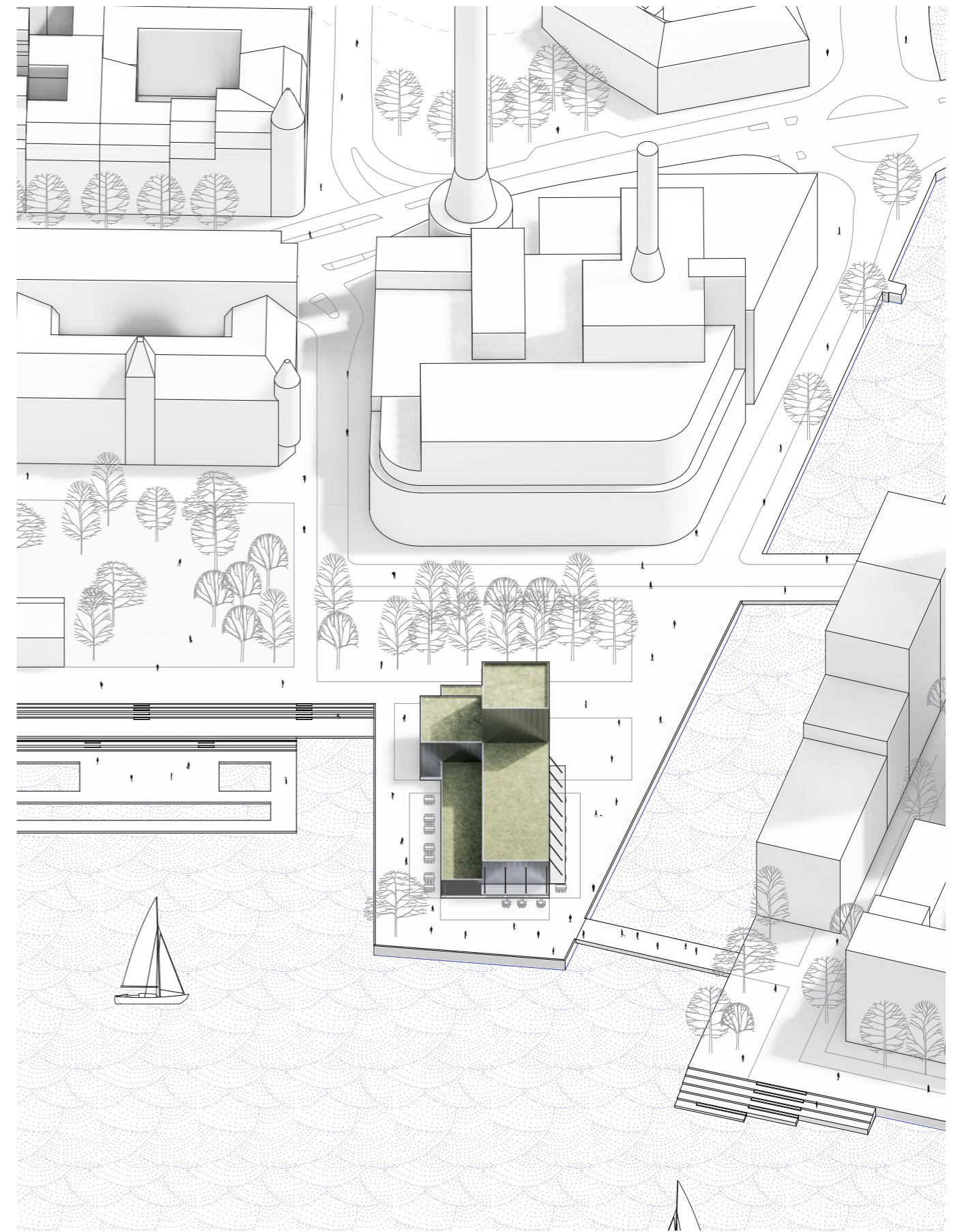
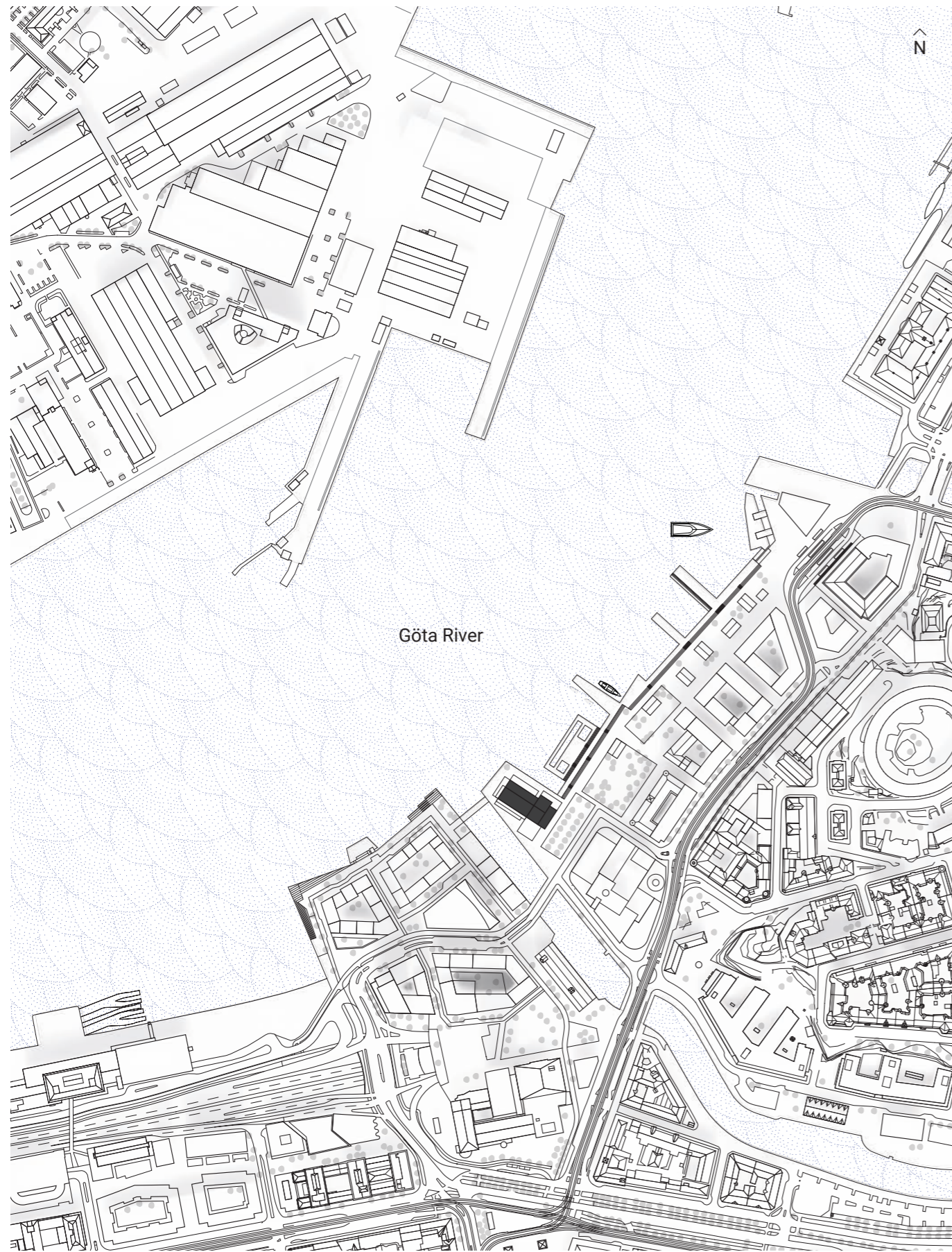



View from river

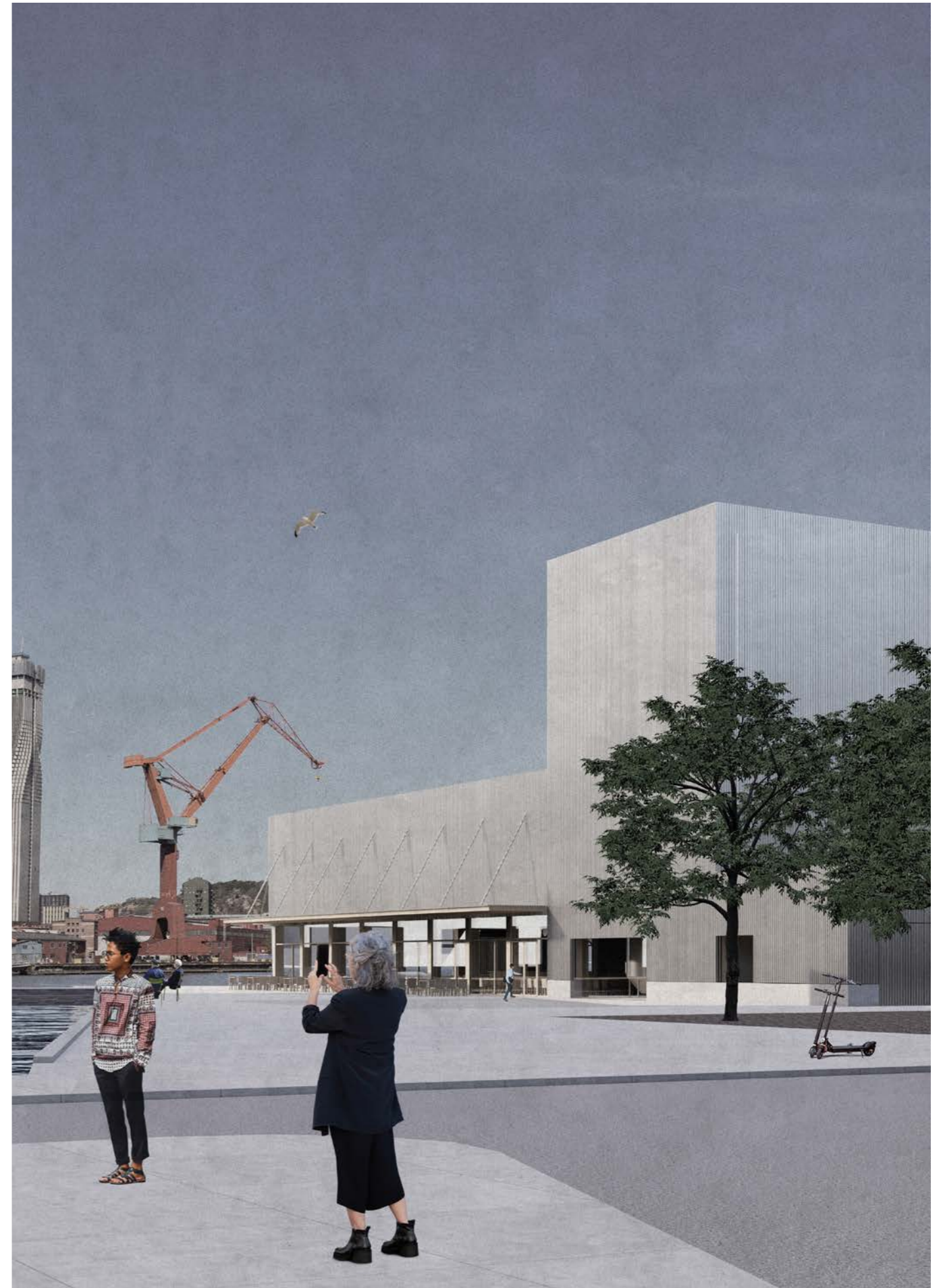
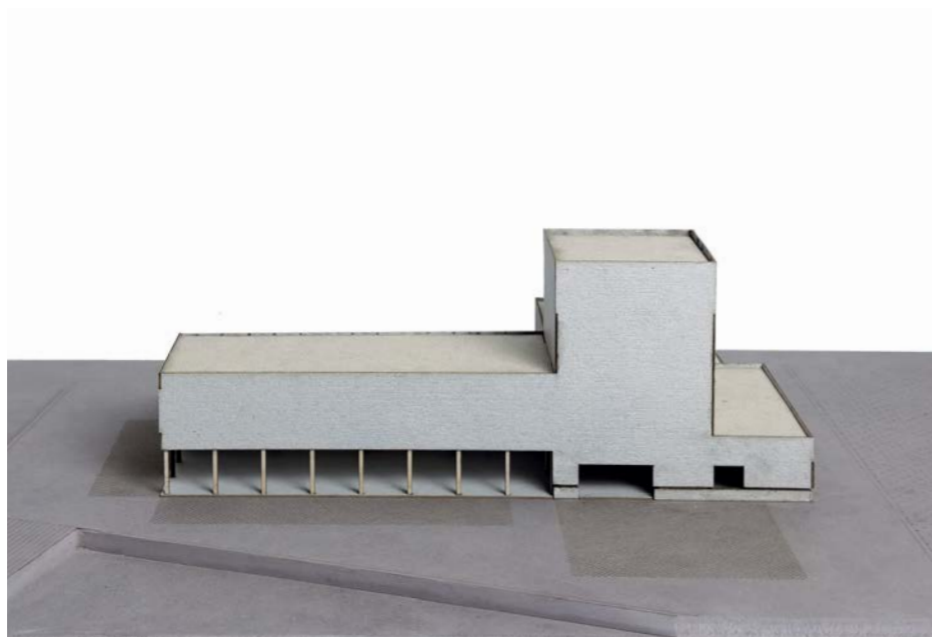

View from Rosenlund

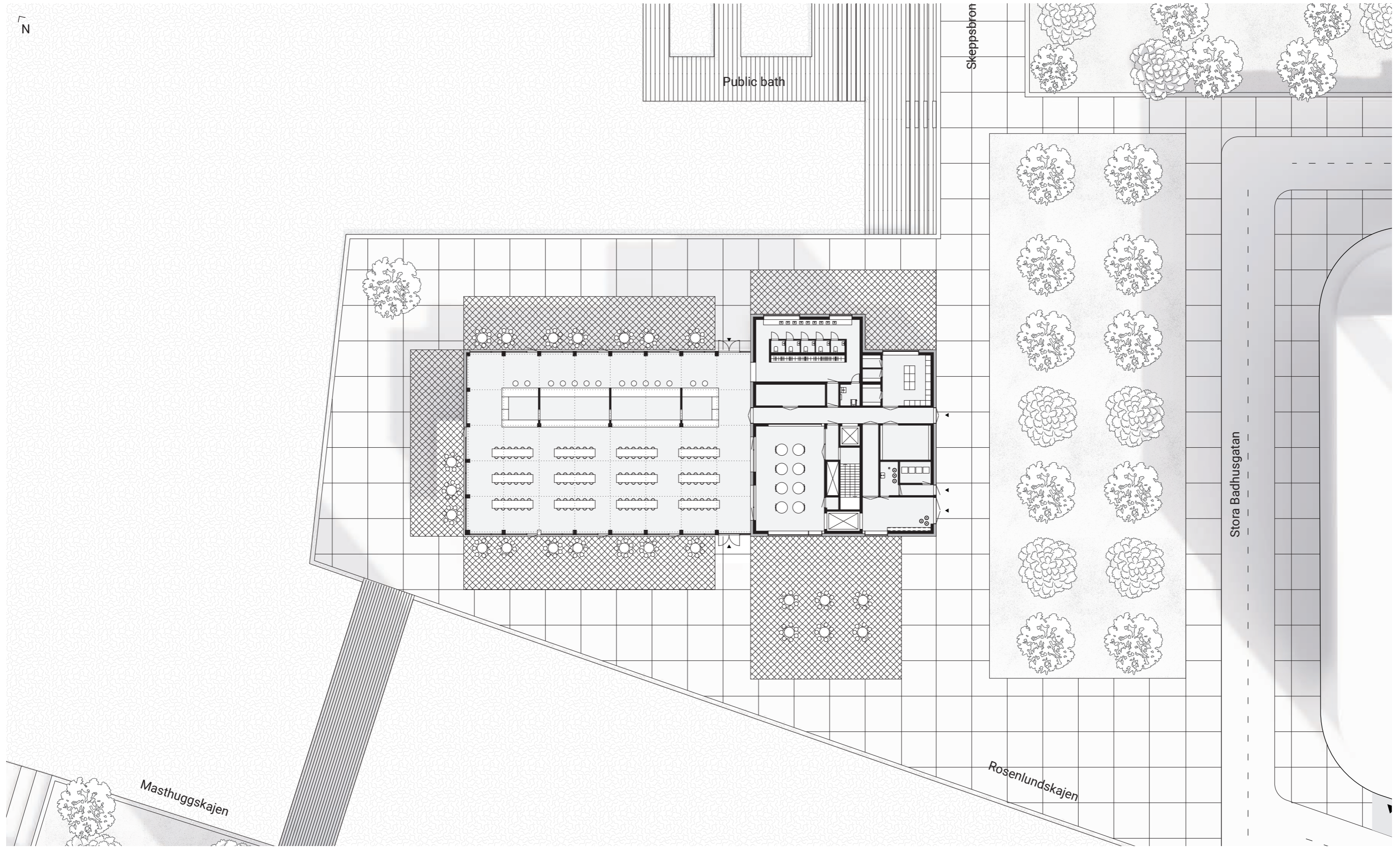



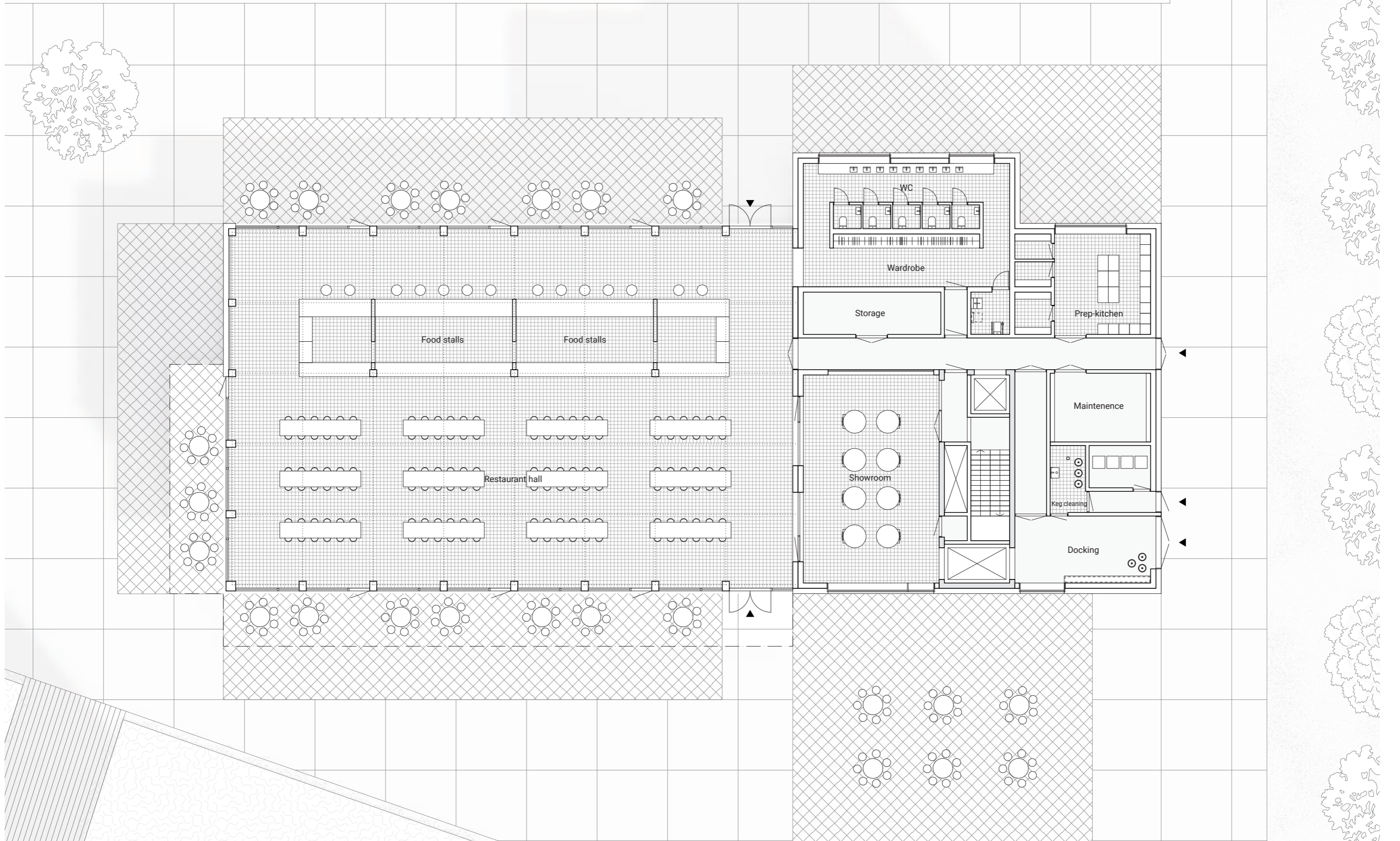

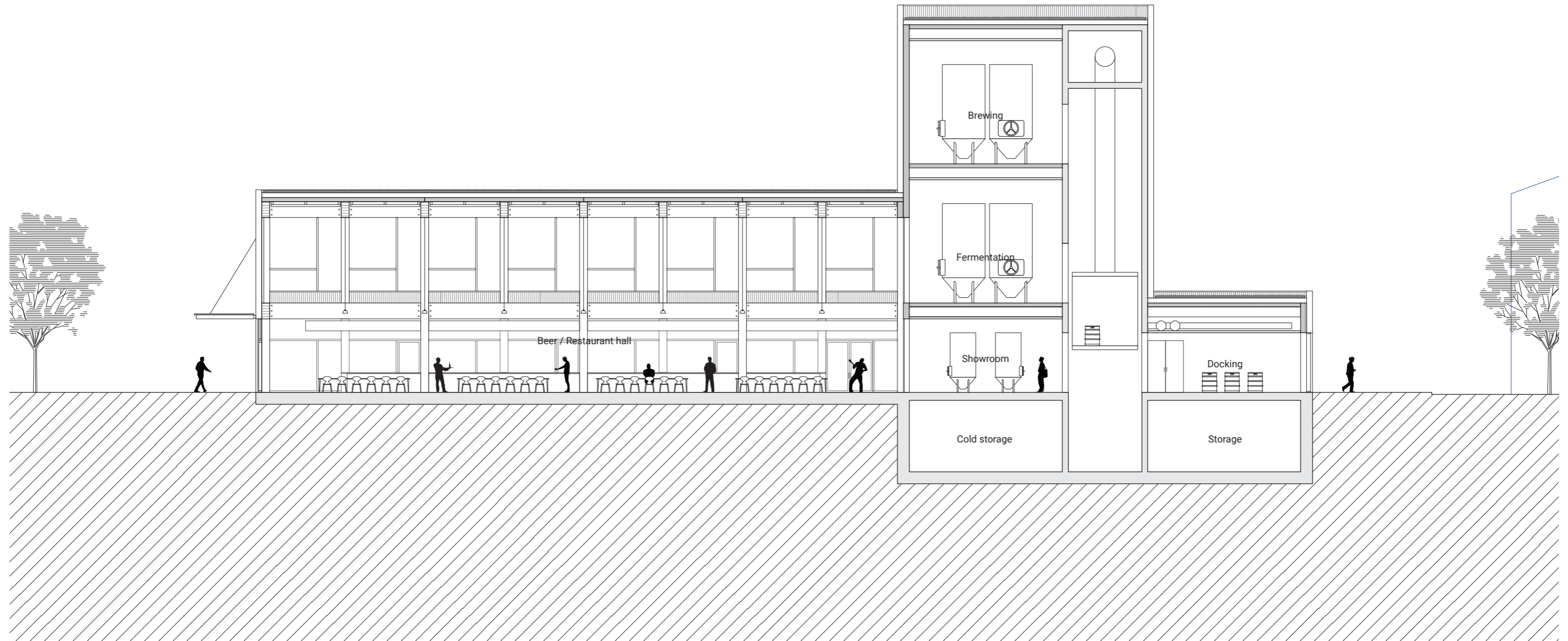
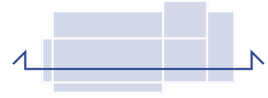



Plan 0
Scale 1:400 (A4)

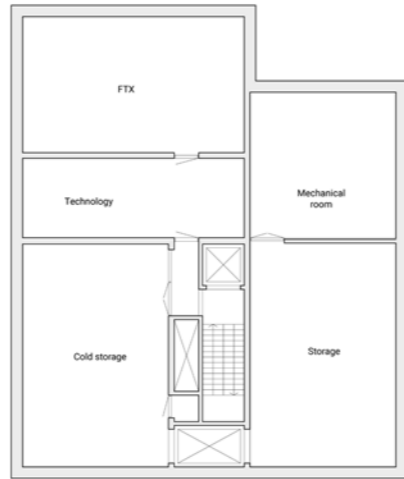

Plan 2
Scale 1:400 (A4)

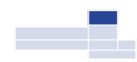
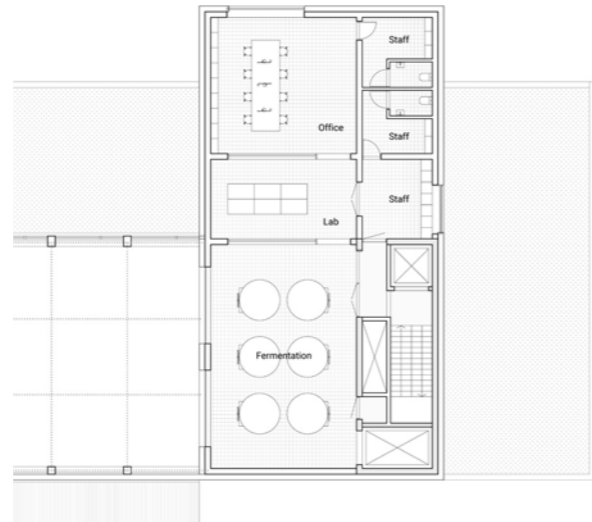

Plan 3
Scale 1:400 (A4)

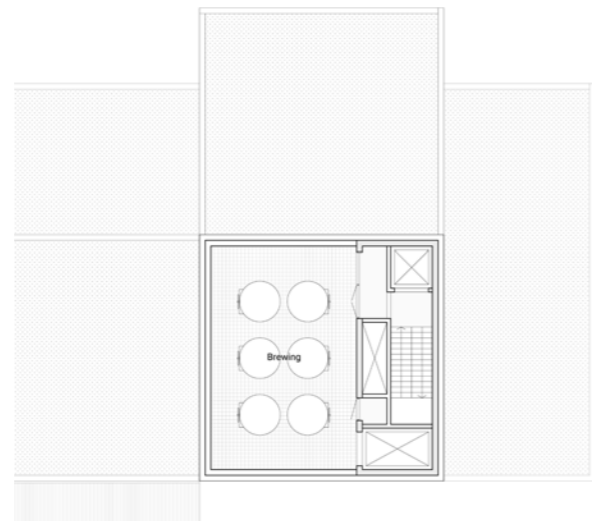

Food bar

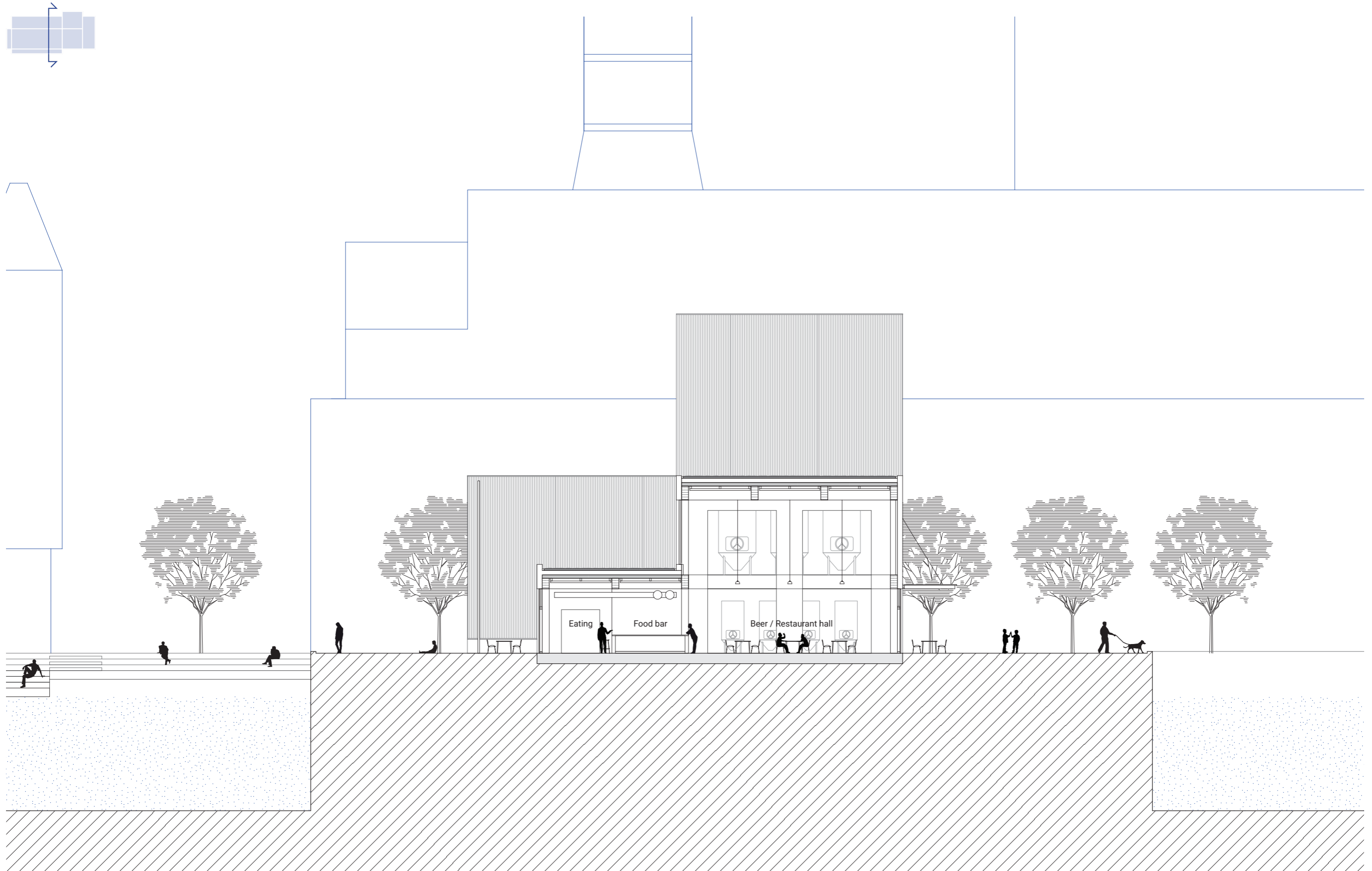



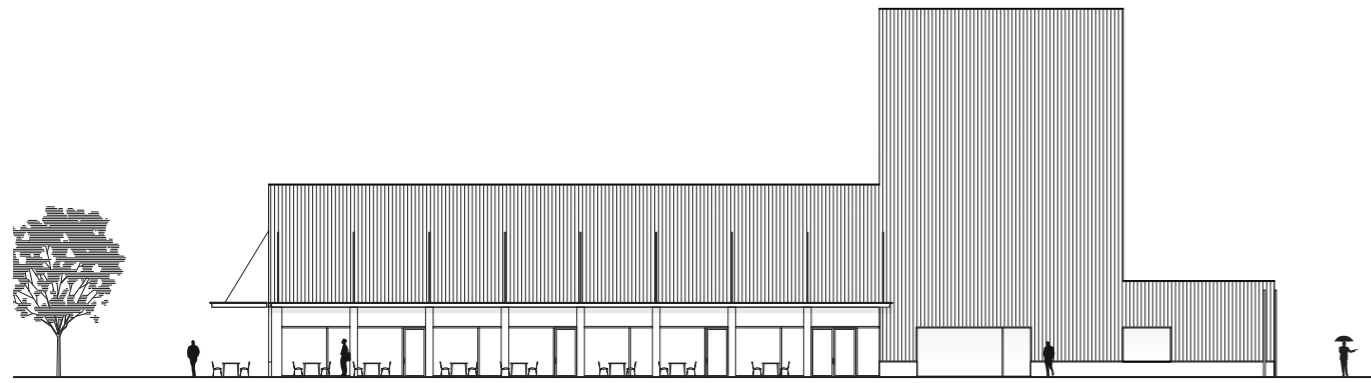

Facade Northeast

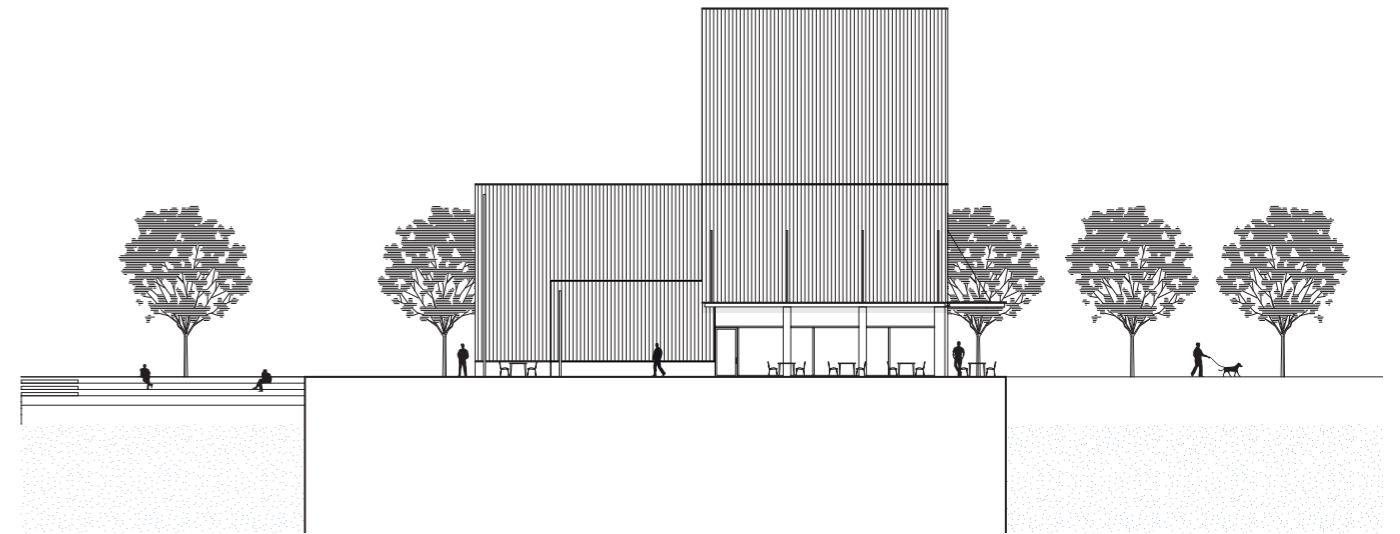

Facade Northwest

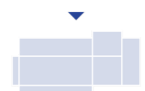
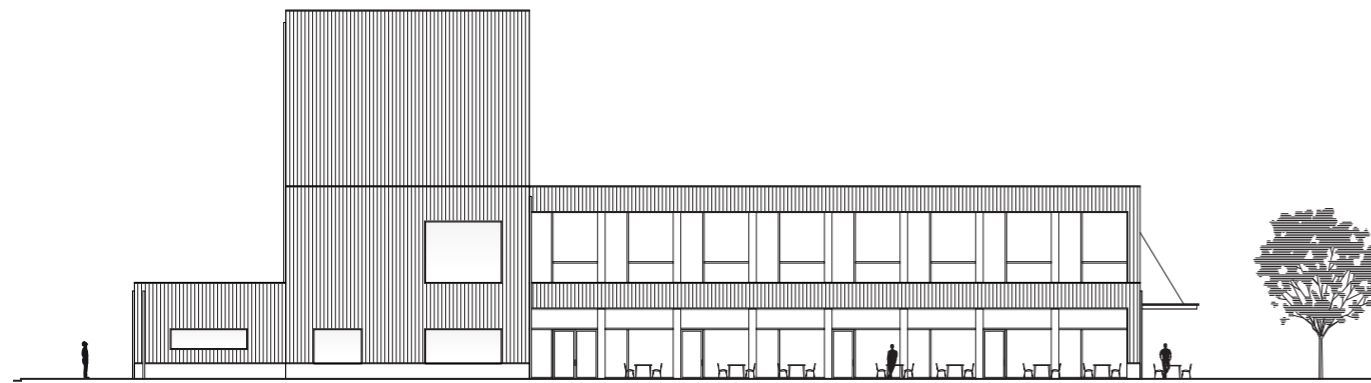

Facade Southwest

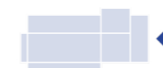
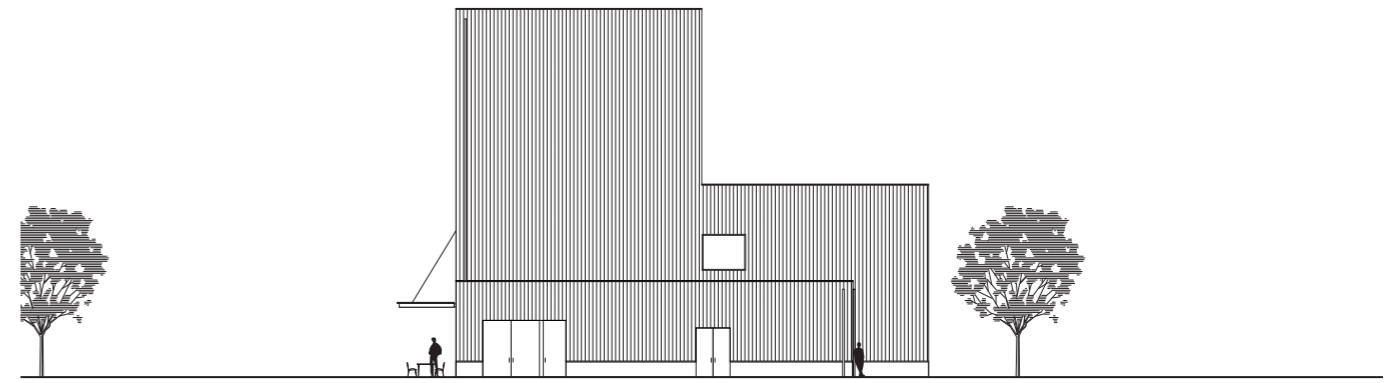

Facade Southeast



Hall_river



Hall_brewery

Building system

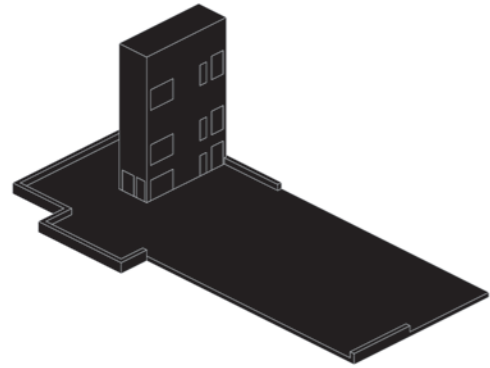

Extending from ground

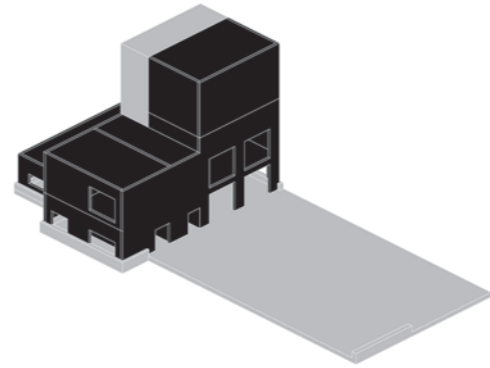

Massive structure

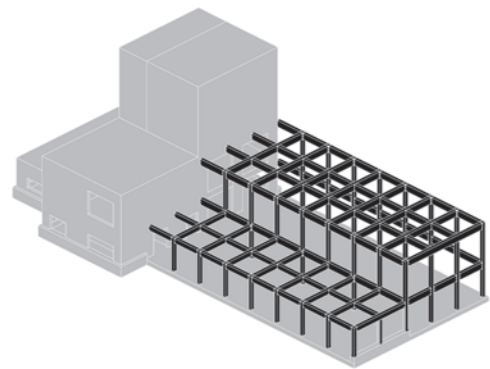

Framework

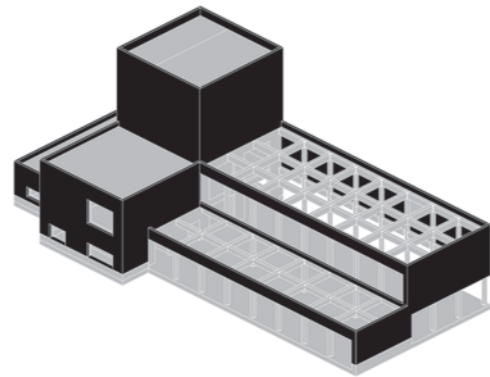

Enclosure

Exploded system

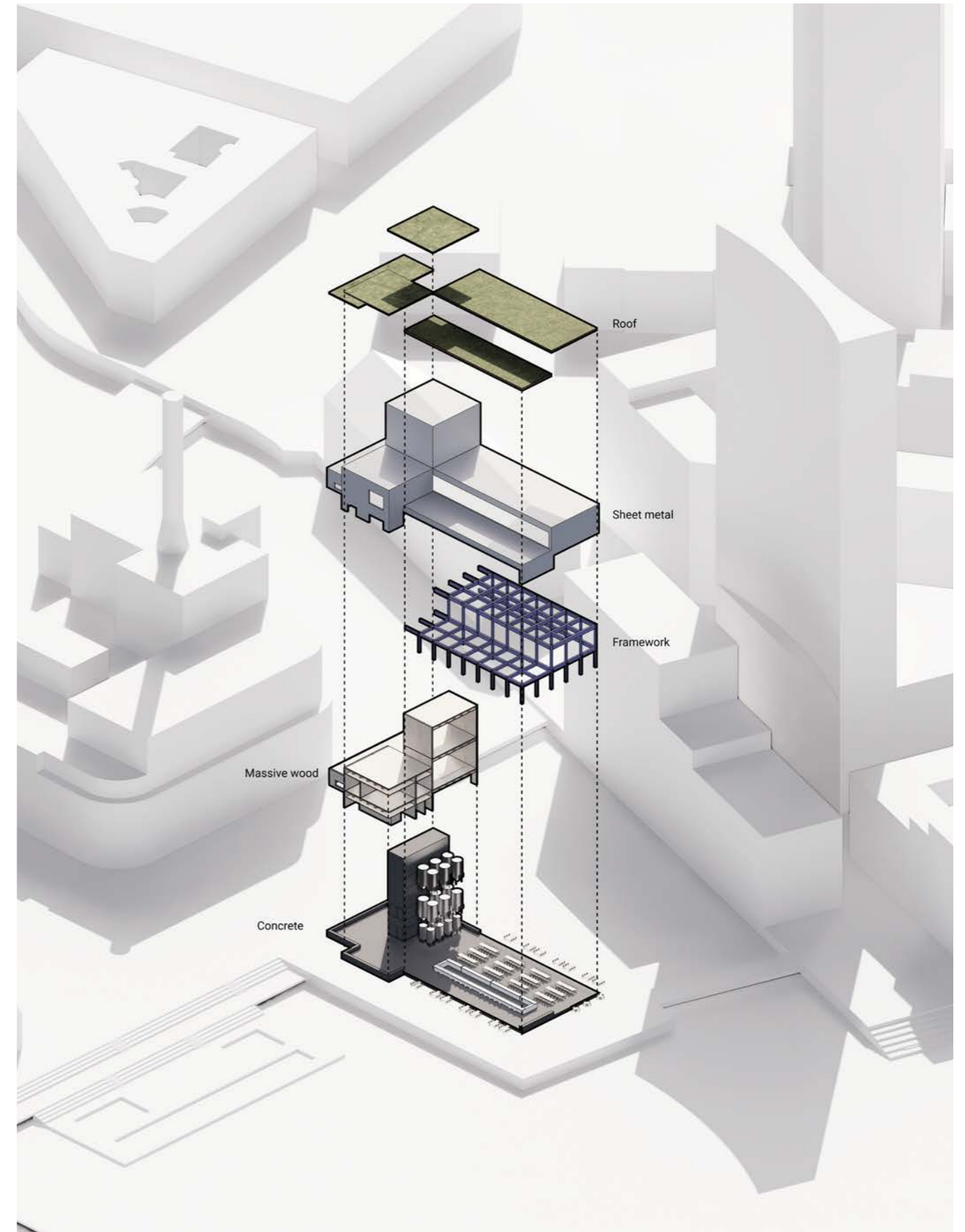

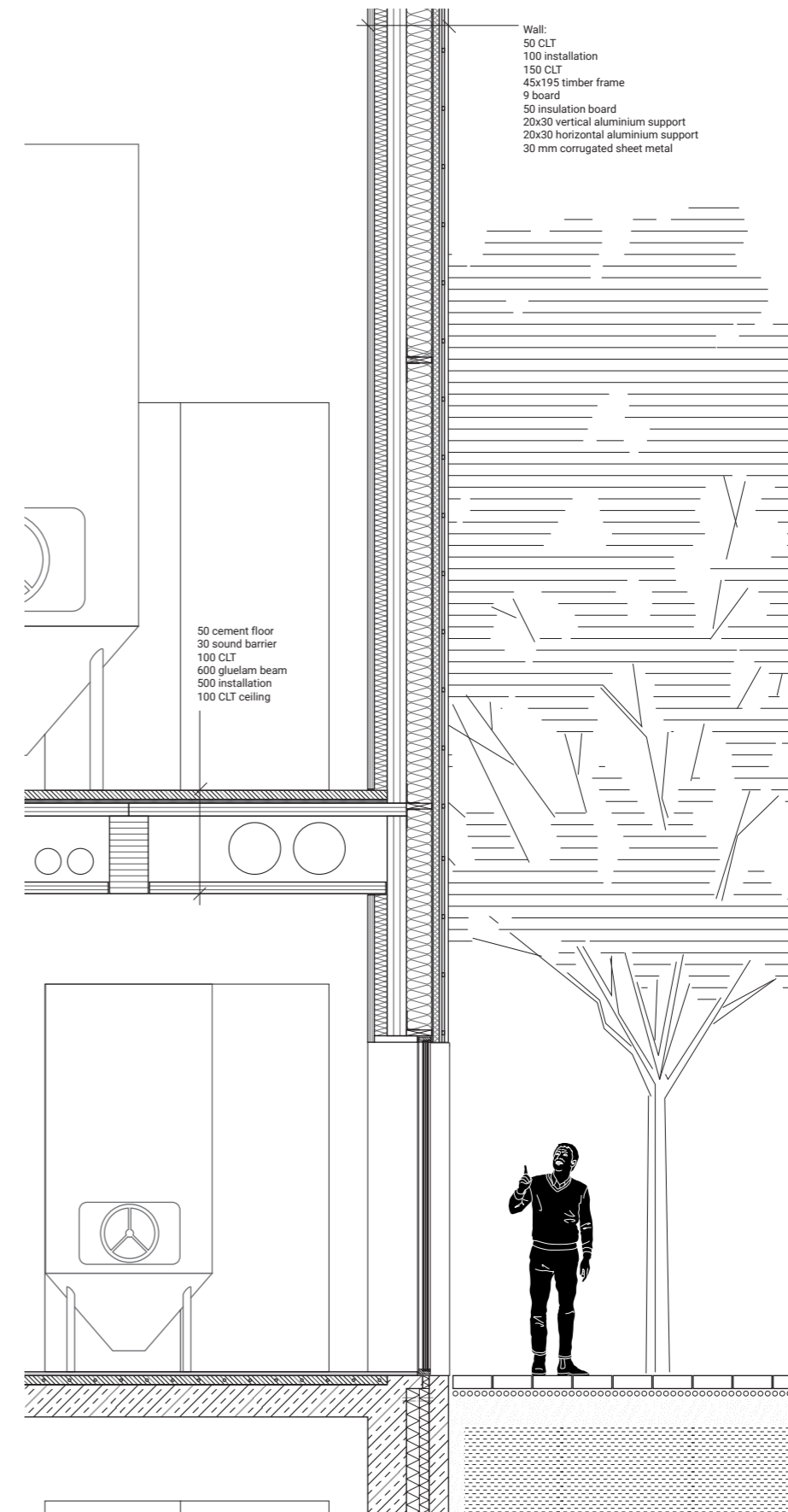
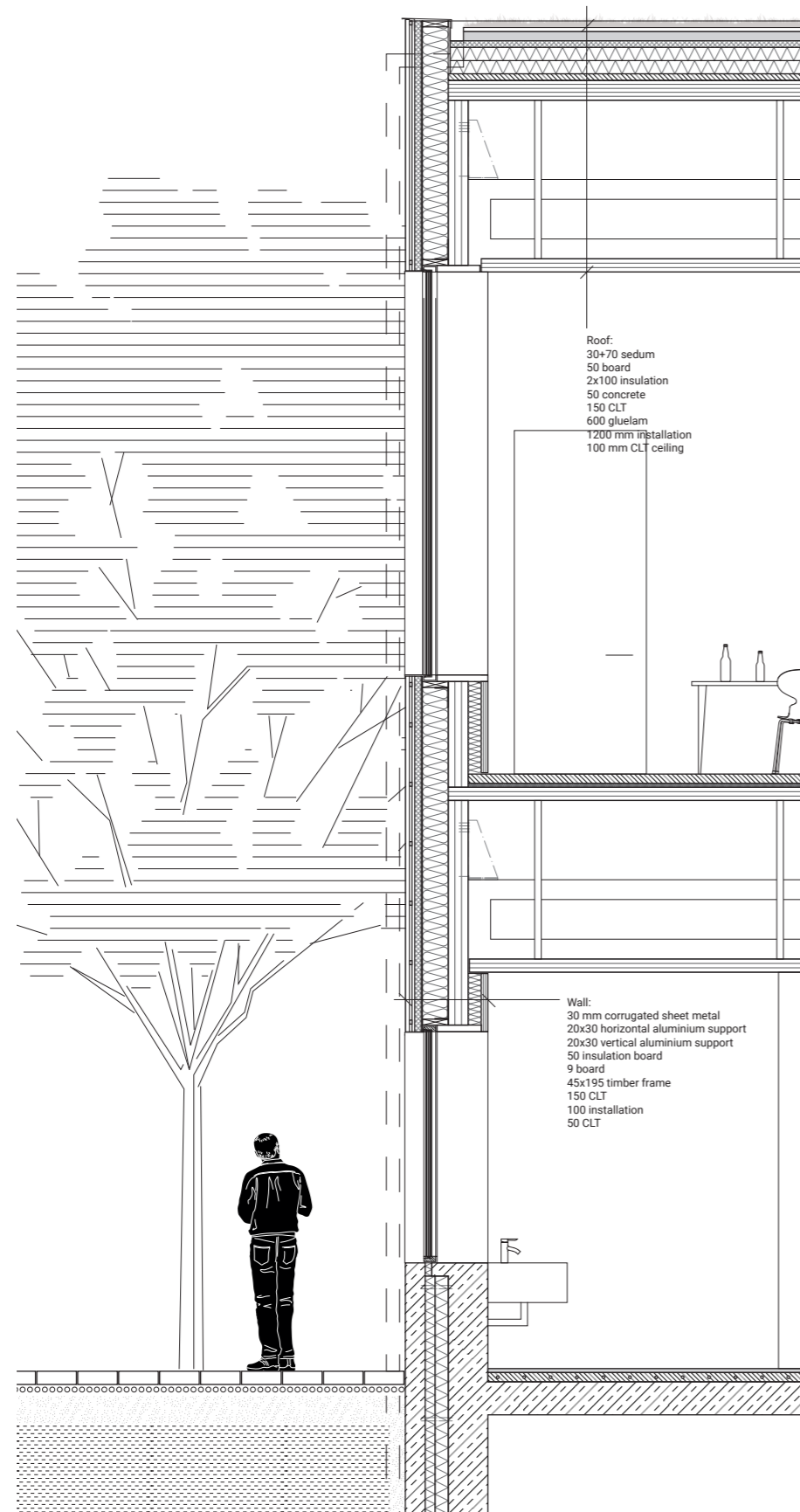

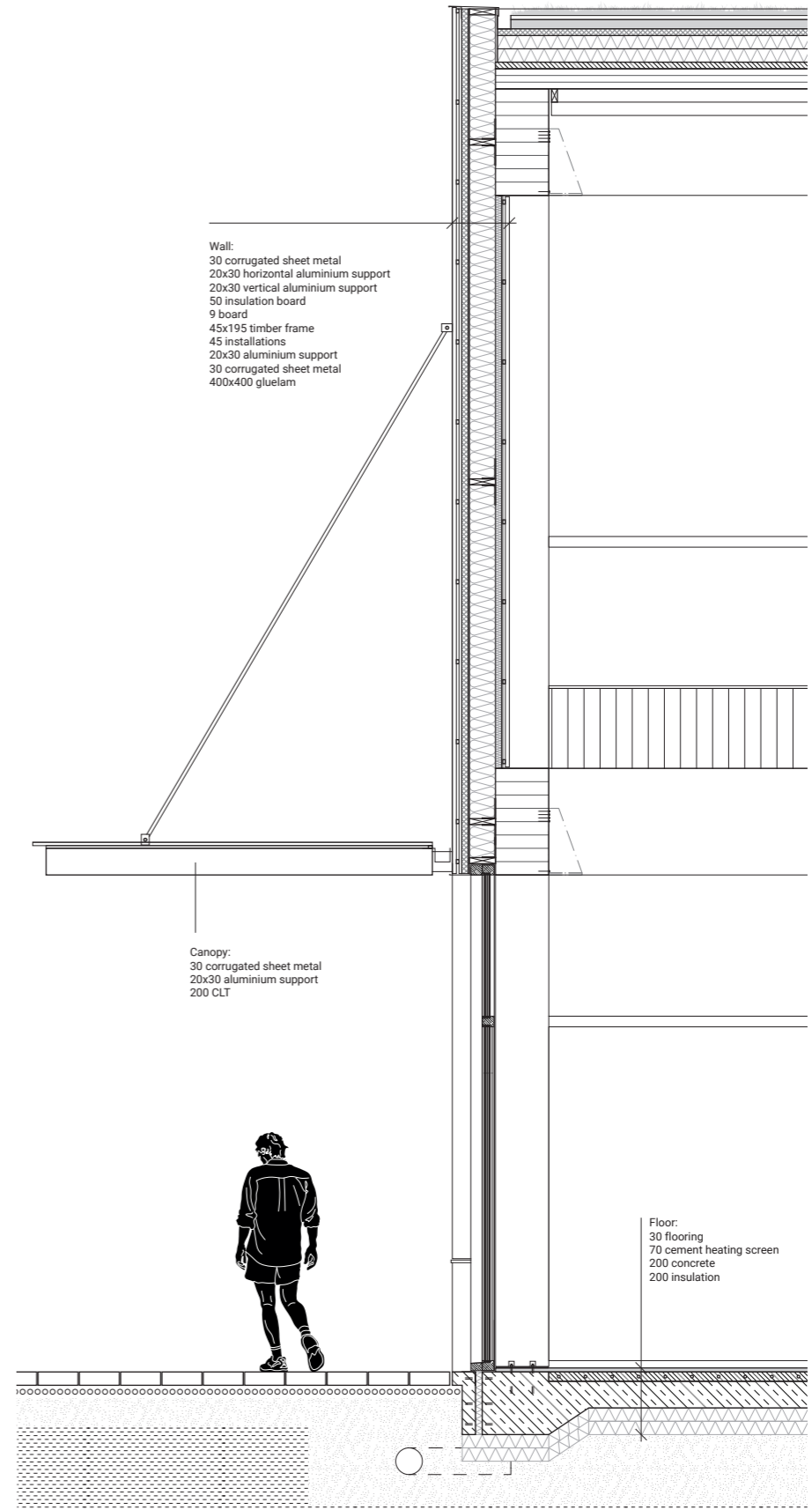
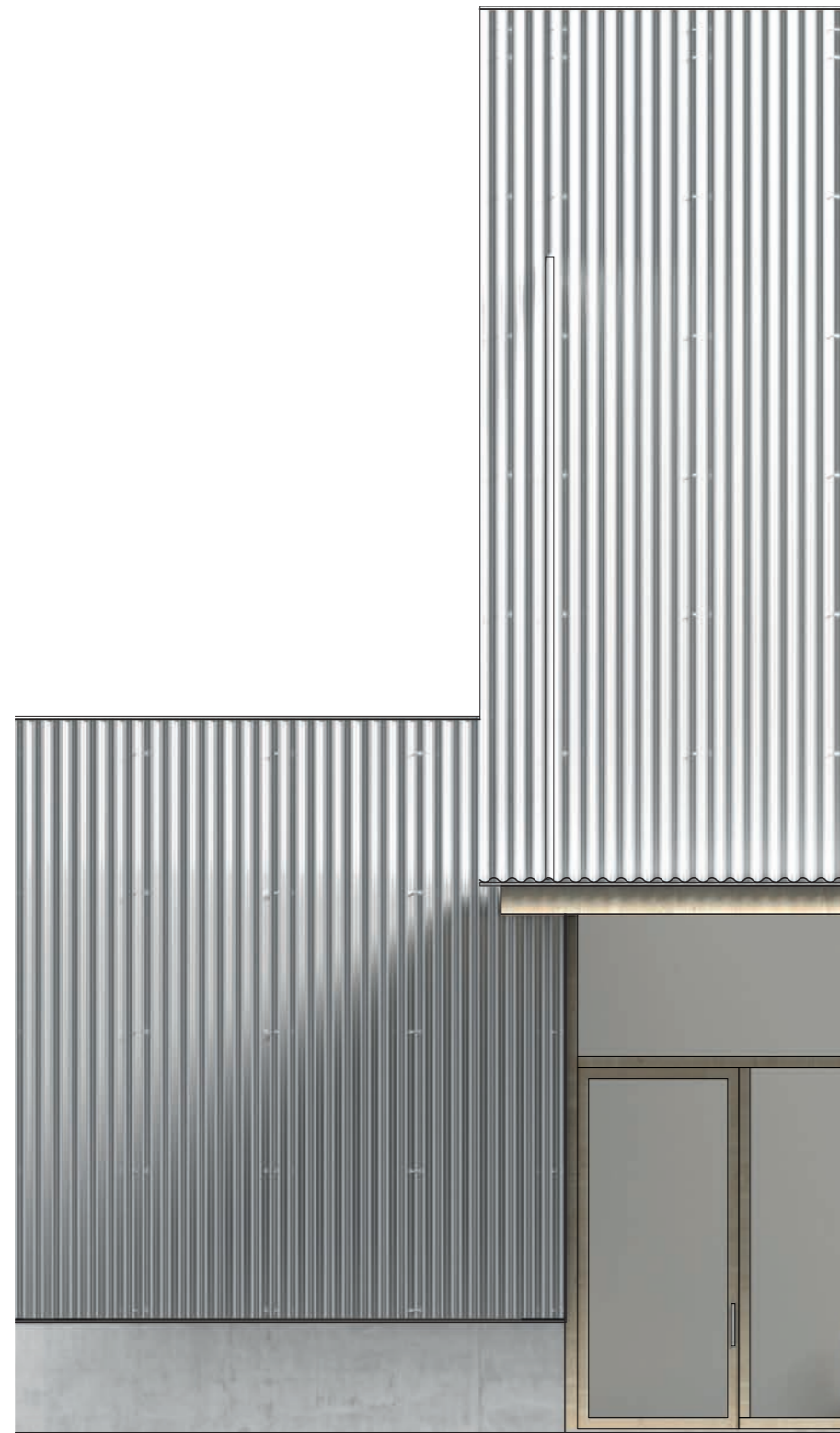

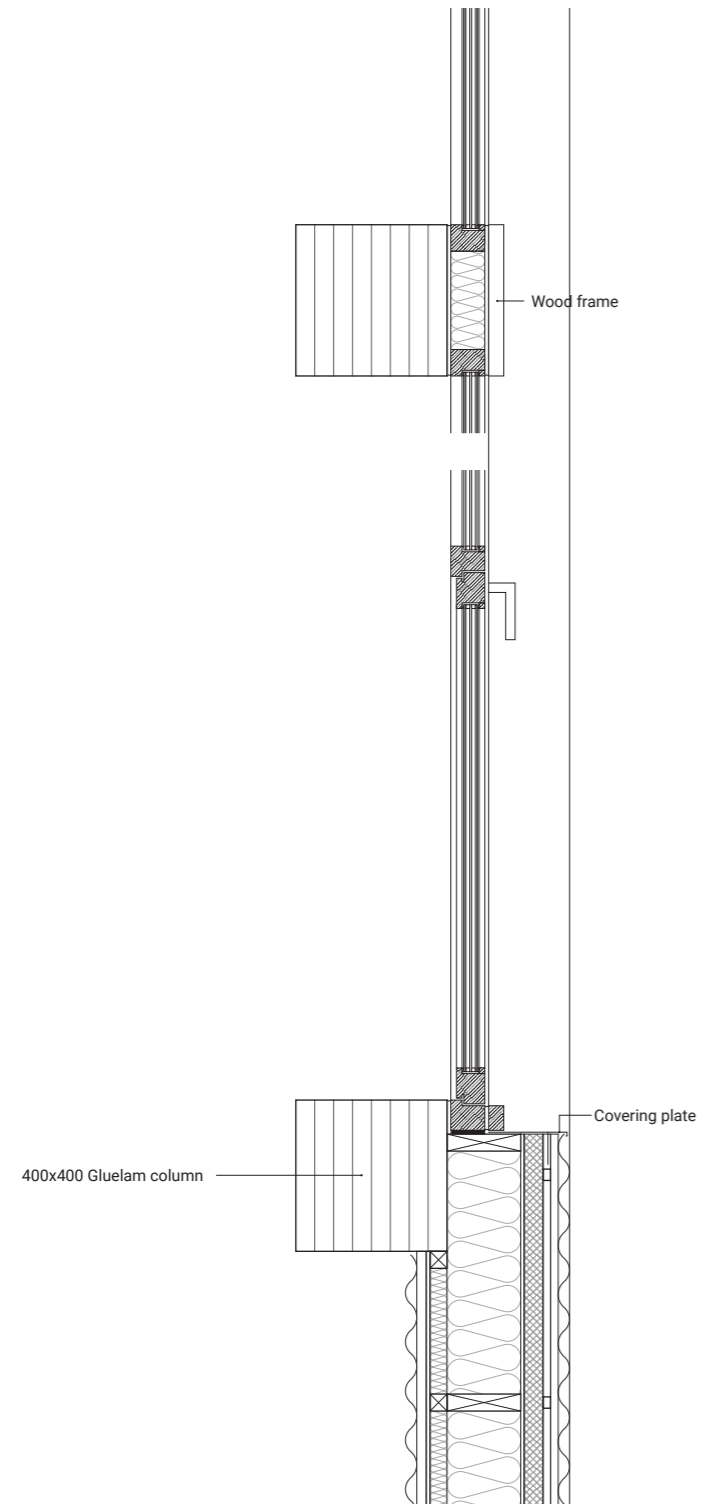

Discussion

In conclusion, this thesis project has explored the potential of architectural tectonics as a means of developing a design framework for creating a spatial experience. The project's focus on the principles of stereotomic, tectonic, and enclosure has provided a solid foundation for the development of the project. The process of the thesis started through studying relevant theory to set the thesis in context. At this point it was quite unsure what the building could be, that would exemplify the relevant studies would offer for the design process. Preferably, the project would benefit from a building program that allowed for expressing different types of space, a program that would hold different qualities and functions that could be articulated through the tectonic assemblage. A theater for example that is predominantly public in its character but also holds a lot of logistic backspaces was an interesting idea to pursue with the idea of the stereotomic and tectonic, the heavy and light.

By choosing the site Skeppsbron, the thesis was put in a Gothenburg context and a relevant task in the development of the city. Through the analysis of the site and the historic heritage previous ideas of different building typologies, that could have suited the scope of the theory, that had been discarded. To fit into this realistic task, the project had to evenly relate to the site as the idea of the tectonic assemblage. It was found difficult to design a building based only on a desired architectural experience, that could be perceived too formal. However, Skeppsbron offered this duality between industrial heritage and an important public site in the city. Which linked the design project to the theoretic study. This is where the idea of the brewery in the city, a combination of a factory and public venue appeared. Through the traces of a brewery on site, for example in the street names "Bryggaregatan" the idea of a joint brewery and restaurant program started to form.

The design process quite straight forward reconceptualize Semper's four elements of architecture into design principles in the project. Using the tectonic attributes of the substances, the earthwork, framework, and enclosure was the starting point. The hearth, the gathering force in this sense is the brewery in the heart of the project. Working with mainly wood in both a massive and tensile manner and the enclosure being translated into metal sheets.

Following these principles has resulted in a design that bring different architectural qualities together, that somehow support the program through the experience of the architecture. The open framework restaurant open up to the exterior and invites the public in. The massive brewery manages to incorporate the functions and reveals a more enclosed experience which suits the pro-

duction. Creating synergy between the different parts of the building. Overall, this thesis project has demonstrated the potential of applying tectonic principles in architecture while also considering the historic and cultural context of the site. Providing an example how theory, design, and reality work together. The resulting design create a site-specific solution that contributes to the development of the city as well as relating to Gothenburg as a whole.

Bibliography

Books

Norberg-Schulz, C. (1980). *Genius Loci: Towards a phenomenology of architecture*. Rizzoli.

Frampton, K. (1995). *Studies in Tectonic Culture: the poetics of construction in nineteenth and twentieth century architecture* (J. Cava, Ed.). MIT Press.

Andrea Deplazes, C. E., Sascha Roesler, Cordula Seger, Tobias Siegrist. (2005). *Constructing Architecture: Materials, Processes, Structures* (A. Deplazes, Ed.). Birkhäuser.

Pallasma, J. (2005). *The eyes of the skin: architecture and the senses*. John Wiley & Sons Ltd.

Zumthor, P. (2006). *Atmospheres*. Birkhäuser.

Zumthor, P. (2010). *Thinking Architecture*. Birkhäuser.

Jacobs, S. (2012). *Make It Real: Architecture as Enactment*. Strelka Press.

Schwartz, C. (2017). *Introducing Architectural Tectonics*. Taylor & Francis.

Wedel, K.; Carlsson L.O. (2017). *Skeppsbron i Göteborgs hjärta*. Breakwater Publishing.

Figures

1.1: Ibsen, Flemming. (2016). *Bruder Klaus Chapel* [Photograph]. Flickr. <https://shorturl.at/nyJS3>

1.2: Duncan Stephen. (2016). *Chapel of Reconciliation* [Photograph]. Flickr. <https://shorturl.at/BKQ06>

1.3: Hobhouse, Jack (2021). *Energy Hub* [Photograph]. Archdaily. <https://www.archdaily.com/961643/energy-hub-morris-plus-company>

1.4: Halbe, Roland (?). *Industrial Building Don Benito* [Photograph]. *Arquitectura Viva*. <https://arquitecturaviva.com/works/industrial-building-in-don-benito>

1.5: Keller, Roman. (2019). *Sports Center Sargans* [Photograph]. Archdaily. <https://www.archdaily.com/923990/sports-center-sargans-ruprecht-architekten-plus-hildebrand>

2.1: Unknown. (?). *Skeppsbron* [Photograph]. Digitalt Museum. <https://digitaltmuseum.se/021016316219/vy-over-goteborgs-hamn-till-vanster-skeppsbron-och-masthugget-till-hoger>

2.18: Sweco Architects. (2018). *Skeppsbron Overview* [Photograph]. Göteborgs Stad. <https://goteborg.se/wps/portal/start/goteborg-vaxer/hitta-stadsutvecklingsprojekt/stadsomrade-centrum/skeppsbron>

2.3: Unknown (1902). *Workshop* [Photograph]. Göteborgs stadsmuseum. <https://samlingar.goteborgsstadsmuseum.se/carlotta/web/object/470845>

2.4: Olsson, Carl Mikael (1901). *Workshop interior* [Photograph]. Göteborgs stadsmuseum. <https://samlingar.goteborgsstadsmuseum.se/carlotta/web/object/470858>

2.5: Nordisk Konst (1930). *Otterhall* [Photograph]. Göteborgs stadsmuseum. <https://samlingar.goteborgsstadsmuseum.se/carlotta/web/object/485178>

2.6: Göteborg Konstförlag AB (1921). *Boats* [Photograph]. Göteborgs stadsmuseum. <https://samlingar.goteborgsstadsmuseum.se/carlotta/web/object/483929>

2.7: Backlund, Anna (1915). *Rosenlund* [Photograph]. Göteborgs stadsmuseum. <https://samlingar.goteborgsstadsmuseum.se/carlotta/web/object/484297>

2.8: Unknown (1915). *Rosenlund 2* [Photograph]. Göteborgs stadsmuseum. <https://samlingar.goteborgsstadsmuseum.se/carlotta/web/object/483802>

2.9: Unknown (1910). *Merkur* [Photograph]. Göteborgs stadsmuseum. <https://samlingar.goteborgsstadsmuseum.se/carlotta/web/object/369443>

2.10: Broling, Carl Abraham (n.d.). *Bath house* [Drawing]. Göteborgs stadsmuseum. <https://samlingar.goteborgsstadsmuseum.se/carlotta/web/object/370073>

2.11: Poppels (2023). *Citybryggeri* [Photograph]. Beernews. <https://www.beernews.se/articles/poppels-nya-bryggeri-ska-bara-gora-pilsner/>

2.12: Copenhagen Distillery (2021). *Event and taproom* [Photograph]. Feinshmeckeren. <https://feinshmeckeren.dk/vin/copenhagen-distillery-fra-whisky-droem-til-virkelighed/>

2.13: Hjortshøj, Rasmus (2020). *Visitors center and bar* [Photograph]. <https://www.archdaily.com/951074/braunstein-taphouse-adept/5fa9434a63c017759b00092d-braunstein-taphouse-adept-photo>

Historic maps. Retrieved from <https://goteborg.se/wps/portal/start/bygga-bo-och-leva-hallbart/bygga-riva-och-forandra/stadsbyggnadsforvaltningens-kundservice/historiska-kartor>

Webpages

Göteborg & Co. (?). *Göteborgs hantverksbryggerier*. Retrieved from: <https://www.goteborg.com/guider/olpubar-i-goteborg> (2023-05-09).

Skeppsbron Brewery
2023 | Master thesis in architecture
Chalmers University of Technology

Alexander Svensson