

REIMAGINING SPACE

TRANSFORMING A RURAL FARMHOUSE INTO A MULTI-RESIDENTIAL
HOUSING SOLUTION IN SWEDEN



Erika Perleroth

Master thesis 2024

Chalmers School of Architecture

Department of Architecture and Civil Engineering

Examiner: Kaj Granath

Supervisor: Anna Braide

Cover photo: Ängagården, taken by Lillemor Eklund, 1990

REIMAGINING SPACE

Erika Perleroth
2024

Chalmers School of Architecture
Department of Architecture and Civil Engineering
MPARC
Architecture & Advanced Programmes

Examiner: Kaj Granath
Supervisor: Anna Braide



CHALMERS
UNIVERSITY OF TECHNOLOGY

ABSTRACT

The supply of housing in the countryside of Sweden today is rather limited, with most dwellings being large villas or farmhouses. While many people of the Swedish population have stated they wish to live in the countryside, most of them don't for various reasons, one of them being the lack of alternatives. At the same time, many farmhouses in the countryside are today not being used to its full potential, or at all.

Through literature studies, case studies, and research by design, this thesis explores how traditional Swedish farmhouses in the south, "skånelängor", can be transformed into multi-residential communities by redistributing the space within. This transformation is attempted while also preserving the architectural heritage, as this type of dwelling constitutes the foundation of the cultural landscape in the region. This new type of living situation will be created by answering the research question:

How can the transformation of large farmhouses in rural Sweden contribute to sustainable development by creating multi-residential communities, while preserving the cultural heritage of these buildings?

The design project of this thesis is situated

in the outskirts of Vellinge, in the south of Sweden. The site is characterised by the typical farmhouse of this region, with a rich cultural and architectural heritage. It is surrounded by acres of agricultural fields, with a view of the Öresund Bridge.

By developing a housing situation which involves sharing the space of an existing farmhouse, it is possible to maximise the usage of this space. The usage of this building provides an alternative way of living in rural areas, as well as the opportunity for the younger generation to move to the countryside, while also repurposing and extending the life of existing buildings.

The thesis is finalised with a design project, showing a possible solution for a multi-residential community within a farmhouse, meeting several sustainable developments and a design approach to preserve the heritage.

Keywords: *countryside, housing, alternative dwellings, repurpose, social sustainability, heritage, transformation*

AUTHOR BACKGROUND



EDUCATION

MASTER

Chalmers University of Technology
Architecture and Urban Design
2022-2024

Master studios

- Material and Detail
- Housing Inventions I
- Housing Inventions II

Master courses

- Sustainable development and the design professions
- Architectural competitions
- Design approaches and narratives
- Academic approaches and general structures

BACHELOR

Chalmers University of Technology
2019-2022

Extracurricular courses:

- Rome excursion

TABLE OF CONTENTS

01 Introduction

- 01 Problem statement
- 01 Purpose
- 01 Research question
- 02 Sustainability
- 02 Method
- 03 Delimitations
- 03 Glossary

04 Part one: Theory

- 05 Diverse housing forms
- 05 Social sustainability
- 07 Defining the heritage
- 09 Target group
- 09 Statistics
- 10 Design elements
- 14 Reflection

16 Part two: Context

- 17 Ängagården
- 24 Inventory: Materials
- 26 Inventory: Heritage
- 28 Inventory: Qualities
- 31 Inventory: Entrances
- 33 Analysis: Sun study
- 33 Analysis: Distances
- 34 Reflection

36 Part three: Case studies

- 37 Case study 1: Floorplans
- 54 Case study 2: Transformation
- 56 Reflection
- 57 Sub questions

58 Part four: Design project

- 59 Framework
- 60 Gardens
- 61 Transformation
- 62 Facades & sections
- 64 Detail sections
- 66 Illustrative facades
- 68 Floorplans
- 70 Perspective illustrations
- 72 Furnishability
- 76 Discussion & conclusion

80 Reference list

INTRODUCTION

The design project of this thesis is to transform a farmhouse into a multi-residential community. It is meant to provide a new dwelling alternative in the countryside.

Large farmhouses and acres of land become less and less used for its original purpose as more people move to the city. (Carson et al., 2022). Even though the countryside lacks some aspects of importance, it provides other possibilities that are often not found in the city: cheaper housing, closeness to nature, space, and generally a higher rate of wellbeing. Investigations also show that there are many houses left empty in the countryside (Åkerman, 2020).

Problem statement

In the past decades, centralisation and globalisation has turned a previously active countryside into more of a desolate place that people move away from, to move to the city, leaving behind an abundance of space and empty houses. (Åkerman, 2020)

While in the city, with access to all sorts of public service, more and more people suffer from stress, noise, and pollution. (Cheng et al., 2019)

According to Åkerman (2020) about one third of the Swedish population wishes to live in the countryside, but not as many actually live there for various reasons. These reasons include everything from the size and cost of dwellings, lack of access to public service, distance, or lack of alternative dwellings.

Purpose

The purpose of this thesis is to explore and

develop an alternative dwelling situation by investigating the qualities of how people live today and bringing these qualities together into a design proposal. The aim is that the countryside will remain rural. It shall not become overcrowded like the city, but simply be used to its full potential while keeping the current atmosphere. It is therefore of utmost importance to preserve the cultural heritage of these locations since that is the essence of the Swedish countryside.

The thesis aims to showcase how multi-residential housing can be developed in the countryside and demonstrate that there is a space-efficient alternative to living in the city. It is also a pursuit to make the countryside more attractive to live in. It can be for the smaller household that doesn't have many options in the countryside, or even for people who never before considered living there. This will provide people with an alternative type of dwelling in the countryside, welcoming a new diversity to it.

Research question

The main question of this thesis is:

How can the transformation of large farmhouses in rural Sweden contribute to sustainable development by creating multi-residential communities, while preserving the cultural heritage of these buildings?

As this is a very extensive question, touching upon many different subjects, two sub questions have been formulated to better deal with these areas:

A. How can different design elements be used to accommodate qualitative living standards and multiple dwellings within the dimensions of a Skånelänga farmhouse?

B. What principles of architectural heritage preservation and restoration can guide the transformation process when repurposing the farmhouse, to ensure its unique characteristics and historical significance?

The sub questions are to be considered rather general and small, mostly there to guide the thesis forward. They will be answered through the help of case studies.

Sustainability

By repurposing already existing buildings, environmental sustainability becomes a substantial aspect since a lot of materials and structures will be reused or preserved rather than built new from the ground.

Circularity is central in the project. Reusing the building for a new purpose extends the life length of it. There is also the possibility of the building getting yet a new purpose in the future.

Social sustainability becomes a vital aspect, where sharing space like this will connect people even in rural areas. By establishing shared social spaces, as is very common in city living, there is an opportunity for everyone that wishes to, to connect with others.

This also creates an alternative way of living

in rural areas, giving people more housing options when moving here. This can provide a diverse community in the countryside, making it more accessible and welcoming for everyone.

Method

The method for this thesis is research by design, analysis, and case studies. Each method has been chosen as a tool to move forward in the thesis, to learn and to benefit from different aspects of the work. The thesis will be divided into four main parts: theory, context, case studies, and the design proposal.

The theory will provide an overview of everything from the current housing situation in the countryside, to the history of the farmhouses in southern Sweden. This part is a literature study, where knowledge is gathered to understand important aspects of today's situation. It is also a study of knowledge and approaches that will be important in the other parts, for example, to support the case studies. From the theory part, a framework can be developed to support the work for the design proposal.

The context part will focus on analysing the site, such as weather conditions, daylight, transportation and distances. An inventory will be made to identify qualities on the site today, so decisions of what should be preserved or restored can be made.

The case studies will identify the qualities of households through different types of living typologies, and further, investigate how these qualities can collectively be brought

into the design proposal. It will also explore the relation between old and new, and how they can work together, in different transformation projects, which also will be useful in the final design proposal. The case studies are shaped to provide answers for the sub questions of this thesis.

The design proposal will be developed from what has been learnt from the first three parts of the thesis, capturing the most relevant parts of each, to shape the new dwellings. This part will focus on the design of the farmhouse, and how the dwellings can be organised to optimise the living situation for the homeowners in the residential community.

At the end of each part, a reflection is made about what has been brought up, relevance, and how it will be used in the design. A discussion along with a final conclusion will be made at the end of all four parts, to finalise the thesis and answer the main research question.

Delimitations

This thesis focuses on the possibility of transforming a farmhouse into multi-residential housing, where the main effort lies in the design proposal. Economy or costs in general are excluded in this project.

Structural engineering will be minimised in this project, as the focus will lie on the design and not the construction.

As a big part of the project is about preserving the cultural and architectural heritage, only existing buildings will be used and transformed. Additions or extensions

will be made to strengthen the project and its needs, but no new farmhouse will be made from scratch.

When additions are made, reused material will be used as much as possible.

Statistics and analyses concerning the countryside will be limited to the region of Skåne. This is because the architectural and cultural heritage that this project aims to preserve is specific for this region.

In the design proposal, the chosen site is a farmhouse with a big garden and two agricultural fields. These two fields will be excluded from the project since the focus will be on the housing situation.

All illustrations, photos and figures have been made by me if not stated otherwise.

Glossary

Multi-residential communities: *Several families living in private dwellings within the space of one shared farmhouse.*

Urban area: *According to SCB, any area with coherent buildings, inhabited by more than 200 people, is considered urban area.*

Rural area: *According to SCB, any area with coherent buildings, with less than 200 inhabitants is considered a rural area or a "small locality".*

Skånelänga: *The specific type of farmhouse found in the region of Skåne, in southern Sweden.*

PART ONE

PART ONE: THEORY

Diverse housing forms

Today there are many farmhouses and other structural buildings left abandoned in rural areas of Sweden, many of which are located in Skåne (Åkerman, 2020). The most common housing typology in rural areas are villas or other large single household dwellings (SCB, 2024), such as farmhouses for example, and there is a lack of alternative dwellings in the countryside. This lack of alternatives can easily create a homogenous neighbourhood, which in turn could lead to a more segregated society. If new alternatives were to be added, there is a possibility of creating a more diverse society with inhabitants of different backgrounds and financial statuses.

Even though there is a growing urbanisation, statistics show that this is not necessarily due to people leaving the countryside, but rather because of relocation (for instance moving to the city from another city, or another country), a growing population, and a growing percentage of immigrants. The same statistics show that for the first time in a long time, the population is growing even in the countryside (SCB, 2018).

As mentioned in the background, surveys present that almost one third of the Swedish population wishes to live in the countryside, but the reason why many don't, can in some cases probably be linked back to the lack of alternative dwellings. Åkerman (2020) continues to state that there is a demand for a greater diversity of housing forms, specifically smaller, cheaper, and more simple dwellings.

Social sustainability

"Recognizing the living dimension of historic heritage sites to regenerate and reutilize them in a more sustainable approach, is a useful way to build a sense of community through social interaction and aspects associated with local heritage, as well as promoting community life and a sense of place."

– Citation from Cattaneo et al. (2020)

One way to create a social interaction, and through that be able to build a sense of community, could be to design a housing situation to accommodate a target group with various interests and life situations. This can include age, gender, or family constellation. According to Nocca (2017) a socially diverse dwelling can contribute to social well-being.

Diving deeper into social sustainability, there are many aspects to consider. Gehl (1971) listed eight environmental psychological requirements, all of which she thought needed to be considered if the purpose was for individuals to have a fulfilling and humane living atmosphere:

1. Need for human contact (to see and meet others)

In a residential area, people often meet spontaneously when carrying out their daily tasks, such as taking out the trash, doing laundry, carrying groceries, or going to and from the car or bike. Another time residents meet is when simply living their everyday life, watching kids play, sunbathing, relaxing on the balcony or patio. Gehl (1971)

states that human contact can improve wellbeing, and therefore the design of shared spaces should support the possibility of spontaneous meetings and encourage residents to be social with their neighbours.

2. Need for privacy

Just as human contact is important, the need for privacy is important too. The border between the outside and the inside is a vital factor for establishing privacy, calm and quiet. Here, the size of a residential community plays a big part, as an overcrowded housing condition can easily lack privacy. Too much noise is often connected with overcrowding, which also affects the perceived impression of privacy (or lack thereof).

A way to promote privacy can be to design a residential building with a variety of apartment sizes, making it possible for a family to grow, without necessarily having to leave the residential community. (Gehl, 1971)

3. Need for varied experiences

In a living environment, varied experiences could include nature, mixed-use buildings, several options of transportation, seasonal and temporal structures. All of these can provide a change of pace in an otherwise simple everyday life, and thereby eliminate mundanity (Gehl, 1971).

4. Need for purposefulness

Gehl (1971) describes purposefulness in as a psychological need in a living situation. This need can be met through

hobbies, gardening, maintenance, or the pursuit of learning, for instance. Having a sense of purpose and meaningfulness is strongly connected to wellbeing.

One way to architecturally design for this can be to provide space for gardening, or rooms for creativity, hobbies, or clubs, which can be accessed for all residents that are interested.

5. Need for play

Play can be perceived in different ways, but according to Gehl (1971) it should invoke sensory perception and motor activity, preferably in a creative environment. Play provides people with the choice of how to behave, and freedom to experiment, and should not be limited only to children.

Regarding design for play, it is not enough to just build a playground and nothing else. The play and freedom need to be encouraged, and not interfered with by cars, for example, which is becoming more of a problem in modern society (Peters, 2016). Play should be incorporated in the housing concept as a whole, and not limited to just the outdoor environment.

6. Need for structure and orientation within the environment

Establishing structure and clarity for a better orientation is often done in bigger buildings in cities, with many residents or visitors, to help them recognise and find their way. This is most appreciated by the senior generation, but helpful for everyone. It is commonly used in

healthcare buildings such as hospitals or retirement homes, by for example colour coding, using guiding lights, or creating small landmarks (Gehl, 1971).

7. Need for a sense of ownership and identification with the community and environment

Wellbeing and happiness can be connected to the possibility of affecting and influencing the environment of one's own home and its surroundings. Being able to make it personal is strongly linked to identity and the sense of ownership (Gehl, 1971).

8. Need for aesthetics and beauty

Beauty is definitely a personal taste, difficult to please everyone with. When Gehl (1971) describes architectural aesthetics and beauty, she shows examples of patterns of facades, interiors, and construction details, often combined with variety, order, and harmony.

The needs presented by Gehl centres around social sustainability and the wellbeing of people in a residential building. Peters (2016) evaluates these eight needs, and notes how strongly connected to architecture they are, and yet, how often they are not taken into consideration when a building is developed. While these eight presented needs offer a good starting point, they do not offer a concrete solution since each relevant approach is defined and changed depending on the site (Peters, 2016).

They can act as a good foundation for the design proposal as to how the space should be distributed and designed for

social and private spaces within the farmhouse, as every one of the aspects have their own effect on the building, and most importantly its residents. Taking each of them into consideration when designing can strengthen the social sustainability of the project.

Defining the heritage

As it is the thesis' aim to preserve the architectural heritage, it is first important to understand it. The southern farmhouse is a residential house, often built before 1850, for the agricultural working population of Skåne (Torgny, 1984). Its appearance can vary, but there are some common characteristics for the traditional southern farmhouse.

Torgny (1984) describes in his book *Skånelängor: to understand and preserve a cultural heritage*, how the width of the house is usually no longer than six meters. This is because the roof beams, made from solid logs, usually cannot be found longer than six meters. The length of the house, however, can be three to five times longer than the width. Because of this long, narrow shape, the floorplan gets a rather special layout with all the rooms in a long row. The materials that are used are from the local surroundings and can therefore vary. The roofs can be covered with straw, which is why the angle of the roof should be at least 45° so that rain can run off it without causing damage.

Torgny (1984) continues to describe the layout of the garden surrounding the farmhouse. During the 1800's, there was

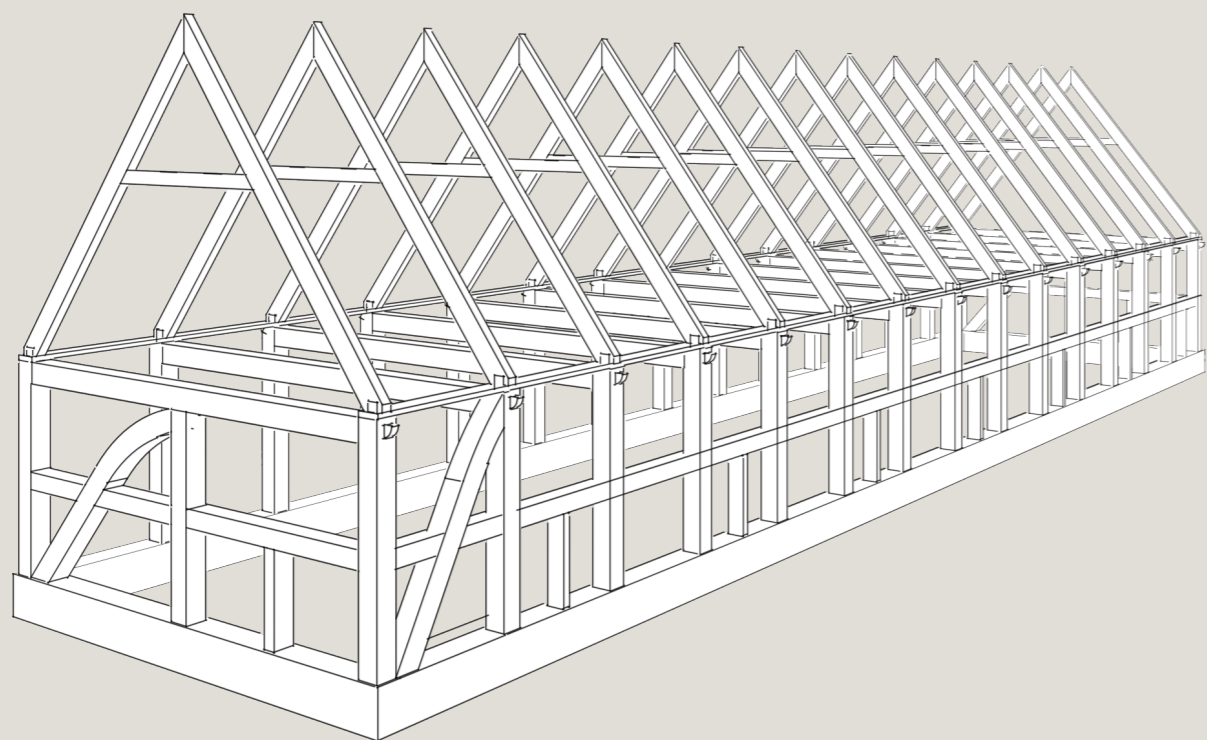

Figure 1.
Typical timber construction of a Skånelänga.
Modeled in SketchUp by me.

usually just a cabbage patch garden, some fruit trees, and a hops garden. But as the farms got richer, the land around them got bigger. As a way to avoid the heavy winds in such a flat landscape, big leaf trees were planted around the farmhouse, together with bushes, and a stone wall, built from the stones and rocks found in the fields.

In front of the entrance, there is a hard surface courtyard, with a circle of grass, framed by a flourishing flower bed. Preferably in the middle, a noble tree is planted – commonly walnut, mulberry, or chestnut (Torgny, 1984).

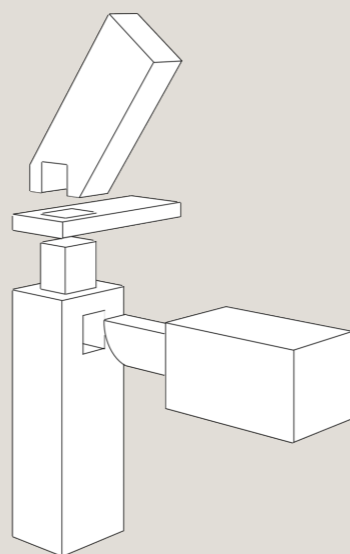

Figure 2.
Detail of the timber joints.
Modeled in SketchUp by me.

Target group

The thesis aims to present a design proposal for a diverse target group. Going back to social sustainability, both Nocca (2017) and Gehl (1971) state that a socially diverse dwelling contributes to wellbeing, which is why this is the target group for the project.

As it is very usual for the farmhouse to have a big courtyard and garden (Torgny, 1984) it is relevant to present a design proposal which makes use of all that outside space. Here, a mixed target group is of good use, as different groups of people or family constellations use the outside space in different ways (Olsson et al., 1997).

Olsson et al. (1997) describes that even though families with children use the courtyard or garden for play and activities, while the senior generation prefer space for calm and quiet, they both crave social interaction and diverse surroundings.

Statistics

As can be seen in the charts to the right, statistics shows a clear increase in villas when leaving the big city (SCB, 2024).

The first chart shows statistics of all of Malmö municipality, including the less dense areas outside the city, but inside the municipality.

Malmö is excluded from the second chart, but there are still smaller cities and communities included, as there are no statistics for only rural areas. This indicates that the increase of villas in the countryside is presumably even bigger than the statistics show.

Buildings, Malmö

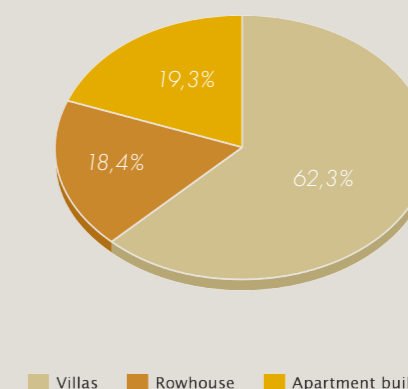

Figure 3.
Pie chart of building typologies in Malmö.
Data collected from SCB, 2024.

Buildings, Skåne excl. Malmö

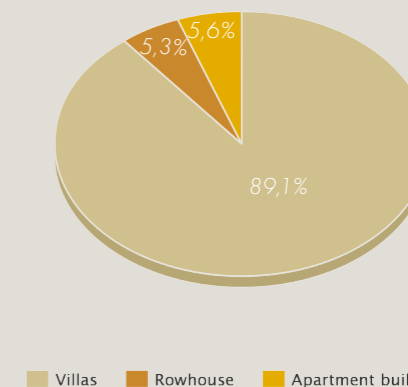

Figure 4.
Pie chart of building typologies in Skåne.
Data collected from SCB, 2024.

Design elements

When designing a home, there are many elements that can be taken into consideration, and strategies to use to get there. These are things that can heighten the living quality for residents, as well as to guide the designer in the drawing process of a housing situation.

Nylander and Forshed (2011) describe seven different design elements that contribute to architectural quality within housing. These elements are a set of different design methods, traits, and attributes that can offer value in the experience of the dwelling, such as usable space or aesthetics, for the resident. The seven elements are described as follows:

Material and detail

Craftmanship and qualitative materials play a significant part in the experience of a home. Resilience, maintenance, and aging are important factors to consider when designing housing of good standards. This is strengthened by details, such as a seamless meeting between two materials, or an ornamental element in the structure. (Nylander & Forshed, 2011)

Carefully selected materials and craftmanship can help the resident to experience the attention to detail, which in extension can help them identify more with their home. For the resident to identify with their home can be seen as equivalent to experiencing a meaningfulness, it makes them feel a stronger connection to their home. (Nylander, 1998)



Figure 5.
Icon for Material and detail.

Axiality

During the city planning of the Roman Empire, axiality and symmetry were prominent features. A direction towards something was often common. Where two axes meet, the architectural experience intensify. This can serve as a way of understanding the hierarchy and importance of rooms in a building (Nylander & Forshed, 2011), which is probably why this strategy is still used today.

Key factors for axiality include length, the number of rooms the axis crosses, symmetry, and the outline of openings along its path. It often has a clear start and end point. A qualitative axiality serves to unite important areas of the dwelling, and provide good sightlines and outlooks. (Nylander, 1998)

Enclosure/openness

The terms enclosure and openness are two characteristics that are important for the experience of a room. Openness refers to the openings of a wall, such as the doorway or windows, and enclosure refers to the wall itself. It is important to not only work with one of these features, as the relation between them is important. The size, placement and appearances of the openings help determine the character of the room. (Nylander & Forshed, 2011)

Briefly put, enclosure can create the feeling of safety and privacy, while openness instead can create a sense of freedom and opportunities for social interaction. Both of these are important aspects and qualities to obtain in a home. (Nylander, 1998)

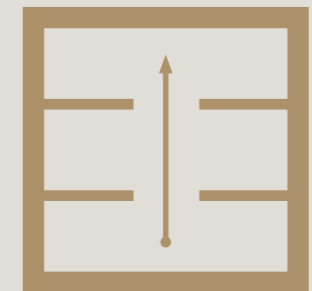

Figure 6.
Icon for Axiality.



Figure 7.
Icon for Enclosure/openness.

Movement

The residents' perception of a room is deeply connected to movement in it, and through it. Movement allows other elements, such as size, daylight, and axiality, to be experienced and appreciated. It is also determined by it, directing and guiding the flow of movement through the residence. (Nylander, 1998)

Circular movement is a quality that allows the resident to experience rooms, both individually, and in sequence. The functionality of a room also affects the movement – is it a dynamic room or a static room? Some rooms are designed to stay in, while others are more inclined to encourage a flow of movement. (Nylander & Forshed, 2011)

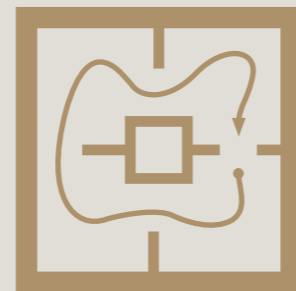

Figure 8.
Icon for Movement.

Generality

The general room can contain many different functions with the possibility to furnish in different ways. The idea is to give the resident the opportunity to choose how it is to be used, as opposed to kitchens, bathrooms, or bedrooms, that all have a specific function. (Nylander & Forshed, 2011)

The dimensions of the general room are bigger than the bedroom, yet smaller than the living room. The size, placement, and number of openings of the room decides its generality, and through that, provides a certain flexibility for how it can be used, and which needs that can be met. (Nylander & Forshed, 2011)

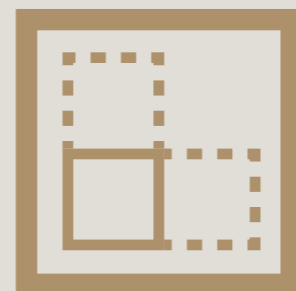

Figure 9.
Icon for Generality.

Daylight

Natural light in a home is an important quality, especially in Scandinavia, where the winters are dark and long. Daylight can be used in different ways, in different amounts, as a way to control the atmosphere for each individual room. As an example, more light in a living room can contribute to the feeling of openness and spaciousness, while in a bedroom it might be more preferred to have a less light, making it cozier and more intimate. (Nylander & Forshed, 2011)

Daylight has the ability to enhance the experience of axiality, openness and movement in a home, as well as establishing a destination. (Nylander, 1998)

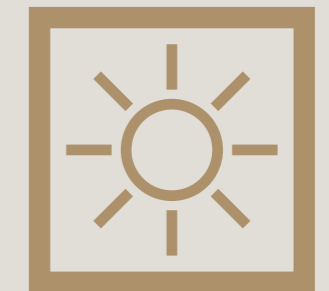

Figure 10.
Icon for Daylight.

Room organisation

An important part of housing is the division of private and social areas, and how they meet. This can be designed in different ways, with the most common strategies being: *central room plan*, *function & installment plan*, *corridor plan*, *middle-part plan*, and *zoned plan*. (Nylander & Forshed, 2011)

The meeting between the indoor and outdoor is just as important. How the private dwelling meets the public outside, where the entrance is placed, and if there is a mixed zone as a transition between the two. (Nylander, 1998)

How the rooms are placed, and the movement through them, can be mapped with the help of a space-syntax graph, where the rooms are represented as nodes, and the doorways as links between them. (Hillier et al. 1987)

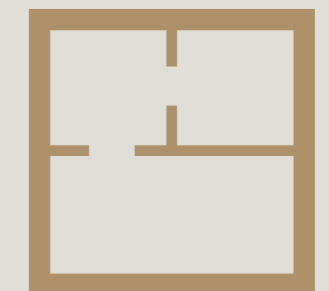

Figure 11.
Icon for Room organisation.

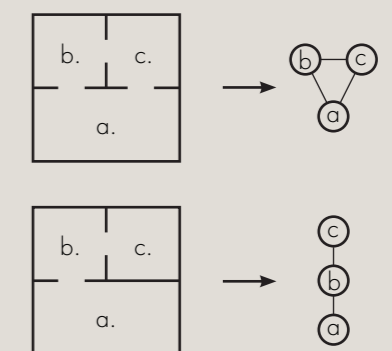

Figure 12.
Space-syntax diagram of room organisation.

Theory: **Reflection**

This first part is the foundation for the thesis and the design project. What has been brought up here are things I find valuable in a project in general, and things I will bring into the design project.

When narrowing in on a specific area such as Skåne, combined with a specific typology, I found it difficult to obtain multiple sources or references, making parts of the theory a bit one-sided. I have tried to bring in as many aspects of the theory as possible, to make it more credible, but in some cases it is still lacking. Knowing this, I still think it can bring value to the thesis, or at least shed light on the fact that the area of study in general is lacking.

The eight needs presented by Gehl offer a great view into social sustainability and what is important to consider when designing a multi-residential community. I use these as guidelines in the design project, especially when developing the outdoor space and shared areas.

Going deeper into this, I believe some of the needs are more relevant than others when it comes to the specific design project of the farmhouse. For instance, *varied experiences* and *orientation within the environment* both seem to be more fit for a lot larger or more public building, with a higher flow of people and activities happening in the nearby surroundings, causing orientation to be of great help. Of course, they are still good to consider, but the other needs I think are more valuable in a smaller community.

For example, regarding privacy, it was stated that overcrowding can be an issue, and that a variation in dwelling sizes can promote privacy. Both these aspects lead me to believe that the farmhouse should not contain too many dwellings, but still enough to create a community with a variety of family constellations and dwelling sizes, resulting in a diverse target group which was also stated to promote wellbeing.

When it comes to the design elements, there are countless numbers of elements to consider depending on how you view them. I choose to bring forward the seven design elements presented by Nylander and Forshed, since I think they offer a good and varied overview of different possible elements to use. Of these seven, I bring four of them (*axiality, movement, daylight, and room organisation*) with me into the case studies because I consider them more strongly connected to floorplans, which is what that specific case study is about.

I still have the other elements in mind when designing the final project, but they might not always be as prominent. *Material & detail* will for instance be more connected to the heritage in my project. And *generality* can be found and connected back to social sustainability and flexible rooms, which can be a good design element when, for example, creating space for play indoors.

The space-syntax diagram that was presented together with the room organisation is a form of mapping I use to all floorplans in this thesis as a way to give an

overview of how all rooms are connected, how the movement through rooms and social/private areas are made. It is also a way of defining different design strategies connected to room organisation, which is why I think it is relevant to display together with each floorplan.

PART TWO

PART TWO: CONTEXT

Ängagården

The project site chosen for this thesis is called Ängagården. It is located in Vellinge municipality in the south of Sweden, about 20 km south of Malmö. The farmhouse was built in the late 1800s, and later renovated in the '90s by the current owner.

This site has been chosen mainly because of a personal connection to the farmhouse, which has provided me with free access to it, both inside and outside, as well as the drawings of the farmhouse from its latest renovation.

Of the 530 m² built area, only about one third of it is actively being used today by the current owner. Living here alone at an old age makes it more and more difficult for her to single handedly take care of the farmhouse and keep it running smoothly.

Belonging to the farmhouse, there are a few acres of agricultural land. These will be excluded from the project as the focus will lie on the housing situation and how that can change and be developed.

The following six pages are plans, sections and facades of what the farmhouse looks like today. After that, an inventory and site analysis is made, as a way to better understand the chosen site.

Ängagården is introduced this early in the thesis as it will be used as a frame for one of the case studies in Part 3.

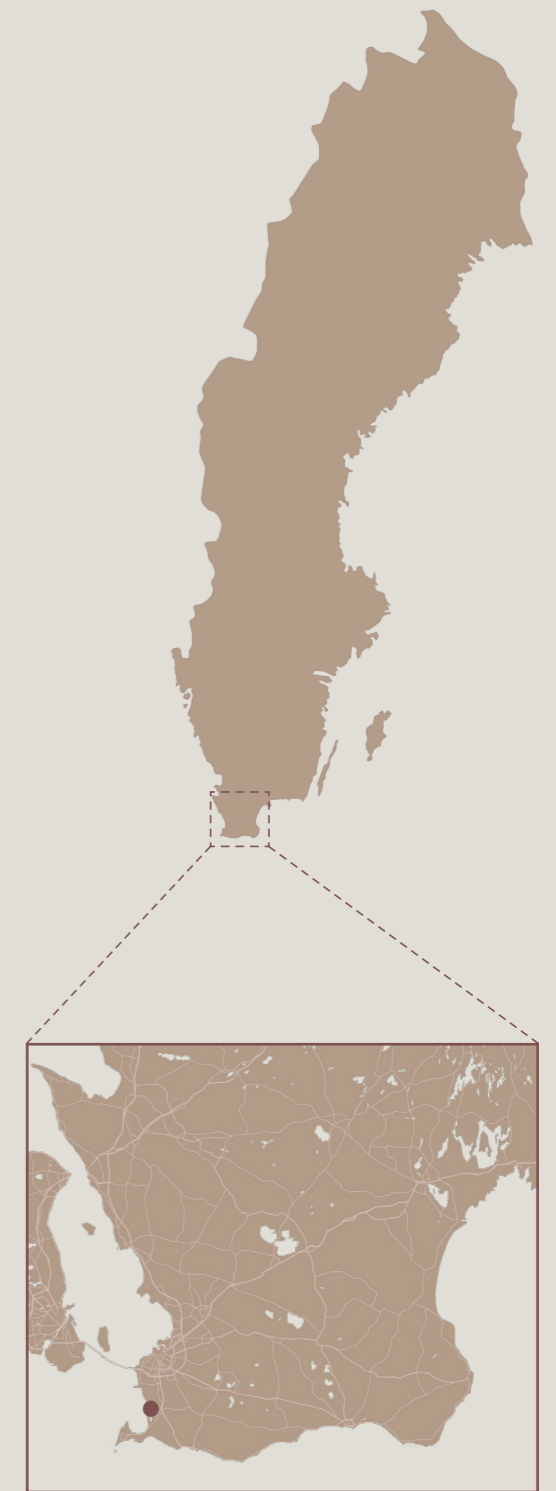

Figure 13.
Map of Sweden, zoomed into Skåne, with the site marked.



Figure 14.
Plan
Scale 1:400

Areas

- BTA: 813 m²
- BOA: 429 m²
- BIA: 351 m²
- BYA: 530 m²
- Plot: 5954 m²

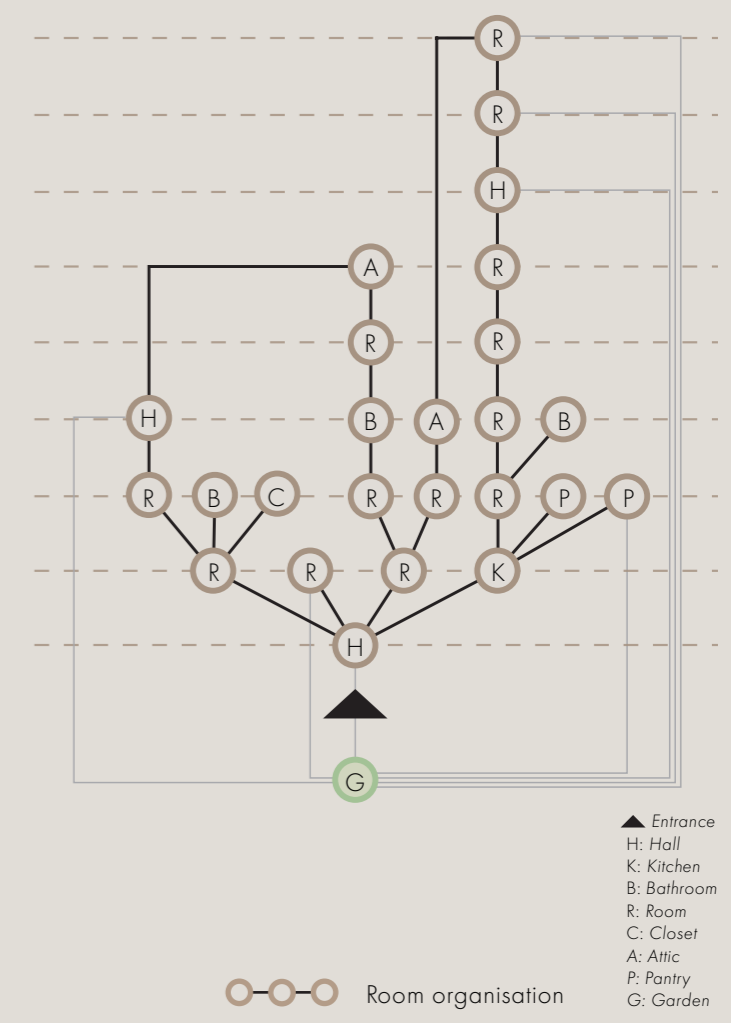

- ▲ Entrance
- H: Hall
- K: Kitchen
- B: Bathroom
- R: Room
- C: Closet
- A: Attic
- P: Pantry
- G: Garden

○—○—○ Room organisation

Figure 15.
Space-syntax diagram of the farmhouse.

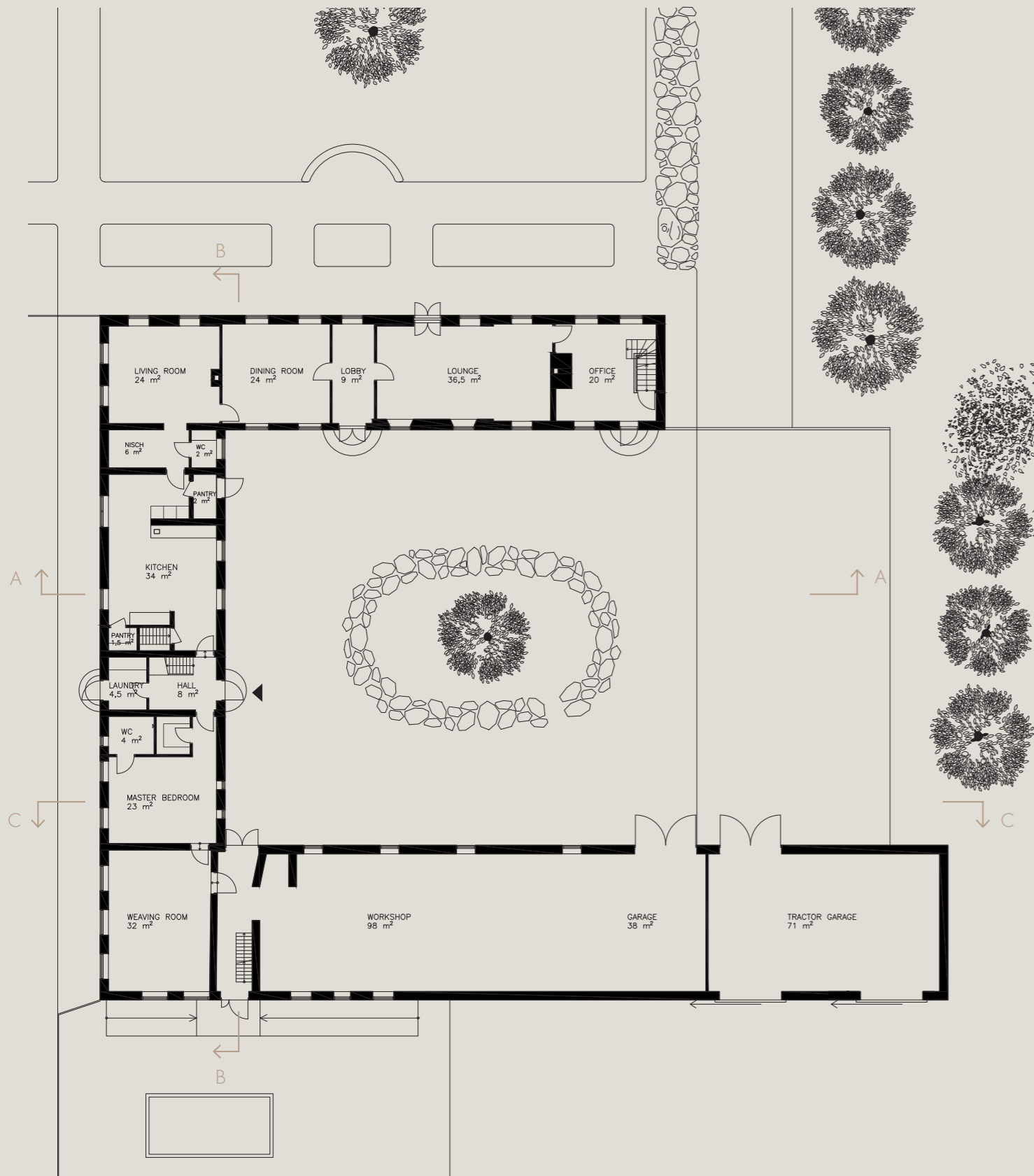

Figure 16.
Plan, entrance floor
Scale 1:250

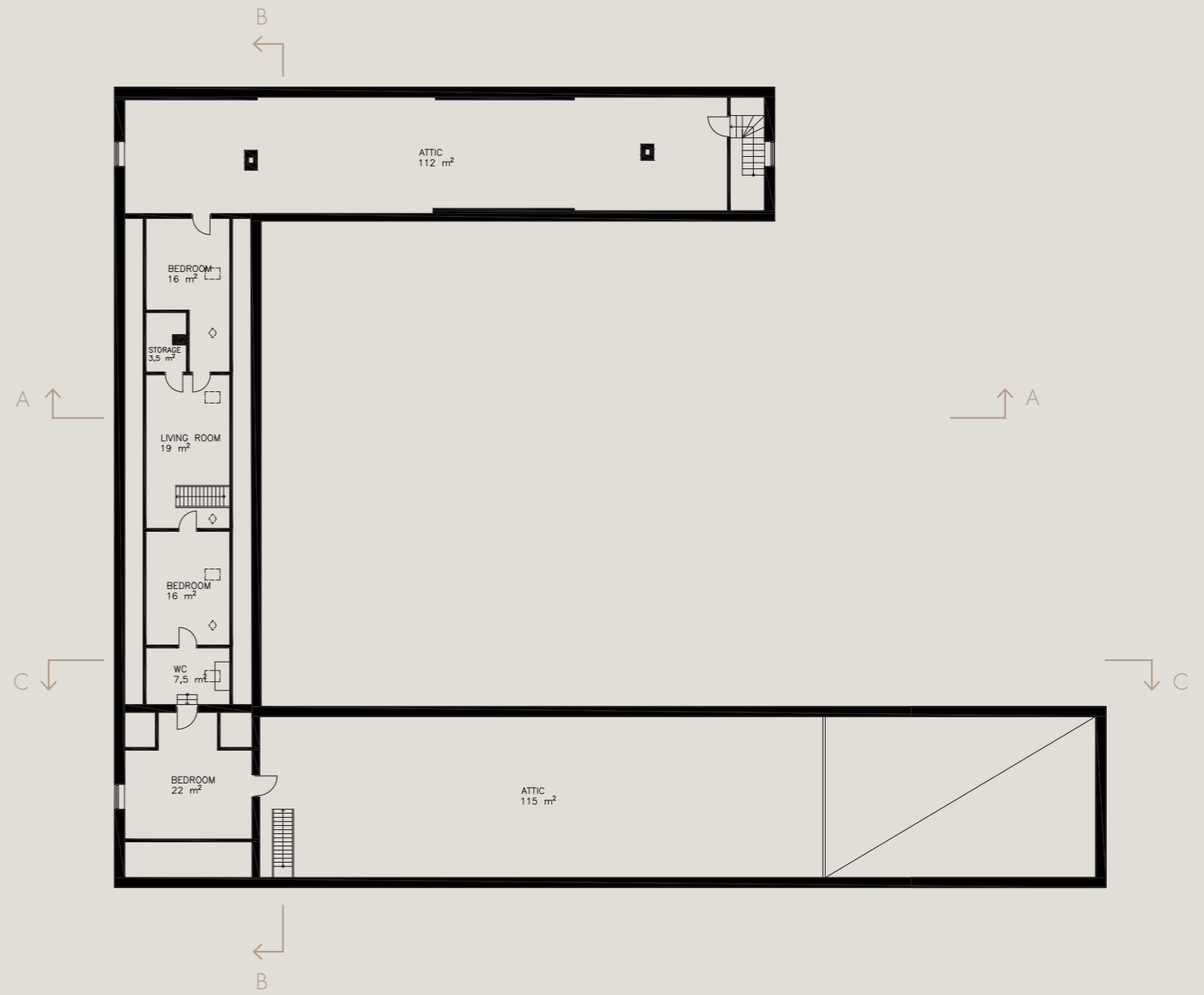
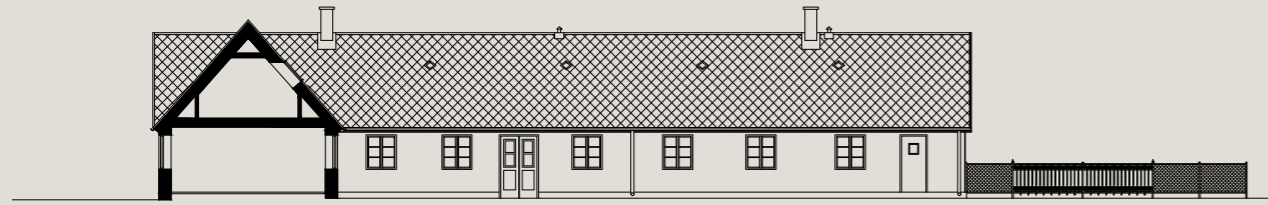
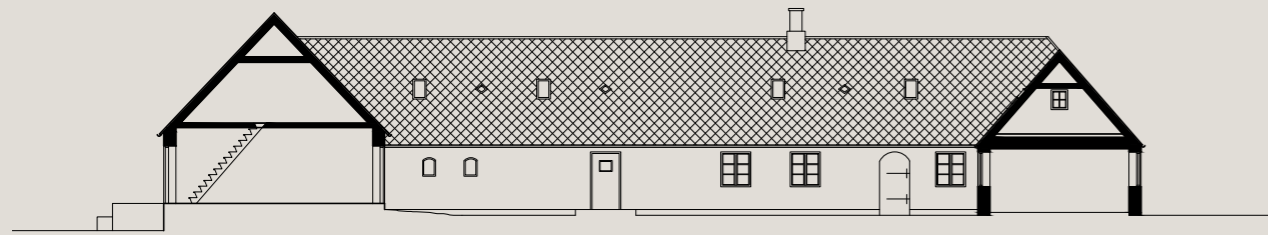

Figure 17.
Plan, floor 2
Scale 1:250



Section A-A Courtyard façade towards south



Section B-B Courtyard façade towards east Section B-B

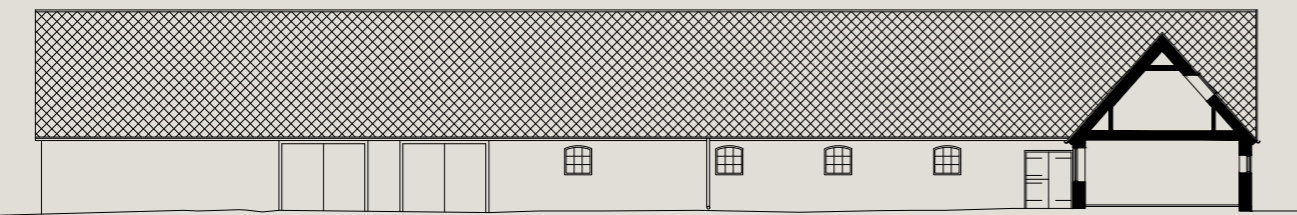

Courtyard façade towards north Section C-C

Figure 18-20.
Facades and sections
Scale 1:250

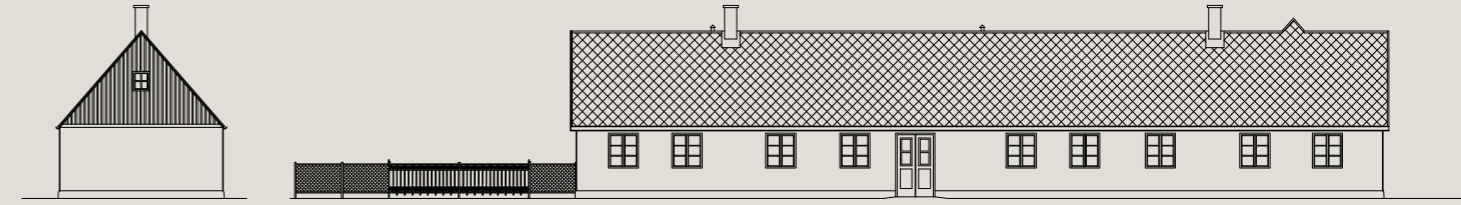

Gabel façade towards east Façade towards north

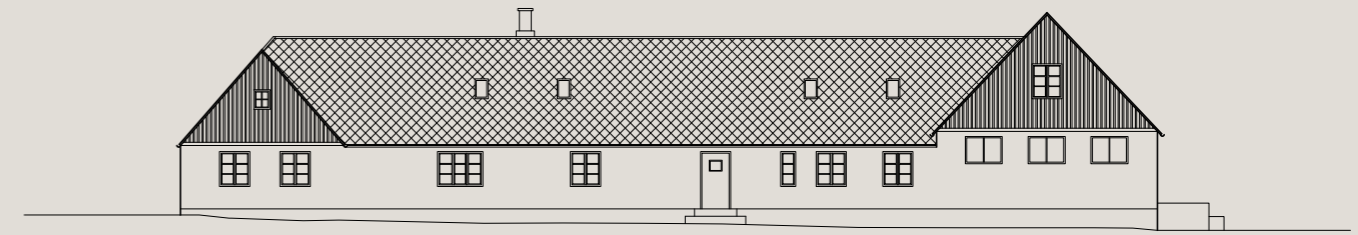

Façade towards west

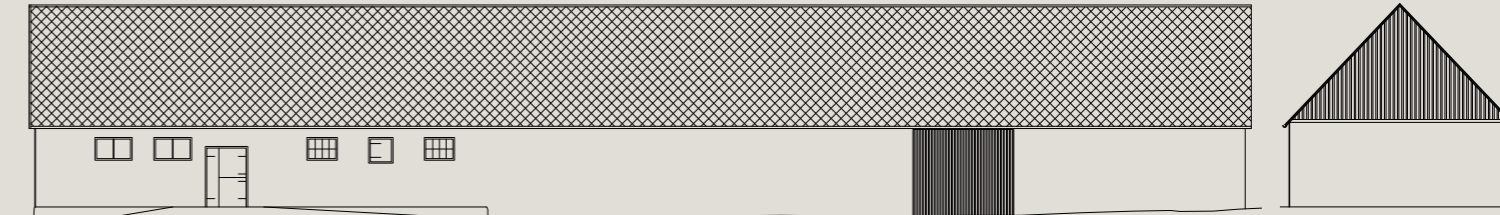

Façade towards south Gabel façade towards east

Figure 21-23.
Facades and sections
Scale 1:250



Inventory: **Materials**

Figure 24.*

Displayed in this photo is the timber construction, visible during the renovation in the 90's. Only a few of them remain visible today, on the northern wing, while the others are covered with cladding.



Figure 25.*

Between the timber is a thick layer of bricks, which then is covered with white cladding. As mentioned above, most of the timber is covered as well.



Figure 26.*

As seen in this photo, the base consists of stones, which was later covered in dark grey cladding. Seeing these base stones exposed indicates that there is no timbered base that carries the weight of the building.



Figure 27.*

The roof is covered in shingled roof felt.



Figure 28.*

The inner courtyard is mainly set in stone (except for a centrally placed patch of grass with a walnut tree, framed by flower beds). Presumably, these stones have been found in the surrounding area.



Figure 29.*

Typical for the Skånelånga is to use materials from the surrounding area. In this photo, a pile of rocks and boulders can be seen, which was later used in the stone wall around the garden.

*All photographs in this spread are taken by Lillemor Eklund, 1990.

Inventory: **Heritage**



Figure 30.

Throughout the farmhouse, several beautiful craftsmanship details can be found in both iron and wood.



Figure 31.

In the set stone on the courtyard ground, there are old milling stones set there as well. These were previously used to turn grain into flour when the agriculture was not as industrialised as it is today. Now it is purely a historical decoration on the ground.



Figure 32.

This simple structure has previously been used to bind horses, when the farm was home to livestock. Even though the farmhouse has not been home to animals associated with agriculture for decades, this wooden beam has stayed put.



Figure 33-37.

Very typical for the southern farmhouses is the visible roof beams. These can be found everywhere in the the farmhouse, some of which are painted, and some remain natural. The majority of them have been preserved, possibly since the 1800s, but a few of them were put in new during the renovation. The newer ones, made of pine wood, are not as rough and bulky as the old ones that are made of oak tree.

Inventory: **Qualities**



Figure 38-40.

Axiality can be found in many places throughout the farmhouse. This is very common as the rooms are placed after each other as links. This is a nice quality as it allows direction and movement in the home. In most rooms, it also allows sunlight to come in through two sides, and openings in the facades can give axiality in the short directions as well.



Figure 41.

The gazebo is a common sight in the garden of a southern farmhouse. It is a great place to take a break from the everyday-chores or to enjoy a cup of coffee.



Figure 42.

The large garden can be a great quality since there is much space to use for everything from gardening, cultivation, activities or play. But of course, with this comes also the matter of maintenance.



Figure 43.

Søstragången – “The sister’s path” is an opening in the stone wall surrounding the garden, welcoming visitors to the farmhouse from another direction than the main entrance. It is a sign of hospitality and community.



Entrance A



Entrance B



Entrance C



Entrance D



Entrance E



Entrance F

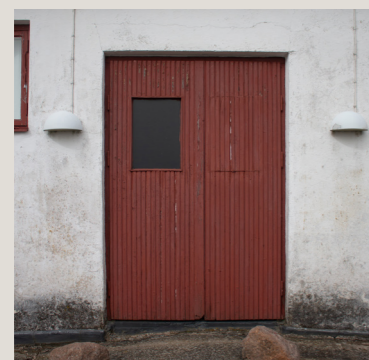

Entrance G



Entrance H



Entrance I



Entrance J



Entrance K



Entrance L

Figure 44-55.
All entrances to the farmhouse

Inventory: Entrances

There are a total of 12 entrances in the farmhouse. *Entrance A* is the one being used daily as the main entrance as this leads to the most commonly used living quarters.

In three places there are openings in both directions, creating an axiality through the building (*A to F*, *G to L*, and *H to J*) which is a quality that allows flow, movement, and sightlines from one side of the farmhouse to the other.

The quality and level of detail of the doors themselves varies a bit. *Door C* and *E* have a much more detailed expression, and are quite well preserved. *Door B*, though not quite as detailed, has a very unique and

industrial expression as it is made of iron. When visiting the site, it was clear that these doors were more cared for, whereas other doors, that are less eye-catching, carried a more worn-out look.

The massive sliding doors in the tractor garage, *door H* and *I*, are quite impressive to behold. Even though their design is simple, the size of them covers the entire facade, and moving them feels like moving the walls.

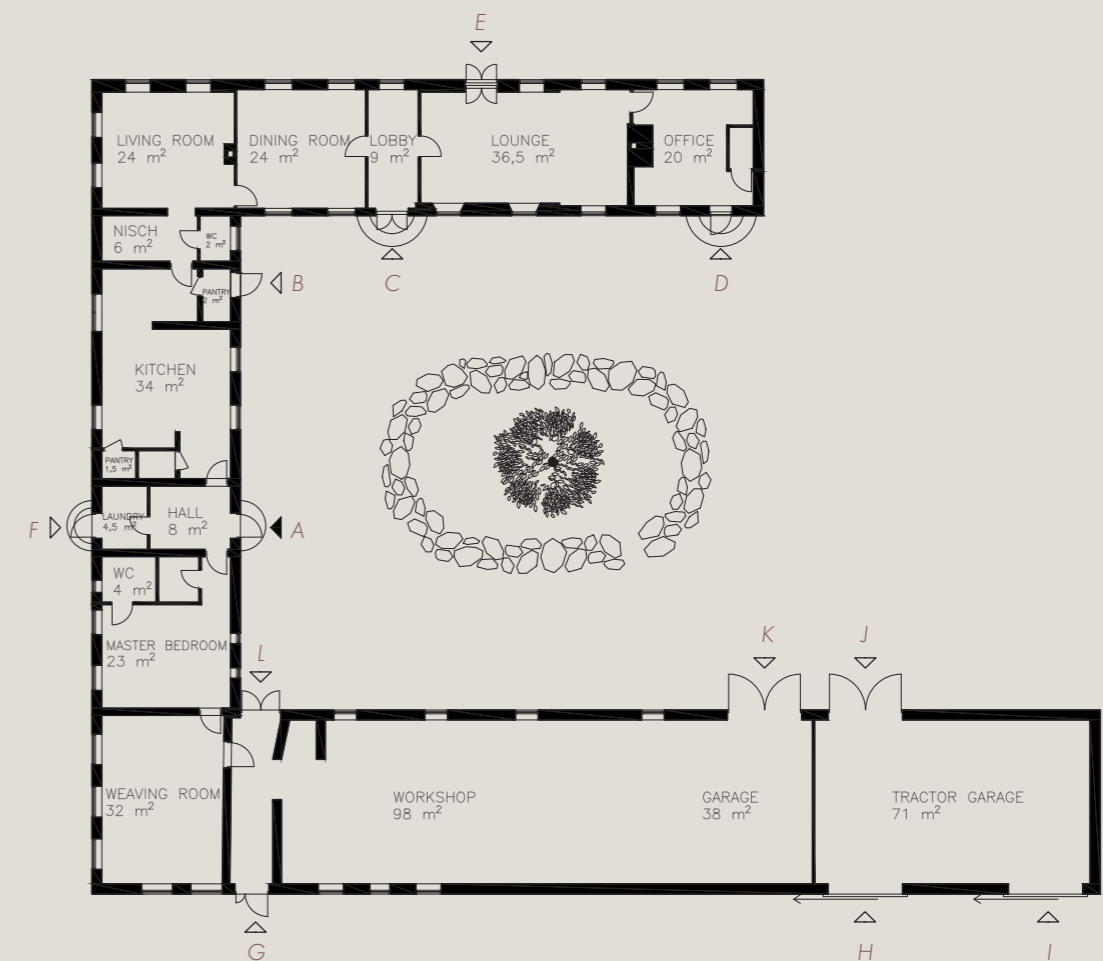

Figure 56.
Floorplan with all entrances marked.

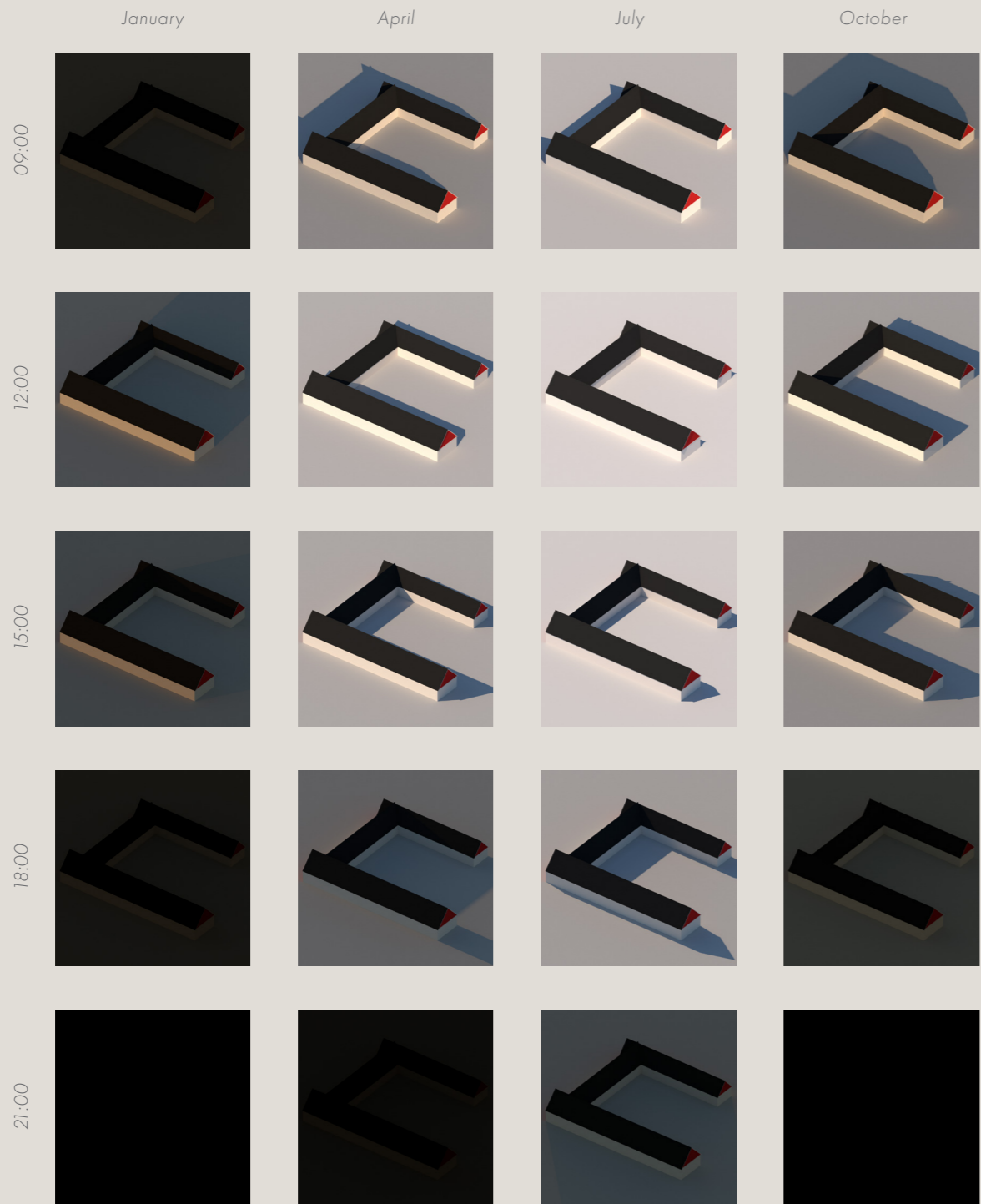

Figure 57. Illustrations of the sunlight during the day and year.

Analysis: Sun study

To the left is a simple overview of how the sun meets the farmhouse throughout the year and the day.

The open end of the farmhouse allows the courtyard to meet the morning sun, while the other side towards the garden gets soaked in the evening sun. However, as the height of the building is relatively low, and the garden big, there is quite a lot of sunlight regardless of where you are during the day.

It is only during the winter months, when the Scandinavian sun is much lower, that the shadows take up much more space.

The middle wing of the farmhouse, the part of it that is most used, is directed towards east-west with the western side in a small tilt towards north. This is the most common direction to build these farmhouses in, as it allows the evening sun to warm up the building most efficiently (Torgny, 1984)

Analysis: Distances

As the farmhouse is situated in a rural area, there is often a long distance to places that people in general need to visit in their everyday life.

The terrain of Skåne is known to be very flat, and this site is no exception. There are no big hills anywhere near the site, making the

surrounding area very accessible by bike. However, bike is not always the best option for certain activities or visits, especially not during winter when snow rests on the ground and the southern winds are strong. A car can therefore be good to have access to.

The following is a list of distances to important places, divided into categories, for a functioning everyday life:

Daily necessities

- 260 m to nearest neighbour
- 2,6 km to nearest bus stop
- 3,2 km to nearest grocery store
- 3,2 km to nearest local centre
- 16 km to nearest big city (Malmö)

Healthcare

- 2,5 km to nearest medical centre
- 2,5 km to nearest dentist
- 7,2 km to nearest vet
- 16,8 km to nearest hospital

Education

- 2,9 km to nearest pre-school
- 4,3 km to nearest school (grade 1-9)
- 3,2 km to nearest high school (gymnasium)

In summary, living in this farmhouse would most likely require the resident to have access to some means of transportation for a functioning everyday life, since a lot of other places are far away.



Figure 58. Map of Ängagården and a selection of the distances to Vellinge C.

Context: **Reflection**

Ängagården is a large farmhouse, with an even larger garden. It is a big project and I constantly find new things to investigate and work with. During this work I have tried to limit myself in order to bring forward the most important aspects for the project, which is being presented in the thesis.

When doing the inventory, even with free access to the site and with plans and drawings of the farmhouse, I found it extremely difficult to find out what materials had been used to build it, and how the construction was made. It is a shame that so much of the construction was covered with cladding since it is a very impressive and historical technique that was used to build this. This is something I bring with me in the design project - I want to make the construction more visible, as it is a big part of the heritage.

Other characteristics and qualities that have been identified throughout the inventory phase are all things I aim to preserve – rooms in a long row that create axiality, windows or doors opposite each other (creating both axiality and a flow of movement between indoors and outdoors), craftsmanship, and historical details. A starting point will be to try to remove as little as possible, but if something needs to be removed, I will aim to find a new place for it, unless it is in too bad condition to be reused. One strategy that I take with me from this is to keep windows in two directions in all social rooms.

When it comes to reusing materials, another approach I will have is to reuse materials as much as possible even in new additions to

the farmhouse. Sustainability is an important factor in this project, and I want to make that statement clear.

Regarding the entrances, these too will be preserved as much as possible. They are evenly spread out around the farmhouse, giving good placements for entrances to the individual dwellings. Some of the doors are placed opposite each other, creating a nice axiality across the farmhouse. I think this is a very good quality and know from experience how nice it is to open them both and let the summer breeze fly through. This is something I want to implement more of in the design project.

The north and west wing of the farmhouse are today very well adapted for housing. The south wing, however, is today not designed for living, which is very clear when looking at floorplan, window placement and the size of them, as well as the type of doors used. This wing is uninsulated, dark and spacious. It will need quite a bit more work than the other wings, so more interventions will be made here, and other windows and doors will have to be put in place.

Looking at the sun study, the west wing of the farmhouse, which is most used, is the side with the most sun. Both the sunrise and sunset are allowed into the housing quarters. This is a wonderful quality for the farmhouse today. But when all wings become inhabited, the north and the south wing will not have as qualitative daylight as the west wing. There is not that much to be done about this, since the farmhouse is where it is. But what I will be working with here is instead the outdoor space, which will

mostly be soaked in sunlight in all directions, since there is nothing around it to cover the sun. The only thing around to cast a shadow is the farmhouse itself, but it is relatively low, so there will still be a lot of sun to be found.

When it comes to the location and the distance to other places, I have been going back and forth a lot on how to deal with this. Originally, I wanted to create a dwelling where the residents would not need a car to live there. But given how far away everything is, even the bus stop, it seems almost impossible. The thought of having a carpool has been explored several times, but assuming that all residents have jobs they need to go to everyday, (or if not, they still need to go grocery shopping, etc.) I think it would be difficult to coordinate so that everyone gets where they are supposed to be. Even if some would be able to drive together, this is not something that can be guaranteed to work for everyone. Instead, I think it is better to make room for at least one car for every family, but leave it up to them if they really need a car, or if they can share somehow.

Using a bike is definitely a nice option since it is pretty much flat everywhere. But the winds can be quite strong here, and during winter I don't think that many people will voluntarily use a bike. Had there been a bus stop closer to the site, it would have been easier to get by without a car, but as it is now, I think it is a necessity.

PART THREE

PART THREE: CASE STUDIES

There will be two case studies done in this part, each with their own purpose. The first case study will be focusing on the floorplans of dwellings of different typologies. The second study will deal with renovation projects, where the purpose is to identify what is preserved and what is modernised in each project. A reflection of both case studies will be done in the end of Part 3, as well as a discussion and conclusion regarding the sub questions of the thesis.

Case study 1: Floorplans

Four typologies have been chosen for this study, all of which have different sizes and functions. These typologies are:

- Rowhouse
- Summerhouse/cabin
- Attefallshus
- Container home

The criteria used when the reference projects have been chosen have been to find different room organisations, qualities, and that the width of the dwelling shall not exceed six meters. These criteria were chosen as the room organisation in the southern farmhouses are often rather strict, and due to the narrow house body, it will be a challenge to fit the bigger floorplans within the limited width of the farmhouse.

The purpose of this case study is to find strategies and qualities in narrow dwellings. Therefore, when studying the reference projects, the design elements that was presented in Part 1 will be the foundation

of the analysis. However, as the case study focuses on narrow floorplan solutions, only the following elements will be considered:

- Axiality
- Movement
- Daylight
- Room organisation

After each reference project has been examined, a design exploration will be done, where the floorplan of the reference project will be crossed with the floor plan of the farmhouse. This is to see how each floorplan can realistically look within the given measurements of the farmhouse. This will hopefully give an insight in what strategies and approaches are suitable to use when going forward with the design project.

Case study 2: Transformation

Three reference projects have been chosen for this study, all of which have undergone some form of renovation and preservation. The focus will lie on what has been added as well as preserved, and *how*.

The criteria used to choose the projects in this study was interesting solutions, both technically and visually. This study is mostly an inspirational one, a way to identify different approaches and the outcome of them. It is a smaller study meant to encourage new ideas and possibilities.

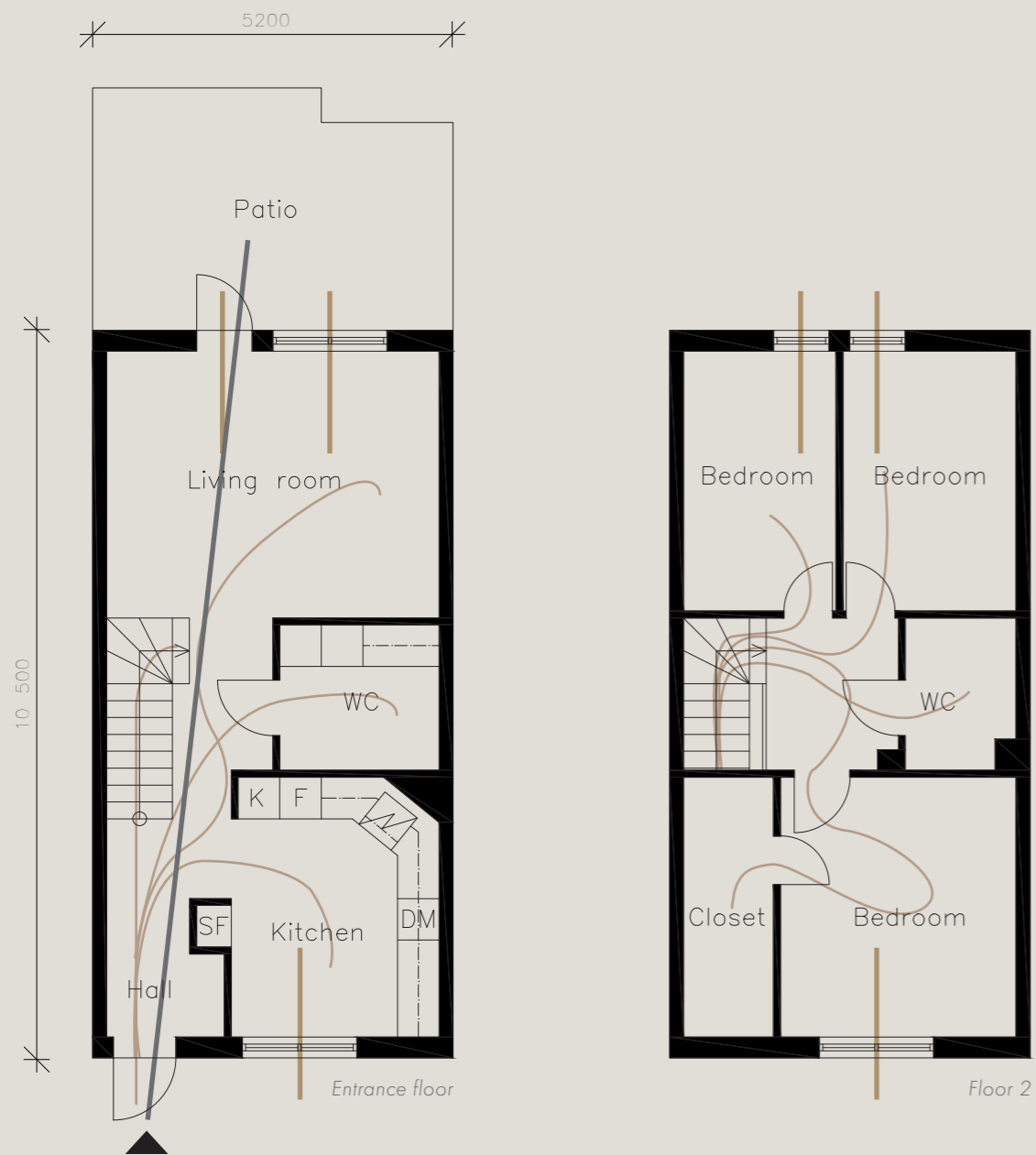

Figure 58.
Floorplan
Scale 1:100 (A4)



CASE STUDY 1 FLOORPLANS

Reference project 1: Dammluckevägen
Typology: Rowhouse
Area: 94 m²
Rooms: 4

General qualities

The first reference project is a rowhouse with four rooms, located in Landvetter.

There are no major sightlines or axes in this reference project, other than from the hall to the living room and out towards the patio.

Daylight comes in through the short ends of the rowhouse, giving it a dark core in the middle. Even though there is daylight from two directions, they do not go through the entire dwelling, resulting in each room still just getting daylight from one direction.

Looking at the room organisation chart, there is a clear division of the rooms, where each floor has a central hall that leads to all other rooms. Having this central hall somewhat limits the movement in the dwelling, forcing the residents to always pass through the hall when going to another room. There are no alternative paths to walk between the rooms.

The rowhouse is well divided into private and social zones, where the social kitchen and the living room are downstairs, while the

private bedrooms are all gathered upstairs.

Looking at the room sizes, they are staying close to the minimum area, keeping the total area down for the rowhouse, however, also making it less furnishable and flexible. If a family of four were to live here, the entrance hall, as well as the kitchen, could become quite crowded. Having two bathrooms, however, is a nice quality.

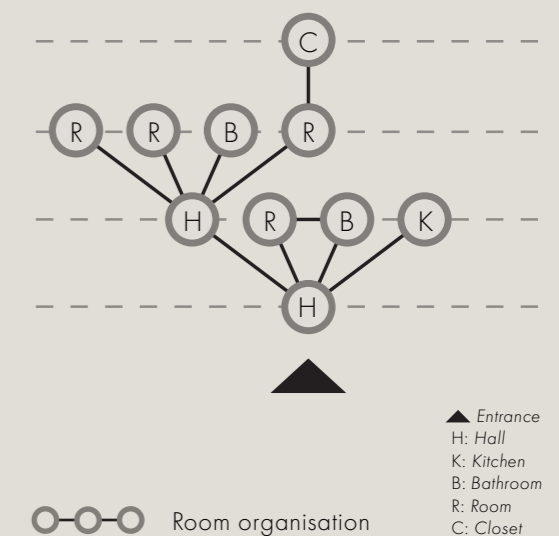
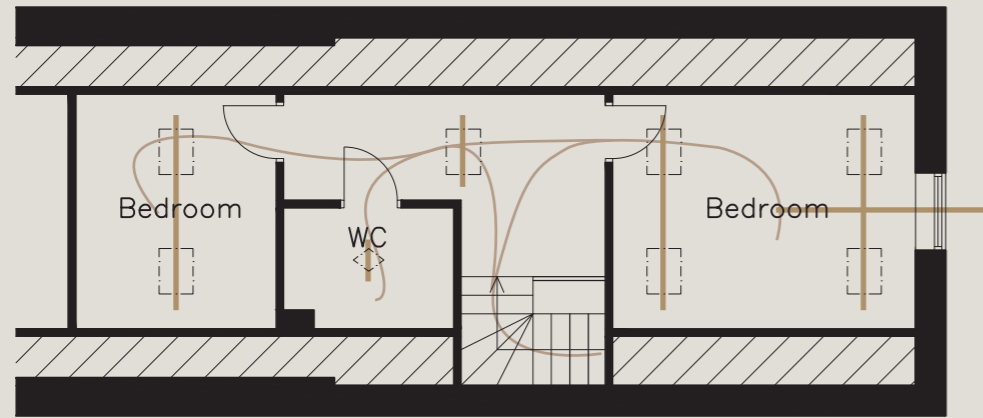
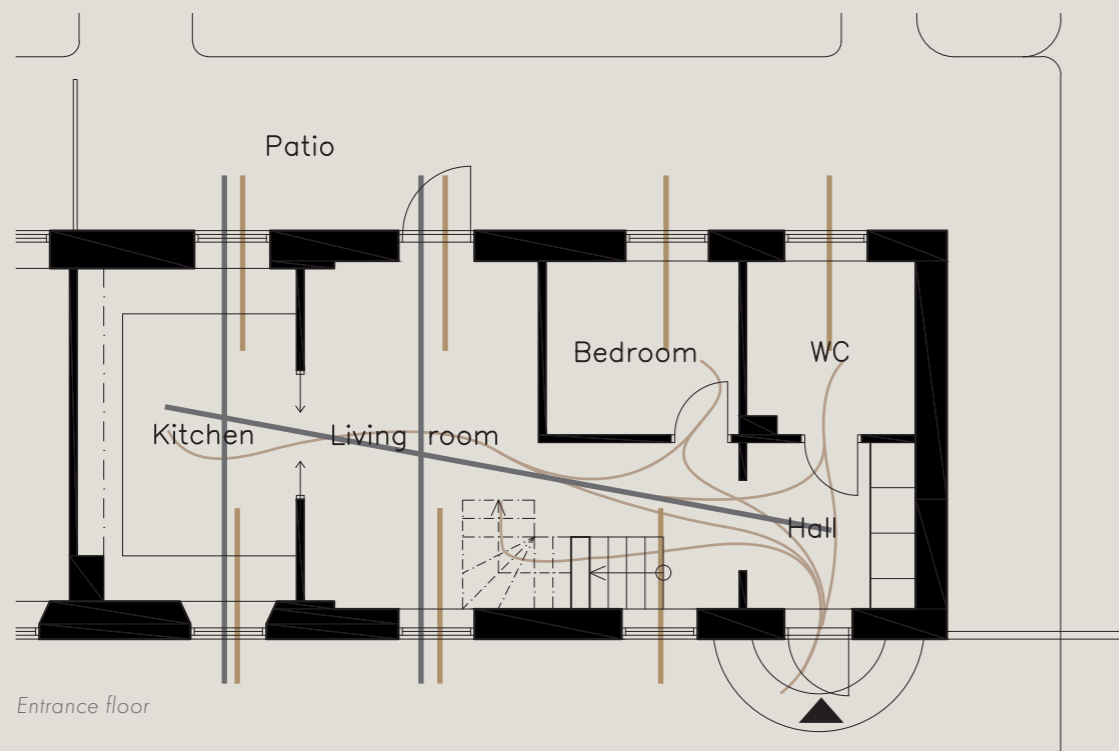

Figure 59.
Space-syntax diagram of the reference project.



Floor 2



Entrance floor

Figure 60.

Floorplan
Scale 1:100 (A4)



- Axiality
- Movement
- Daylight

CASE STUDY 1 FLOORPLANS

Crossover: Reference project 1

When making this crossover, the rowhouse was placed in the northeast wing of the farmhouse, where the width measurements were most similar, and then adapted to fit within its boundaries.

The windows in the farmhouse are placed along the long side, opposed to the rowhouse that has its windows on the short ends. As the windows needed to be shifted in the new floorplan, the aim in this reference project crossover was to keep the room organisation as close to the original as possible. This was achieved by having a central room on each floor, connected to all other rooms in the dwelling.

The new window placement opens up for more daylight and eliminates the dark core that was found in the rowhouse. It even allows daylight to enter from two direction in both the living room and the kitchen, a quality that could not be found in the rowhouse. However, as there are only windows in the ceiling on the upper floor, even if there is daylight there is no view, except in the master bedroom. This can of course be considered less of a quality.

The axiality across the entire dwelling that was found in the rowhouse is also present

in this new floorplan, stretching through both the living room and the kitchen.

The area of the living room in this proposal is a bit smaller than in the rowhouse, as it had to give space to the bedroom. This is because the upper floor is so narrow that it was tricky to fit all three bedrooms up there without having to compromise either size or privacy.

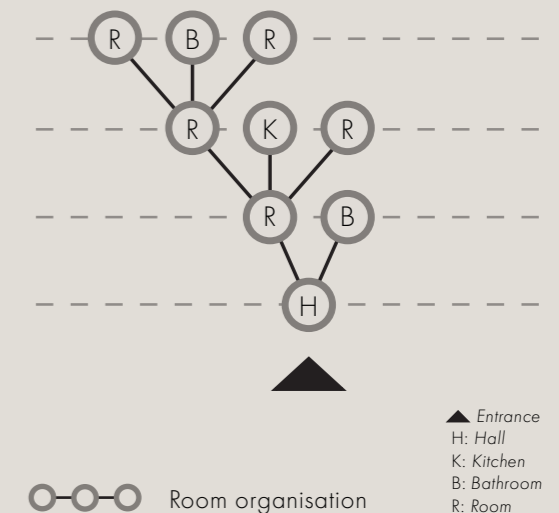

- Entrance
- H: Hall
- K: Kitchen
- B: Bathroom
- R: Room

Room organisation

Figure 61.

Space-syntax diagram of the crossover.

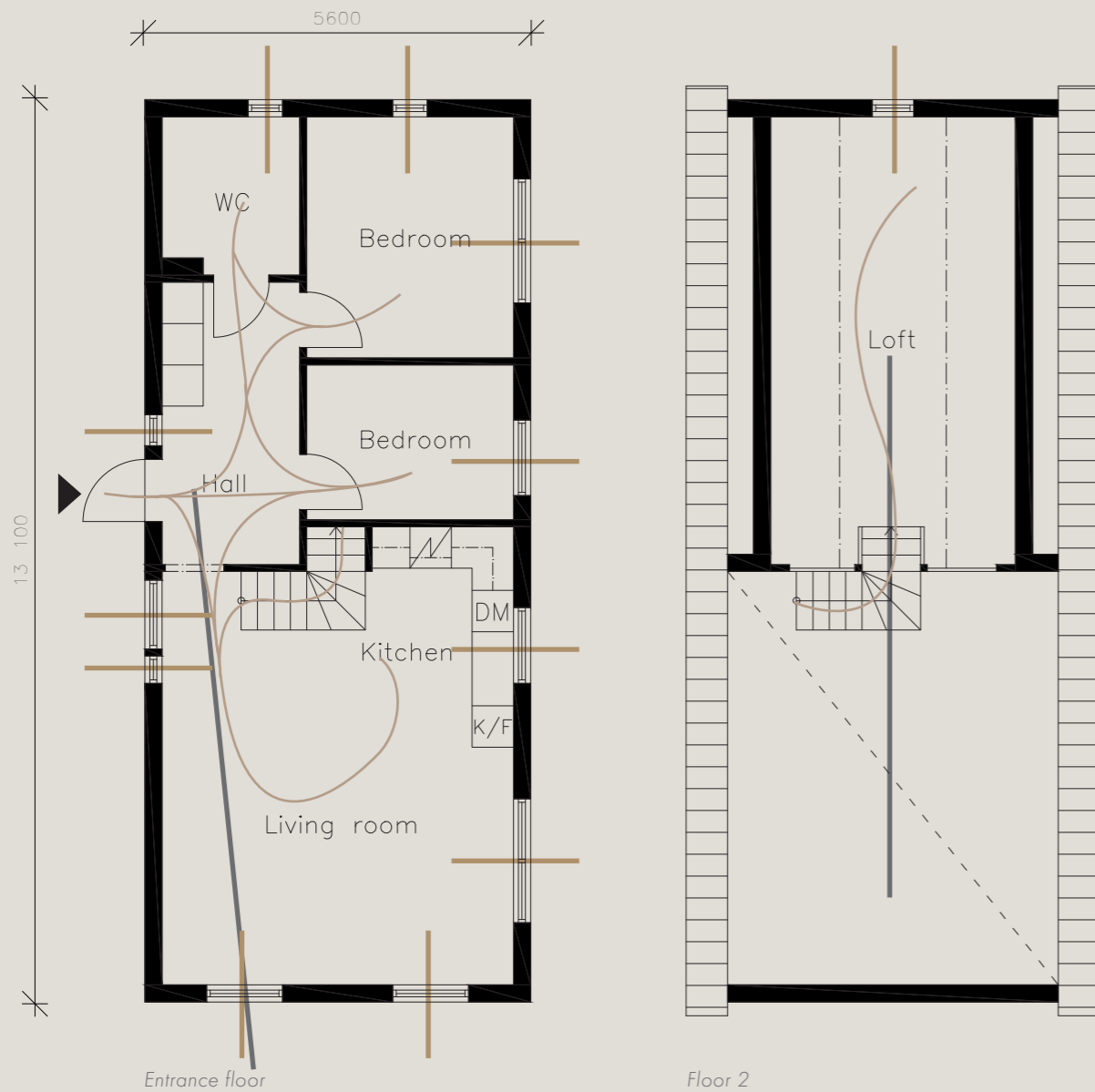

Figure 62.
Floorplan
Scale 1:100 (A4)



CASE STUDY 1 FLOORPLANS

Reference project 2: Ladan 82
Typology: Summerhouse
Area: 81,8 m²
Rooms: 4

General qualities

The second reference project is a catalogue summerhouse, which can be ordered, built, and placed anywhere. It contains three rooms and a loft.

This house has windows in from every direction, giving every single room daylight. The joint kitchen and living room gets daylight from three different directions, as this area takes up half of the floor plan as one big room.

Axiality can be found in two places, both directed to the living room (and beyond, through the window towards outside). One axis starts in the hall, the other one from the loft upstairs.

Movement in this reference is also rather limited, as can be seen in the room organisation chart, access to most rooms go through the hall. Only the stairs to the loft goes through the living room.

One of the biggest qualities in this project could be considered the double ceiling

high in the living room, making this area feel extra spacious and grand.

This house could be rather crowded for a family of four, but as it is only a summerhouse, it is almost expected.

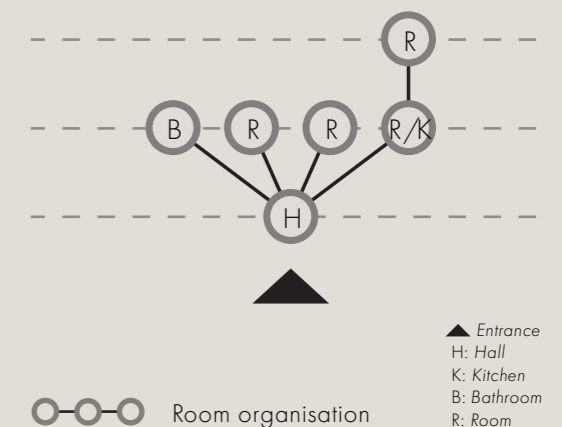
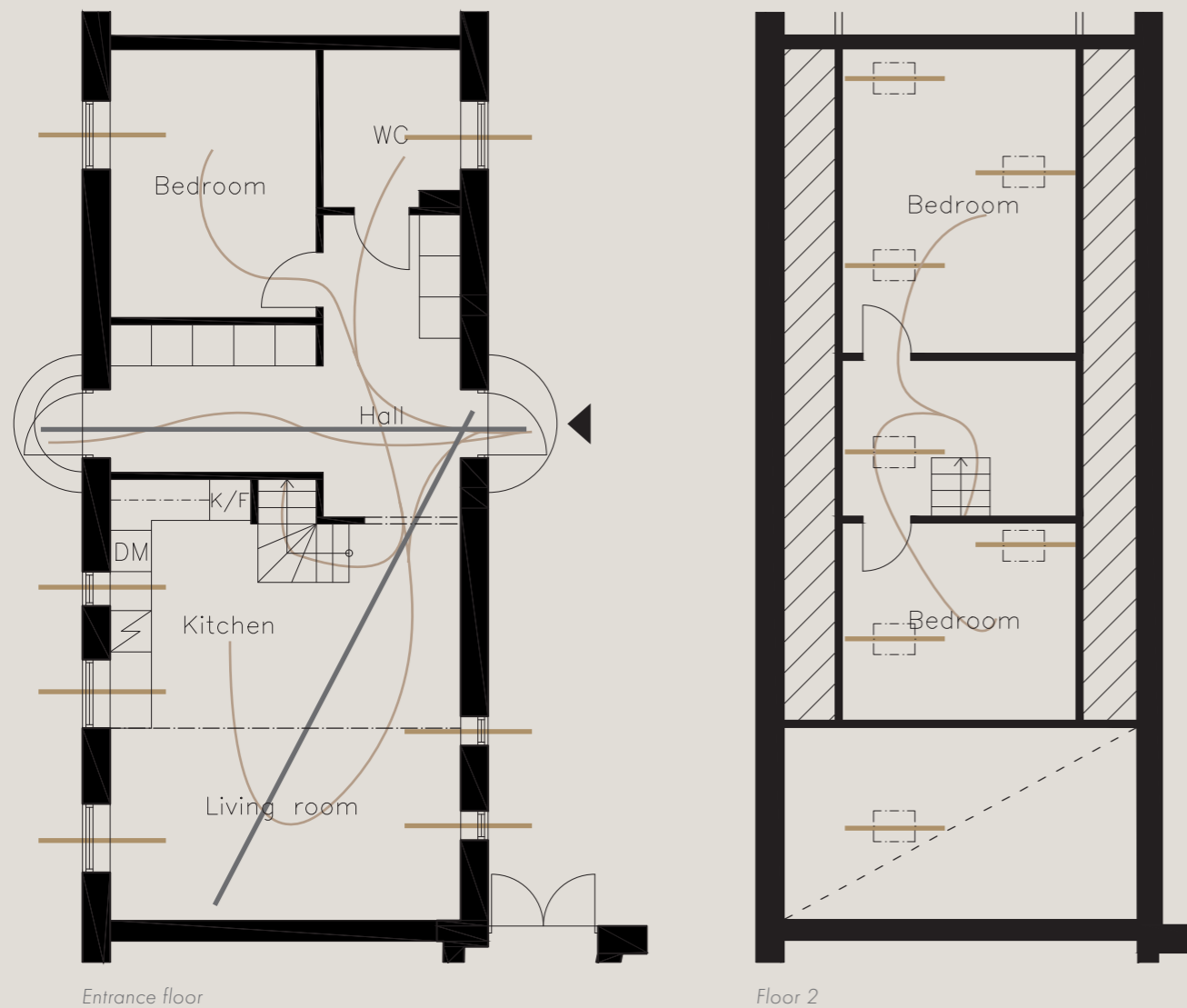

Figure 63.
Space-syntax diagram of the reference project.

CASE STUDY 1 FLOORPLANS



Crossover: Reference project 2

In this crossover, the ambition was to keep the double ceiling height in the living room and the general room organisation order, while also preserving the entrance door, the back door, and all windows from the farmhouse.

The two floorplans from the summerhouse and the farmhouse fit together well, as the measurements of the inner width was the same. This allowed for most of the floorplan of the reference project to remain the same. The biggest change is that one of the bedrooms was moved to the upper floor in order to make room for the hallway passage to the garden. This created two bedrooms on the upper floor, rather than one big loft. That design choice, in turn, took away some of the double ceiling height, making it open only above the living room-side, and not the kitchen-side of the room.

In this version, the axiality becomes less of a quality, as there is no window to the south, and because the upper floor is not a loft, but solid rooms instead.

Also the daylight becomes more limited, since there are only windows in two directions instead of four, due to the placement of the project and the layout of the farmhouse.

However, there is still daylight from three directions in the living room, since there is a skylight above.

What is it gained in this crossover is the movement. The hallway passage in the middle of the dwelling is a great distributor of movement, both from social areas to private areas, and from the inside to the outside.

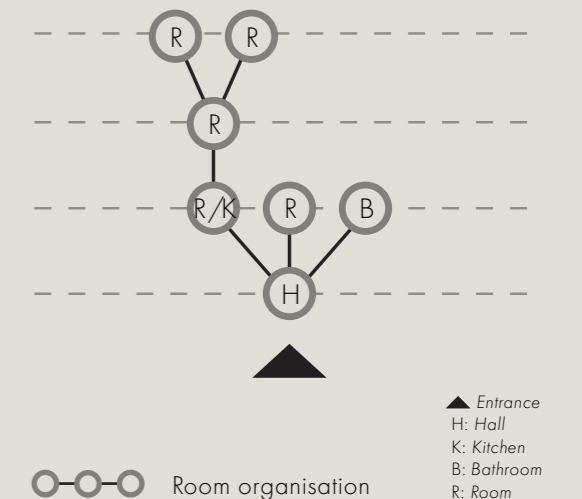

Figure 64.
Floorplan
Scale 1:100 (A4)

Figure 65.
Space-syntax diagram of the crossover.

CASE STUDY 1 FLOORPLANS

Reference project 3: Hus 30
Typology: Attefallshus
Area: 30 m²
Rooms: 1 (+loft)

General qualities

This simple dwelling is first met with a small hall and a small bathroom, and the rest of it is one big room hosting both a kitchen and a living room. The space is limited but enough for 1-2 people staying here.

The big windows in the living room allows the room to be showered in sunlight during the day. Together with the double ceiling height, this contributes to a feeling of spaciousness and openness, possibly making it feel bigger than it is.

As the size of this reference project is rather small, and the number of rooms low, there is not much axuality to be found. The movement as well is limited by this.

Technical instalments have been gathered together as a package, which is a nice quality in any dwelling.

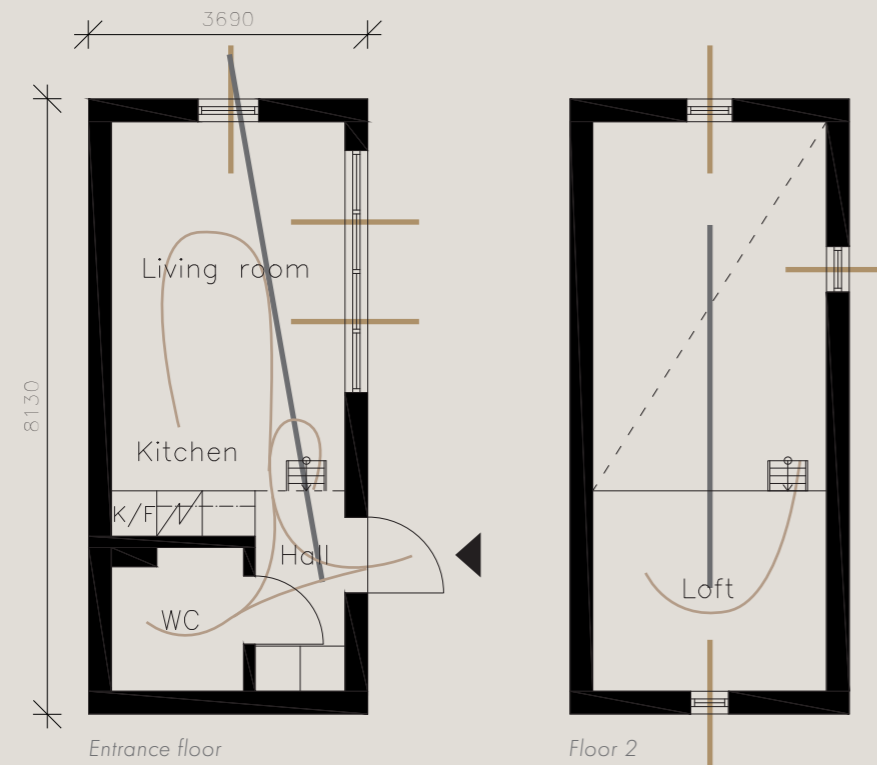

Figure 66.

Floorplan
 Scale 1:100 (A4)



- Axuality
- Movement
- Daylight

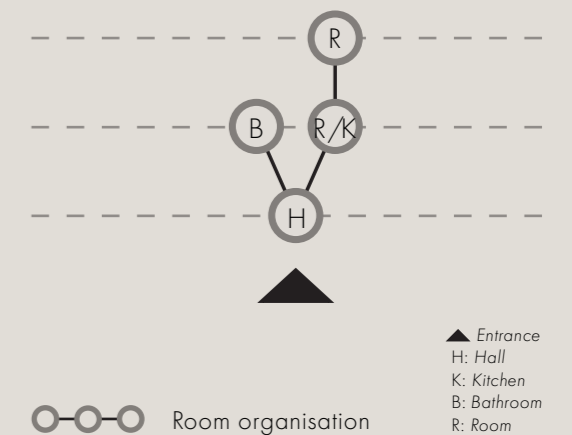
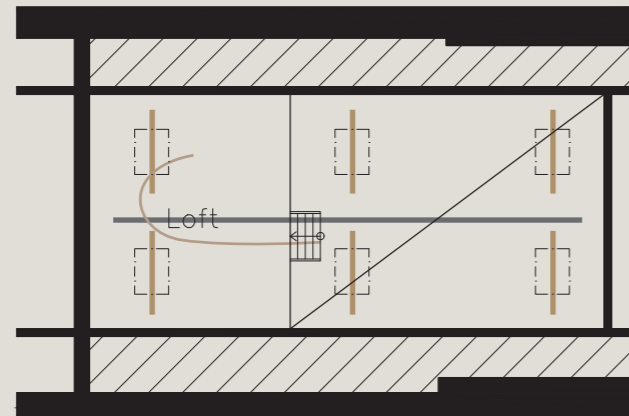
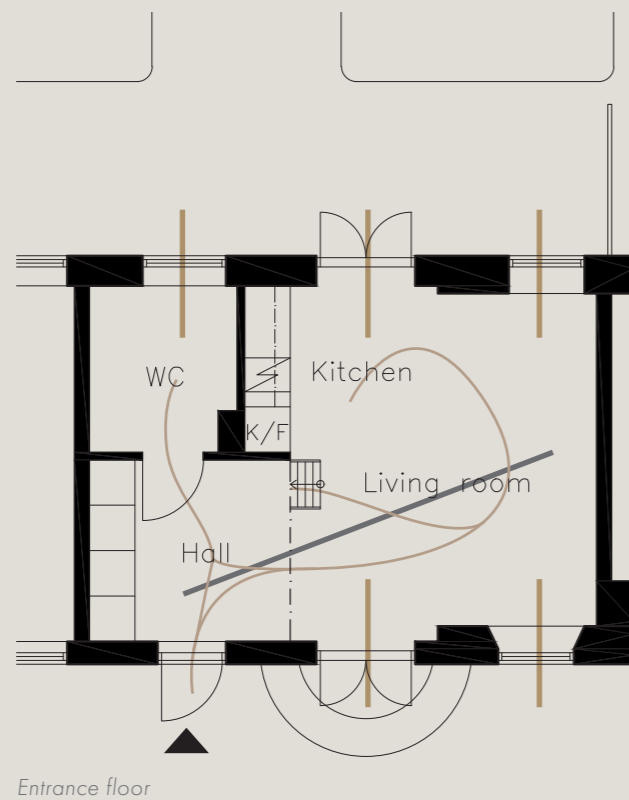

Figure 67.

Space-syntax diagram of the reference project.



Floor 2



Entrance floor

Figure 68.

Floorplan
Scale 1:100 (A4)

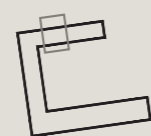

— Axiality
~ Movement
- - - Daylight

CASE STUDY 1 FLOORPLANS

Crossover: Reference project 3

For this crossover, the floorplan has hardly changed at all, except for the width and length of it. The total area, however, remains the same.

The ambition for this crossover was to explore how the floorplan and the movement would be affected if the mirrored double doors in the farmhouse were kept, though not used as a main entrance. In a small dwelling, the movement is generally limited, but with more openings towards the outdoors, more movement across the dwelling is created.

It was no difficulty to preserve the floorplan of the reference project as similar as possible, meaning that its dimensions fit the farmhouse well. The room organisation also works well, probably because of its small size.

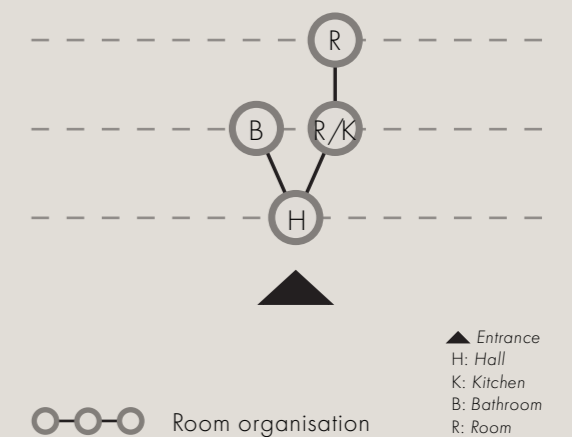

Figure 69.

Space-syntax diagram of the crossover.

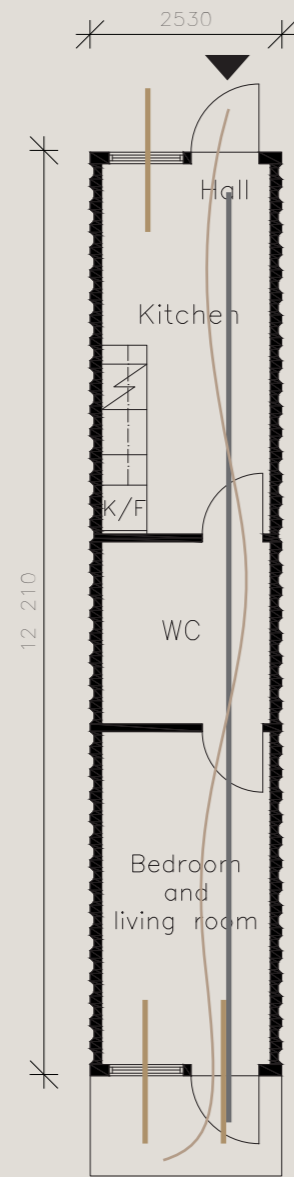

Figure 70.
Floorplan
Scale 1:100 (A4)



- Axiality
- Movement
- Daylight

CASE STUDY 1 FLOORPLANS

Reference project 4: Urban Cribs
Typology: Container home
Area: 26 m²
Rooms: 1

General qualities

This long and narrow home located in Lindholmen, Gothenburg, was made from a 40-foot container. The dimensions of about 12x2,5 meter gives the floorplan a very special layout, where every room has to be passed in order to get to the next. This is a very common room organisation to use in southern farmhouses, as their footprint is usually also long and narrow.

What could be considered unfortunate in this specific reference project, is the fact that the user has to pass through the bathroom to get to the living room. It's not a great quality, especially not if there are more than one person living there, or if the resident is hosting guests.

With dimensions like this, and only having windows in the short ends, an extensive dark core is created in the middle, limiting the amount of daylight quite a lot. This does however explain why the bathroom is placed in the middle, as daylight is not necessary there.

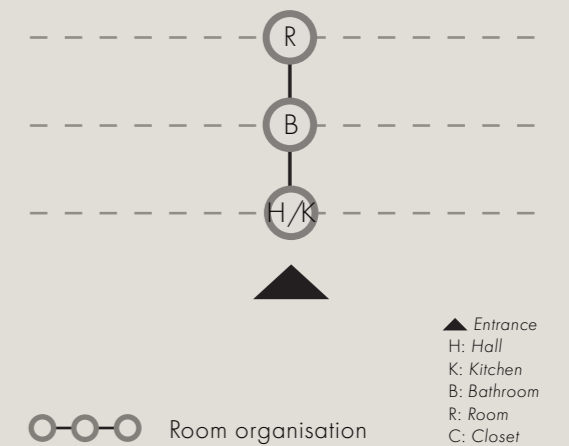

Figure 71.
Space-syntax diagram of the reference project.

CASE STUDY 1 FLOORPLANS

Crossover: Reference project 4

Fitting this floorplan in the farmhouse was no problem at all, it was almost too small as it was so narrow that it was not possible to get daylight from two directions without extensively altering the floorplan and room organisation.

With the windows along the longer end of the apartment, a lot more daylight is allowed in, making the order of the rooms more appealing (mainly not having to use the bathroom as a passage way).

A missed opportunity is the lack of daylight from two directions, but as the floorplan is this narrow, it's not really the light itself that is lacking, but rather the view and feeling of openness that comes with having windows in two directions.

At the same time, it is almost necessary to have the wall closed, as it is more easily furnishable against it, and not spacious enough to have furniture standing freely in the middle of the room. A small dwelling like this will always have its limits, and weighing pros and cons is a necessity.

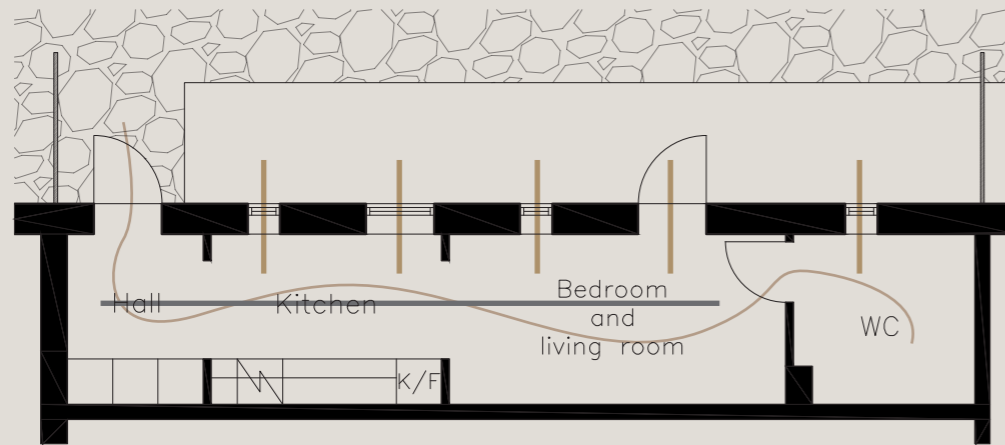
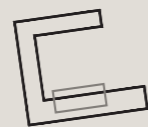
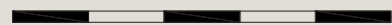

Figure 72.

Floorplan
Scale 1:100 (A4)



— Axiality
~ Movement
- - - Daylight

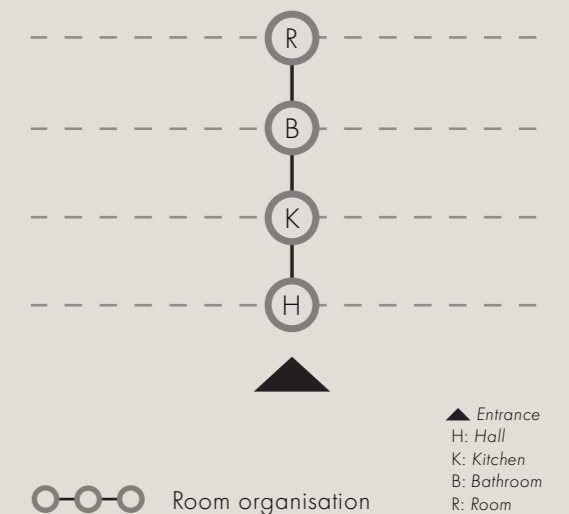

Figure 73.

Space-syntax diagram of the crossover.

CASE STUDY 2 TRANSFORMATION



Figure 74.
Drawing of the renovated farmhouse in Skurup.

Reference project 1: Skånelånga, Skurup

Built: –

Renovated: 2007

Restoration architect: Tradition Bygghantverk

This typical southern farmhouse was renovated by its residents, so there is not much public information about it. Even though a lot of work has been done with it (*changing the roof, new cladding on the facade, new insulation, new added widows, etc.*) it doesn't leave a trace of modern interventions.

The whole project seems to have been done to preserve the historical architecture as is typical for this type of house. Even the new additions to it blends in with the rest, making it very difficult to extinguish what is new and what is old.

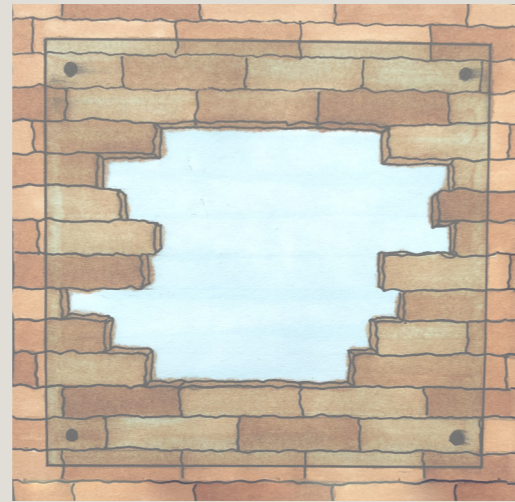

Figure 75.
Drawing of a crumbled opening, covered with a sheet of glass, at Hedmark museum.

Reference project 2: Hedmark museum

Built: 13th century

Renovated: 1967-1979

Restoration architect: Sverre Fehn

Hedmarks museum is located in Hamar, Norway. It is a collection of ruins centered around a medieval cathedral, all of which have been preserved or renovated in some way. Storhamarlåven, the ruin transformed by Sverre Fehn, was originally a barn.

One interesting approach in this renovation is how old and crumbling openings in the facade were displayed by simply framing it with a sheet of glass, rather than installing new modern windows. It is a good example of how something new can be installed without interfering with the old, and instead enhancing it and its history.



Figure 76.
Drawing of the renovated facade, meeting the old facade.

Reference project 3: Koldinghus, Denmark

Built: 13th century

Renovated: 1993

Restoration architect: Inger & Johannes Exner

Koldinghus, located in Kolding, Denmark, is a formerly royal castle with a rich history. It has been renovated several times, the most recent time in the late 1900s. Today it is a museum, room for exhibitions, and a restaurant.

In this project, I found two approaches extra interesting. The first one is how the facade has been restored, with a very distinctive expression. A new layer of modern brick has been added on top of the old layer, but only where the old layer is missing or not functioning enough. So even though the material is the same, there is a big difference in regards of colour and shape, as well as a small projection of the new facade. This

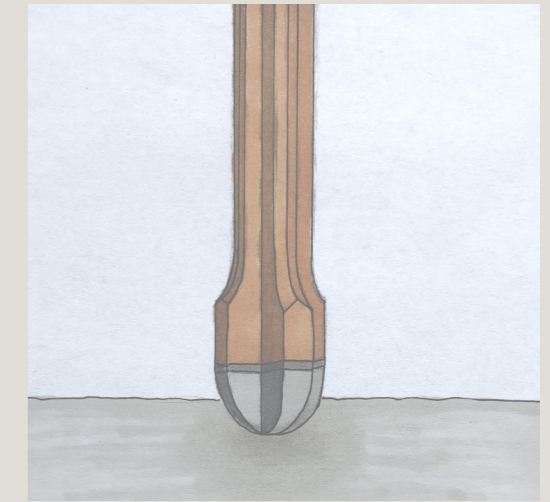

Figure 77.
Drawing of the load bearing pillars, with its rounded bottom leaving a minimal footprint on the ground.

shows just how long life length the old building has, and the need to only add new material where it is required.

As large parts of the roof was missing, there was need for a new one. However, with the old walls damaged and fragile, it was suspected to not be able to bear the weight of the new roof. Load bearing pillars were then installed, but with a rounded foot to leave a minimal footprint, and thereby interfering as little as possible with the old building.

Case studies: **Reflection**

The sketches made in the first case study were just that – *sketches*. They are explorations that were made rather quickly as a way to investigate and identify different qualities, good and bad. The sketches are not without flaws, and since the exploration was the main objective, it was never my intent to make the perfect floorplan in the case study.

One rather big flaw I noticed when starting the actual design project, was that the ceiling height I was working with during the case studies was not as high as I thought, making the upper floor quite inaccessible.

However, one of my favourite qualities found in the case studies were the solutions with lofts. I considered them to be quite spacious, bright, and open, even if the area was small. There was a lot of axiality and daylight access to be found in them.

The lack of ceiling height on the upper floor in the farmhouse, together with the idea of lofts, led me to start designing the project without an upper floor, giving the dwellings double ceiling height in some rooms, and lofts above the others. Of course, all floorplans will be made accessible, but for residents that are not in need of it, the lofts can act as flexible rooms, allowing the dwelling to be used or furnished in many different ways.

Regarding the different possibilities for room organisation, one of the lesser qualitative reference projects was the container home, with very limited daylight and a passage-way through the bathroom. However, it was also the sketch that, in my opinion, got the most drastic change in a good way, given the new limits and conditions of

the farmhouse. And since "links" is a very common room organisation strategy in the southern farmhouses, this is something I will keep in the design project, as it can create a beautiful axiality and experience of the dwelling if it is well executed.

A design element I feel is missing in the reference projects is circular movement. Even though all references are different, they're all rather small, which is why I think this quality is missing, since the space is limited. Nonetheless, circular movement is something I bring with me into the design project, even though it is missing from the reference projects.

The second case study was a lot more simple and mostly meant to act as a source of inspiration. Since it is a small study, it gives a limited result. It was rather difficult to find reference projects that were similar to the farmhouse. Even though renovations of farmhouses are most likely quite common, they are not as publicly advertised, and therefore not as easy to find. As a consequence of this, I chose two bigger public buildings as reference projects as well. They might have qualities and designs that are not necessary or even related to housing, but I still found inspiration in them that I will be able to use in the design project.

I think the second and third reference projects in case study 2 dealt with the meeting between old and new in a very pleasing way. They were both very respectful to the old materials, trying to interfere with it as little as possible, even highlighting it by using modern material and techniques around it. That approach contains an interesting discussion, as I believe many people would not like it to be modernised

at all, but rather let the renovation blend in with the old parts, as if it had never withered in the first place. I guess it depends on what you like personally, but I think it is a nice way of showing a timeline of a building's life. It calls attention to its history and foundation, and leaves traces of events that happened along the way. It allows a building to age and evolve with time, and just like the design project of this thesis, it can be given a new purpose.

What I will bring with me from this case study is how something old can be preserved and highlighted *through* the help of something new. I will not use a specific approach from these reference projects, but they have given me inspiration on how to proceed with the architecture, which will be shown in the design project.

Sub questions

Question A:

How can different design elements be used to accommodate qualitative living standards and multiple dwellings within the dimensions of a Skånelänga farmhouse?

Of the different design elements that have been presented in this thesis, only a few of them were used in the case study. The design elements can be used as a tool, as well as an approach, when developing a project. By establishing which design element will be used, and which qualities you wish to achieve, the project in question will get different outcomes.

In short, by identifying the desired outcome of a project, design elements can be used to accommodate these desires. Every project

is different, and therefore every strategy will be as well. By setting a framework for each project, and then choosing a design element that will achieve this, is how the elements can be used.

In this project, I wish to preserve the typical way of placing rooms next to each other, so working with axiality and room organisation is of great use. Movement is important as well, since the room organisation can create a rather limited way of moving. I also aim to preserve facade openings (such as windows and doors), so here I work a lot with daylight and, again, axiality.

These are all elements that I have personally chosen for my project. For another project, the desired outcome and design elements might be different.

Question B:

What principles of architectural heritage preservation and restoration can guide the transformation process when repurposing the farmhouse, to ensure its unique characteristics and historical significance?

In my brief case study of transformation, I found two main principles of preservation and restoration. Either you can restore it to how it once was, with little to no trace of an intervention, or you can highlight something old by respectfully framing it with something new, creating a contrast between them. Both of them are ways to ensure the farmhouse's unique characteristics and historical significance, which is why both principles are used in different parts of the design project.

PART FOUR

PART FOUR: DESIGN PROJECT

Framework

Findings and explorations done in the first three parts gives the foundation for the design project in this fourth and final part.

From the theory presented in Part 1, the most important findings that I bring into the design is how social sustainability can be obtained by meeting *the eight needs* listed by Gehl. They mostly act as guidelines in the project, since they are quite extensive and connected to many other aspects presented, heritage for example.

The heritage is very important for the site, historically and architecturally. And going back to social sustainability it partially answers to three of the eight needs – *purposefulness, identity, and aesthetics and beauty*.

Moving forward, the materials and the construction in the inventory, in Part 2, are also connected to the heritage. As part of the heritage, the materials and the structure is to be preserved in the project, and when an addition is made, it is to respect it, ensuring its unique characteristics and historical significance.

As a way to make minimal change to the existing building, openings in the facade will be preserved as much as possible. In some cases this will not be fully possible, since the south wing is not at all adapted for housing today.

Qualities and design elements are present in all three parts. The most prominent design elements are axiality, movement and

daylight, and one of the strongest qualities in the case studies are, in my opinion, the lofts. However, circular movement is lacking, which I find unfortunate.

This leads me to put up the following framework for the design:

- Double ceiling height throughout the farmhouse, with lofts on top of bedrooms or other smaller rooms.
- New additions to the building will be constructed of the same materials and techniques as the existing building.
- Reused material will be used when possible.
- Daylight from two directions in every dwelling.
- Circular movement in all dwellings.
- Axiality in all dwellings.
- One car per household.
- Keep openings in the facade where it is possible for a good floorplan.



Gardens

The private gardens are divided with a fence and the possibility for residents to further add privacy with greenery. Hard surfaces around the farmhouse are added to align with the existing, typical layout.

The gazebo is moved to the shared garden, and a playground for kids is added. Almost all trees have been preserved for a natural space for activity, as well as for a decision to make minimal intervention on existing nature.

Figure 78.

Siteplan
Scale 1:500 (A4)

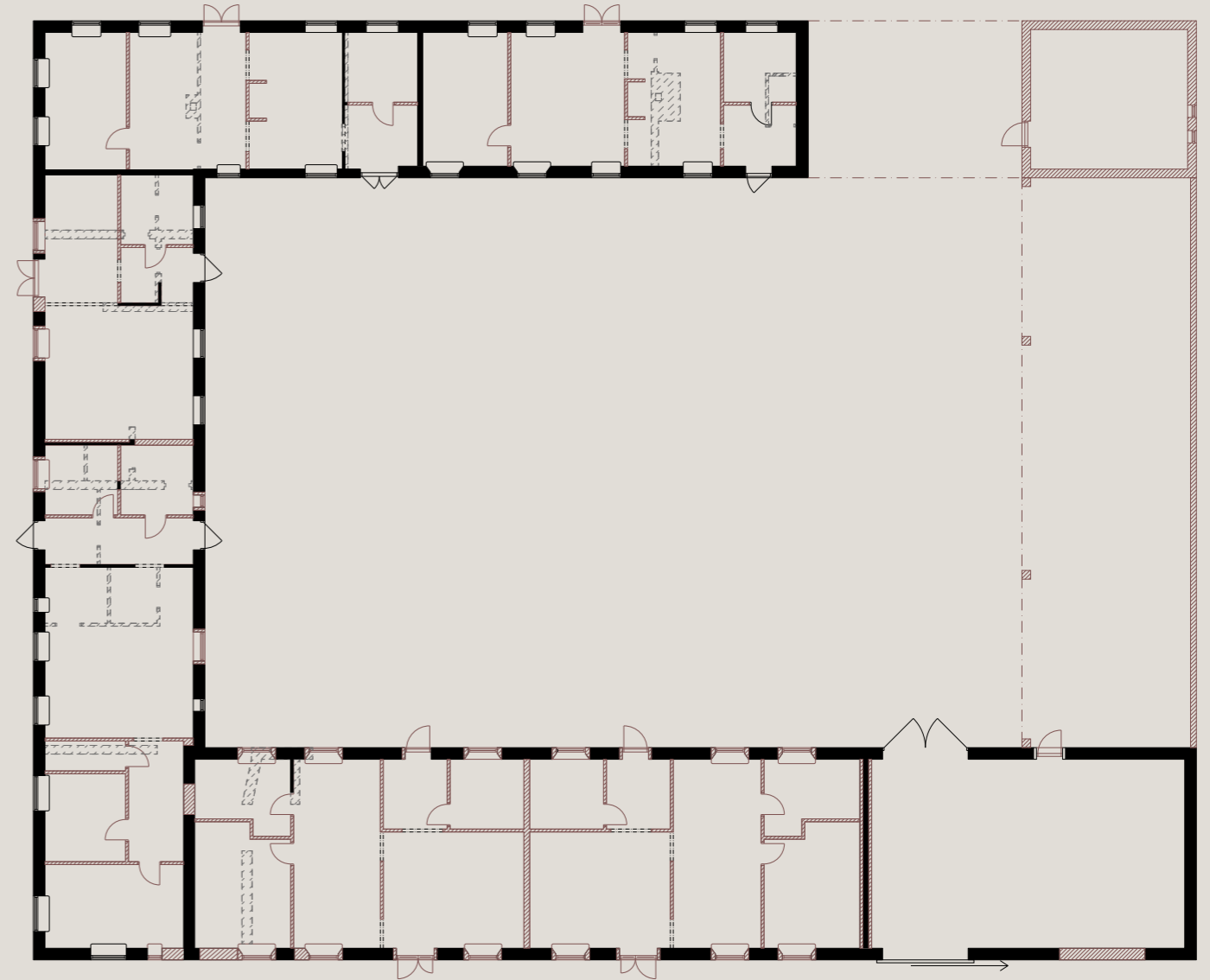

Transformation

This floorplan shows which walls are preserved, which are new, and which are removed. It is meant to give an overview of the transformation.







-  Existing wall
-  New wall
-  Demolished wall
-  New door
-  Existing door
-  New window
-  Existing window

Figure 79.

Floorplan
Scale 1:250 (A4)



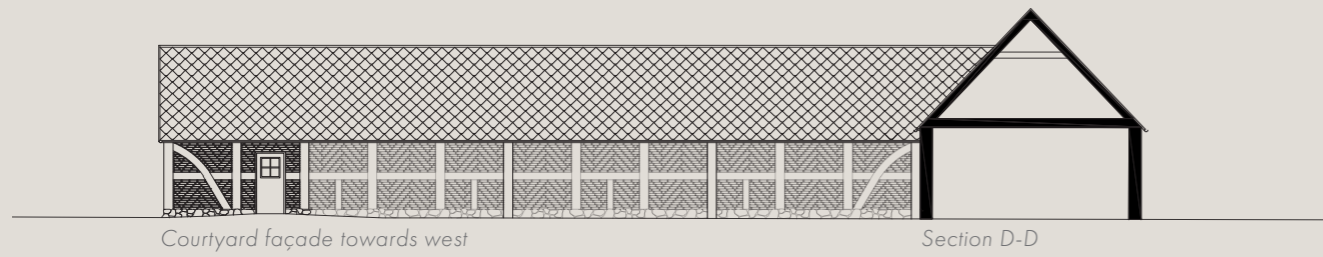
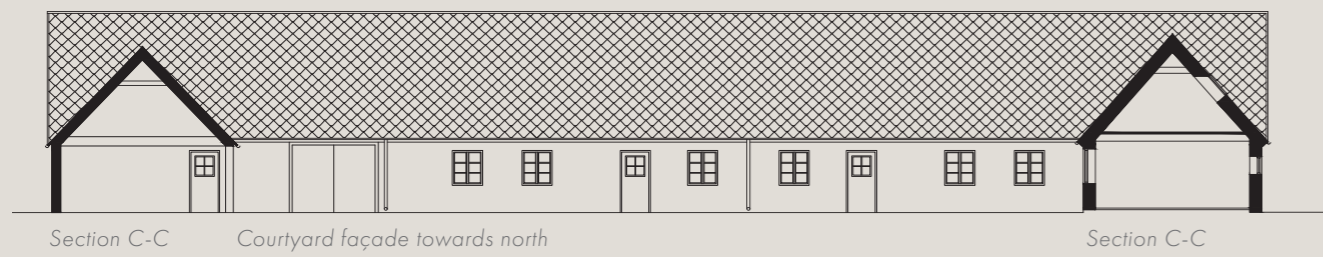

Figure 80-83.
 Facades and sections
 Scale 1:250

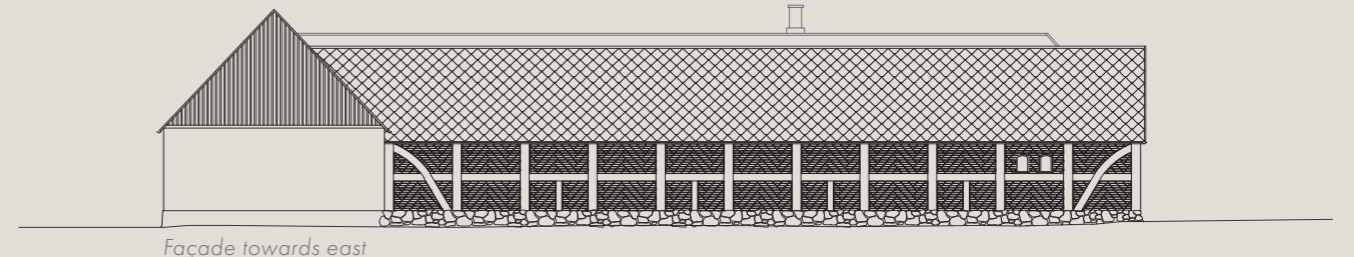
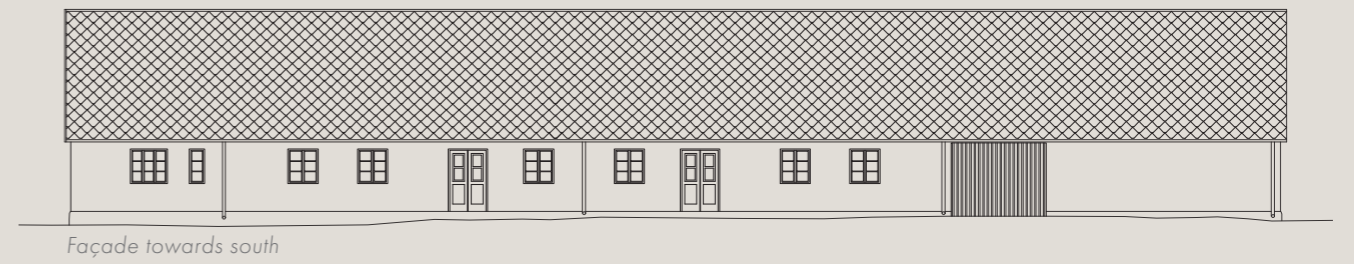
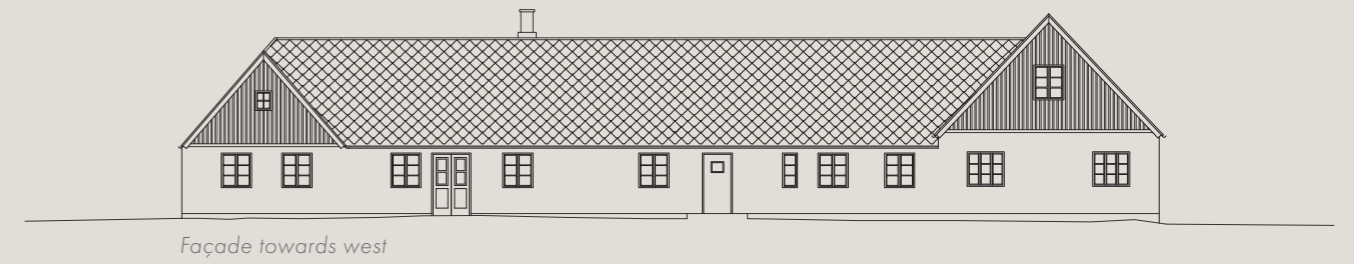

Figure 84-87.
 Facades and sections
 Scale 1:250

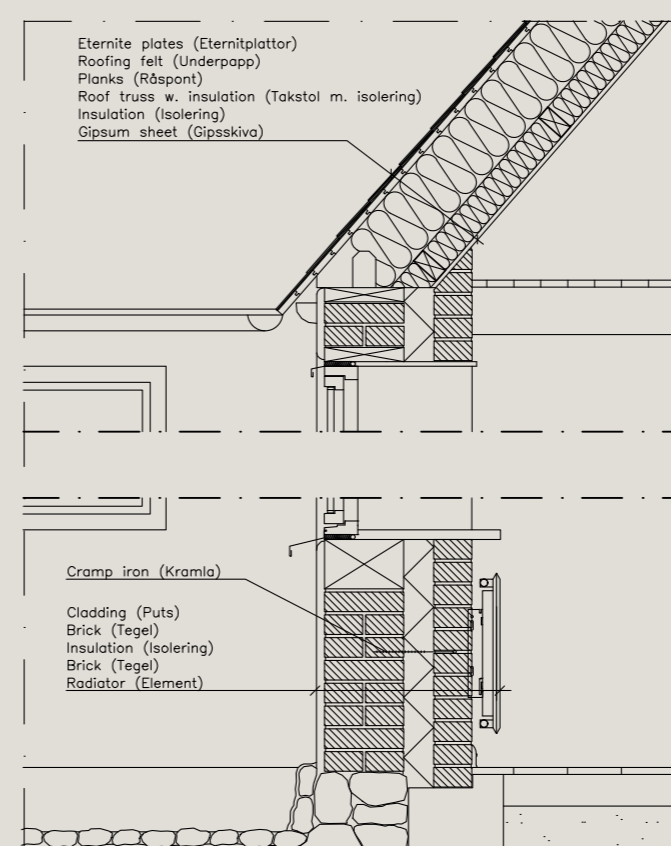
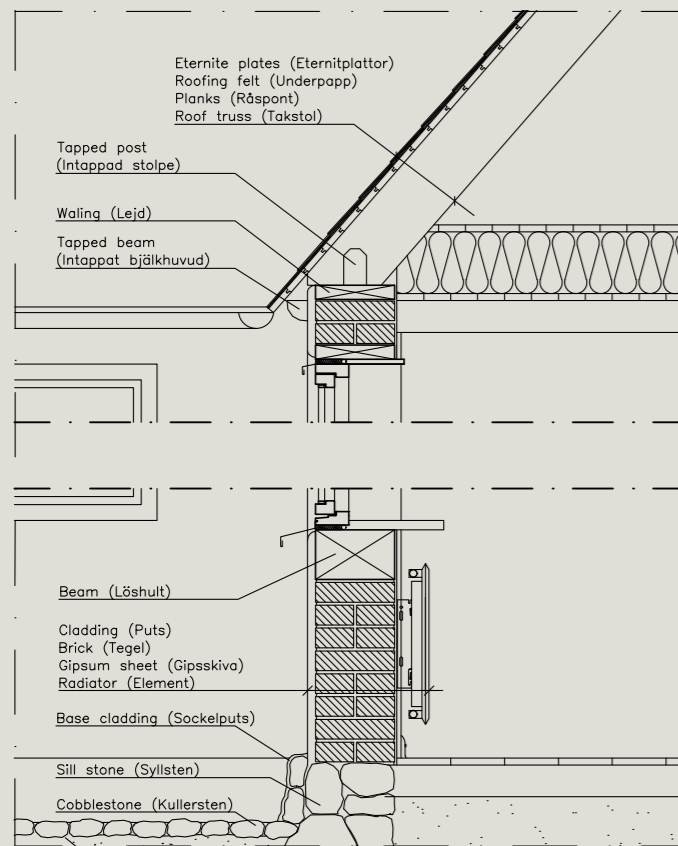
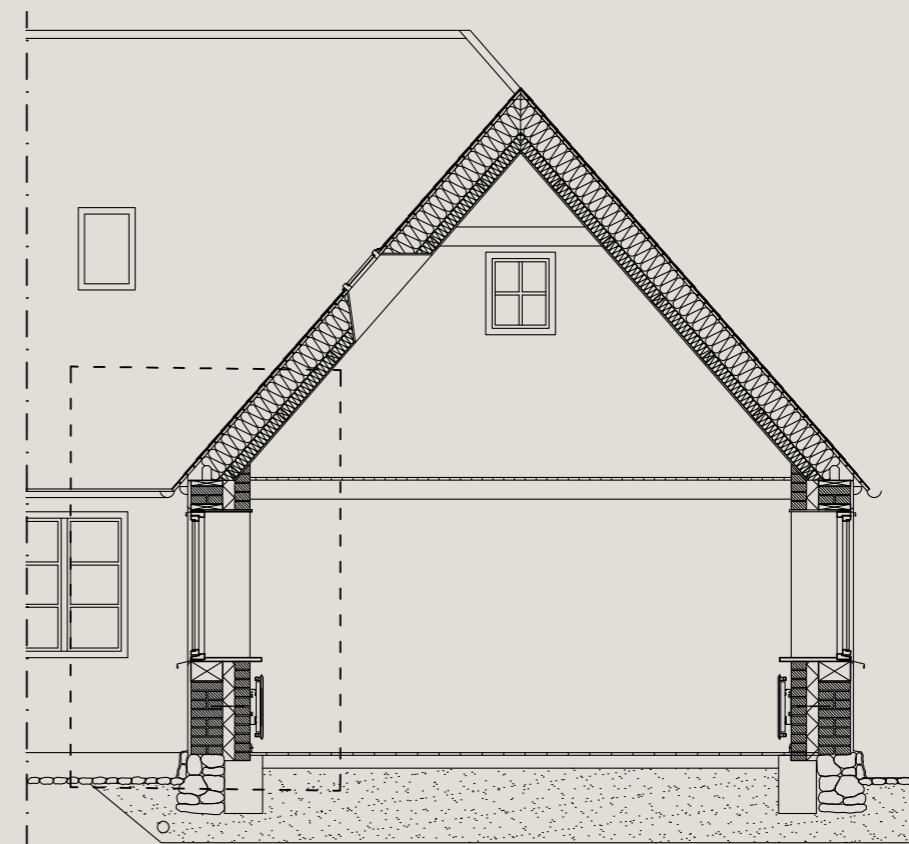
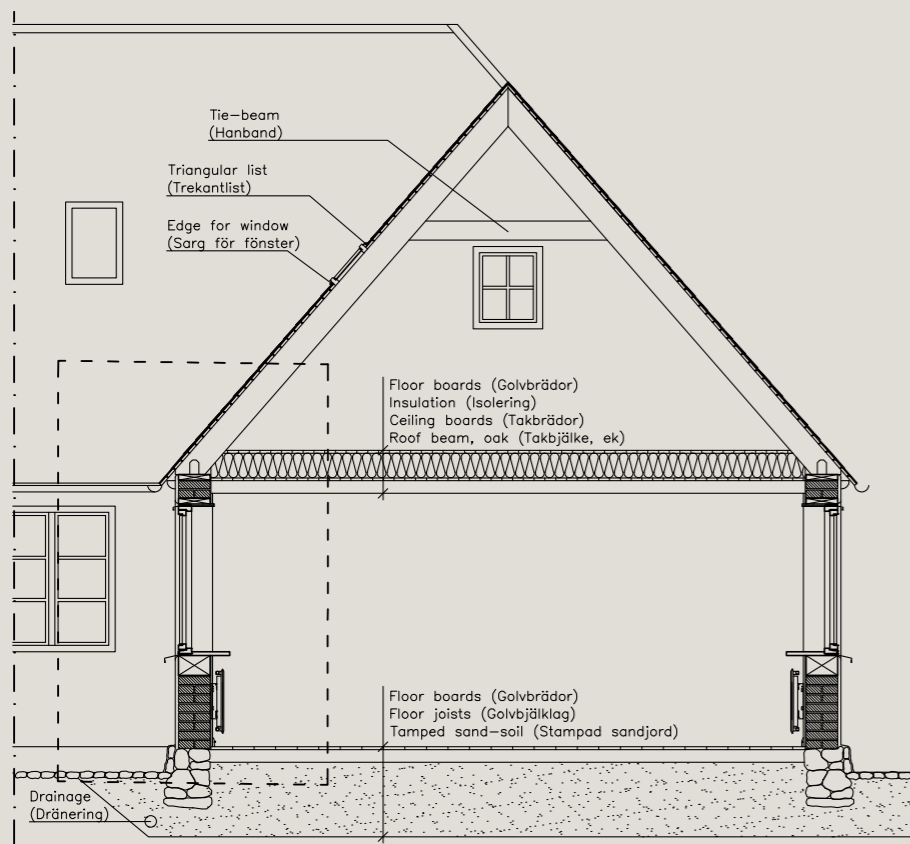

Figure 88.
Detail section (old facade)
Scale 1:50, 1:20

Figure 89.
Detail section (new facade)
Scale 1:50, 1:20

Displaying the old through the new

As a combined result of the inventory and the second case study, a desire to expose all building materials arose.

The existing facade is renovated and restored to preserve the look it has today. The new wing is built with the same technique as the rest of the farmhouse, but leaves the building materials exposed for its viewers to admire the details behind the work.

The difference between the two express a milestone in the history of the farmhouse, declaring that something new has happened. By using the same construction, the new addition respects the heritage of the farmhouse, and by stripping it of the cladding it also highlights the heritage as well as the construction.

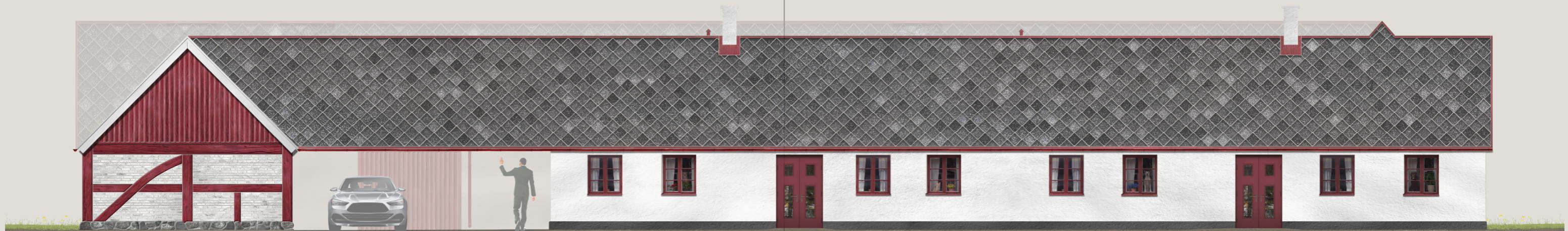
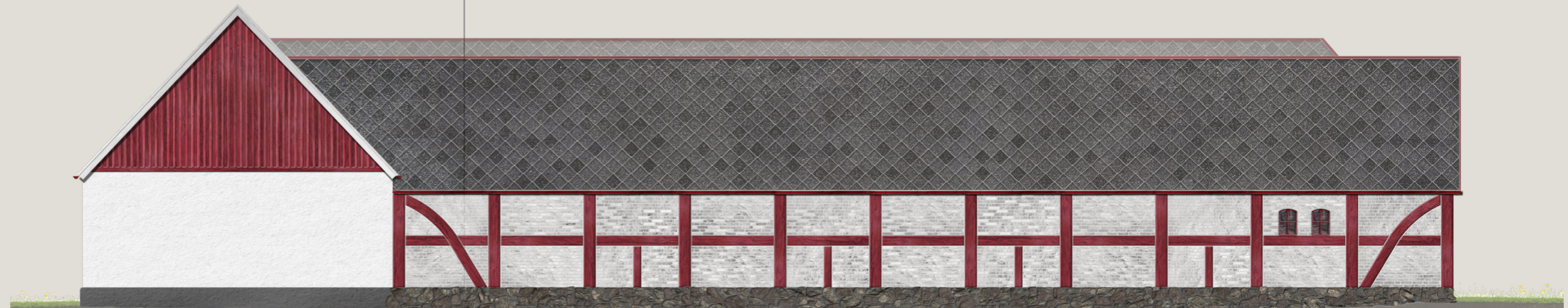
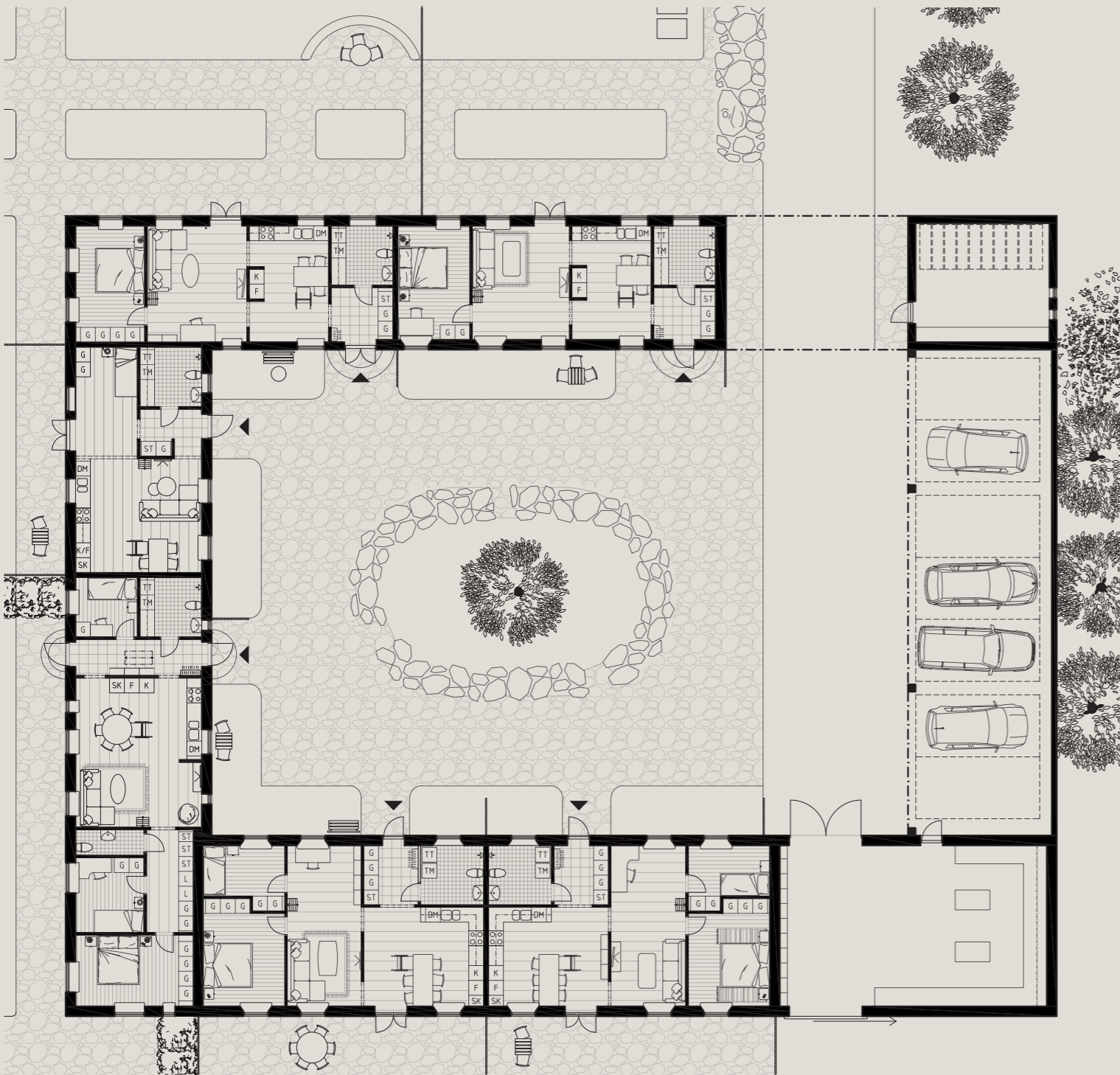

Figure 90-91.
Facade illustrations.



Dwelling quantity & sizes

- 1 Studio apartment + loft: 45 m²
- 2 1-bedroom apartment + loft: 59 m²
- 2 2-bedroom apartment + loft: 74 m²
- 1 3-bedroom apartment + loft: 85 m²

Figure 92.

Floorplan, entrance floor
Scale 1:250 (A4)

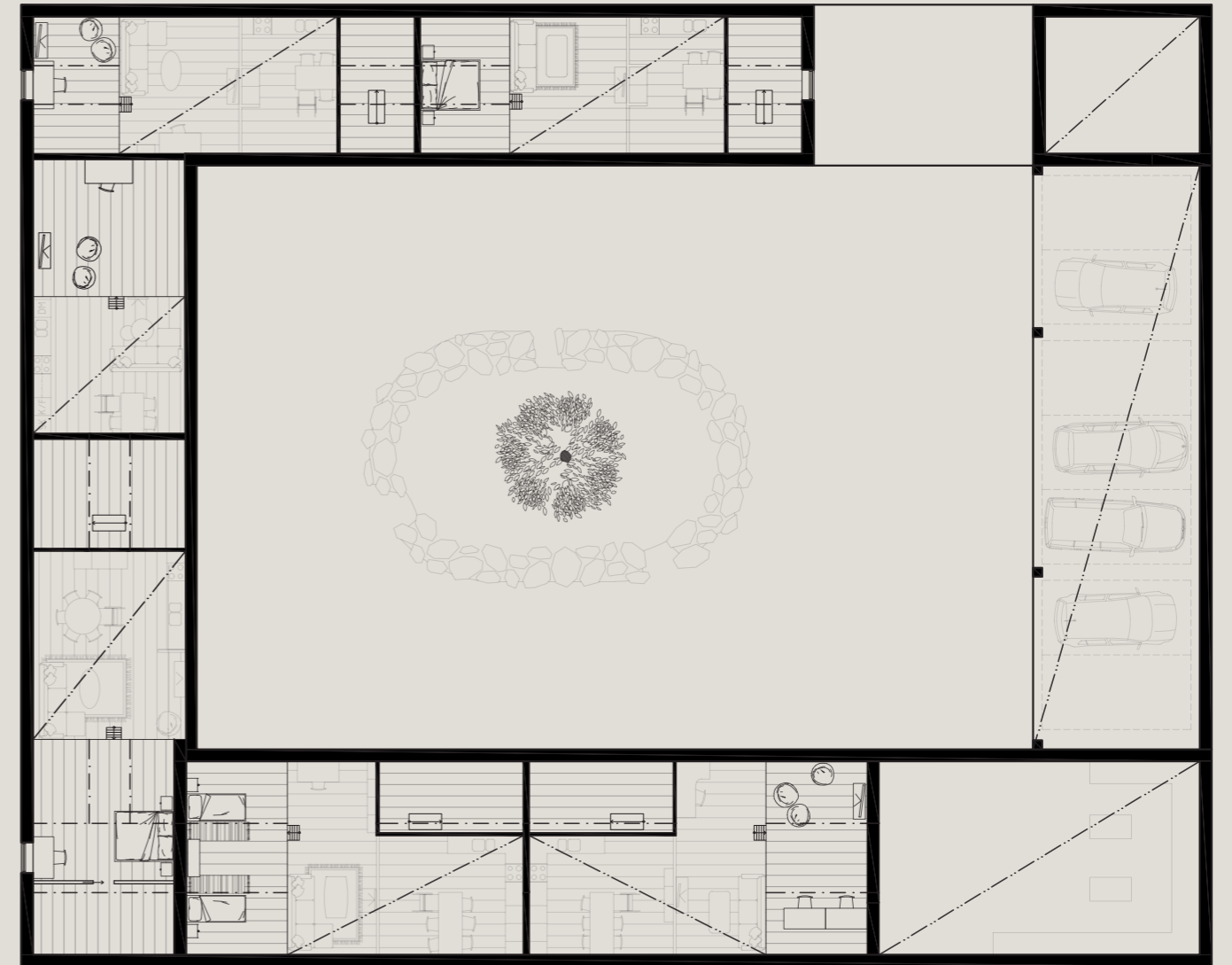

Figure 93.

Floorplan, floor 2
Scale 1:250 (A4)



94.
Perspective illustration.



Figure 95.
Perspective illustration.



94.
Perspective illustration, kitchen, 2 bedroom apt.
These illustrations are collages of personal photos and the AI function in Photoshop.



Figure 95.
Perspective illustration, living room, 3 bedroom apt.
These illustrations are collages of personal photos and the AI function in Photoshop.



96.
Perspective illustration, window, studio apt.
These illustrations are collages of personal photos and the AI function in Photoshop.

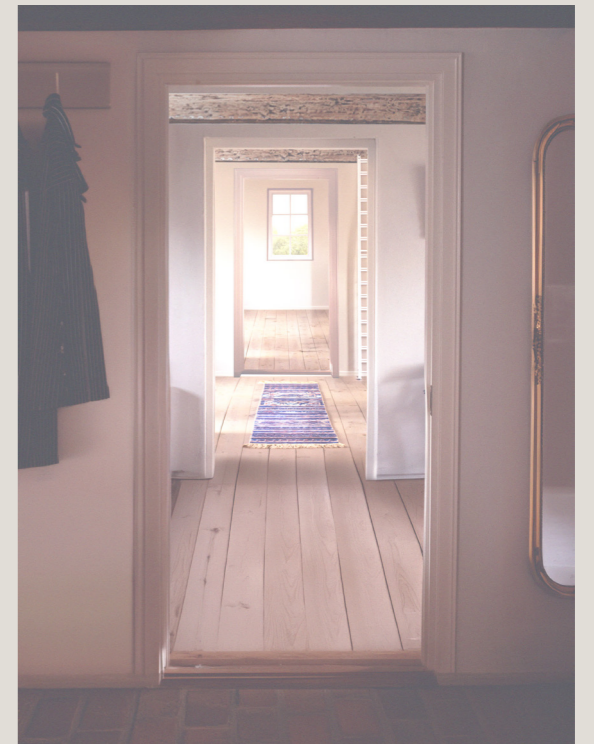
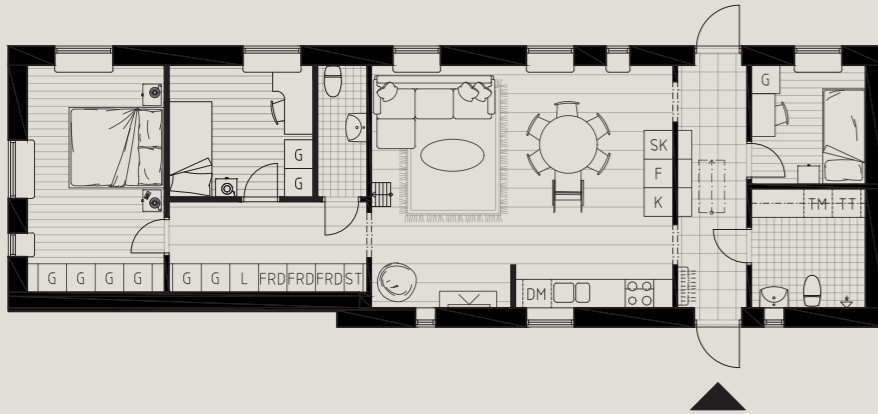
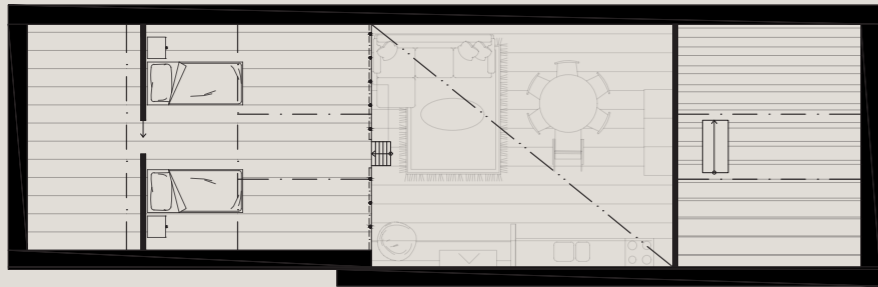
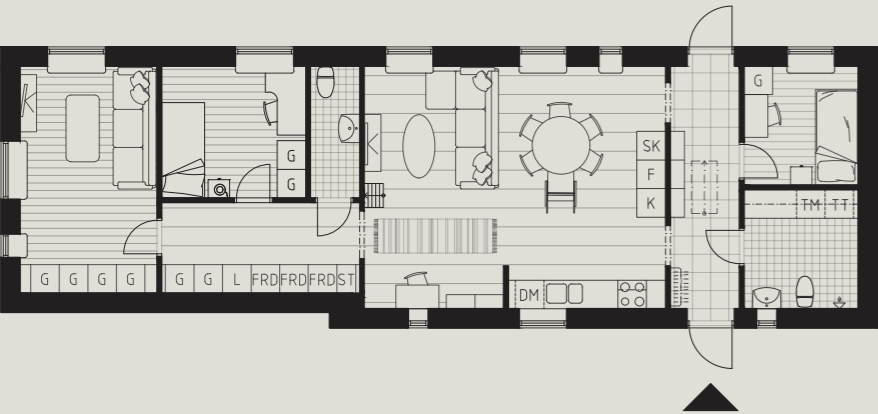
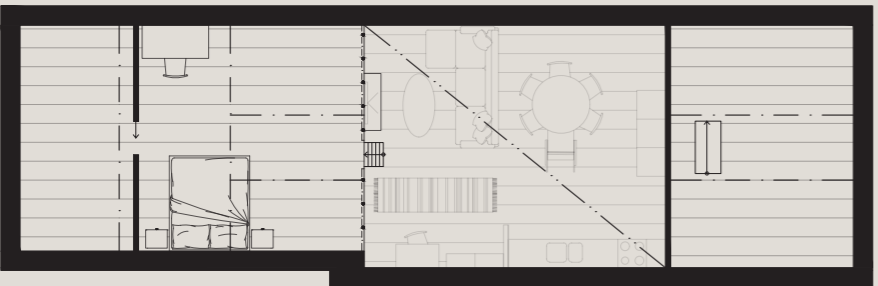

Figure 97.
Perspective illustration, axially, 1 bedroom apt.
These illustrations are collages of personal photos and the AI function in Photoshop.



3-bedroom apt. + loft
Furnishing 1



3-bedroom apt. + loft
Furnishing 2

Figure 98-99
Furnishability in the dwellings.

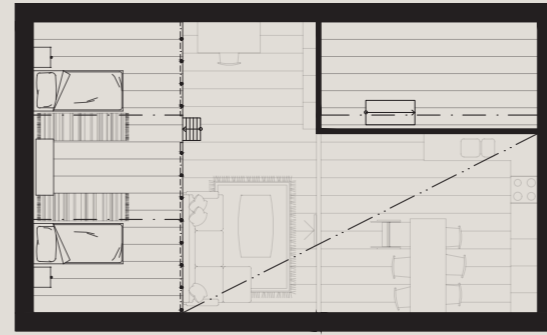

2-bedroom apt. + loft
Furnishing 1

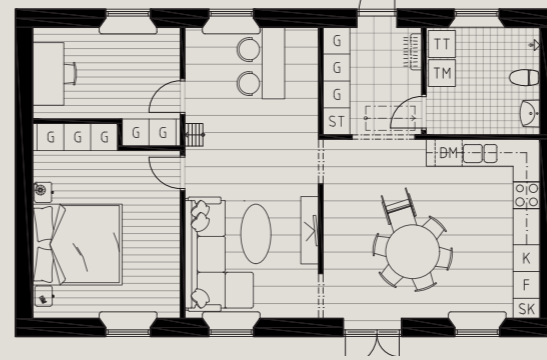
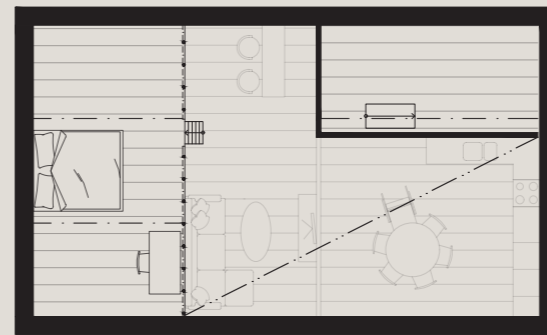

2-bedroom apt. + loft
Furnishing 2

Figure 100-101.
Furnishability in the dwellings.

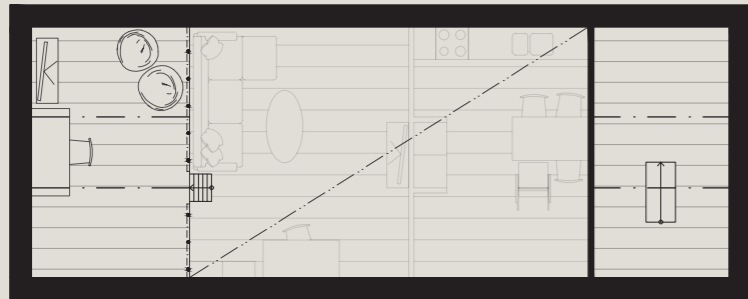

1-bedroom apt. + loft
Furnishing 1

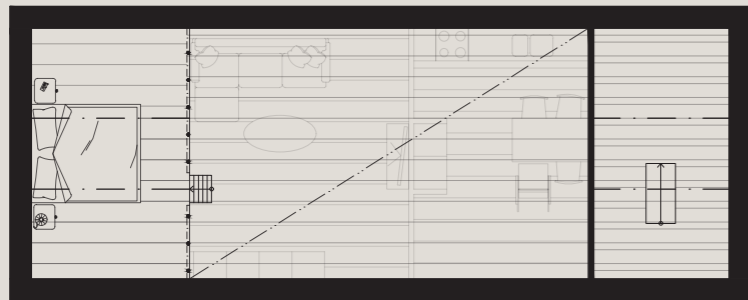

1-bedroom apt. + loft
Furnishing 2

Figure 102-103.
Furnishability in the dwellings.

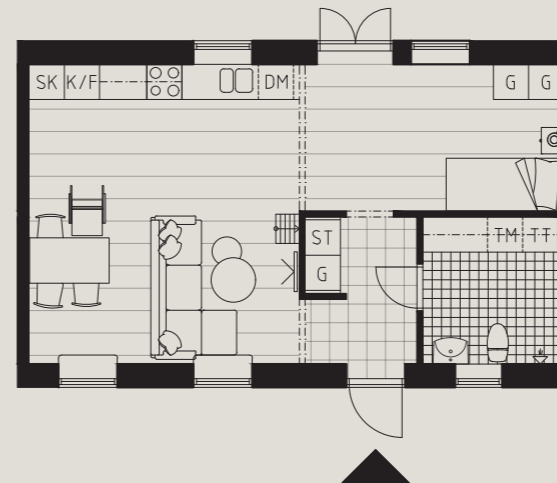
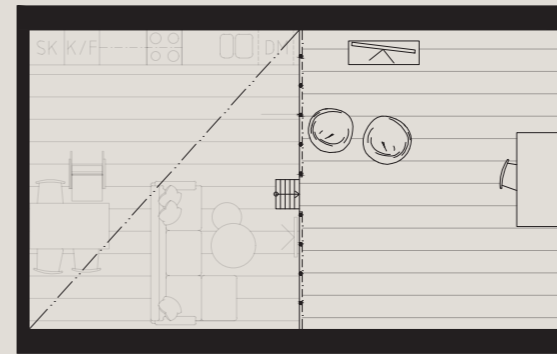

Studio apartment + loft
Furnishing 1

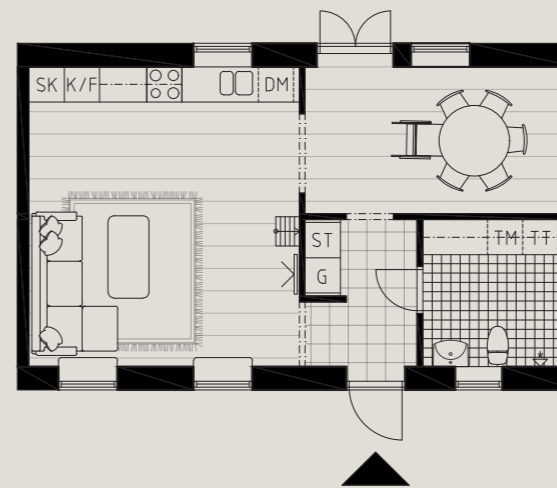
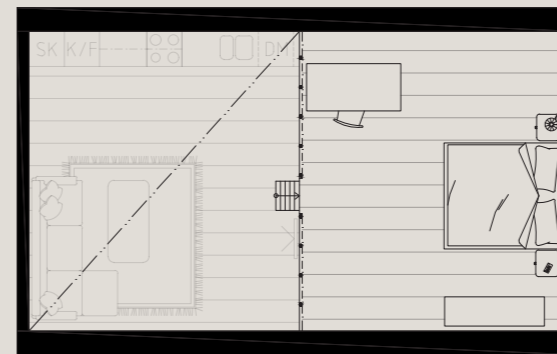

Studio apartment + loft
Furnishing 2

Figure 104-105.
Furnishability in the dwellings.

Discussion and conclusion

Sustainability is a big part of this project, especially social sustainability. *The eight needs* by Ingrid Gehl have been a great source and guide throughout the project. They were not part of the framework for the design because of how extensive they are, but nonetheless they have been present, which is why it will be discussed here how the needs have been met in the design.

The need for human contact can be met in the courtyard, the garage, the workshop and the shared garden to the east. Every dwelling has their own little front garden in the courtyard, even though it is a privately owned part of the dwelling, it is an open space allowing the residents to socialise with the neighbours. Since this is also the placement for the main entrances and the garage, it allows for spontaneous meeting when coming home or leaving the residence. Shared spaces like the workshop or the garden behind the garage allows for both planned and spontaneous meetings.

The need for privacy can instead be met in the private gardens along the outer side of the farmhouse. These are more closed off towards the neighbours, allowing the residents to keep more to themselves if they wish. The same goes for inside the dwellings, where social and private spaces are divided, and the private rooms are designed with a lower, more intimate, ceiling height (the lofts are placed on top of the private rooms), creating a more private atmosphere than the opens and spacious social rooms.

But privacy is not only limited to closed off rooms or gardens. As mentioned in

the theory, privacy is also about external influences, like noise. Limiting the number of dwellings, and having a mixed target group, decreases overcrowding and noise, which in turn promotes privacy.

The need for varied experiences was more challenging to meet. This need felt more in tune with city living, since the examples brought up were varied means of transportation, mixed-use buildings, and seasonal or temporal structures. Varied means of transportation is difficult to meet due to the location in the countryside, the options here are mostly car or bike (or walking). And the other examples, even though they would be great for the residents, I don't think the businesses in question would survive for long without other external visitors.

The need for purposefulness can be found in the farmhouse and its new community as a whole. Gardening and maintenance were two of the examples brought up by Gehl, which are very present in the farmhouse and its heritage. Here, a question of responsibility arises – maybe not everyone *wants* to take care of these things, so who is responsible for it? Just like in apartment buildings or rowhouses, there must be a housing cooperative dealing with questions like this, which then can allow the residents to choose how active they wish to be in these questions and decisions. The workshop is another example of what could bring purpose to the residents, allowing them to pursue a hobby, fix things, or start a club, to mention some examples.

The need for play is met both with big private

gardens as well as the shared garden, where kids can play, the parents can meet and socialise, or the child-free families can use the space for other activities. The north part of the shared garden is left as it is today, filled with trees and bushes, both to give the residents a sense of nature, but also to allow play of imagination, since play should not be restricted only to built structures like playgrounds. The need for play shouldn't either be restricted to the outdoors, which is why I believe the concept of lofts is a good solution to provide flexibility in the dwellings, since these can be used as a playroom, gaming room, or a regular bedroom in order to open up space on the entrance floor for other activities.

The need for structure and orientation is another challenge in this project. As mentioned in the theory, it is more common in large public buildings, with more residents or visitors, but one way to meet this need in the design project has been to have a clear division between private and shared areas. This is partially why the workshop, garage, and the shared garden are all located to the east of the courtyard, all dwellings with belonging gardens are around the other sides of the courtyard, and the courtyard itself acts as a central core meeting them all.

The need for ownership and identity has been difficult to show in the design itself, but it has all along been the intention that these dwellings are condominiums, meaning that the resident purchase their home, it is not for rent. This gives the home owner the possibility of having an influence and making their home more personal. Of course, as preserving the heritage is a big

part of this project, there needs to be some restrictions as to what is allowed to change, but this would be managed through the housing cooperative mentioned earlier.

The need for aesthetics and beauty is in my opinion strongly connected to the heritage of the site. The construction, attention to detail, and preservation of historical objects and craftsmanship all include aesthetical aspects and beauty. Patterns and variety are also to be found, a variety in the expressions of the facades (new versus old), and patterns in the recurring timber construction, the visual roof beams in the dwellings, window placement, and ground material.

Some of these needs have a bigger presence in the project than others. I think they could be developed and displayed even more, if the work on this were to continue, especially on the outside of the farmhouse. A lot of the garden is now left untouched, since the focus has been on the housing, but as the gardens are important for the dwellings, I think they could be developed and improved even further.

As one of the guidelines for the project was to preserve the openings in the facade as much as possible, it could be questioned why the south wing was turned into residential space, rather than the new addition to the farmhouse. The south wing is not at all adapted for housing today, with its few and small windows and uninsulated walls it could have been well suited for a garage instead. The reason behind this decision is to limit the traffic in the courtyard and give more space for the residents to use there instead. Had the garage been in the south

wing, cars would have taken over most of the courtyard. Using different materials on the ground – cobblestone for the courtyard and gravel for the car path and garage – creates a boarder between the space for cars and the space for people, limiting the cars to the east side.

Another reason for this decision is to do minimal intervention to the trees and other vegetation growing in the east garden. If there were to be dwellings there, a lot more trees would have to be cut down to make room for the private gardens, but with the garage and the shared garden there, it is more suited to have a wild vegetation and let nature take its place, and thereby decreasing the needed maintenance in the shared garden.

At the end of this project, a suggestion was given to me to replace parts, or all, of the garare with a greenhouse instead. I think this was a wonderful suggestion, as it could have made the new addition even more attractive, and it would most likely have been used more frequently by the residents. Had this suggestion come to me earlier, I would probably looked into it more, and maybe moved parking to the outside of the enclosed farmhouse, somewhere in the east of the site. It would have given the residents much more shared space, both to socialise and to tend to hobbies such as planting and farming, in a much more inviting milieu. If I were to continue the work on this project, this is the first thing I would look into, together with the garden and outdoor space in general. It would lead me to develop the social sustainability aspect even further.

When starting the design work, I tried to preserve as much as possible, one of the bigger things I wished to preserve were the brick blocks for the chimneys, since they can be a great quality in a home. I did a lot of different sketches to try and make it work, but unfortunately their placement were in conflict with the floorplans of the dwellings. I think the reason I had so much trouble with it was because of the size of the dwellings, given that they are rather small. The decision to keep the dwellings small is based on the number of dwellings that fit into the farmhouse, to promote social sustainability in the community (not too many, not too few). Therefore, after many different sketches and approaches, I decided to remove the brick blocks for the chimneys, in order to get better floorplans in the dwellings.

One of my personal thoughts when doing this design project is if this would really work if it were to actually be built. My main concern would be if the neighbours didn't get along. I believe that small communities like this one will become very personal, where all the residents know each other. If one of them didn't like their neighbours, or if the neighbours didn't like them, I think eventually a conflict would arise. In this small community there is no place to "hide", you can't remain anonymous or blend into the masses, since beside the farmhouse, there aren't any other neighbours too close-by. And if a conflict were to arise, if not solved relatively quickly, it could sour the whole atmosphere among the residents. Clarity regarding responsibilities, shared spaces and tools, shared functions, and respecting privacy is essential for a good climate in a

small community, and could help prevent possible disagreements.

Another concern is the necessity of a car. Ideally, a car would not be needed. But given the lack of public transportation in the nearby area, I think it is difficult to get by without one. Not impossible, but difficult. One option could be to try and get the municipality, or whoever is responsible for public transport, to cooperate and create new routes for a bus to pass here, since the demand would be bigger when multiple families move in. But most likely that would be difficult to achieve. This situation is important for residents to consider before moving here.

To conclude the thesis, and answer the research question:

How can the transformation of large farmhouses in rural Sweden contribute to sustainable development by creating multi-residential communities, while preserving the cultural heritage of these buildings?

The design project itself is one possible answer to the question, where the transformation of the farmhouse deals with both sustainable development and the preservation of heritage.

To make this more concrete – the transformation contributes to sustainable development by renovating an old building, giving it a new purpose and extended life. It contributes to sustainable development by reusing material and respecting the

material and nature already in place. And it contributes to sustainable development by designing a community to promote social sustainability and wellbeing.

I think this project could be used as a templet model for other farmhouse transformations, though an individual inventory and analysis would be needed to identify each farmhouse's heritage and qualities to preserve.

REFERENCE LIST

Literature

Carson, D. A., Carson, D. B., & Argent, N. (2022, July). Cities, hinterlands and disconnected urban-rural development: Perspectives from sparsely populated areas. *Journal of Rural Studies*, 93, 104–111. <https://doi.org/10.1016/j.jrurstud.2022.05.012>

Cattaneo, T., Giorgi, E., Flores, M., & Barquero, V. (2020, October 17). Territorial Effects of Shared-Living Heritage Regeneration. *Sustainability*, 12(20), 8616. <https://doi.org/10.3390/su12208616>

Cheng, L., Bae, Y., & Horton, W. T. (2019, January). A system-level approach for designing multi-family sustainable and energy-efficient housing communities. *Sustainable Cities and Society*, 44, 183–194. <https://doi.org/10.1016/j.scs.2018.09.017>

Gehl, I. (1971) *Bo-miljø*. Köpenhamn: Statens byggeforskningsinstitut.

Hillier, B., Hanson, J., and Graham, H. (1987) *Ideas are in Things: An Application of the Space Syntax Method to Discovering House Genotypes* <https://doi.org/10.1068/b140363>

Eimermann, M., Adjei, E. K., Bjarnason, T., & Lundmark, L. (2022, February). Exploring population redistribution at sub-municipal levels – Microubanisation and messy migration in Sweden's high North. *Journal of Rural Studies*, 90, 93–103. <https://doi.org/10.1016/j.jrurstud.2022.01.010>

Högberg, L., Lind, H., & Grange, K. (2009, December 16). Incentives for Improving Energy Efficiency When Renovating Large-Scale Housing Estates: A Case Study of the Swedish Million Homes Programme. *Sustainability*, 1(4), 1349–1365. <https://doi.org/10.3390/su1041349>

Nocca, F. (2017, October 19). The Role of Cultural Heritage in Sustainable Development: Multidimensional Indicators as Decision-Making Tool. *Sustainability*, 9(10), 1882. <https://doi.org/10.3390/su9101882>

Nylander, O. (1998). *Bostaden som arkitektur*. Göteborg: Chalmers university press.

Nylander, O., Forshed, K. (2011). *Bostadens omätbara värden*. HSB Riksförbund.

Olsson, S., Sondés, G., Ohlander, M. (1997) *Det lilla grannskapet – gårdar, trapphus & socialt liv*. Göteborg: Chalmers tekniska högskola. Centrum för Bostadskultur.

Peters, K. (2016) Social sustainability in context: rediscovering Ingrid Gehl's Bo-miljø. *Arq. Architectural Research Quarterly*, 20(4), 371–380. <https://doi.org/10.1017/s1359135516000488>

Torgny, O. (1984, January 1). *Skånelängor*. Liberförlag.

Veneri, P., & Ruiz, V. (2015, November 5). Urban-to-rural population growth linkages. *Journal of Regional*

Science, 56(1), 3–24. <https://doi.org/10.1111/jors.12236>

Åkerman, A. (2020) *En Annan Landsbygd*. Malmö: Rian Designmuseum

Statistics

Bostadsbyggnader efter region och byggnadstyp. Vart 5:e år 2010 - 2022-Statistikdatabasen. (n.d.). Statistikdatabasen. https://www.statistikdatabasen.scb.se/pxweb/sv/ssd/START__MI__MIO803__MIO803B/BostadsbyggnadN/table/tableViewLayout2/

Byggnader i och utanför tätorter, antal och markyta, efter region. År 2010 - 2020-Statistikdatabasen. (n.d.). Statistikdatabasen. https://www.statistikdatabasen.scb.se/pxweb/sv/ssd/START__MI__MIO810__MIO810B/ByggluchUtanfTatort/table/tableViewLayout1/



Erika Perleroth

Master thesis 2024

Chalmers School of Architecture

Department of Architecture and Civil Engineering