

GRÄNSLAND

infrastructure for ecotourism in a northern landscape

Lisa Weiss | Urban Challenges | Chalmers University of Technology
Examiner: Joaquim Tarrasó | Supervisor: Kengo Skorick

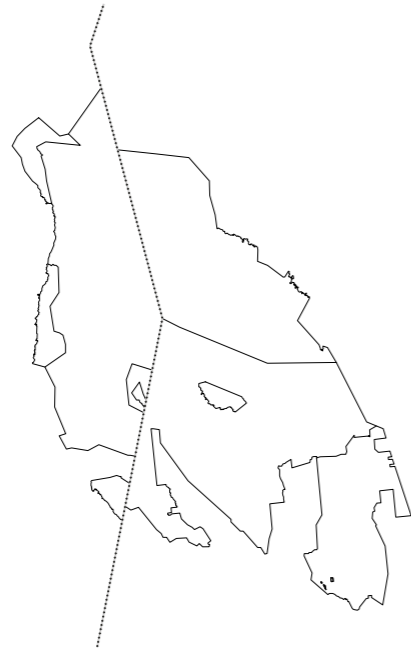

GRÄNSLAND

infrastructure for ecotourism in a northern landscape

Gränsland

Lisa Weiss | Urban Challenges | 2020
Architecture and Urban Design
Chalmers University of Technology
Examiner: Joaquim Tarrasó
Supervisor: Kengo Skorick



Gränsland means borderland. It refers to the chosen site, an area of protected nature situated in the middle of Sweden and Norway, crossing over the border of the two countries. It also refers to the fact that the area is a piece of seemingly untouched nature. No roads and no buildings can be seen for miles. It is an outpost of wilderness where humans are the visitors. A place far away from urban life.



Abstract

In Scandinavia one of our main tourism attractions is the wild and beautiful landscape. There has recently been a visible increase in the interest in nature tourism and outdoor activities. Sweden and its neighbour Norway have a lot to offer when it comes to nature experiences and the wish to spend your holidays in a sustainable way. This thesis is a proposal for how a specific area can be improved to make ecotourism more appealing and accessible to a wider range of people. A destination situated in the southern tip of the Scandinavian Mountains, that already is accessible by sustainable ways of transport, and already a popular spot for outdoor life and nature adventures, is enhanced by a new system of infrastructure for ecotourism. This way the current infrastructure and trail network will be reinforced. Providing new ways of staying in, and enjoying nature, in a sustainable and respectful way towards the environment and

the wildlife. It is also hoping to strengthen the connections across the Swedish-Norwegian border. A way for people to get a time out from their busy urban lifestyles and enjoy nature based on their own requirements. The architectural installations are focused around the identity of the site and helping to strengthen the perception of it being one territory without visible borders. References used include the local site history, artwork and ideas from the national romanticism period and capturing a feeling of what is Nordic and how there is a link between community and nature. A low impact on the site, connecting the area, a lower comfort level and sustainable solutions have been the foundations for the design. This thesis hopes to promote a greater appreciation for the Nordic landscape and how gently placed architecture can change the way we travel and choose to spend more time in nature.

| | | | |
|----|--------------|----------------------------------|----|
| 01 | Introduction | Abstract | 5 |
| | | Personal Background | 7 |
| | | Thesis Question | 8 |
| | | Background | 9 |
| | | Manifesto | 10 |
| | | Time plan + Reading instructions | 11 |
| 02 | Context | Context | 12 |
| | | Capturing the Nordic feeling | 14 |
| | | The Site | 16 |
| | | Site History | 18 |
| | | Landscape | 20 |
| | | Weather + Seasons | 22 |
| | | Tourism | 24 |
| | | Nature Protection | 26 |
| 03 | Concept | Concept | 28 |
| | | Delimitations + Definition | 30 |
| | | Approach | 31 |
| | | Scales | 32 |
| | | Impressions | 33 |
| | | The System | 34 |
| 04 | Process | Process | 36 |
| | | Architecture vs Nature | 38 |
| | | Planning | 40 |
| | | The Matrix | 42 |
| | | Materials + Structure | 46 |
| | | Construction | 47 |
| | | Design process | 48 |
| 05 | Proposal | Proposal | 52 |
| | | New Site Plan | 54 |
| | | System interaction | 56 |
| | | The Cabin | 58 |
| | | The Observation Shelter | 62 |
| | | The Border Station | 66 |
| 06 | Conclusion | Conclusion | 78 |
| | | References | 80 |
| | Appendix | | |

Personal background

When I was about 2 years old my parents took me on my first hiking trip in the Swedish mountains. They packed all we needed for three days out in the wild without closeness to any civilization. One parent carried me in a baby carrier on the back and the other the tent, sleeping bags, camping stove and all the other equipment needed. I of course have no memories of this particular trip. But there were many more to come! When my friends went on summer vacation to warm beaches in southern Europe my family would go to northern Sweden or Norway to go camping and hiking in nature. This idea of what a vacation well spent is has of course been stuck with me. It has given me much knowledge and appreciation for the landscape of my home country, Sweden, and its neighbour Norway.

In my thesis I combined my personal interest in outdoor life and the aim to promote more sustainable tourism by staying closer to home and exploring a place in nature. The purpose is to by architectural installations make nature experiences and ecotourism more accessible and appealing to people. A way for people to reconnect with nature and feel that they are also a part of it.

Subjects: ecotourism, outdoor life, tourism infrastructure, Swedish and Norwegian mountain landscape, sustainability

Master

MPARC | CTH, Gothenburg
Erasmus+ | UdK, Berlin

Bachelor

CTH, Gothenburg

Internships

Liljewall Arkitekter
Rstudio for Architecture



“How can a system of architectural installations in nature create a sense of identity for the chosen territory and make it more accessible for nature tourism?”

Aim

The aim for the thesis is to make a design proposal for a system of architectural installations placed in nature. They will form an infrastructure for ecotourism that creates identity, giving the site the feeling of being one territory, connecting different trail destinations with each other and by this making a stay in nature easier for people. A way to get people out there by fulfilling the basic needs for shelter and accessibility. The aim is for the architecture to have as small impact on the site as possible but also to function as landmarks. The installations will be based on sustainable and local materials and building techniques that can be assembled without the need for heavy machinery.

Methods

The initial part of the process was focused on careful mapping and research of the chosen site. Understanding the context on many different scales. Early on I did a study trip to the area and spent time in nature on the same premises as I set for the design. At the site I interviewed people working with nature tourism in the area to get input about how they would like a possible development of the chosen site. This was followed up by a close interaction between design work and analysis, defining a concept based on the analytical research outcome. Creating design tools and doing experiments focusing on the relationship between architecture, nature and the specific context.

Background

Scandinavia, wilderness and recreation are words that I think many people will see a connection between. In *Ecotourism in Scandinavia* the authors state that the widespread stereotypical image of tourism in Scandinavia is one of outdoor activities in vast areas of nature. An image that can be proven to be true as the concept of outdoor life is deeply implemented into the Scandinavian society (Gössling & Hultman, 2006). In *Sveriges Naturum* Mark Isitt (2013) even describes the Swedish peoples “hankering for the wilderness” as if it being part of our DNA. Something that could also apply for the Norwegians, were the individual connection to the countryside is oftentimes very strong (Gössling, Hultman, 2006).

Kjell Vowels (2017), writer of *Stuglandet*, a book about free-to-use cabins in Swedish nature, describes how Sweden was the first country in Europe to protect valuable parts of nature by making them into national parks in 1909. This coincided with times of strong romantic nationalism in Sweden and the romanticizing of rural areas playing a major part of it. When people started leaving the countryside for more urban settlements during the industrial revolution it became important to not forget the connection to nature. This having both moral and health related causes within society. To be good and healthy citizens it was important to spend time in nature.

Today it has become easier for people to go to places much further away when spending their holidays. Going abroad on vacation is something Swedes do nearly every year (Tillväxtverket, 2018). Yet a rise in the interest in nature tourism and environmentally friendly travel can clearly be seen in Sweden. The number of visitors to the STF run accommodations in the Scandinavian Mountains increased by 8% in 2019 compared to 2018 (Bergstedt, 2019). But there are socioeconomic differences between people who spend time in nature and people who don't. According to Vowels

not spending much time in nature can be the result of a person's income. Studies show that people who make less than 11 000 SEK a month spend less time in nature compared to the overall population. Another reason can also be that people who are not familiar with outdoor activities are less inclined to try it on their own simply because of their lack of knowledge. This is where information about outdoor life, accessible accommodation and infrastructure for ecotourism become important (Vowels, 2017).

The main focus for this thesis is therefore to make sustainable tourism more appealing for people living in or close to Sweden and Norway. Visiting new places and seeing astonishing landscapes is possible without having to fly halfway around the globe. The chosen site is an area of protected nature crossing over the border of Norway and Sweden. It lies at the southern end of the Scandinavian mountain range (in Swedish commonly called *Fjällen*). The site already is a popular spot in Sweden when it comes to outdoor tourism such as hiking and cross-country skiing. Though today most of the activities are centred around just small parts of the whole area. This might be due to the lack of tourism infrastructure in other parts.

In *Sveriges Naturum* Claes Caldenby (2013) argues for how architecture can function as a steppingstone between the humanly controlled (culture) and nature. He calls this “slash architecture”, architecture functioning as the slash sign between nature and culture. In connection to this he also talks about the common perception of Nordic architecture being closely linked to nature and landscape.

The thesis will therefore focus on enhancing the chosen area to attract people to stay in nature, make the nature experiences more accessible, interesting and inspiring by architectural installations. The design is meant to promote a consciousness about our place in nature, the effects of climate change and to make people appreciate the Nordic landscape more.

WHAT?

A system of infrastructure for ecotourism that provides shelter and makes the area accessible for visitors.

WHY?

To promote eco-friendly tourism and strengthen the identity of an area of protected wilderness.

WHERE?

In *Gränslandet*, an area of protected nature in the Scandinavian Mountains crossing over the border between Norway and Sweden.

HOW?

Designing the installations based on careful mapping, creating a strong relationship between design and context. Having as small impacts as possible in mind the whole time. Working with sustainable materials and building techniques.

WHO?

For people that want to explore nature and enjoy the freedom of being in the wilderness. They are willing to accept a low level of comfort and be respectful towards nature and wildlife.

January

Finalize Project Plan

13.1 Hand in Project Plan

20.1 Introduction Meeting 20.1 - 21.1 Start-Up with Direction

Mapping + Site Research

February

Plan Site Visit + Study Trip

Site Visit + Study Trip

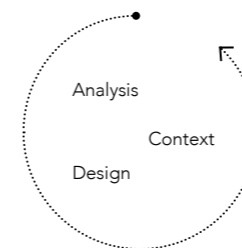

March

Prepare Mid Term material

27.3 Mid Term Seminar

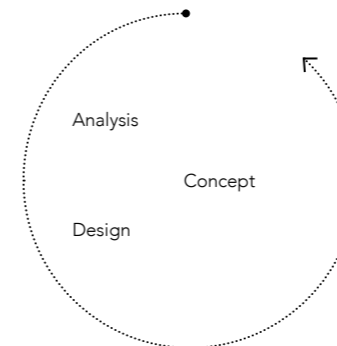

April

Finalize design

Prepare Final Seminar material

May

20.5 Final Seminar

Conclude material

June

11.6 Final Deliverance

Reading instructions

01 Introduction

Here the discourse is introduced. The *thesis question* is presented, and its relevance is explained by references and statements. As well as the *aim* and *methods* used, a *written manifesto*, a *time plan* for the semester and a *vocabulary* with commonly used terms.

02 Context

In this chapter the chosen site is presented along with analytical research explaining the context.

03 Concept

A description of how the discourse and context research were used to define a concept for the thesis.

04 Process

The design process and its methods and strategies used for doing design research are shown.

05 Proposal

In this chapter the design outcome and how it responds to the thesis question is presented.

06 Conclusion

Holds a brief reflection on the work that was done and how it relates to the thesis question and aim.

Vocabulary

ecotourism

Nature based recreational travel with preservation and sustainability in mind.

tourism infrastructure

The infrastructure needed to perform tourism in an area. In this situation accommodation, trails, walkways, bridges, signs etc.

outdoor life / activities

Swedish / Norwegian: *friluftsliv*. Recreational activities performed in nature, such as hiking, skiing or fishing.

off-the-grid

A place that is rural and not connected to public utilities such as electricity or water supply.

county administrative board

Swedish: *länsstyrelse*. The governing authority in a Swedish county (*län*). Responsible for maintenance and regulation of areas of protected nature.

county governor

Norwegian: *fylkesmannen*. Local state representative in a Norwegian County.

STF (Svenska Turistföreningen)

The Swedish Tourist association. They promote outdoor activities and maintain many trails, cabins and hostels in Sweden, especially in the mountains.

DNT (Den Norske Turistforening)

The Norwegian equivalent to STF. Maintaining trails, huts and cabins.



Context

The site called *Gränslandet* (meaning the borderland) is situated in the middle of the Scandinavian Peninsula on the southern tip of the Scandinavian Mountain range. It covers more than 2000 km² and consists of nine areas of protected nature. Four of them are in Sweden and five in Norway. It is a land without roads or any clear signs of civilization except for the few tourist cabins and wind shelters. Because of this it is a popular spot for outdoor activities such as hiking, skiing, kayaking or fishing. A place to get away from the urban stress. Yet it is not really the untouched nature it appears to be, small numbers of people have been living in the area for thousands of years hunting, farming, herding reindeer or working as timbermen (Gränslandet, 2011).

Capturing the Nordic feeling

One of the starting points for defining a wider context, beyond just the chosen site, has been how to capture a feeling of what is Nordic. In *Sverige: Ljus och landskap*, texts by Tommy Hammarström accompany photographs of the Swedish landscape. In the chapter about the mountain landscape, *Fjällen*, he describes how it can be defined as the last remaining real European wilderness. He describes the feeling of the nature by using four words: silence, expanse, vastness and loneliness (Hammarström, 2001). These four words can also be applied to many paintings depicting Nordic landscapes created during the romantic nationalism period in Scandinavian art history. As for instance many works done by Karl Nordström, Bruno Liljefors or Carl Larsson show views of landscapes with a kind of melancholic touch to them. The painters often pay a tribute to and romanticize the rural parts of Scandinavian society. Peasants and workers and their environments were common motives at this time (Rosenblad & Söderholm, 2014). The paintings from this era and their vernacular expression of it can serve as a good reference for describing the feeling of what is *Nordic*. As stated by Nordic design pioneer Ellen Key, when it comes to what is good design it is about the beauty in function and simplicity. It is not about being spectacular or extravagant, but rather what is the most adequate solution in the given situation. This not saying that Scandinavian design is without beauty (Key, 1913).

When it comes to buildings placed in the harsh environment of the Scandinavian mountains most are based upon a clear function and purpose rather than a certain design prospect. Especially when it comes to historical buildings, they are often built from local materials and built in a way that adapts to the weather conditions. John Åkerlund (1884-1961) is famous in Sweden for being the architect behind many of the most visited mountain stations (*fjällstation*) in the Scandinavian Mountains on the Swedish side. His focus point when designing was always a strong link to a site's cultural and natural identity in order for it to blend in well with its surroundings. He always had the visitor in mind and wanted to create a sense of cosiness and community within the buildings. These historical buildings have become linked to the identity of the places they are built in. They have become a part of its soul (Kindblom, Kindblom & Bergquist, 2002). This idea of what is Nordic and how to capture the identity of a place is what has become the wider context for the thesis. Simplicity, function and adaptability to the context make up the foundation for the design outcome.



Figure 1. Höstbacke med räv (Autumn hill with a fox), oil painting (Liljefors, 1919) CC-BY

Figure 2. Harvesting ice blocks (Larsson, 1905) CC-BY

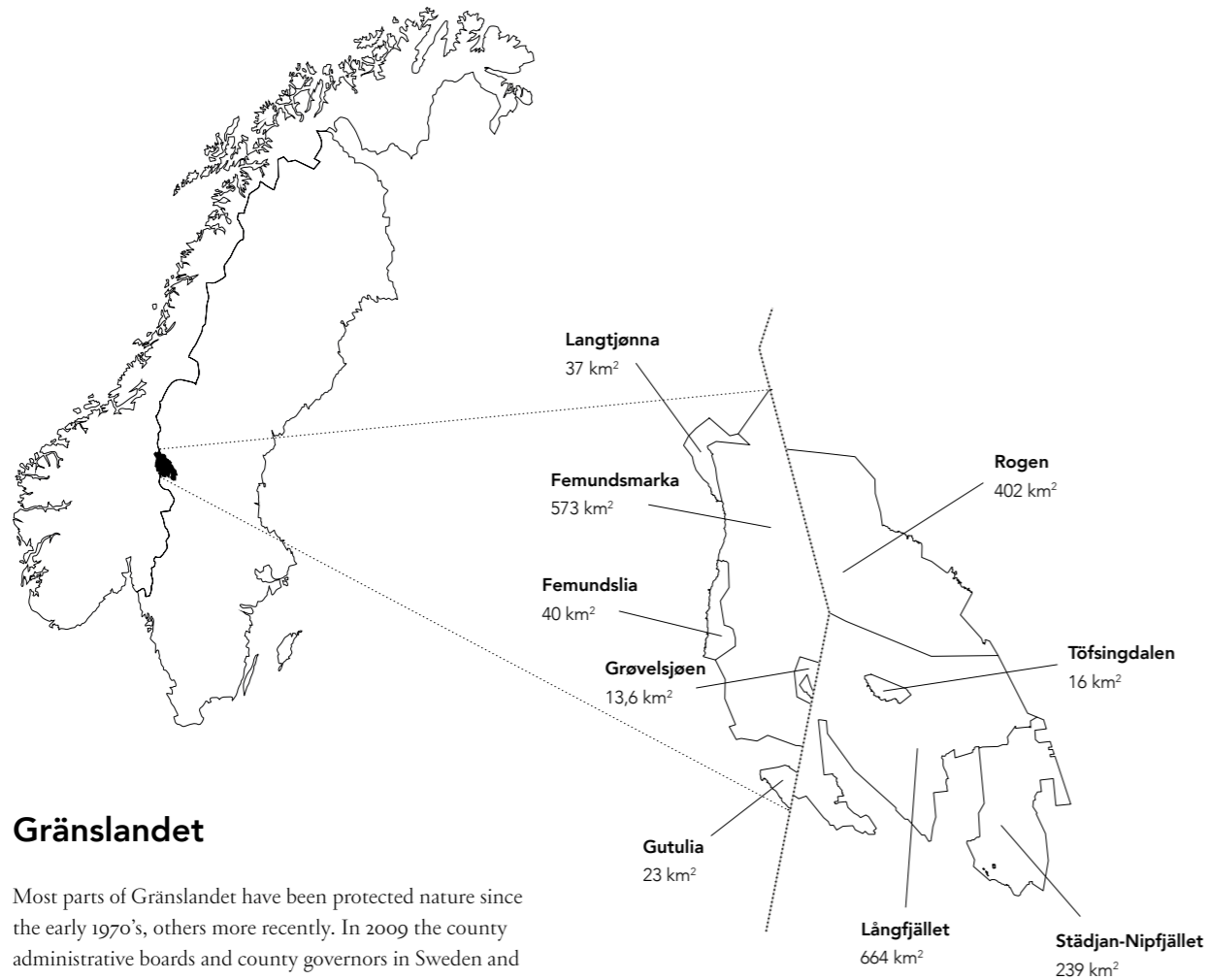

Gränslandet

Most parts of Gränslandet have been protected nature since the early 1970's, others more recently. In 2009 the county administrative boards and county governors in Sweden and Norway started an information project about the whole area that they decided to call *Gränslandet*. The main purpose of the project was to improve the possibilities for and provide better information about nature tourism and outdoor activities, reduce the wear and tear on the landscape, create a greater understanding and consideration for reindeer herding and spread knowledge about nature preservation. They did this by creating a website and information folders, putting up signs at the entrances and on special locations in the area and by closer collaboration between the municipalities (Gränslandet, 2011). Most of the knowledge about the site that will be presented here comes from the website about the Gränslandet project.

My own experience

I have visited the area around Grøvelsjön many times since I was a small child. We would go skiing in winter and hiking in the summer times. I have always found the landscape stunningly beautiful at every season. The seasonal change is very clear and completely changes the perception of and possibilities for activities around the area. Since it lies so close to the border to Norway, I have often skied up the mountain on the western side and into Norway. The only thing that marks the border is a reindeer fence put up by the Sami. Unfortunately, the trail network with cabins and shelters does not connect the two countries in more than two places in the whole area of Gränslandet. Therefore, one focus point of the thesis proposal is to strengthen the possibilities to cross the border and experience the landscape in both countries.

- Hotel | Hostel | Mountain station
- Tourist Cabin
- Unstaffed Tourist Cabin
- Emergency hut
- Open hut
- Wind shelter
- Contour lines
- Built-up area
- Forest
- Marsh | Bog | Mire
- Lake
- National boundary
- Nature protection boundary
- Marked summer and winter trail
- Marked summer trail
- Marked winter trail
- Marked trail on ice
- Boat route
- Bigger road
- River

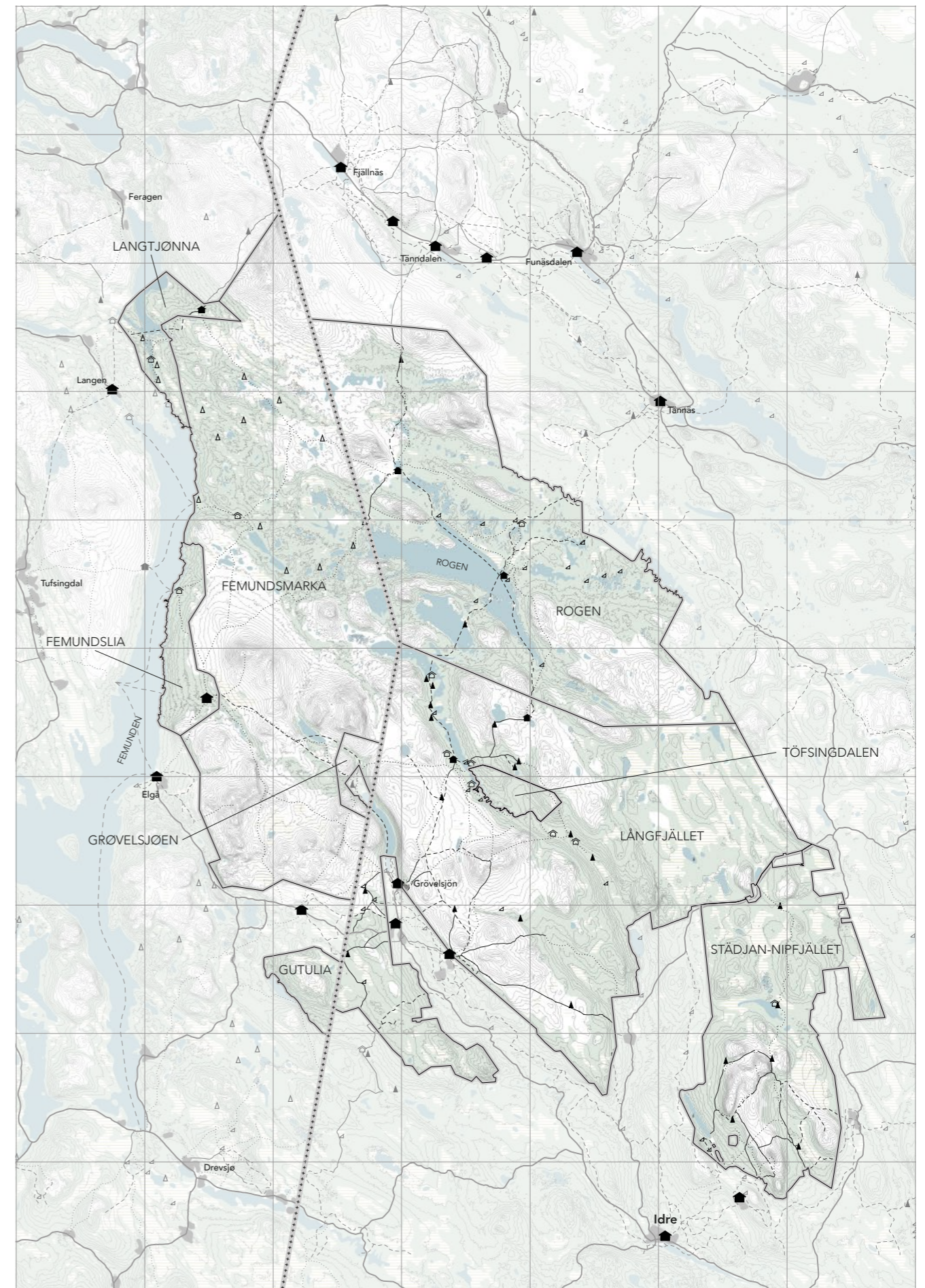

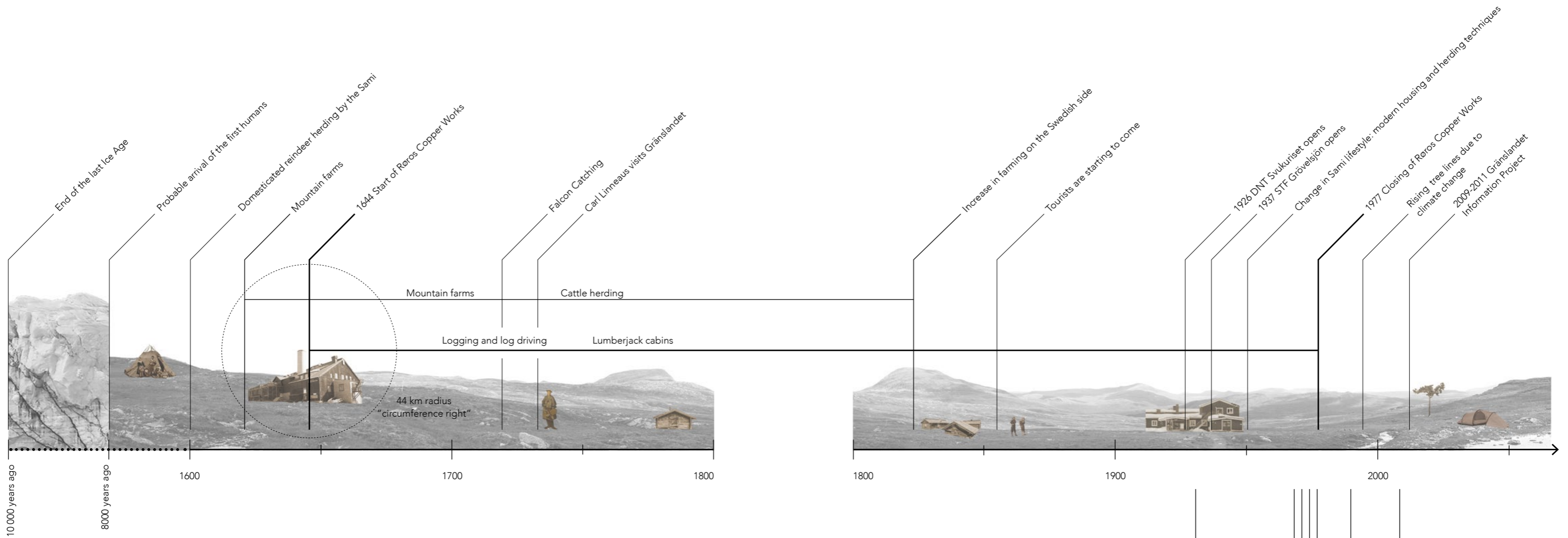

Site history

On their Gränslandet information website (2011) the county administrative boards and county governors describe the history and development of the area in great detail. One can say that the land was reborn when the inland ice from the last ice age melted away and left the landscape clearly marked by it. Traces that the ice left can be seen everywhere still today. The rounded shapes of the mountain tops, meltwater ridges and vast boulder terrain are some examples. It is estimated that the first people arrived here around 8000 years ago, living of the land by hunting and fishing. The Sami, being the indigenous people of Northern Scandinavia, have been living in the area for centuries. They learnt to domesticate reindeer and lived in the area completely adapting to the

seasons and the reindeer lifecycle. Later, other people also tried farming, mostly engaging in cattle herding due to the ground being so poor in nutrients making it difficult to grow crops. The look of the land has also been largely influenced by the nearby Røros Copper Works. Huge amounts of timber were needed to keep the furnaces burning day and night, all trees within a 44 km radius from Røros where chopped down. This was called the circumference right. Traces of logging and some lumberjack cabins are still existent in the area. Today the land is protected by nature protection laws and the people that come here come as tourists. Apart from the small Sami communities keeping reindeer nobody really lives of the land anymore (Gränslandet, 2011).

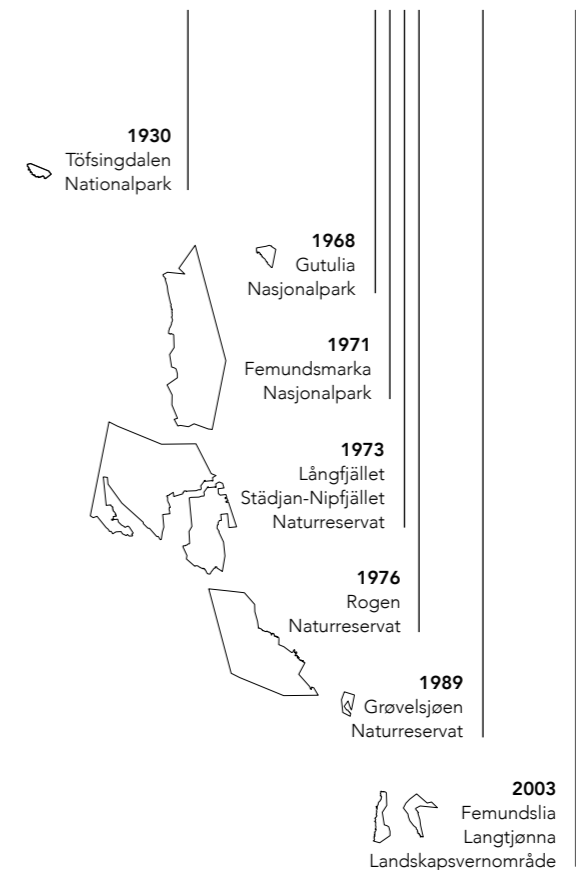



Bare mountain



Bare mountain landscape above the tree line. Large boulder fields and small traces of vegetation.



Marsh



Bogs and mires scattered across the landscape appear in many places except on higher altitudes and where the ground is particularly rocky.



Sparse mountain forest



Close to the tree line grow small weathered birches and pines, some more than 700 years old.



Forest



Denser forest mostly consisting of pine and spruce trees growing further below the tree line in the more temperate valleys.



Lakes



Many smaller and bigger lakes intertwine into one big lake system.

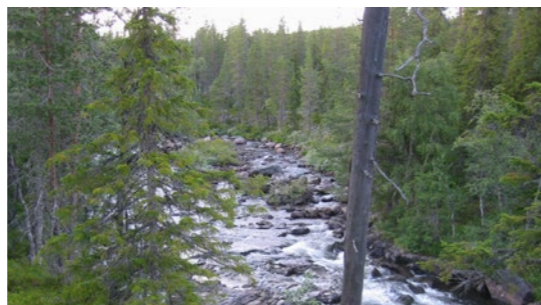

Rivers



Rivers can range from just small streams of melt-water along the mountain slopes to wild rapids more than 6 meters wide.



Sparse mountain forest in winter near Valdalsbygget, Norway

Landscape, flora and fauna

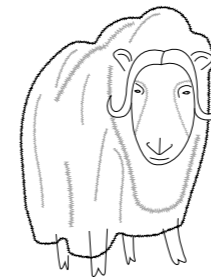

Sweden's only tribe of wild muskox live north of lake Rogan. The tribe is today expected to consist of 10 individuals. If you see one it is very important to keep your distance and not to disturb them!

The soil in the Scandinavian mountain range is poor in nutrients. This in addition to high altitudes and tough weather conditions have led to a special flora and fauna in the area. Most of the trees are small and weathered, their trunks get visibly twisted due to the slow growth. Since the area is protected by nature preservation laws none of the dead trees get removed. They remain as silver coloured skeletons, being home to many insects, birds and small rodents. At around 1000 meters above sea level it becomes difficult for most trees to grow. This visible border where the trees stop growing is therefore called the tree line. Trees growing close to this limit usually never grow taller than 1 to 2 meters. Higher up lies the so called *kalfjäll*, or bare mountain landscape. Here the vegetation is sparse, and the land mostly consists of fields of rocks and patches of snow and ice. Due to global warming the tree line is moving further up the mountain slopes. In the future there is a risk of the disappearance of bare mountain tops in the area when they will become covered by vegetation, disturbing the whole ecosystem (Gränslandet, 2011).



Snowed in emergency shelter at Särsjöbacken, Långfjället, Sweden (920 masl)

Weather and seasons

In the Scandinavian Mountains winter is the longest season, usually lasting from November until mid-April or May. Above the tree line, in bare mountain terrain, wind speed can become quite high and perform a danger for mountaineers being in the area at the time. Wind gusts moving the upper layer of snow, making the sight distance as short as 5 to 10 meters. Snow gets blown into piles that can cover usually perfectly visible structures such as the cabin pictured above. Therefore, it is of great importance to have emergency shelters that are visible and accessible in harsh weather conditions. In summer temperatures lie above 10 °C but it can still go below zero on cold nights. Weather data concerning seasonal length, temperature, wind and snow depth from 4 weather stations surrounding the area was collected. The data presented are average values. Since the stations lie outside of the most mountainous terrain it can be estimated that the actual weather conditions on the site would be extremer when it comes to cold temperatures, wind and snow depth.



Weather stations for data collection

Weather data based on observations from 4 weather stations surrounding the site, in a 5 year time span from 2015 to 2020. (Data collected from SMHI and YR).

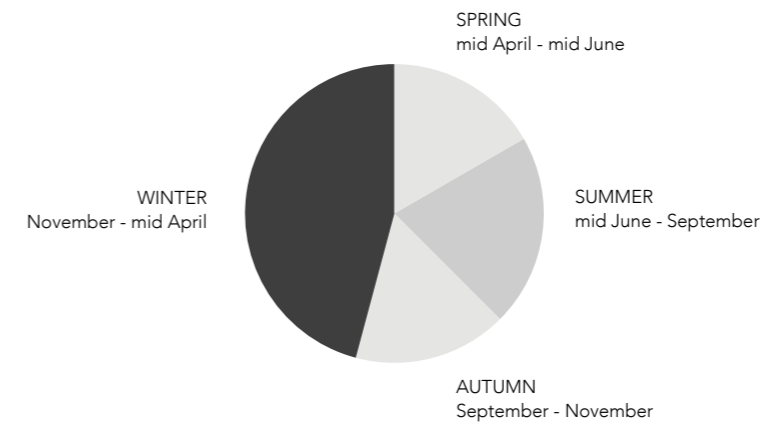

Seasons

Winter is the longest season, normally lasting longer than 5 months a year.

Definition of season start:
 Winter: < 0.0 °C for 5 days or longer
 Spring: > 0.0 °C for 7 days or longer
 Summer: > 10.0 °C for 5 days or longer
 Autumn: < 10.0 °C for 5 days or longer

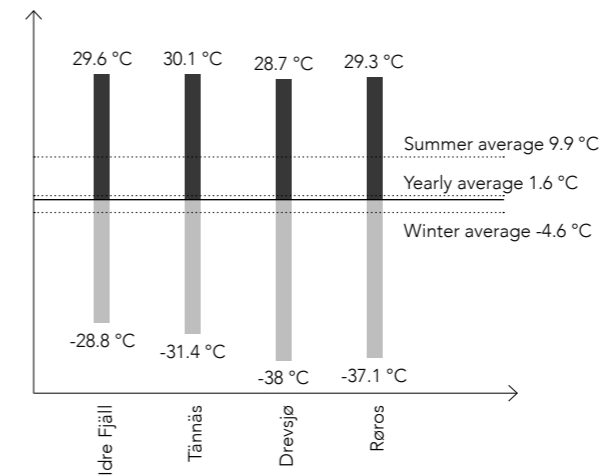

Temperature

Maximum temperature, minimum temperature and yearly average temperature.

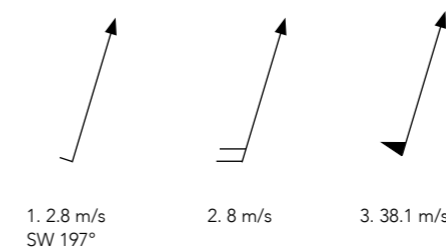

Wind

1. Average wind speed and direction
2. Average gust speed
3. Highest gust speed

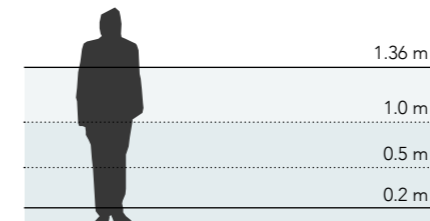

Snow depth

In winter the snow depth usually ranges from 0.5 to 1 meters. The yearly average is 0.2 m and the highest level measured is 1.36 m.



A typical wind shelter design in Gränslandet, called *Slogbod* in Swedish. They offer primitive shelter for shorter breaks and the possibility to stay overnight if you bring the right equipment according to weather conditions and temperature. There is usually the possibility to make an open fire if you bring firewood.

Windshelter



In Sweden small huts are placed along the trails between bigger accommodation options. They serve as shelters for shorter breaks or overnight stay in emergencies. There is a storage of dry food, firewood and an emergency phone. In Norway there are similar small huts (*Bu*), but with the difference that you are allowed to stay for free for one night. Not just in emergency situations.

Emergency Hut
Open Hut



Within Gränslandet where there are no roads or power lines there is the possibility to stay in a staffed or unstaffed cabin. The cabins have no electricity or tap water. You stay in a shared room where you get a bunk bed with mattress, pillow and blanket. Staffed cabins sometimes have a shop where you can restock on food.

Tourist Cabin



On the border to Gränslandet in the starting points of the trails there are some hotels, hostels and so-called mountain stations, Swedish: *Fjällstation*. They offer a more comfortable accommodation. In the mountain station you can rent equipment, join guided tours, relax in the sauna or enjoy a local and organic three-course dinner.

Hotel / Hostel
Mountain Station

Tourism

Most people that visit Gränslandet today come here as tourists longing for recreation and to enjoy nature. It is a popular spot for fishing, hiking and canoeing in the summer and skiing in the winter. Some might also try ice skating, kiting or mountain biking. There are different options for accommodation depending on people's needs and requirements. Surrounding the area are some more comfortable hotels and hostels. In the area you can choose to stay in a staffed tourist cabin. Or pre-book a smaller cabin and collect the key before you head out. In Norway there are lots of small, primitive huts called *Bu* (usually old lumberjack cabins) that you can stay in for one night free of charge. Then there is also the option of bringing your own tent. The main access point for tourists visiting the area is Grövelsjön situated in the southern parts on the Swedish side. From here trails leading in all directions make it possible for the visitor to go exploring wherever they like, staying in the area and just doing daily excursions or heading out for longer tours (Svenska Turistföreningen). Grövelsjön's Fjällstation, Tännaldalen and Tännäs are all accessible by public transport via bus from the closest train stations. The Norwegian parts can be accessed from the closest train station that is situated in Røros.

Available accommodation on site (close by)

- 1 (14) Hotel / Hostel
- 5 (1) Staffed cabin
- 12 (3) Unstaffed cabin
- 15 Open Hut
- 23 Emergency Hut
- 24 Windshelter

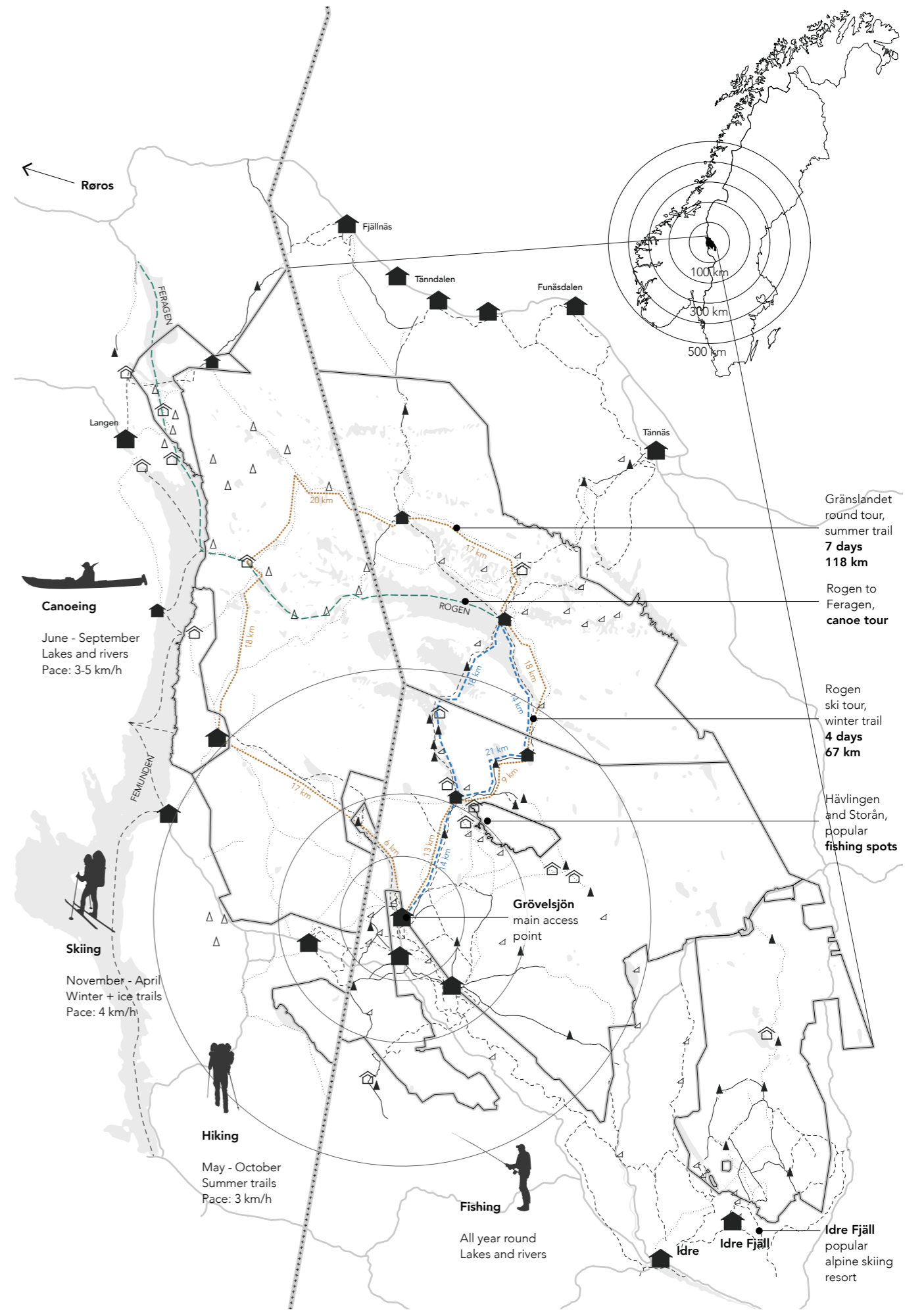

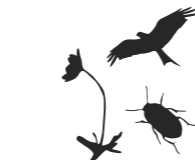
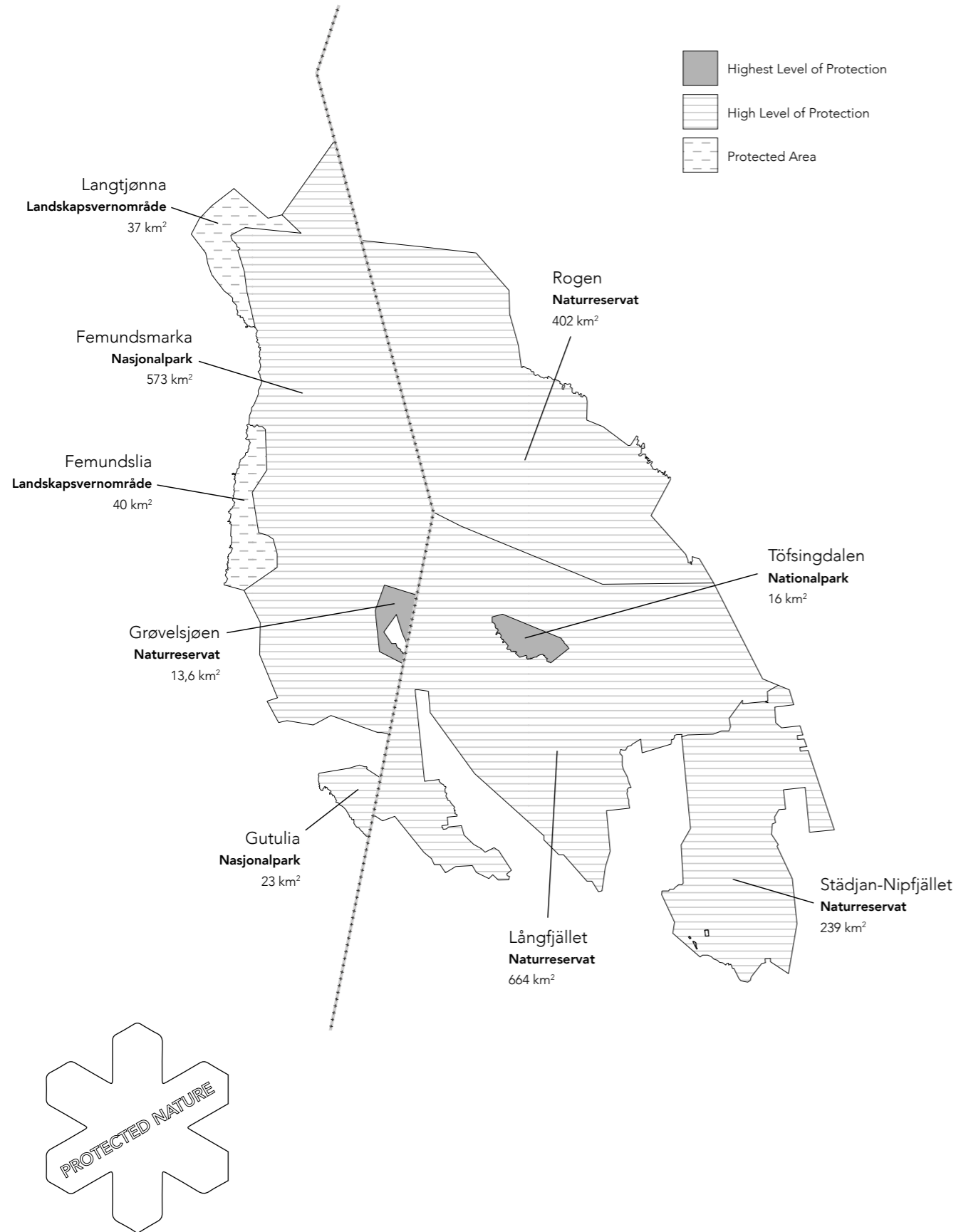

preserve biodiversity



preserve valuable natural environments



protect endangered species

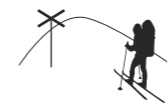

supply areas for outdoor activities

Nature protection

Nature protection in Norway

In Norway *Naturreservat* (nature reserve) is the strictest form of protection an area can get. Big areas of valuable and representative landscapes can become a *Nasjonalpark* (national park). Areas with the need for lesser protection can be made into a *Landskapsvernområde* (landscape protection area). Here it can still be allowed to use the land for farming or forestry but under certain conditions (www.miljodirektoratet.no).

Nature protection in Sweden

In Sweden a *Nationalpark* (national park) is the strictest form of protection. The purpose is mainly to preserve the areas natural state. The most common form of nature protection is a *Naturreservat* (nature reserve). Sweden has around 4000 nature reserves and together they make up 85% of all protected nature. Every nature reserve has its own regulations, there can also be different restrictions within an area (www.naturvardsverket.se).

Building in protected nature

The Swedish nature reserves all have their own management plans made by the local county administrative boards. Rogen, Långfjället and Städjan-Nipfjället have their own unique plans guiding how the areas are to be protected and maintained. The three different plans have similar regulations and were all applied within the early 1990's with some revisions made in the early 2000's. They all state that one of the reasons for protecting the areas by nature protection laws is to make outdoor activities in nature possible for the public. Normally, making bigger modifications to the land is not allowed, yet the county administrative boards can make exceptions for constructions related to outdoor life. Though it is of great importance that this does not interfere with nature protection! The need for preservation of flora, fauna and landscape always comes before the needs for tourism. The same goes for interventions that might disturb the Sami's reindeer keeping (Länsstyrelsen Jämtlands län, 1993, Länsstyrelsen Dalarna, 1992, 1994). Similar rules as for the Swedish nature reserves apply for Femundsmarka national park on the Norwegian side. Here the responsible maintenance agency can give permission for adding new buildings and constructions within the area as long as it does not violate the nature protection regulations (Lovdata, 2013).

When the maintenance plans were conducted, the number of visitors to certain parts of Gränslandet, like Rogen nature reserve, were rather low. Therefore, there was no foreseeable need for an extension of the available tourism infrastructure. Today, almost 30 years later, times have changed. The interest in nature tourism in Sweden is increasing. In 2012 the Swedish Government set up 10 goals for how to improve the availability and accessibility for outdoor activities close to nature. The main conditions for doing this are by providing access to nature and outdoor activities and offering a certain level of quality for nature experiences (www.naturvardsverket.se)



Concept

The analytical research on the context along with impressions from the study trip were used for defining the concept for the design proposal. The overall sense of 'what is Nordic' along with the identity of the specific site itself and its cultural and natural values were important. This chapter explains the delimitations of the discourse, the approach and arguments for doing what the thesis proposes as well as the definition of the tourism infrastructure system.

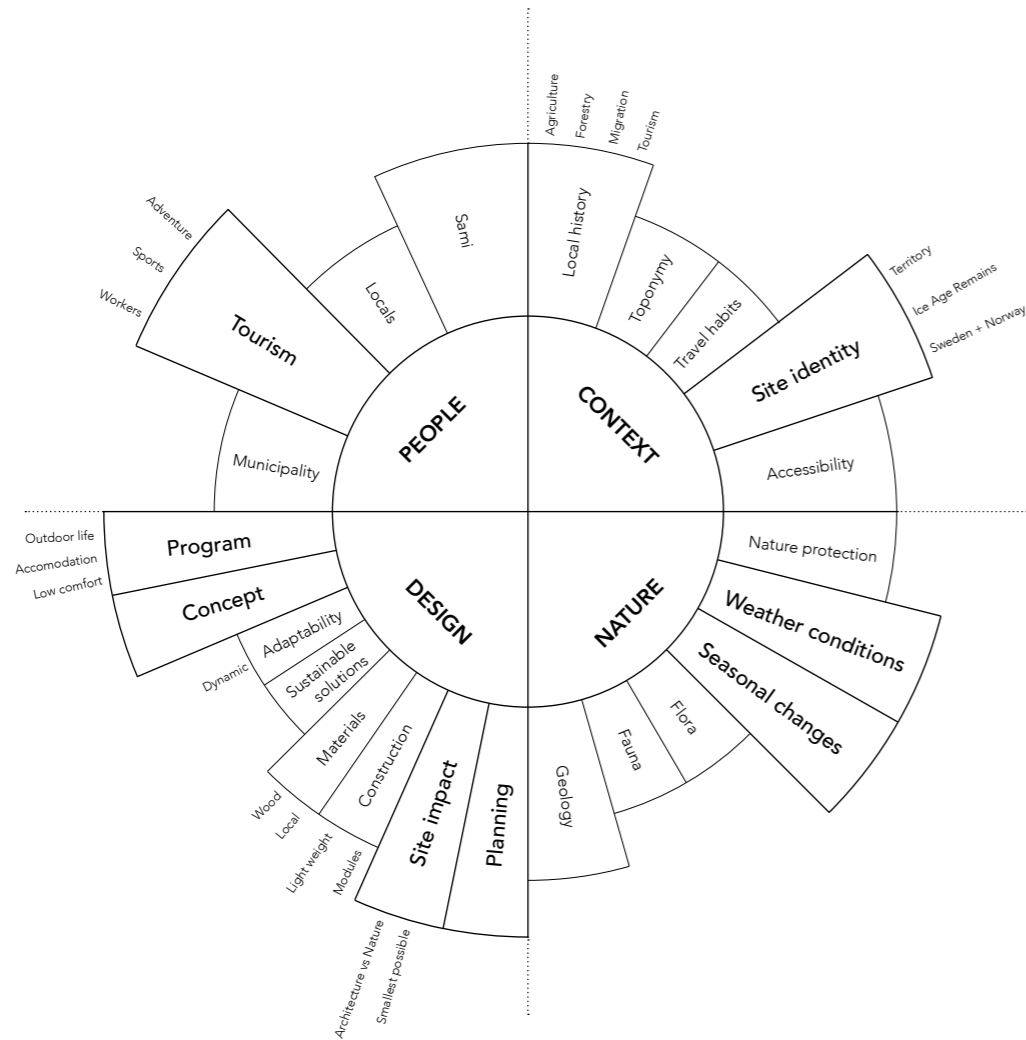

Defining a concept

One of the first questions that came up when introducing the thesis idea to other students and teachers at Chalmers was: But why should we build in (untouched) nature? This questions gives a direct insight into the discourse for the thesis. Because essentially, it is exactly the question that I had asked myself and that I wanted to explore deeper. Hoping that I could find a way of dealing with putting architecture into nature in a respectful, yet innovative, way that makes the chosen site into something more than just a far away spot of protected nature. A place that is not explored by many due to the lack of needed tourism infrastructure. As stated by Mark Isitt when writing about the Swedish national parks, one reason for making them into protected nature and promoting their existence by attractions such as information centres, constructed footpaths and signs is so that people become more eager to go there and feel like they have a right to it

(Isitt, 2013). What is aimed for here by doing a proposal for building in nature is to create a link between beautiful landscapes and built installations that together create an attraction for tourists. An example of where this is already put into practice is the National Tourist Routes project in Norway. It started in 1993 by an initiative from the Norwegian Public Roads Administration. The goal is to by 2024 having around 250 architectural installations along the most scenic roads across the country. They are meant to tie art and nature together (Løken, Dyrerud & Neste 2016). This thesis's proposal has a more sustainable approach, were people move through the landscape in a slower pace. A way to indulge in nature and the experience rather than just going from one attraction to the next. The proposed installations will serve as landmarks and as the infrastructure that provides the basic functions needed by people who come visiting.

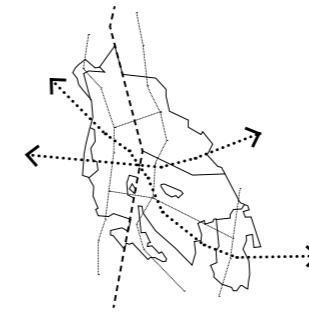

expand the trail network



make staying easier



create borderless identity

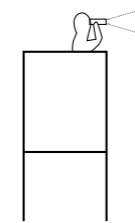

enhance visitor experience

Approach

When it comes to creating an overall approach, the main focus has been identity. What is the DNA of the place? The analysis done during the study trip tried to capture that. The place was deciphered on many different scales and layers. Looking at the human scale of accessibility, connections, appreciation and currently available accommodations and tourism infrastructure. As well as mapping the terrain, topography, changes in landscape in both big and small scale. Since the chosen site is located across the border of Norway and Sweden, there have been efforts made by the local counties to promote the area as one, creating a unified identity (Gränslandet, 2011). Yet, based on my own experience at the site and from talking to people living and working in the area, this has not really worked.

Carl Johan Ingeström, manager at Grövelsjön Mountain Station, says that more could be done to develop tourism in *Gränslandet*. He means that a way of doing this could be by adding a new form of simpler accommodation options that could attract a younger target group. A better connection to the popular mountain areas in Jämtland would also be desirable. Ingeström mentions that when it comes to mountain tourism in Sweden today the main focus areas are Jämtland and Northern Lapland, but *Gränslandet* also contains fantastic nature values that can be promoted. The name *Gränslandet*, given to the site by the local county administrations, is not well known amongst visitors today. Ingeström proposes that the name itself could play an important role when promoting the area in the future.

Based on this input the concept of the thesis is to strengthen and expand the trail network and reinforce the amount of available cabins and shelters. Creating a system of ecotourism infrastructure were the components are new accommodation options, creating better accessibility and connections. With an overall design concept that makes the components into architectural mates, kind of like the follies of an English garden, spread out within the site unifying it into one. Giving it the identity of being one territory with no visible borders. As stated by Ingeström: "If you do something that looks designed others will start to notice it [the area] as well. Not just the nature geeks."

01 Norway & Sweden

835 500 km²

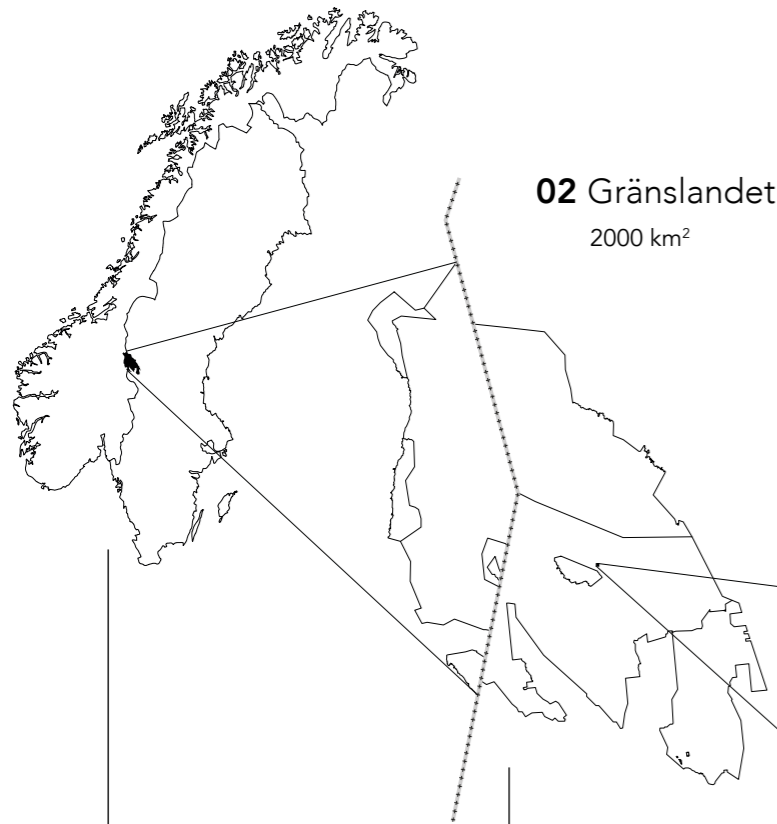

02 Gränlandet

2000 km²

03 Situation

16 000 m²

04 Building

10 m²

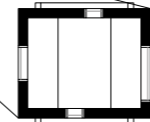
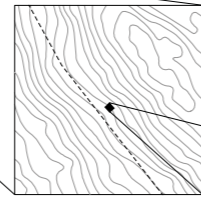

History
 Union 1814 - 1905
 Strong relationship with nature
 Use of the land and its resources

Landscape
 Norway: dramatic
 Sweden: expansive
 Taiga forest
 Scandinavian Mountains

Infrastructure
 Vast countries, big areas that are off-the-grid

People
 15,6 million inhabitants

History
 Reindeer keeping
 Mining
 Logging
 Cattle farming

Landscape
 Mountainous
 Barren

Infrastructure
 Trails
 Cabins

People
 Tourists
 Locals
 Sami

History
 Ice Age remains

Landscape
 Trees
 Rivers
 Rocks

Infrastructure
 Trail
 Shelter

People
 Tourists
 Maintenance staff

History
 Design related to context history

Landscape
 Adaptation to site
 Site impact

Infrastructure
 Functions
 Features

People
 Users



fireplace



meltwater



encounter



memory



silence



border



mosquitoes

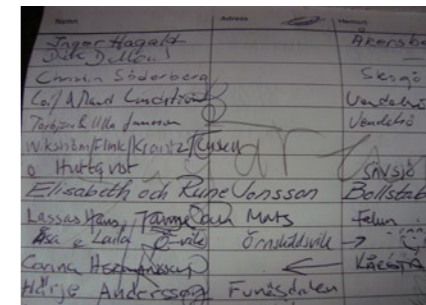

community



expanse



route

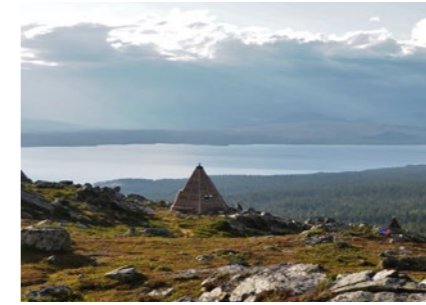

landmark



shelter

1. Figure 3. Brennhåmmåren, Norge med Femunden (Svanerud, 2019).

A new tourism infrastructure system



The Cabin

New open cabins are to serve as an option to bringing your own tent. They will be placed between the bigger accommodation options in the area and provide simple shelter for maximum 10 people. Similar as the open huts in Norway the new cabins will be free to use, with the difference that they will be better adapted to host bigger groups, their function in emergency situations as well as to be used for shorter daytime breaks.



The Observation Shelter

The observation shelter will be a completely new addition to the current infrastructure. They can be used for shorter daytime breaks and to get the visitor an elevated view of the landscape. They are to be placed in spots of particular interest, like a spectacular view or a trail intersection and serve as landmarks along the trails.

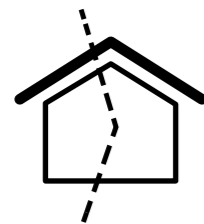

The Border Station

The border station becomes an in between option of tourist cabin and mountain station. It aims to provide simpler accommodation for 40-50 people. Placed at the border in a central location of the site it becomes a node for the trail network. It is supposed to function at all seasons and can be accessed by hiking, skiing and canoeing.

Currently available infrastructure



The Observation Shelter

New typology!



The Cabin

New in between accommodation options!



The Border Station



Process

The process has been a close interaction between analytical research and design research. Research has been done on many different scales and with different focus points. The aim of the research has been to create many different layers for the proposal to be based upon. In this chapter the methods used and the outcome of different explorations and investigations are presented. It starts with a design experiment related to architecture in nature, colours and shapes, and moves on to planning strategies on the bigger scale. Later the very objective definitions and categorization of the components is explained through the development of a design matrix. Which leads to the definition of a material, structure and construction concept for the whole system. Then each component and their individual references and design processes are explained.

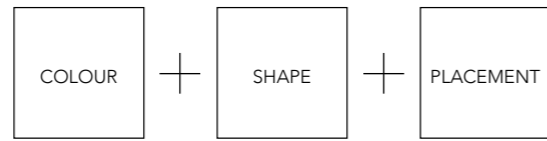

- | | | |
|--------------------|----------------|--------------------|
| blue | simple | elevated |
| purple | organic | integrated |
| pink | round | sunken |
| red | edgy | independent |
| orange | | |
| yellow | | |
| light green | | |
| dark green | | |
| brown | | |
| black | | |
| grey | | |
| white | | |

Architecture vs Nature

This experiment was done in the first 2 weeks of the thesis semester, prior to the study trip. The aim was to explore how it would be to put something built in a landscape like the chosen site, so that the findings and ideas could be kept in mind while spending time there. The focus point for this experiment was to see how shape and color would relate to the landscape in two different seasons, winter and summer. Combining a *colour*, a *shape* and a *placement* gave many small artefacts with different features. They were then placed in a winter setting and a summer setting to see how they would relate to the surrounding colours and shapes. All of them were photographed in the same angle and the photos were later edited so that

all artefacts could be compared in 12 different colours. This made it possible to look at only shape, only color or both combined, one at the time or next to each other. The outcome was that bright colours stand out more than earthy ones, this also depends on the season since the background would be white in winter and brown-green in summer. Red is a colour that in both seasons clearly stands out the most. While black stands out well in winter and blends in in summer. Shapes with straight edges in an elevated placement stand out more than organic shapes integrated into the surroundings. The findings from this exploration along with impressions from the site visit have influenced the features set for the design proposal.

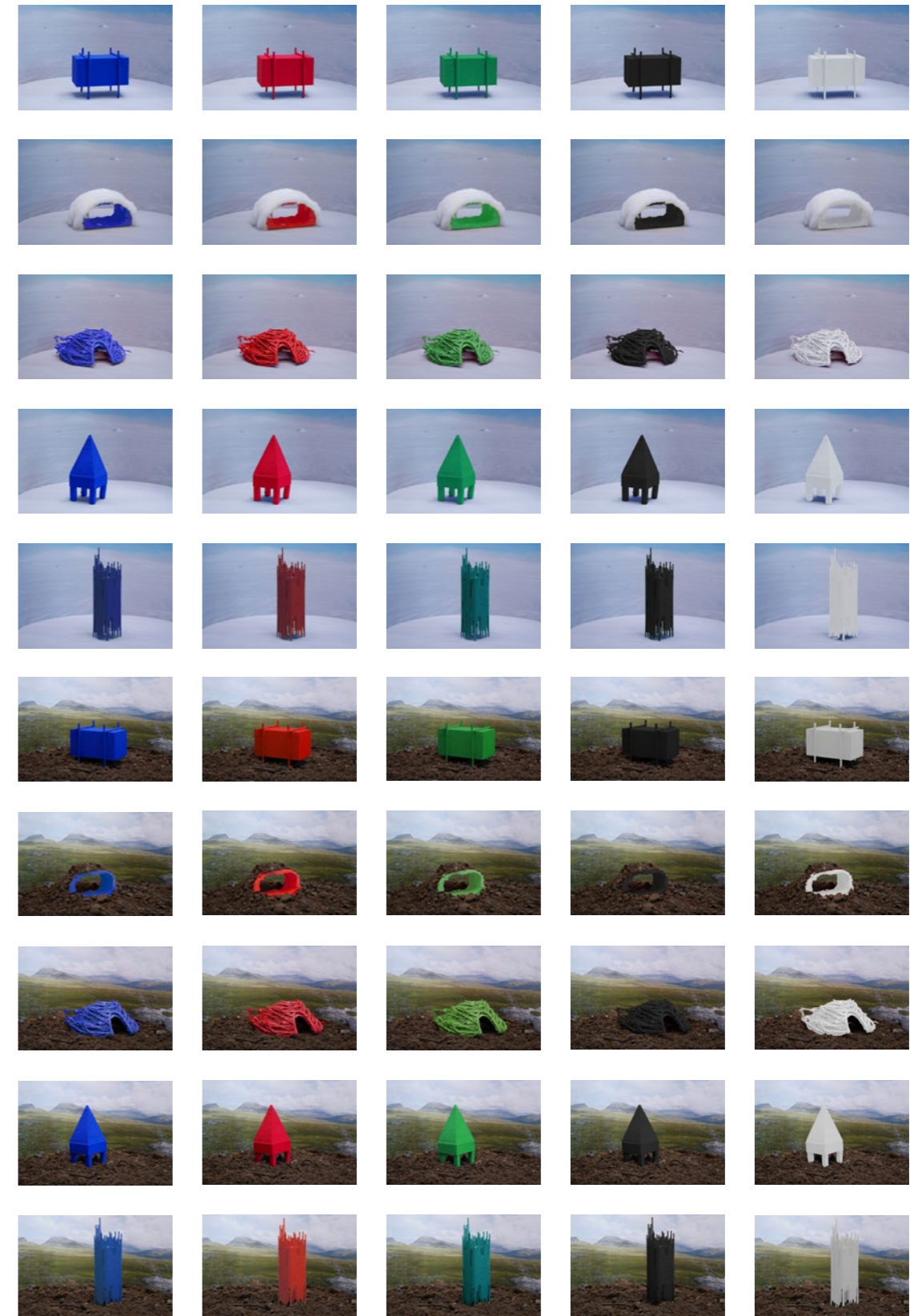

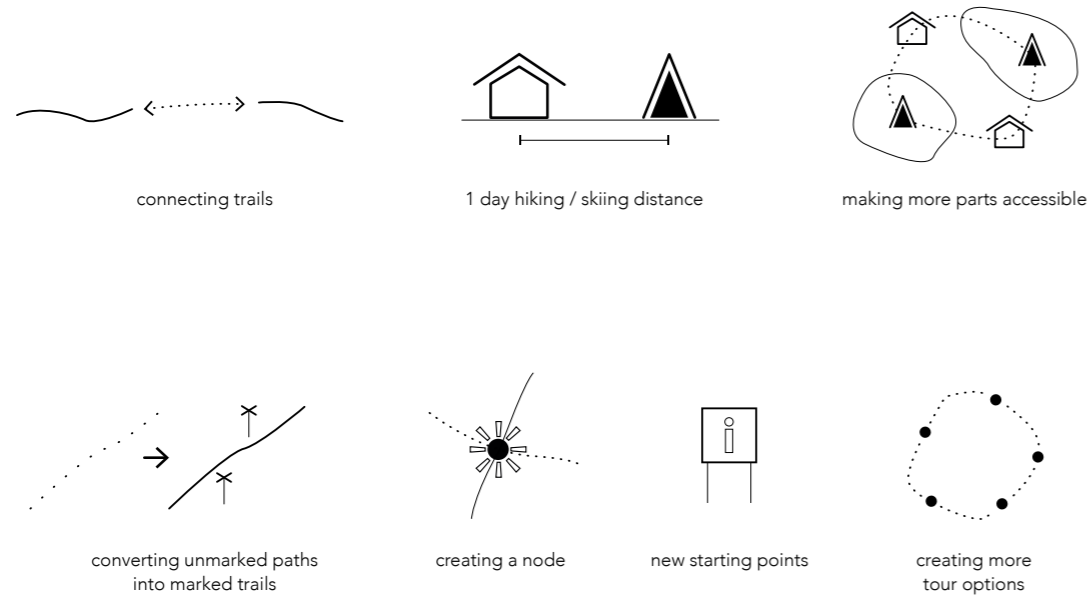

connecting trails

1 day hiking / skiing distance

making more parts accessible

converting unmarked paths into marked trails

creating a node

new starting points

creating more tour options



Typical winter route marker in Sweden

Planning strategies

The overall approach to creating a new trail plan development of the area is to propose better connections across the border and to connect all 9 areas better with each other. To unify the area and make it accessible as a whole territory. Many parts today lack the needed trails or accommodation options for people to get there. For instance, the southern parts of Femundsmarka that are mostly bare mountain terrain, or the eastern parts of Långfjället that holds a vast plain and marsh landscape. In the northern parts it is also possible to create better connections to the other popular hiking areas north of Tänndalen. Since much of the outdoor activities today are centred around western Långfjället, and Grövelsjön in particular, another approach is to decentralize the activity by creating more starting points, a new node in the middle of the site and more longer and shorter route options. Already in the Långfjället maintenance and protection plan from 1992 it is stated that parts of the area are overrun by tourists and that the width of trails have become "highways" and as such perform to much wear and tear on the terrain (Länsstyrelsen Dalarna, 1992).

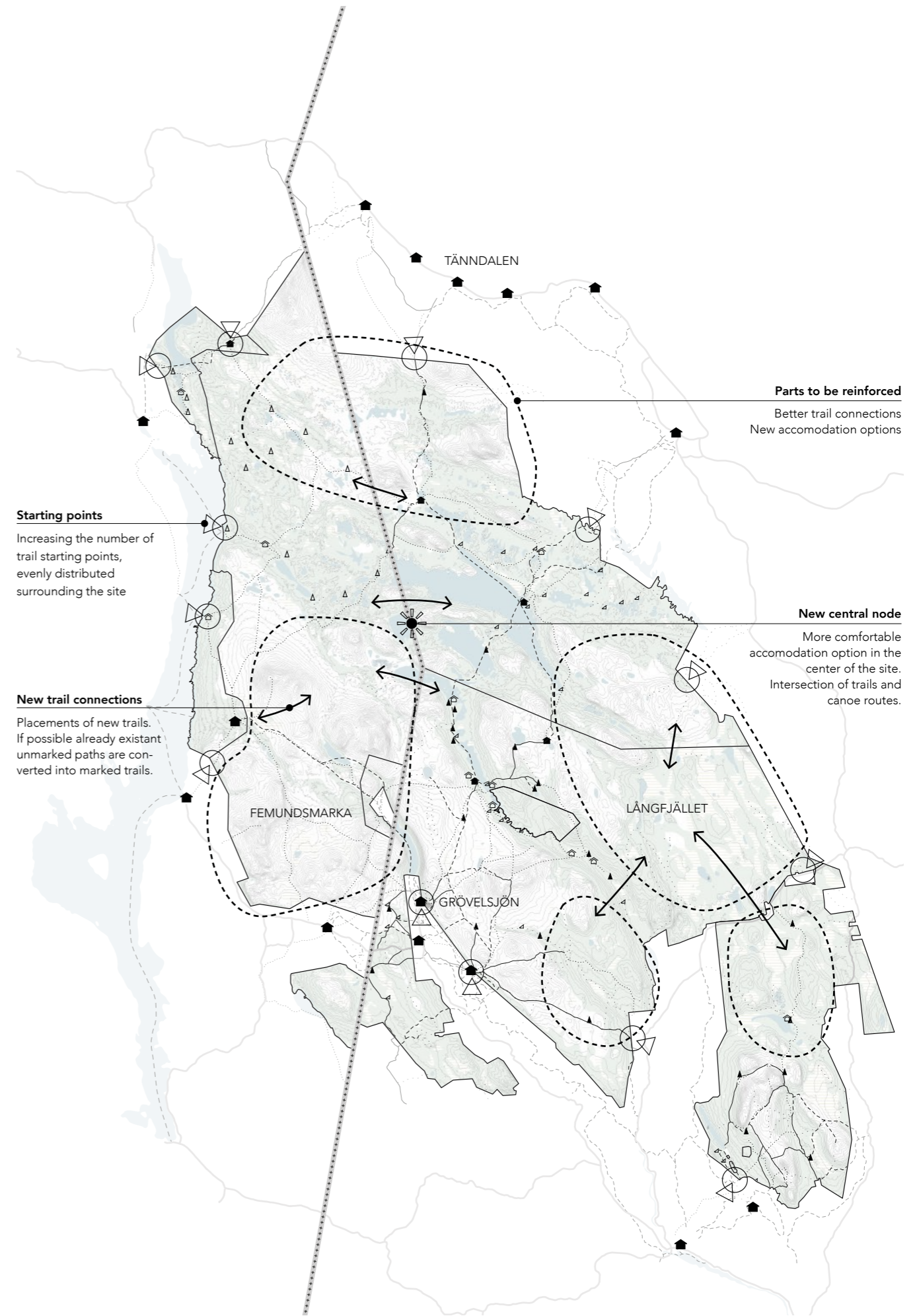

Starting points

Increasing the number of trail starting points, evenly distributed surrounding the site

New trail connections

Placements of new trails. If possible already existant unmarked paths are converted into marked trails.

Parts to be reinforced

Better trail connections
New accomodation options

New central node

More comfortable accomodation option in the center of the site.
Intersection of trails and canoe routes.

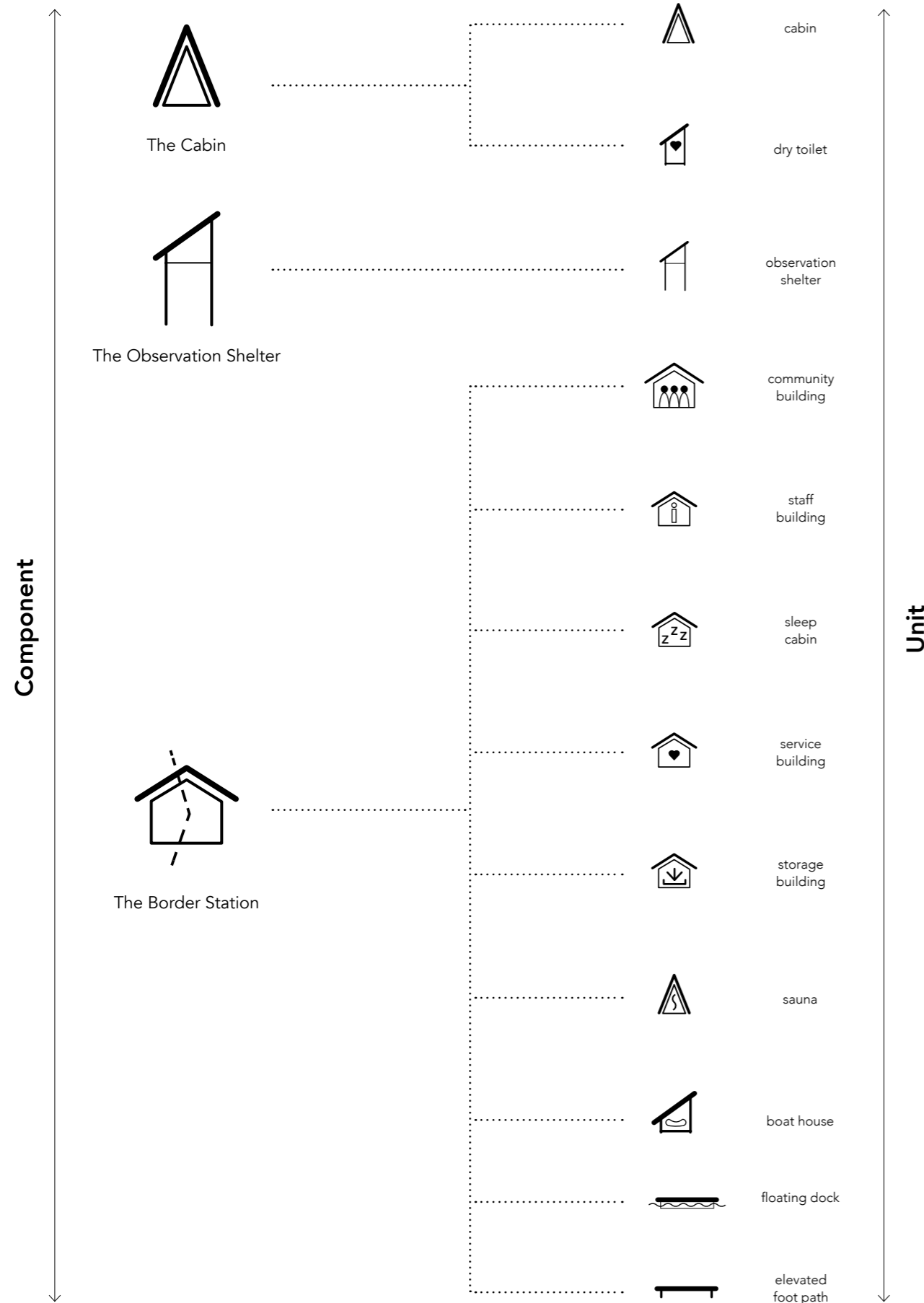

01 - Context

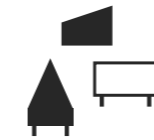

02 - Appearance



03 - Structure



04 - Quantifiable

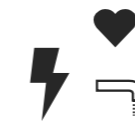















05 - Functions

Defining a design rule book

As a way to create a layer upon layer way of working with the design of the components and their individual units within the system, the important defining features are listed within a defining matrix. It is to serve as the rule book for the design. The features are based on experiences from the site visit, previous impressions from similar experiences, the current design of the available infrastructure on the site and what others have had to say on the topic. For instance, there is an article written in 1963 by Ralph Erskine about building in Nordic nature. In his article Erskine (2008) defines the most important aspects to take into consideration when building in arctic or subarctic regions. He mentions the importance of studying climate and seasonal changes, the huge differences between summer and winter, and to remember this when it comes to a buildings structure. He insists on finding the most extreme weather situation and using this when testing a designs ability to handle the climate. Erskine points out how important it is to listen to experts on insulation and long-lasting solutions, and not to give in to the architects striving for aesthetics before function. Nonetheless he also mentions the human relationship, and that it is for the people we design and build. That the buildings have to be appreciated both in function as in form by the people living or being in a place.

As well as the features categories (context, appearance, structure and quantifiable) the matrix also defines the functions and as such the program for the different units of the system. It is strictly explaining what is needed for which component and unit in order for it to fulfill the basic needs required for it. The border station is the most complex of the components, catering a higher comfort level for the visitors, and therefore has the highest amount of functions to fulfill. Next up is the cabin that has a much lower comfort level than the border station and thus does not need the same functions concerning higher comfort level such as electricity, sauna or staff. The Observation Shelter has the lowest comfort level and serves only three functions. The design matrix is presented on the next two pages.

| feature component | | 1 - CONTEXT RELATION | | | | | 2 - APPEARANCE | | |
|----------------------|---|--|-------------------------|---------------------------|--|---------------------------------------|------------------------------------|--|---------------------------------------|
| | | accessibility | seasonal use | weather resistance | direction | ground placement | shape | color | roof shape |
| THE CABIN |  | foot ski | All year | cold temp. wind snow rain | 4 direction views adapted to location | elevated, on ground, sunken | uniform, straight edges, visible | high visibility in winter | steep > 45°, sloping 5-45° |
| |  | foot ski | All year | cold temp. wind snow rain | 4 directions | elevated | uniform, straight edges, visible | high visibility in winter | steep > 45° |
| |  | foot | All year | wind snow rain | single direction | on ground, sunken | uniform, straight edges | high visibility in winter | sloping 5-45° |
| OBSERVATION SHELTER |  | foot ski | All year, mainly summer | wind snow rain | 4 direction views, 1 main direction | elevated | uniform, landmark, visible | Monochrome, contrasting to the sky | sloping 5-45° |
| THE BORDER STATION |  | foot ski boat (air transport) (snowmobile) | All year | cold temp. wind snow rain | 4 direction views, trail node | elevated, floating, on ground, sunken | scattered, simple, straight edges | monochrome blending in to surroundings | steep > 45°, sloping 5-45°, flat < 5° |
| |  | foot ski | All year | cold temp. wind snow rain | Placed parallel to elevation curves | elevated | simple, straight edges and angles | monochrome blending in to surroundings | flat < 5° |
| |  | foot ski | All year | cold temp. wind snow rain | Placed parallel to elevation curves | elevated | simple, straight edges and angles | monochrome blending in to surroundings | flat < 5° |
| |  | foot | All year | cold temp. wind snow rain | Placed perpendicular to elevation curves | elevated | simple, straight edges and angles | monochrome blending in to surroundings | flat < 5° |
| |  | foot | All year | wind snow rain | Placed parallel to elevation curves | elevated, sunken for dry toilets | simple, straight edges and angles | monochrome blending in to surroundings | flat < 5° |
| |  | foot snowmobile | All year | cold temp. wind snow rain | Placed perpendicular to elevation curves | elevated, on ground for snowmobile | simple, straight edges and angles | monochrome blending in to surroundings | flat < 5° |
| |  | foot | All year | cold temp. wind snow rain | 4 direction views, 1 main direction | elevated | uniform, straight edges, visible | high visibility in winter | steep > 45° |
| |  | foot boat | Summer - Autumn | wind snow rain waves | Facing boat route from lake Rogen | floating on water | uniform, straight edges and angles | monochrome blending in to surroundings | sloping 5-45° |
| |  | foot boat | Summer - Autumn | waves | Connecting shoreline and boat house | floating on water | simple | blending in | no roof |
| |  | foot | All year | snow rain | Connecting buildings | elevated | simple | blending in | no roof |

| 3 - STRUCTURE | | | | 4 - QUANTIFIABLE | | 5 - FUNCTIONS | | | | | | | | | | | | | | | | |
|------------------------------------|---|--------------------------|---------------|------------------|--|---------------|----------|---------|---------|--------|-----------|--------|-----------|-------------|-------|------|-------------|--------------|--------|-------------|---------|--|
| construction | materials | indoor climate | comfort level | availability | number of people | shelter | sleeping | cooking | washing | drying | fireplace | toilet | tap water | electricity | staff | shop | information | social space | access | waste disp. | storage | |
| prefab modules, framework below | IsoTimber, Plywood, Glulam | low - medium temperature | medium | 10-15 | 8-10 / unit | | | | | | | | | | | | | | | | | |
| prefab modules, framework below | IsoTimber 200 mm, Plywood, Glulam | 10-20° C | medium | 1 | 8-10 | | | | | | | | | | | | | | | | | |
| prefab modules | IsoTimber 120 mm, Plywood | outdoor temperature | low | 1 | 1 | | | | | | | | | | | | | | | | | |
| prefab modules, external framework | IsoTimber 200 mm, Plywood, Glulam | outdoor temperature | low | 10-15 | 8 / unit | | | | | | | | | | | | | | | | | |
| prefab modules, external framework | IsoTimber, Facade panels, Plywood, Glulam | low - high temperature | medium - high | 1 | 40-50 | | | | | | | | | | | | | | | | | |
| prefab modules, external framework | IsoTimber 300 mm, Facade panels, Glulam | 20-25° C | medium - high | 1 | 40-50 users, kitchen space for 15 people | | | | | | | | | | | | | | | | | |
| prefab modules, external framework | IsoTimber 300 mm, Facade panels, Glulam | 20-25° C | medium - high | 1 | 2 (staff members) | | | | | | | | | | | | | | | | | |
| prefab modules, external framework | IsoTimber 200 mm, Facade panels, Glulam | 20-25° C | medium - high | 5 | 8-9 / unit | | | | | | | | | | | | | | | | | |
| prefab modules, external framework | IsoTimber 200 mm, Facade panels, Glulam | outdoor temperature | low | 1 | 40-50 users | | | | | | | | | | | | | | | | | |
| prefab modules, external framework | IsoTimber 200 mm, Facade panels, Glulam | 10-20° C | medium | 1 | | | | | | | | | | | | | | | | | | |
| prefab modules, framework below | IsoTimber 200 mm, Plywood, Glulam | 20-100° C | medium | 1 | 10-20 | | | | | | | | | | | | | | | | | |
| prefab modules, external framework | IsoTimber 200 mm, Plywood, Glulam | outdoor temperature | low | 1 | | | | | | | | | | | | | | | | | | |
| prefab modules | wood floatation modules | outdoor temperature | low | 1 | | | | | | | | | | | | | | | | | | |
| prefab modules | wood | outdoor temperature | low | by demand | | | | | | | | | | | | | | | | | | |

Main structure

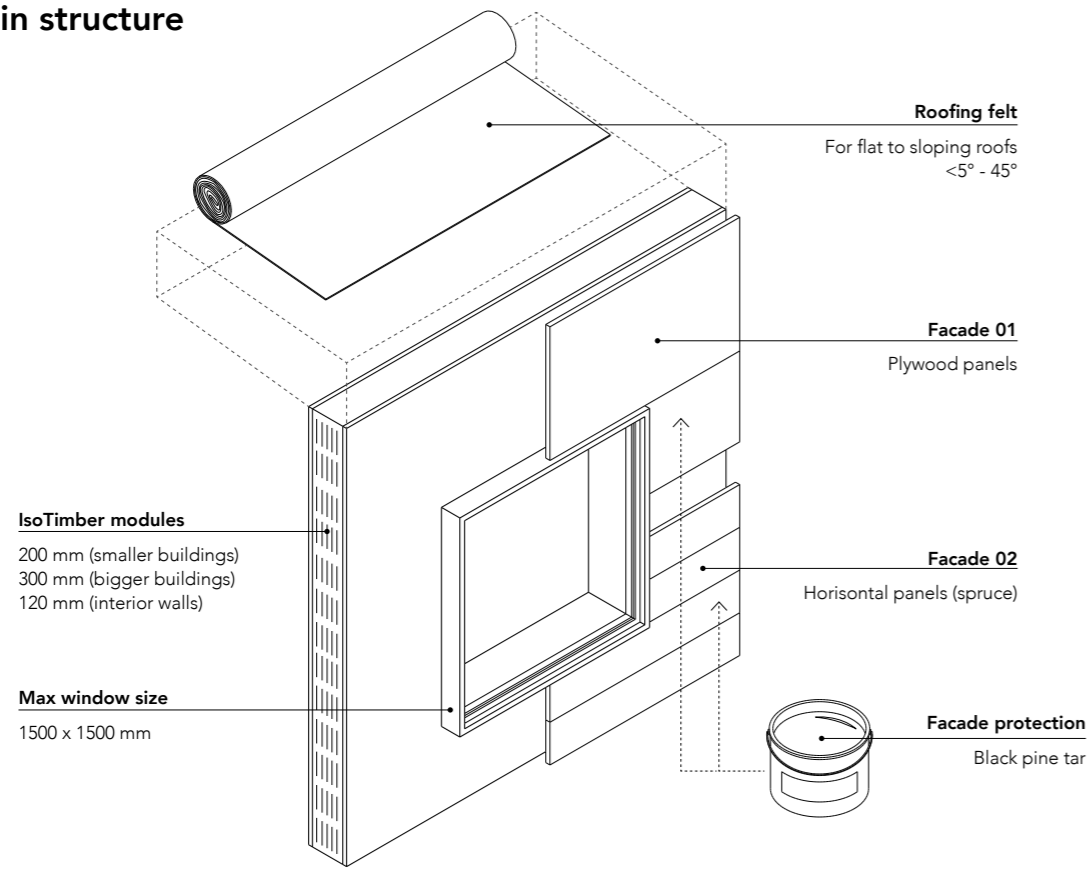

External framework

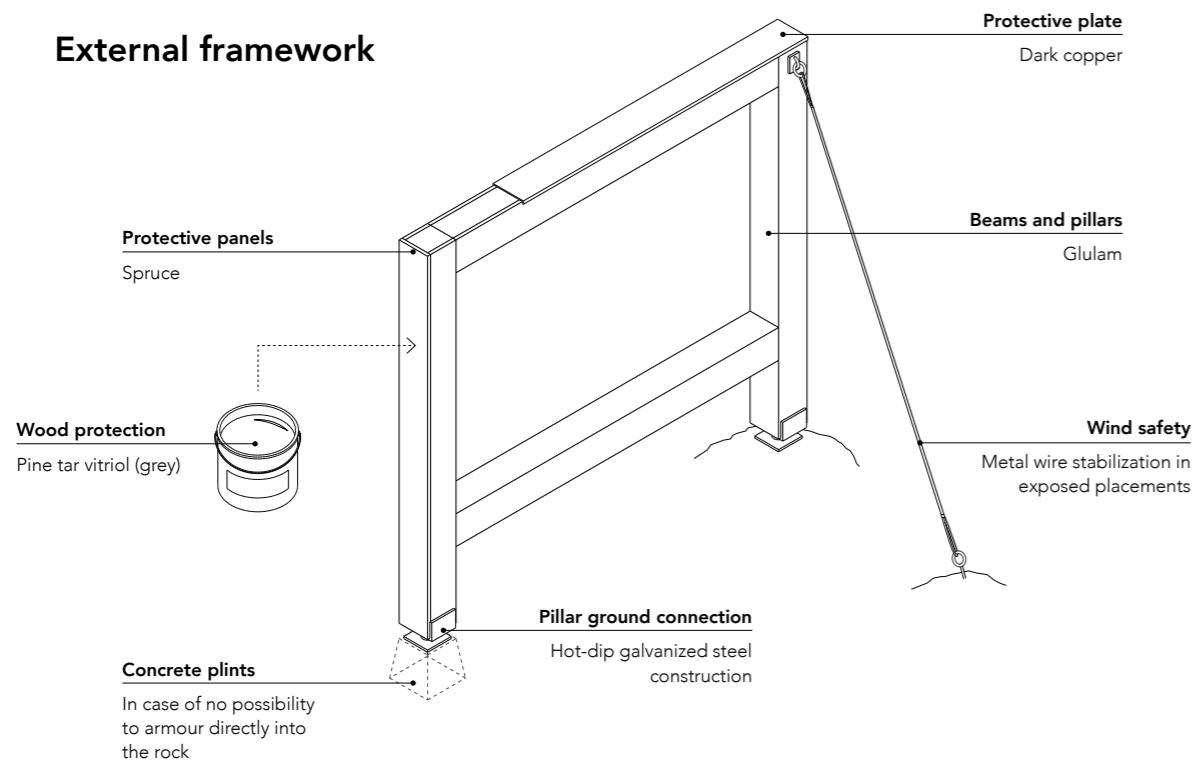

1- Prefabricated modules

Packed into cargo boxes

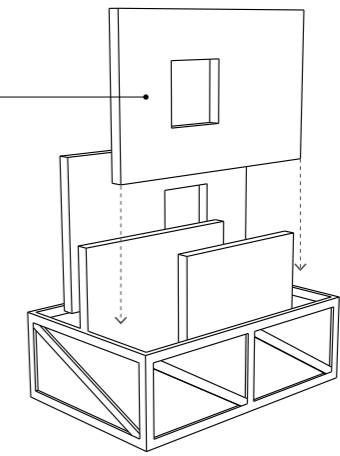

2 - Air transport

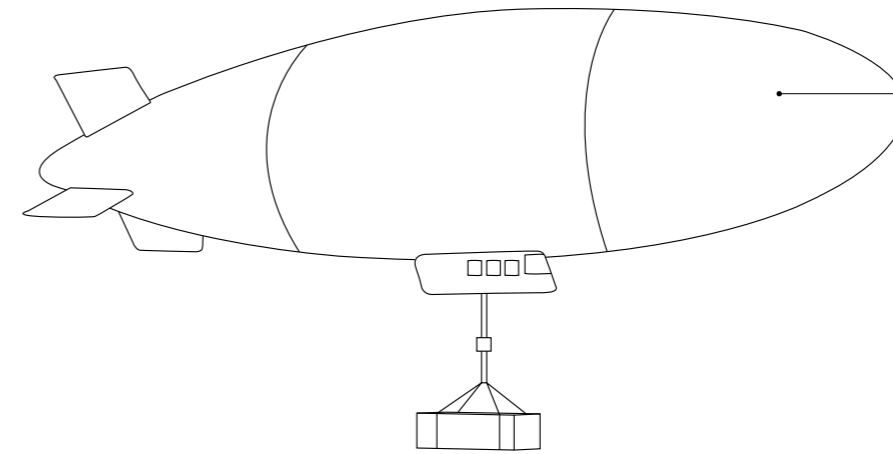

In the near future the use of airships for cargo deliveries to remote places could become a wider used and more sustainable solution to helicopter transport (Piesing, 2019).
An airship in Grönlandet could later be used for making deliveries to the cabins around the area. Having its base at one of the main access points, for instance in Grövelsjön.

3 - Delivery to site

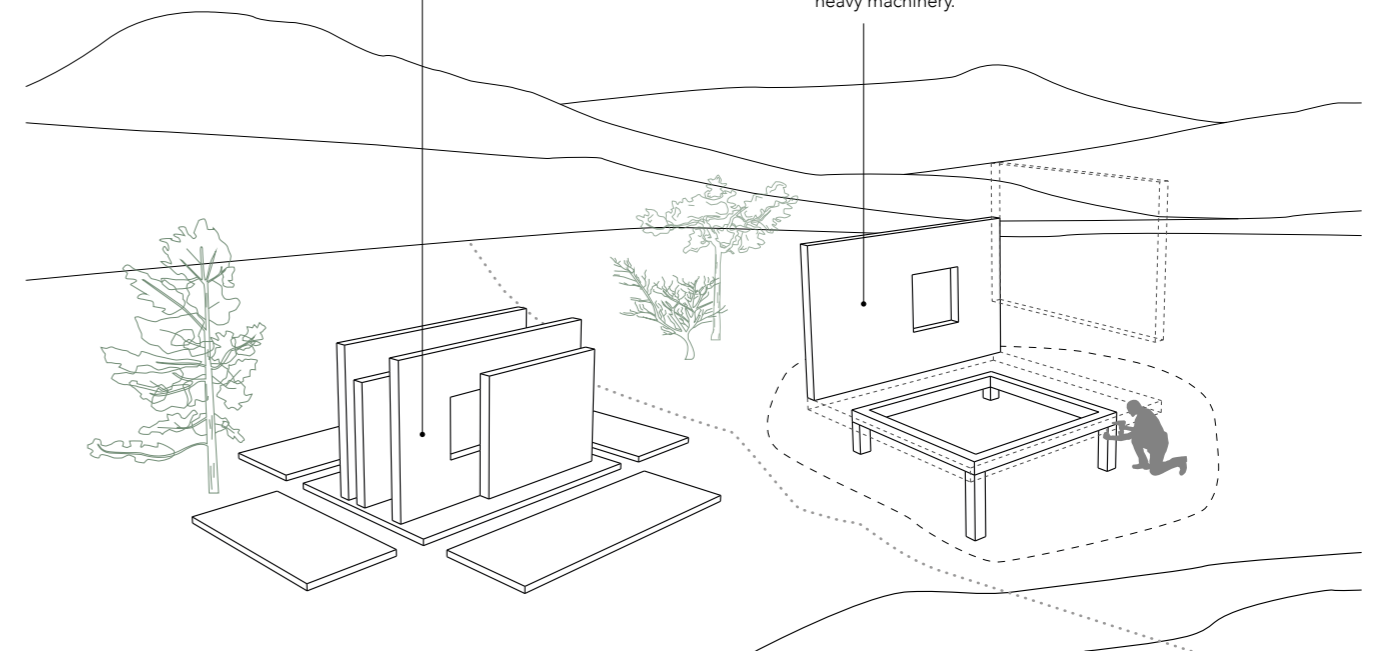

4 - Assembly

Modular construction makes it easy to assemble without the need for heavy machinery.



Figure 4. Norrländsk fåbovall, oil painting (Genberg, 1898)
Reference of how historical buildings fit into the landscape

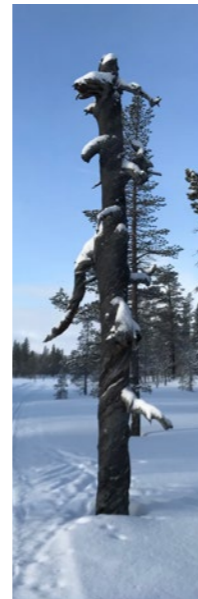

Dead tree trunk,
inspiration to grey
vertical design elements

Formfinding

Each component in the system has a strong connection to the site's cultural and natural history. Design elements and functions from current infrastructure and historical buildings have been used to define a design concept for each building. Sometimes it is a whole shape or structural idea, other times just a small interior feature or defining function that has been used as a reference. Like when John Åkerlund designed some of the first Mountain Stations in Sweden, he always had the visitors experience and a strong relationship to the site as his top priorities (Kindblom, Kindblom & Bergquist, 2002) a similar approach has been taken here. For Åkerlund the sense of community and the importance of cosiness can clearly be seen in his buildings, in the proposal of this thesis community and people gathering around a fireplace is a reoccurring element in all components.



Black pine tar & pine tar vitriol sample

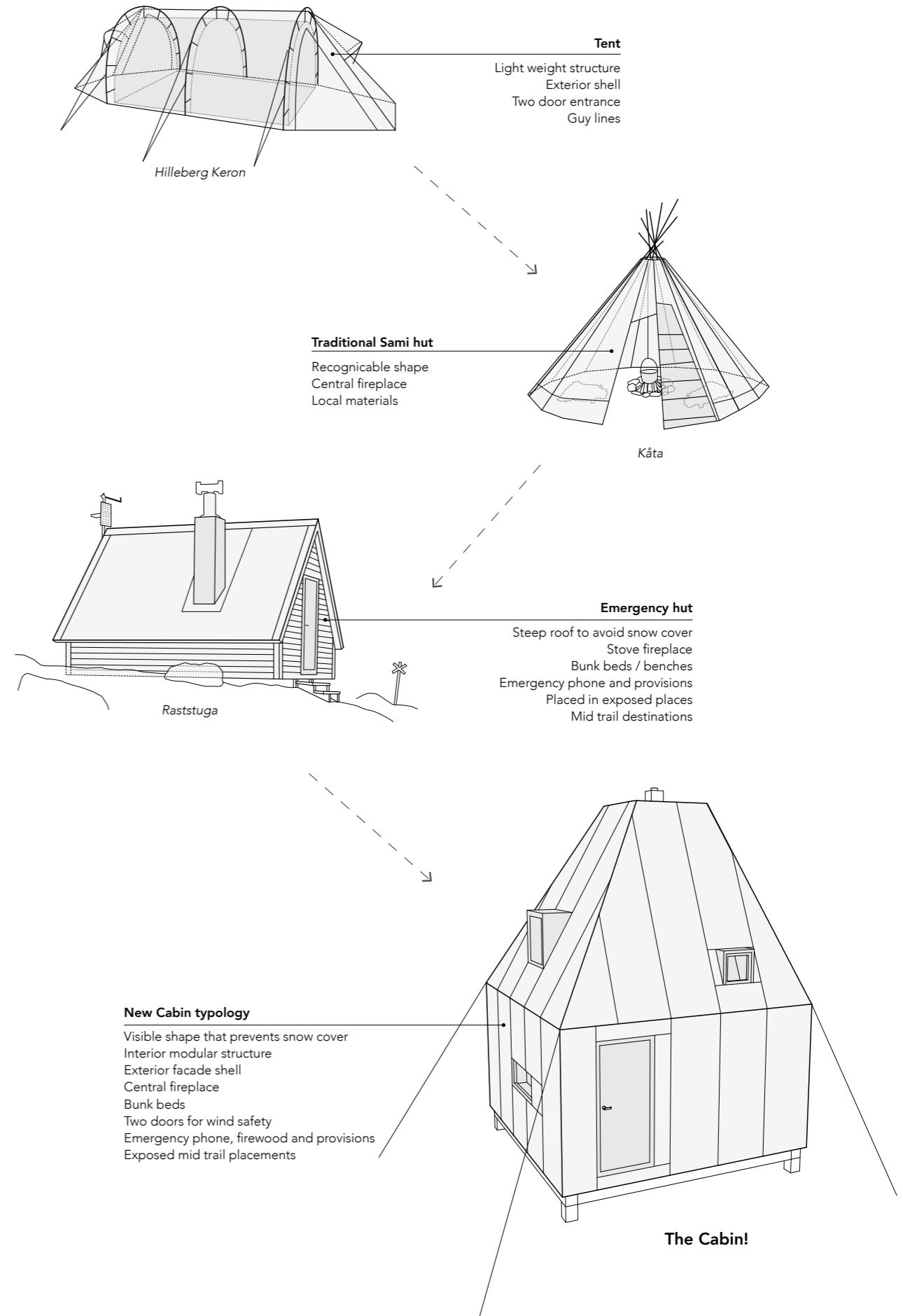

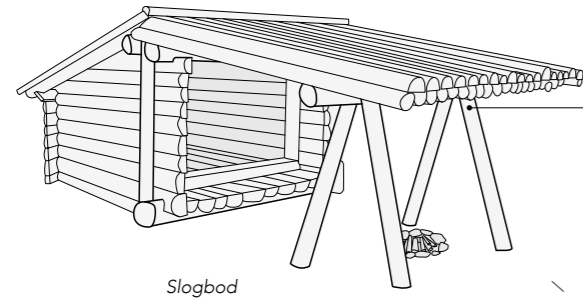

Typical windshelter
 Primitive comfort
 Rigid structure
 Open fireplace
 Meant for shorter breaks

Slogbod

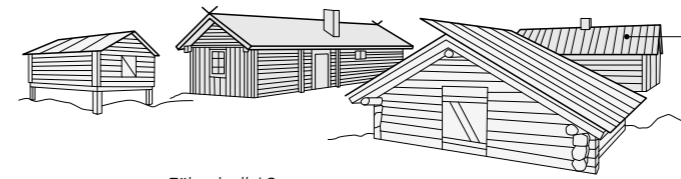

Historical mountain farm
 Cluster of buildings
 Each buildings has its own purpose
 Adapted to terrain and climate

Fäbodvall / Sæter

Observation tower
 Landmark
 Tourist attraction
 View platforms
 Open structure
 Not present on the site today

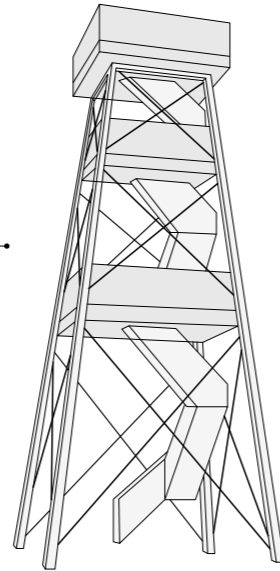

Utsiktstorn

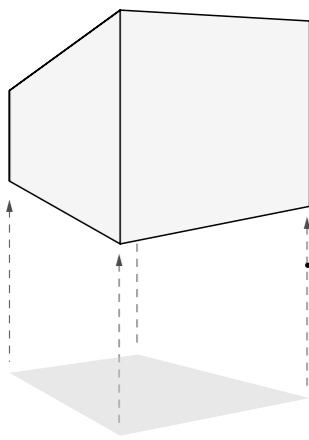

simplified Slogbod shape

Elevating the windshelter
 Creating a new typology
 combining windshelter and
 observation tower

Mountain Station
 High comfort accomodation
 Important trail destination
 Staff

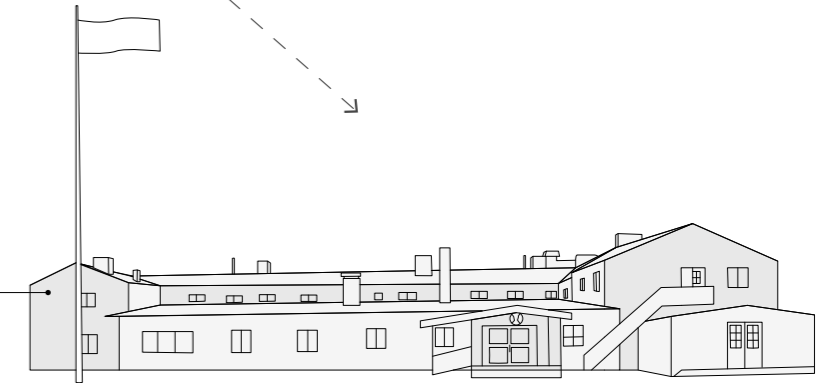

STF Grövelsjön Fjällstation

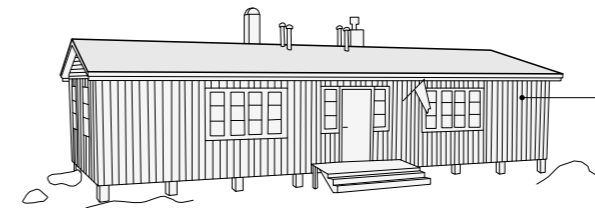

Typical tourist cabin
 Cabin module
 Elevated placement
 Simpler comfort level
 Shared spaces with other tourists
 Staff

Fjällstuga 65 / Abrahamssonstugan

New Shelter/Tower typology
 New landmarks
 Becomes a tourist attraction
 Gives shelter and a view above the canopy
 Meant for shorter breaks
 Open fireplace

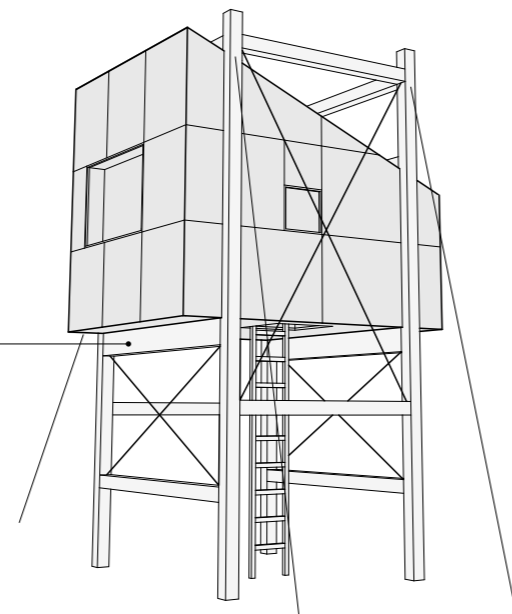

The Observation Shelter!

New accomodation node
 Cluster of buildings divided by function
 Adapted to terrain
 Higher comfort level
 Inbetween option of mountain station and
 tourist cabin

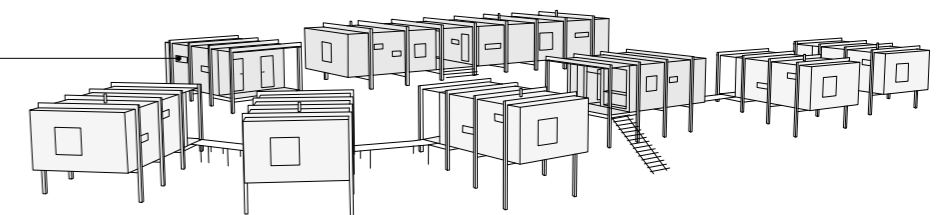

The Border Station!



Proposal

The proposal chapter shows the material that is the main response to the thesis question and aim: A design proposal for a new infrastructure system for ecotourism in *Gränslandet* along with a proposal for trail development and placement of the components. In this chapter the system and its impact on the site is explained on the big 2000 km² scale, through a route scenario showing the system interaction with itself and the already available infrastructure, and all components and their units are explained in detail.



The Border Station
1



The Cabin
13



The Observation Shelter
9

New site plan

This shows a proposal for how the trail network can be expanded by new trail connections that connect the area in more places. Where it was possible unmarked footpaths were converted into marked trails. In other places a completely new trail will have to be marked out. The markings of the trails will continue in the same way as it has been done in the area, and other locations, before by painted marks on rocks and trees for summer trails and red crosses on poles for winter trails. To reinforce the available infrastructure of accommodations the new cabin typology has been placed with one day's hiking or skiing distance between them or another accommodation option. That means the distance from one accommodation to the next ranges between 10 and maximum 20 kilometres, based on the normal pace of 3-4 km/h for hikers and skiers. The Observation Shelters have gotten proposed placements in possibly interesting view spots and on trail intersections that make them good places for shorter daytime breaks. The Border Station is placed in a central location on the Swedish-Norwegian border, connecting three trails and a canoe route.

- Hotel | Hostel | Mountain station
- Tourist Cabin
- Unstaffed Tourist Cabin
- Emergency hut
- Open hut
- Wind shelter
- Contour lines
- Built-up area
- Forest
- Marsh | Bog | Mire
- Lake
- National boundary
- Nature protection boundary
- Marked summer and winter trail
- Marked summer trail
- Marked winter trail
- Marked trail on ice
- Boat route
- Bigger road
- River

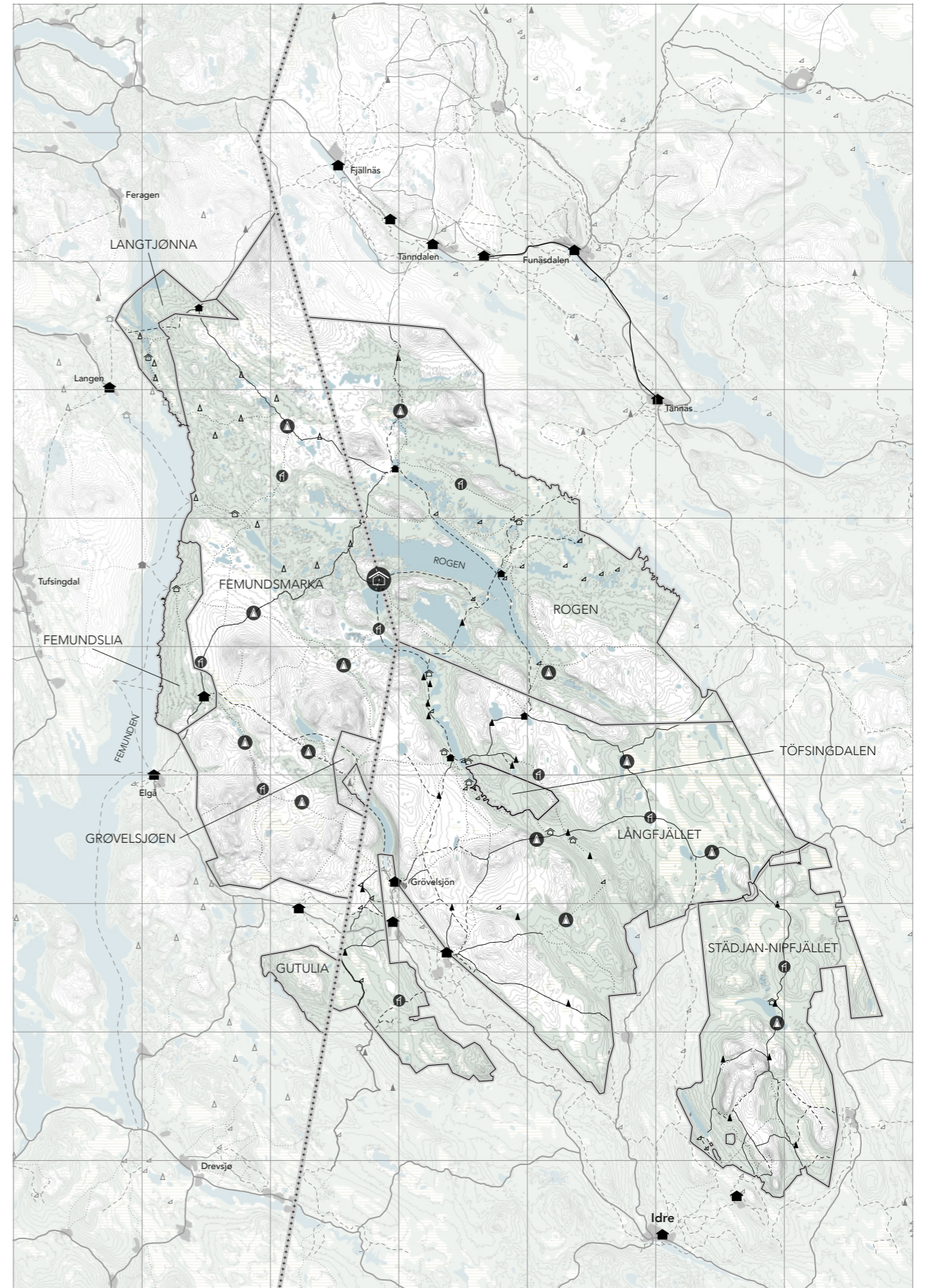

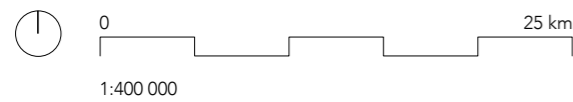
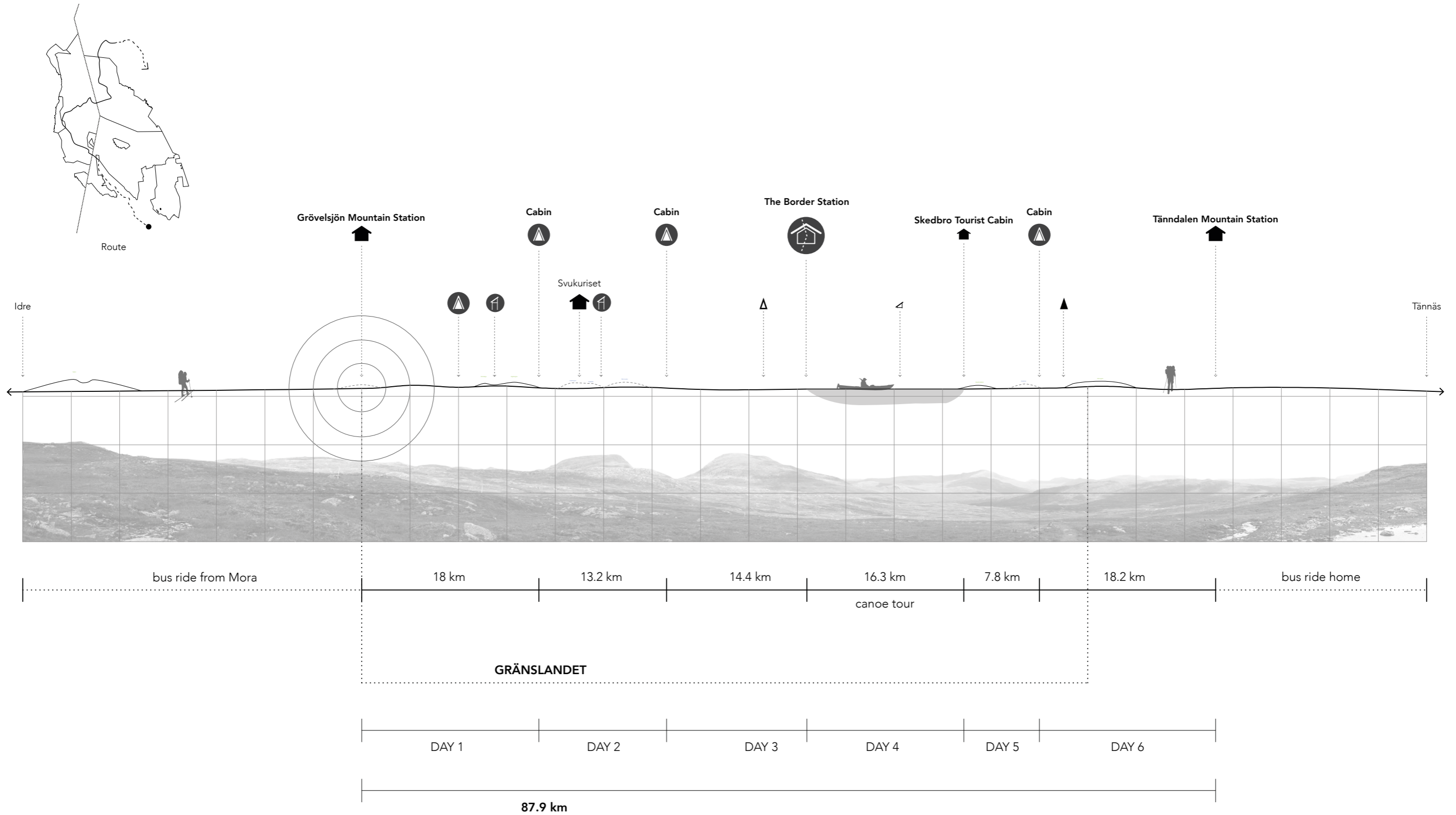

Route proposal showing system interaction

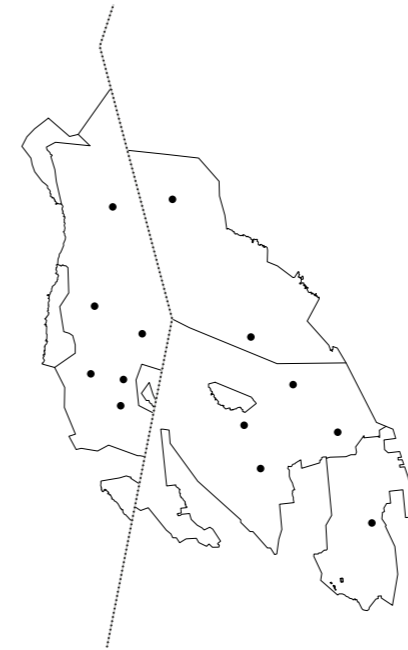

The Cabin

The new cabin typology, placed between the already available accommodation options and along new trails, gives people the possibility to stay in nature for free without having to bring their own tents. They are designed so that they can withstand harsh weather conditions and function in all seasons. They serve an important role in potential emergency situations, being visible from far away and marking the mid-points between the locations of other accommodations.



8 - 10 people



alternative to own tent

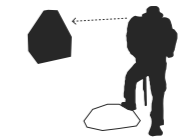

high visibility



closeness to fresh water

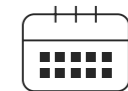

all year round use

Design Matrix Categories

- 01 - Context relation
- 02 - Appearance
- 03 - Structure
- 04 - Quantifiable
- 05 - Functions

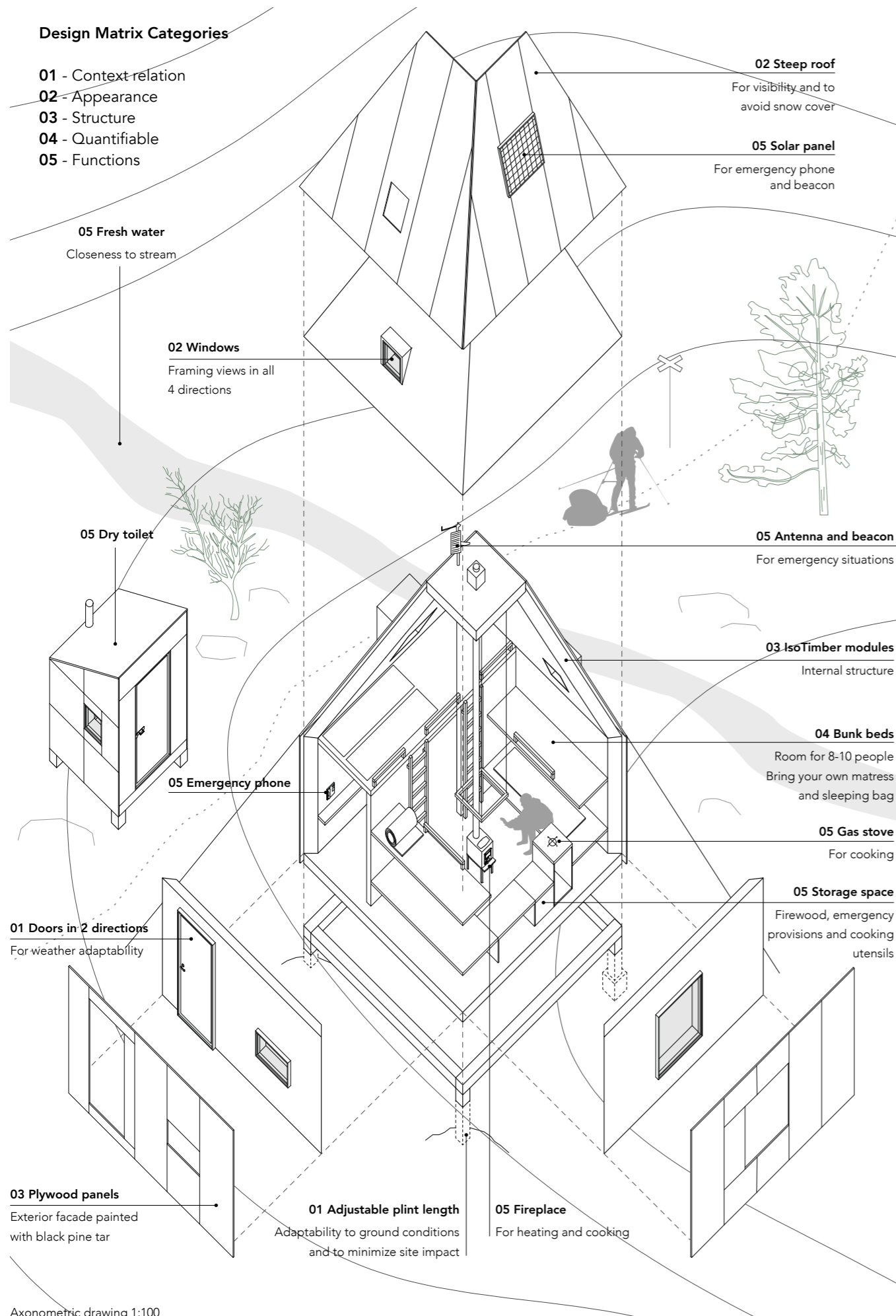

Axonometric drawing 1:100

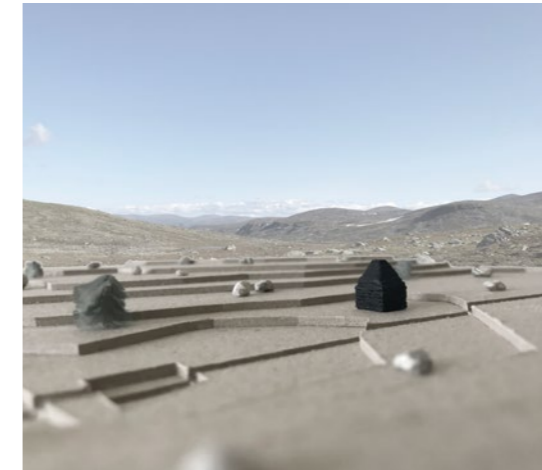

Model of a Cabin in 1:500

The Cabin is placed in 13 locations around the area. Therefore the design of the cabin has to be generic due to its placement in different terrain settings. Doors in two directions make it possible to enter through the one that suits best based on wind and snow conditions. Framed views in four directions make it possible to place the cabin so that the nicest views can be achieved on each location spot. Window placements can also be adapted to each setting. A central heating source is the most beneficial spot for heating up the entire space quickly and keeping it warm. The cabin will be prefabricated in modules that make transportation and assembly at the site easier. Adjustable pedestal length makes it possible to easily adjust to terrain differences and give a minimum impact on the site. Wires from the four corners make it possible to give the cabin extra wind stability. The Cabin holds bunk beds for 8 to 10 people depending on size. Space in the entrance and under the bunks can be used for storing equipment. The height of the cabin makes it visible from far away, the roof shape prevents snow coverage and from the inside it feels lofty and spacious, avoiding a cramped feeling many tents have.

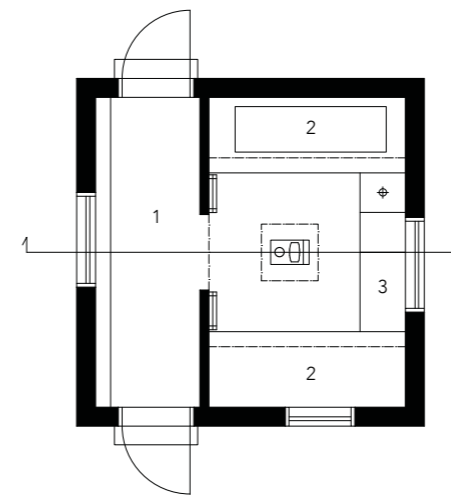

- 1. Entrance
- 2. Bunk beds
- 3. Bench with storage space



Plan 1:100

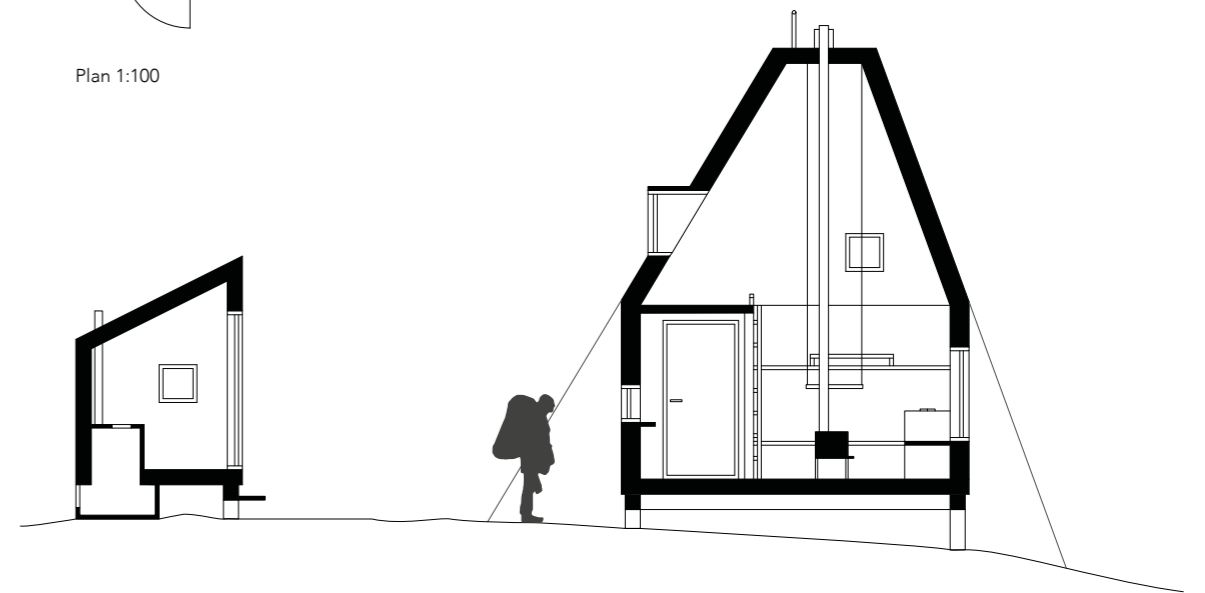

Section 1:100



The Observation Shelter

The elevated wind shelters become a whole new typology in Gränslandet. They are placed in 9 spots of possible great views and at the intersections of trails and midpoints between accommodations. This makes them ideal for shorter mid-day breaks or as destination points for shorter hikes. They work as a new attraction in the territory and provide new ways of looking at the landscape in an elevated spot above the canopy.



max 8 people



landmark

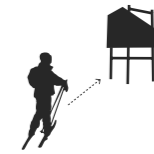

attraction



shorter breaks



view above canopy

Design Matrix Categories

- 01 - Context relation
- 02 - Appearance
- 03 - Structure
- 04 - Quantifiable
- 05 - Functions

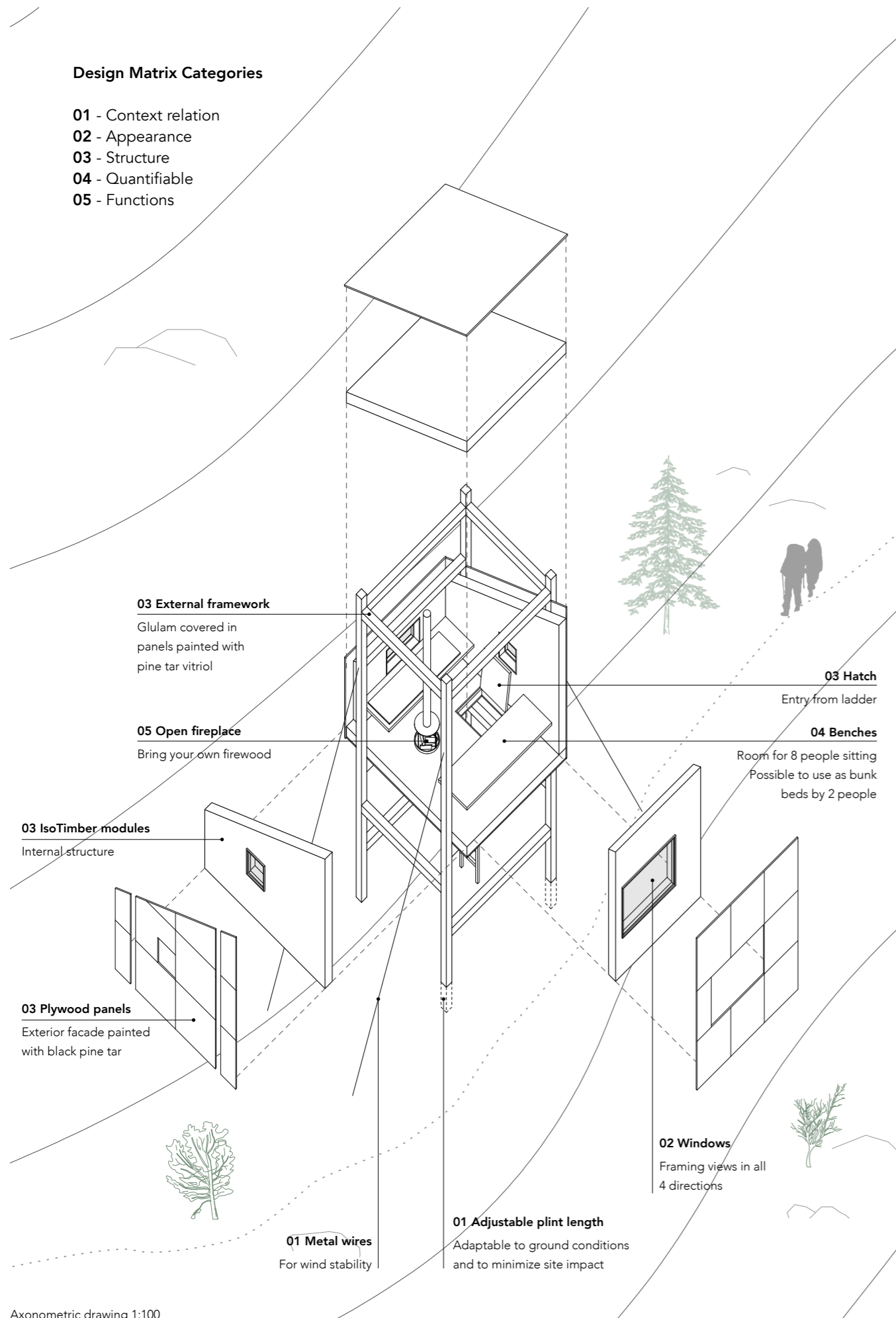

Axonometric drawing 1:100



Model of an Observation Shelter in 1:500

Similar to the already available wind shelters (*Slogbod*) the Observation Shelters serve a similar cause. Up to eight people can sit on the benches together and enjoy a snack in a sheltered space that offers new ways of looking at the landscape. In the middle the shelters have an open fireplace that visitors are free to use if they bring firewood. It can also be possible for two people to stay overnight and use the benches as bunk beds. The Observation Shelters are designed mainly for summer use due to how they are constructed with a climbable entrance and no insulation, but winter use is possible since there is no risk of the shelters snowing in.

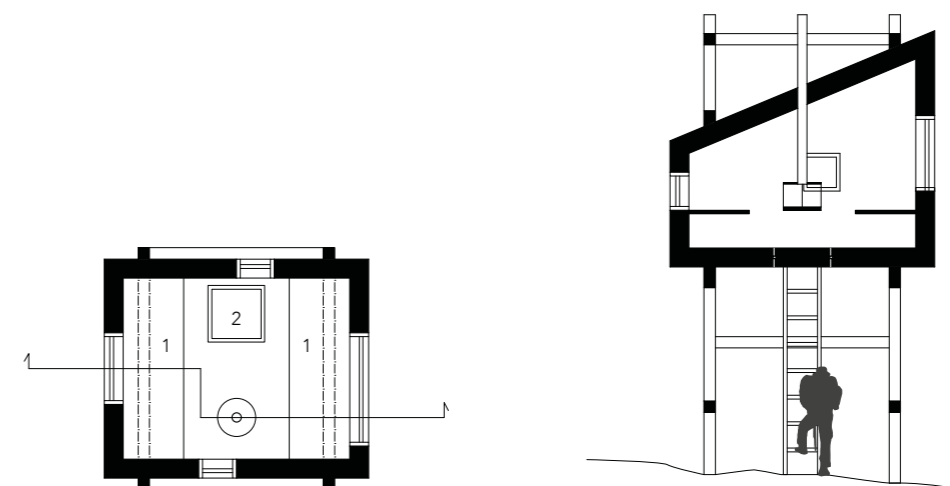

Plan 1:100

Section 1:100

- 1. Benches / bunk beds
- 2. Hatch above ladder



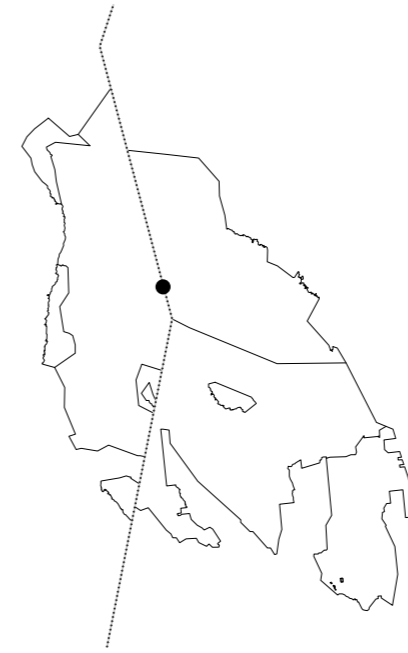

The Border Station

The border station becomes the new node in the centre of the area. It is placed on the border of Sweden and Norway, and the protected areas Femundsmarka and Rogen. It becomes a central destination for hikers, skiers and people travelling by canoe alike. It offers a more comfortable stay than the smaller existing tourist cabins and the new cabins. It has all season staff that handle the distribution of beds, help with repairing equipment, give advice and sell provisions from a small shop.



40-50 people

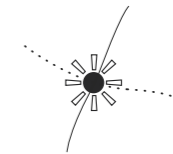

node location



staff

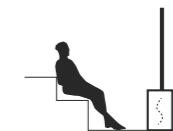

higher comfort



accessibility

Background images in the perspective made of:
 Figure 5. The trail from Skedbro to Rogen have lot of stones (Andreaze, 2017)
 Figure 6. A small lake in Rogens nature reserves (Andreaze, 2017)
 Remixed and reprinted with permission. CC BY-SA

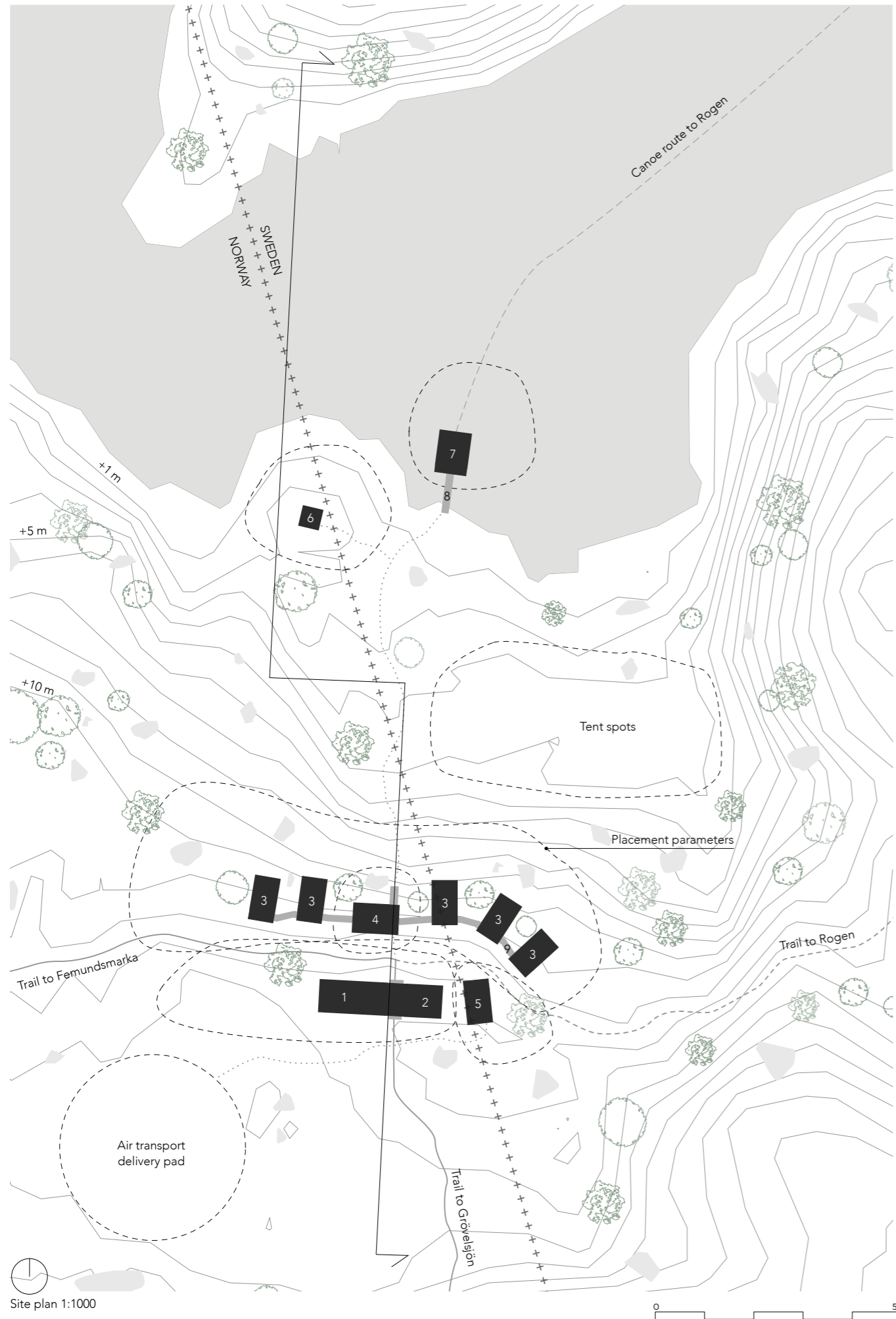

Site plan 1:1000

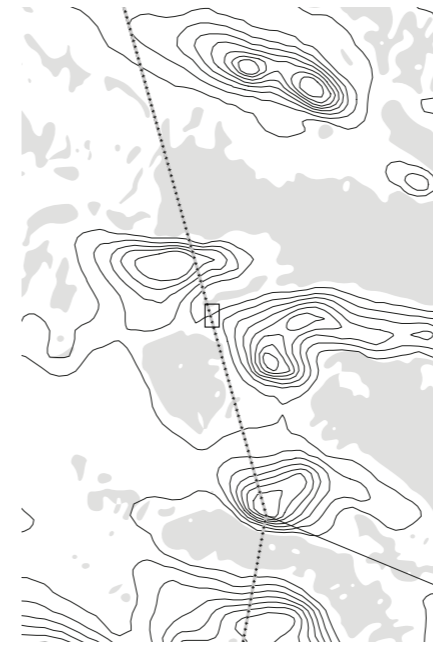

Location



Model of The Border Station in 1:500

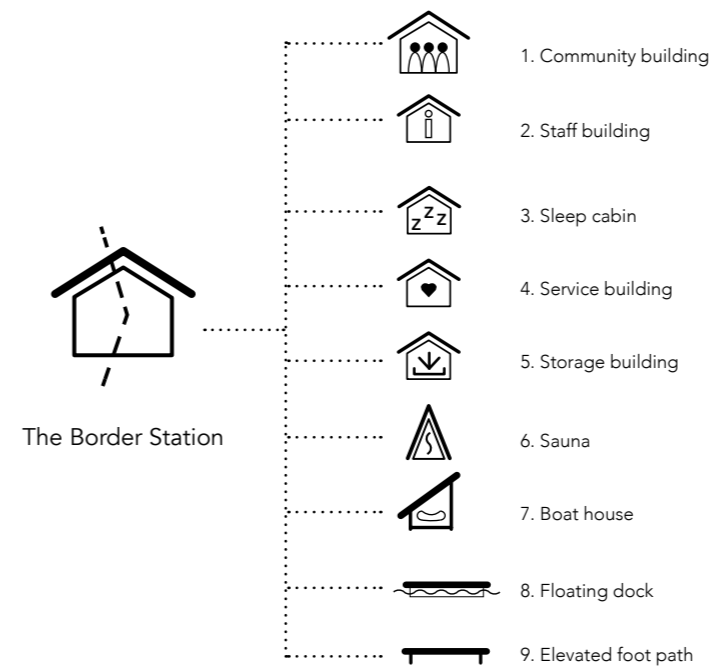

The border station is situated in an intersection of three trails at the tip of a lake connected to the big lake Rogen. This makes the station accessible for hikers, skiers and people coming by canoe. For people who come by boat there is a boat house in the lake where they can leave their canoe overnight and then walk along the floating dock to the shoreline. The site is located in a part of *Gränlandet* that is marked by difficult terrain with many small crooked trees and big boulders scattered on the ground. This performs a challenge when placing buildings in this type of landscape. Therefore, the layout is scattered so as to not appear as one big building and blend in better with the landscape and make placement more adaptable to local conditions. The placements in the site plan show the interaction of the buildings yet each specific placement is only a proposed one. All units are given a parameter in which the individual placement can be adapted based on the ground conditions. The whole structures are elevated and connected by elevated footpaths to have a minimum impact on the site. The layout of the program is based upon functions, user perspectives and views and weather conditions such as wind and sun light.

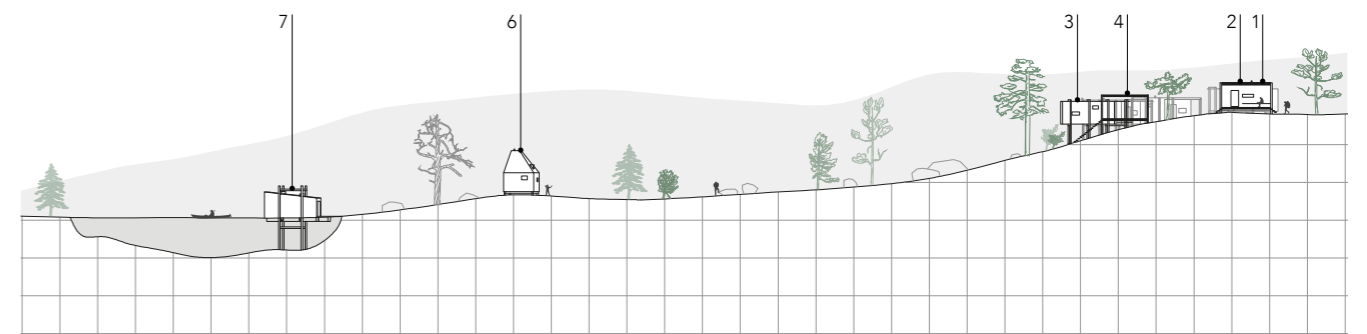

Site section 1:1000

Design Matrix Categories

- 01 - Context relation
- 02 - Appearance
- 03 - Structure
- 04 - Quantifiable
- 05 - Functions

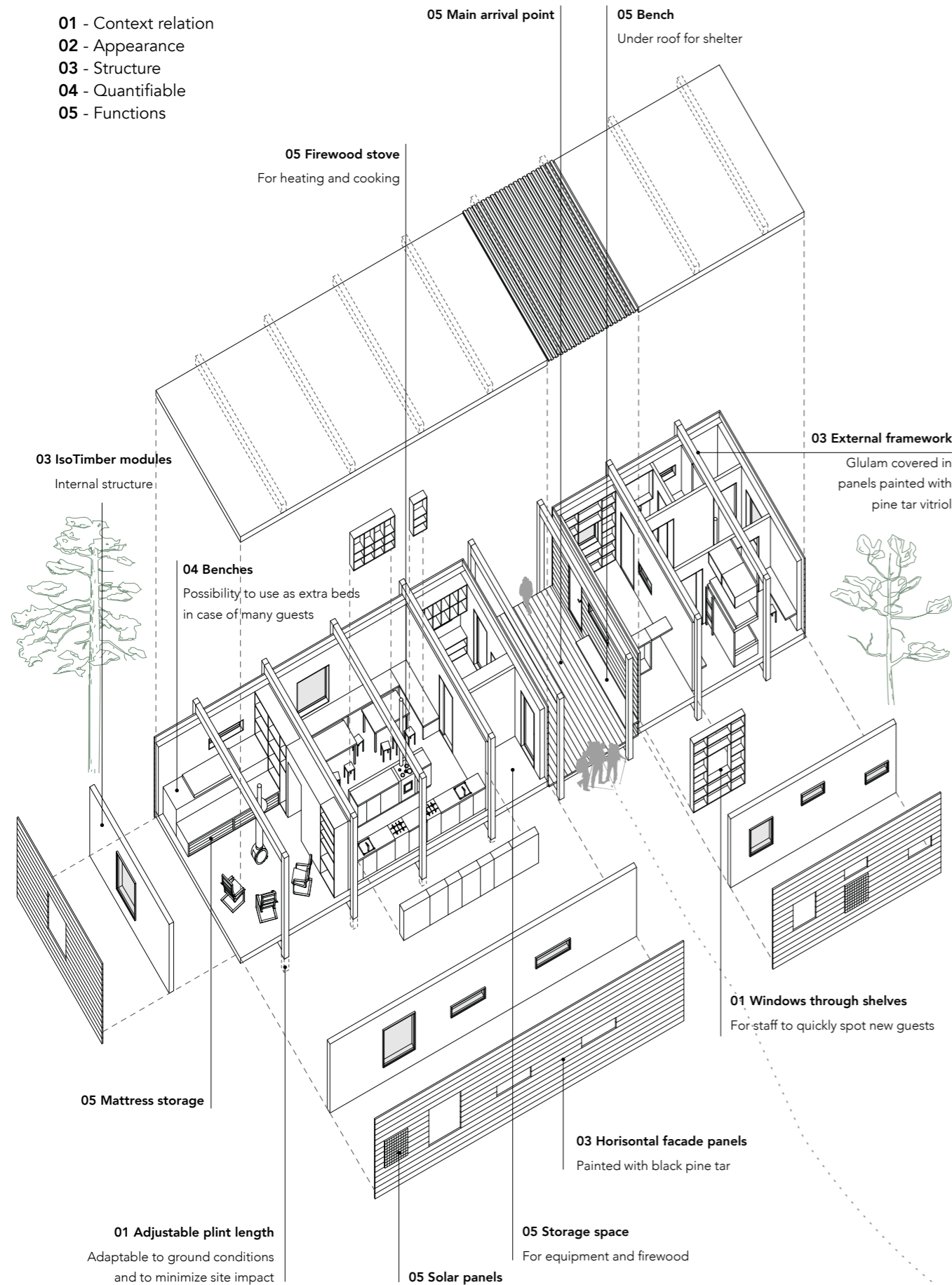

Axonometric drawing 1:200

Community, service and storage building

The community building and the staff building are connected by a wooden deck. This deck becomes the main arrival point to The Border Station. From the deck the visitors get a good overview of the whole site. The two staff members greet the guests in the combined reception and shop area connected to their private housing unit. On the other side of the deck lies the entrance to the community building that holds a shared kitchen for up to 15 people. The kitchen is equipped with two gas stoves and one firewood stove.

Both the community building and the staff building get tap water from a nearby stream and electricity through solar panels placed on the roof and facade. The benches in the living room of the community building can be used as extra sleeping spaces in case of many guests. The service building connects to the sleeping cabins by elevated footpaths. It holds dry toilets, two cold showers, a washing up station and waste disposal. The storage building has a small garage space for a snowmobile, a workshop and firewood storage.

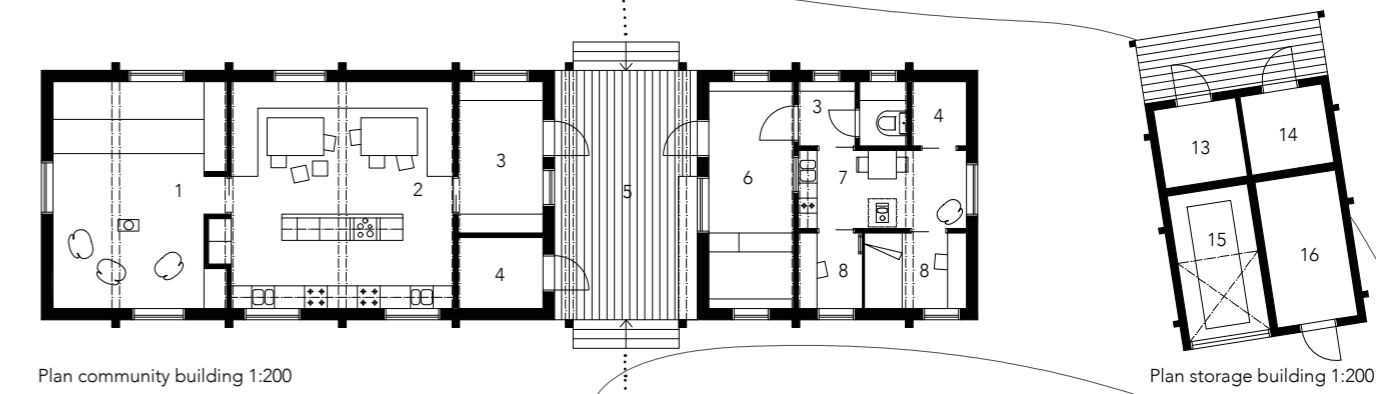
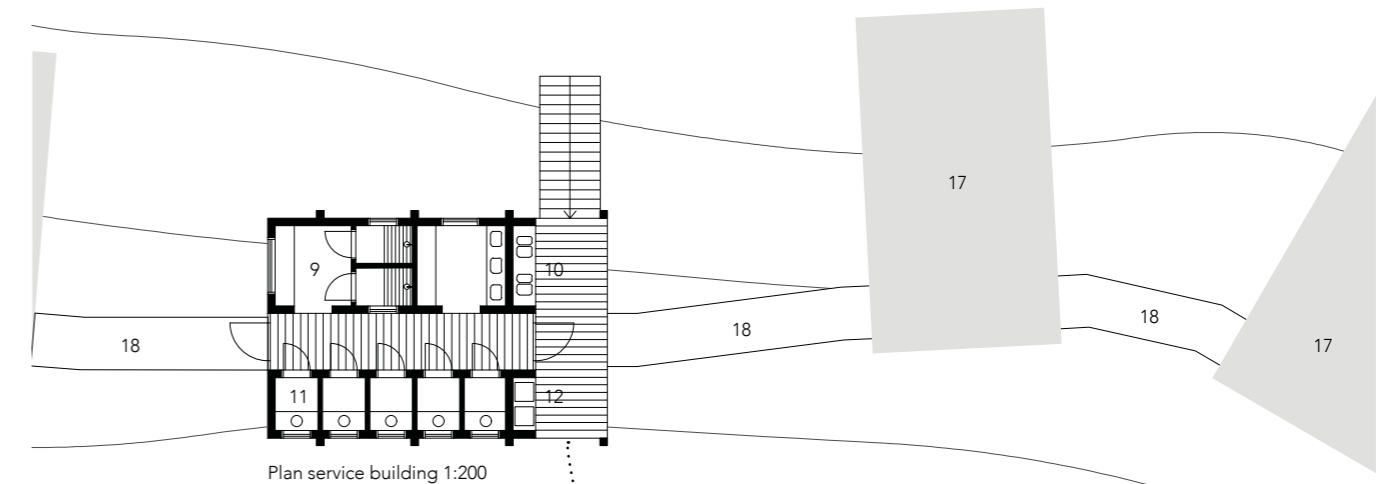

- 1. Shared living room
- 2. Shared kitchen
- 3. Entrance
- 4. Storage
- 5. Wooden deck
- 6. Reception and shop
- 7. Staff housing
- 8. Staff private rooms
- 9. Cold showers
- 10. Water taps
- 11. Dry toilets
- 12. Waste disposal
- 13. Firewood storage
- 14. Workshop
- 15. Snow mobile
- 16. Storage
- 17. Sleeping cabin
- 18. Elevated walkway



Design Matrix Categories

- 01 - Context relation
- 02 - Appearance
- 03 - Structure
- 04 - Quantifiable
- 05 - Functions

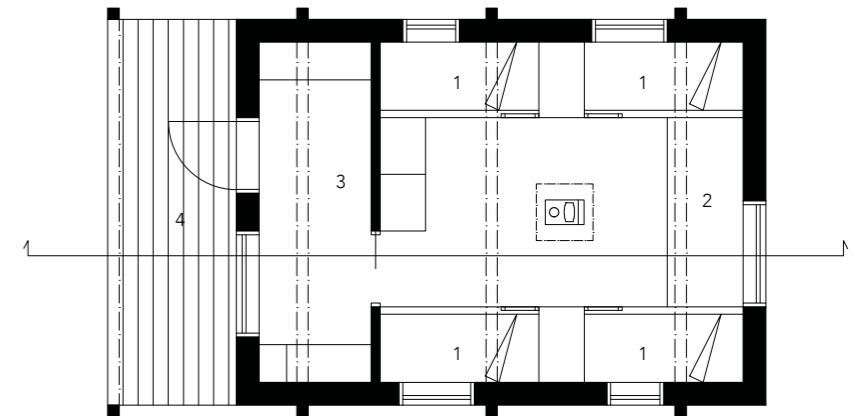
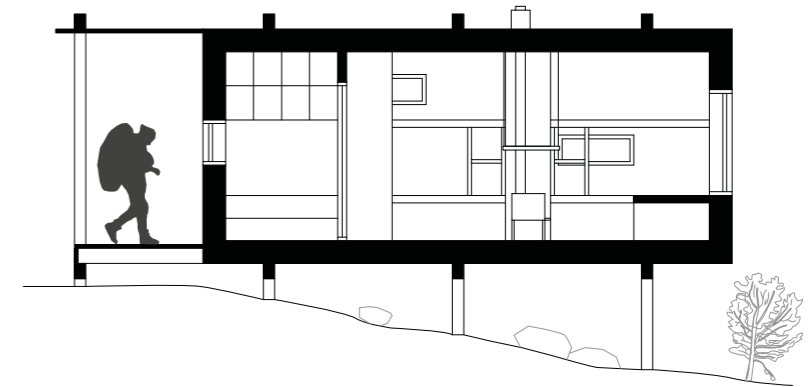
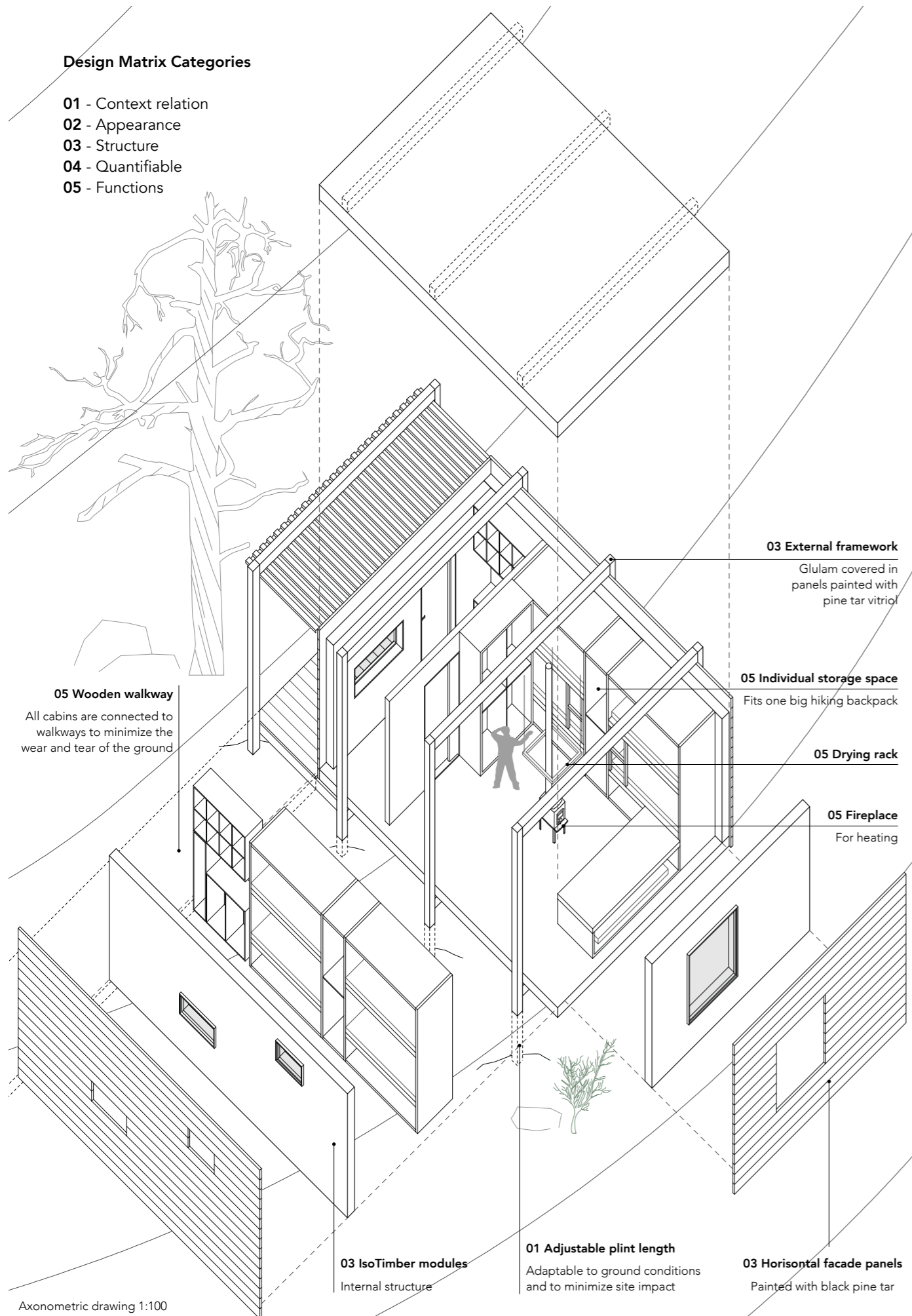

- 1. Bunk beds
- 2. Bench that can be used as an extra bunk
- 3. Entrance
- 4. Wooden deck

Plan 1:100



Sleeping cabin

The Border Station has five sleeping cabins that each can house 8 people. A bench can be made into an extra bed so that each cabin can hold 9 people in times of high occupancy. The sleeping cabins are shared spaces where each guest is given their own bunk fully equipped with mattress, pillow and blanket. A fireplace works as the central heating source for each cabin. It can also be used for drying wet clothes or cooking food in the cabin. All cabins have windows in four directions to make use of as much natural light as possible, as well as solar panels for electric light during darker hours. The entrance space to each cabin is relatively big to fit everyone's equipment. There are also individual storage spaces connected to each bunk bed. Each cabin has a big wooden deck with a protective roof in front of the entrance, the deck leads to an elevated footpath connected to the service building. The cabins are placed perpendicular to the elevation curves to minimize site impact and make it easier to place them due to the challenging ground conditions.

Design Matrix Categories

- 01 - Context relation
- 02 - Appearance
- 03 - Structure
- 04 - Quantifiable
- 05 - Functions

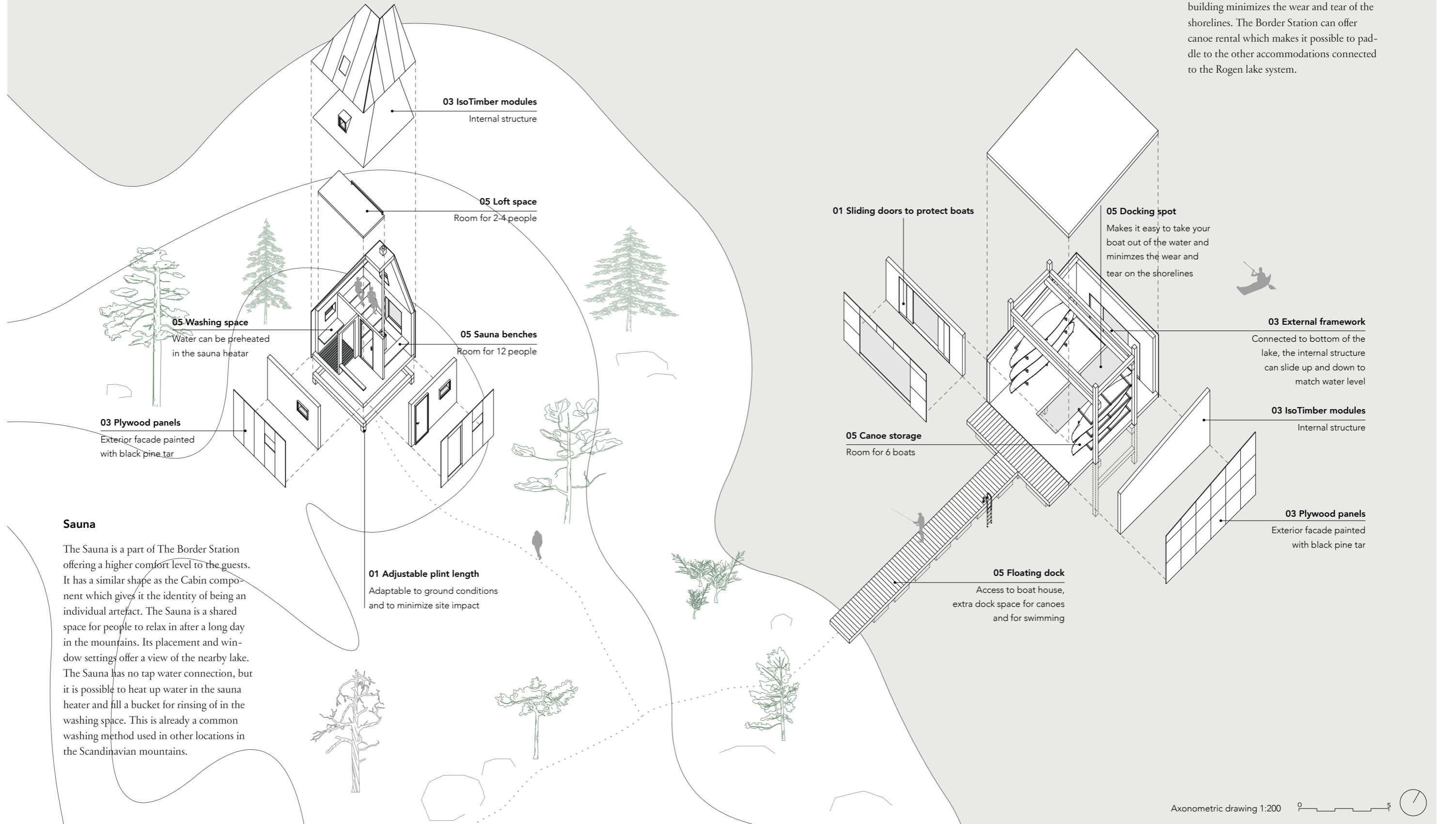

Boat house

The Boat House is the main arrival point for people coming by canoe. It is a safe place to leave the canoes protected from the weather, as well as the docking station inside the building minimizes the wear and tear of the shorelines. The Border Station can offer canoe rental which makes it possible to paddle to the other accommodations connected to the Rogen lake system.

Sauna

The Sauna is a part of The Border Station offering a higher comfort level to the guests. It has a similar shape as the Cabin component which gives it the identity of being an individual artefact. The Sauna is a shared space for people to relax in after a long day in the mountains. Its placement and window settings offer a view of the nearby lake. The Sauna has no tap water connection, but it is possible to heat up water in the sauna heater and fill a bucket for rinsing of in the washing space. This is already a common washing method used in other locations in the Scandinavian mountains.



Background image in the perspective:
Figure 7. Stones and old trees in Rogens nature reserves (Andreaze, 2017)
Remixed and reprinted with permission. CC BY-SA

“How can a system of architectural installations in nature create a sense of identity for the chosen territory and make it more accessible for nature tourism?”

Conclusion

I would say that the most important focus points during this thesis have been centred around identity. Specifically the identity of a place in nature, but also of whole countries and their society. As well as the identity of architecture in certain places. Most of the analytical research regarding the context was made with the intention of capturing just this. What is the DNA? What are the main foundation layers of this place? In my thesis question I wanted to know how to create identity. But during the process this more and more evolved into how to use the identified DNA of the place as a way to strengthen the image of *Gränslandet* rather than creating something completely new. I think this change came due to my initial preconception of the place as being so vast and disconnected that it lacked a unifying identity. The more research I did, the more I discovered that this was not fully true. It had a common history of reindeer herding, cattle farming and of course a whole landscape so strongly marked by the ice age that it looks like no other place in the Scandinavian Mountains. What the site lacked was rather a unifying trail and accommodation network, crossing over the nation border, that would make the place more accessible and by this give it the perception of being one big territory. An issue I think I solved in a holistic way by adding a system of infrastructure where all components are architectural mates, with recognizable features. The system enhances the already present identity of *Gränslandet* rather than trying to add something completely new that ties it together.

Since some critical voices in the initial phase of this project questioned whether I really should propose building on the whole site and not just smaller parts, I will try to answer this question now based on the proposal of the thesis. I say that having this holistic approach and working with the whole 2000 km² site rather than just a smaller part of it minimizes the impact in total if the goal either way is to enhance the whole area sooner or later. It is better to have an overall approach and make good choices while keeping the bigger picture. This will make the overall impact gentler in relation to wildlife and terrain.

Finally, the proposal does change the area within its own parameters to make *Gränslandet* more accessible for tourism. Yet the question of how the tourists arrive to the site remains. Today the Swedish parts can only be accessed by bus. The northern parts of the site are reinforced with more trails and accommodation options, this might mean that more people might choose a starting point in one of the Swedish villages north of the site and not everything will be centred around Grövelsjön. But for many it might still be a hustle to first take a train ride and then a bus to get to their hiking location. The process of making *Gränslandet* into one of the more popular ecotourism spots in central Scandinavia also depends upon the extension of public transport. But adding a new system of tourism infrastructure that strengthens the image of **Gränslandet**, and acts as a steppingstone for people into nature, definitely is a step in the right direction.

Books

Caldenby, C. (2013). Slash architecture. In T. Lauri, (Eds.) *Sveriges Naturum* (pp. 15-25). Arkitektur Förlag.

Erskine, R. (2008). The Challenge of the High Latitudes. In *Nordic Architects Write: A documentary anthology* (pp 361-371). Abingdon: Routledge.

Gössling, S. & Hultman J. (Eds.). (2006). *Ecotourism in Scandinavia: Lessons in Theory and Practice, Volume 4 in the 'Ecotourism' series*. Retrieved from <https://ebookcentral.proquest.com/lib/chalmers/detail.action?docID=289698>

Hammarström, T. (2001). Fjällen. In T. Hagman, T. Hammarström & P. Wästberg (Eds.) *Sverige: Ljus och landskap* (pp. 125-136). Stockholm: Bokförlaget Max Ström.

Isitt, M. (2013). Pathway to nature. In T. Lauri, (Eds.) *Sveriges Naturum* (pp. 7-13). Arkitektur Förlag.

Key, E. (1913). *Skönhet för alla*. Albert Bonniers Förlag: Stockholm.

Kindblom, J., Kindblom, M. & Bergquist, M. (Eds.). (2002). *Bygga och bo: En resa genom 1900-talets svenska arkitektur*. Stockholm: Svenska Turistföreningen.

Løken, S. L., Dyrerud, T. A., Neste, J. (Eds.). (2016). *Nasjonale turistveger*. Oslo: Forlaget Press.

Vowels, K. (2017). *Stuglandet: En guide till fria övernattningar*. Karlstad: Votum & Gullers Förlag.

Reports

Länsstyrelsen Dalarna. (1994). *Skötselplan för Stådan-Nipfjällets naturreservat, Älvdalens kommun*. Retrieved from <https://www.lansstyrelsen.se/download/18.2e0f9f621636c844027f204/1527517515341/St%C3%A4dan-beslut-sktsel.pdf>

Länsstyrelsen Dalarna. (1992). *Skötselplan naturreservat Långfjället*. Retrieved from <https://www.lansstyrelsen.se/download/18.2e0f9f621636c844027da4c/1527511522664/L%C3%A5ngfj%C3%A4llet-beslut-sktsel.pdf>

Länsstyrelsen Jämtlands län. (1993). *Skötselplan Rogens naturreservat, Härjedalens kommun, Jämtlands län*. Retrieved from <https://www.lansstyrelsen.se/jamtland/besoksmal/naturreservat/rogen.html>

Tillväxtverket. (2018). *Svenskars resande: en jämförande studie*. (Rapport 0248). Tillväxtverket. Retrieved from <https://tillvaxtverket.se/download/18.785d4323162a8b507205836/1523273803420/Svenskars%2oresande%20-%20en%20j%C3%A4mf%C3%B6rande%2ostudie.pdf>

Web

Bergstedt, T. (2019, September 20). Besöksrekord i svenska fjällen. *SVT Nyheter*. Retrieved from <https://www.svt.se/nyheter/inrikes/besoksrekord-i-svenska-fjallen>

Gränslandet, an information project by: Jämtland and Dalarna county administrative boards, Hedmark and Sør-Trøndelag county governors. (2011). *Gränslandet*. Retrieved from <http://www.grenslandet.no/en/>

Lovdata. (2013). *Forskrift om verneplan for Femundsmarka, vedlegg 1, vern av Femundsmarka nasjonalpark, Roros og Engerdal kommuner, Sør-Trøndelag og Hedmark*. Retrieved from <https://lovdata.no/dokument/LF/forskrift/1971-07-09-6/%C2%A73#%C2%A73>

Piesing, M. (2019). *How airships could return to our crowded skies*. Retrieved from <https://www.bbc.com/future/article/20191107-how-airships-could-return-to-our-crowded-skies>

Rosenblad, J., Söderholm, G. (2014). *Nationalromantiken*. Retrieved from <https://www.so-rummet.se/fakta-artiklar/nationalromantiken>

Svenska Turistföreningen. (n.d.). *Grövelsjöfjällen och Rogen*. Retrieved from <https://www.svenskaturistforeningen.se/guider-tips/omraden/grovelsofjallen-och-rogen/>

Images

Figure 1. Liljefors, B. (1919). *Höstbacke med råv* [Online Image]. Retrieved from https://commons.wikimedia.org/wiki/File:Bruno_Liljefors_-_H%C3%B6stbacke_med_r%C3%A4v_1919.jpg

Figure 2. Larsson, C. (1905). *Harvesting ice blocks* [Online Image]. Retrieved from <https://www.flickr.com/photos/eoskins/16485114262>

Figure 3. Svanerud, L. (2019). *Brennbåmmåren, Norge med Femunden*. Reprinted with permission.

Figure 4. Genberg, A. (1898). *Norrländsk Fäbovall* [Online Image]. Retrieved from https://sv.m.wikipedia.org/wiki/Fil:Anton_Genberg_-_Norr%C3%A4ndsk_f%C3%A4bovall.jpg

Figure 5. Andreaze. (2017). *The trail from Skedbro to Rogen have lot of stones* [Online Image]. Retrieved from https://commons.wikimedia.org/wiki/File:Rogens_naturreservat_4.jpg

Figure 6. Andreaze. (2017). *A small lake in Rogens nature reserves* [Online Image]. https://commons.wikimedia.org/wiki/File:Rogens_naturreservat_2.jpg

Figure 7. Andreaze. (2017). *Stones and old trees in Rogens nature reserves* [Online Image]. Retrieved from https://commons.wikimedia.org/wiki/File:Rogens_naturreservat_6.jpg

All other photos and graphics belong to the author.

thanks to

First of all a big thanks to the Urban Challenges team and especially my examiner Joaquim Tarrasó and supervisor Kengo Skorick.

To the team at STF Grövelsjön Fjällstation for giving me such a wonderful stay during my study trip. Special thanks to manager Carl Johan Ingeström for meeting with me and discussing my thesis, and to Lars Svanerud for providing images of the site.

To Simon Niva for helping me with all my questions regarding building with wood, details and solutions.

To all my friends and colleagues at Chalmers, especially Rebecka, Hanna and Karl.

To my family for your endless support and for always believing in me and asking the critical questions such as "where do I store my backpack in this cabin?".

And last but not least to Oscar for always being there, following every step and acting as final decision maker.

appendix

- 01** Architecture vs Nature
- 02** Site visit timeplan + photos
- 03** Searching for artefacts
- 04** Composition 01 - Context + Site Analysis
- 05** Composition 02 - Concept + Proposal

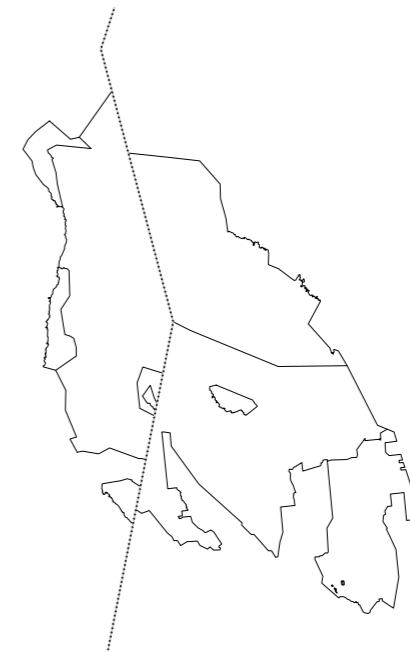

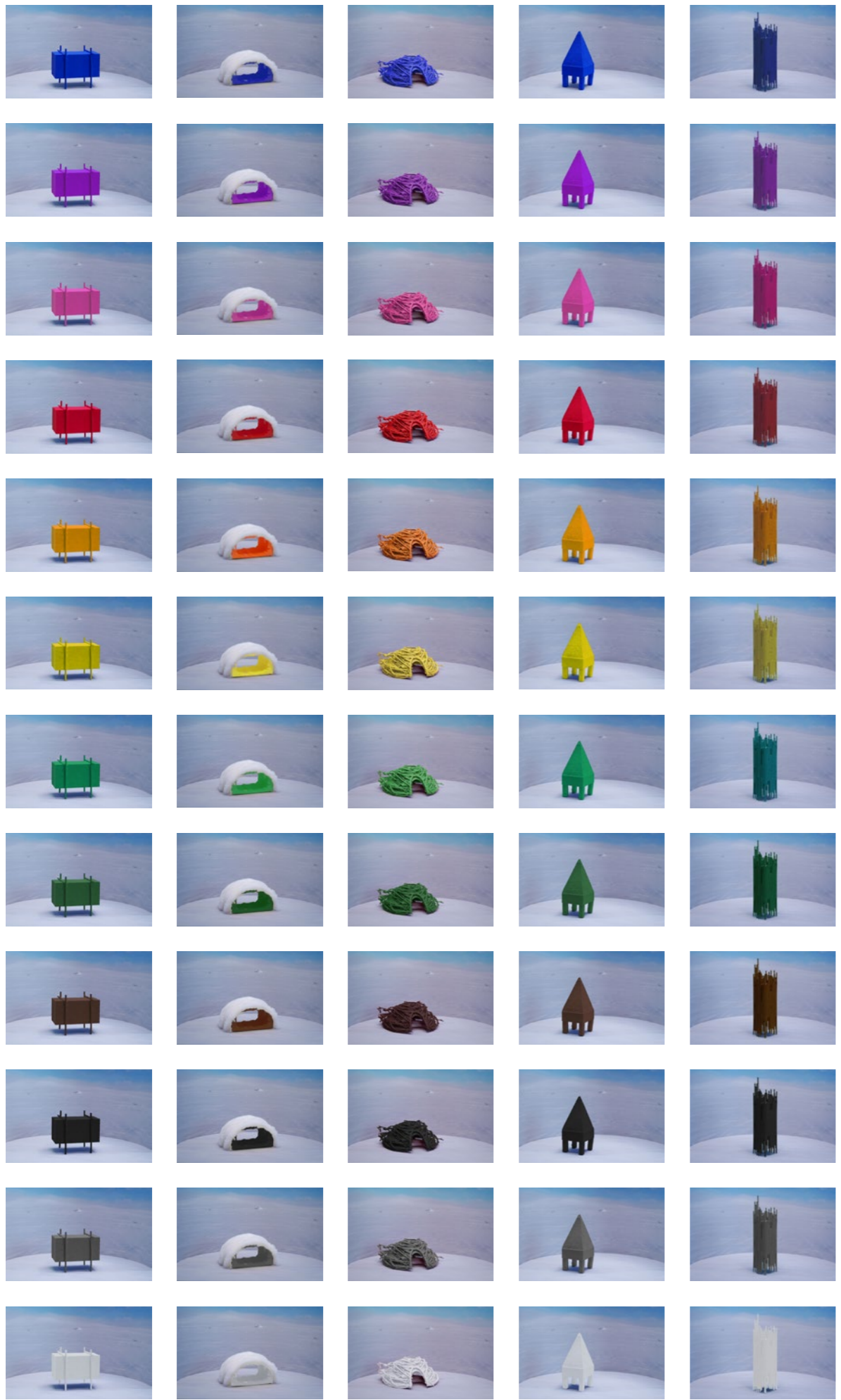

Site visit timeplan

Saturday
08.02.2020
10:15 - Bus from Gothenburg
18:50 - Arrival in Idre
19:00 - 45 minute car ride to Grövelsjön
Check in at STF Grövelsjön Mountain Station

Sunday
09.02.2020
Morning: Renting and testing cross-country skiing equipment.
Afternoon: guided tour about safety and navigation in the mountains.

Monday
10.02.2020
13 km ski trip to Hävlingestugorna.
Spend the night at Hävlingestugorna to experience a cabin stay with no electricity or tap water.

Tuesday
11.02.2020
13 km ski trip back to Grövelsjön.
20:00 - lecture by a local Sami about reindeer herding

Wednesday
12.02.2020
Visit Idre and explore the contrast between untouched nature and an exploited alpine skiing resort.

Thursday
13.02.2020
Mapping the current tourism infrastructure on the site.
14:00 - meeting with STF Grövelsjön's manager Carl Johan Ingeström

Friday
14.02.2020
Full day ski trip into Norway. Visiting an old mountain farm: *Valdalsbygget*.

Saturday
15.02.2020
10:00 - Car ride from Grövelsjön
10:50 - Bus from Idre
19:25 - Arrival in Gothenburg

During my stay in Gränslandet I mapped the site by drawing mental maps and sections at the end of each day. I spent a lot of time photographing the landscape and buildings and talking to people in the area.



Hävlingestugorna



solar panels



melting snow



Långfjället



Särsjöbäcken



Idre



Signs and trail map



left ski: Sweden, right ski: Norway



Lifjellet + Salsfjellet



Wind shelter



Old settlement



Valdalsbygget

Searching for artefacts



Too complex



Too tentlike



Too simple



Too big



Too tall



Too different



Too sharp



Too strange



Too plump



Perfect!

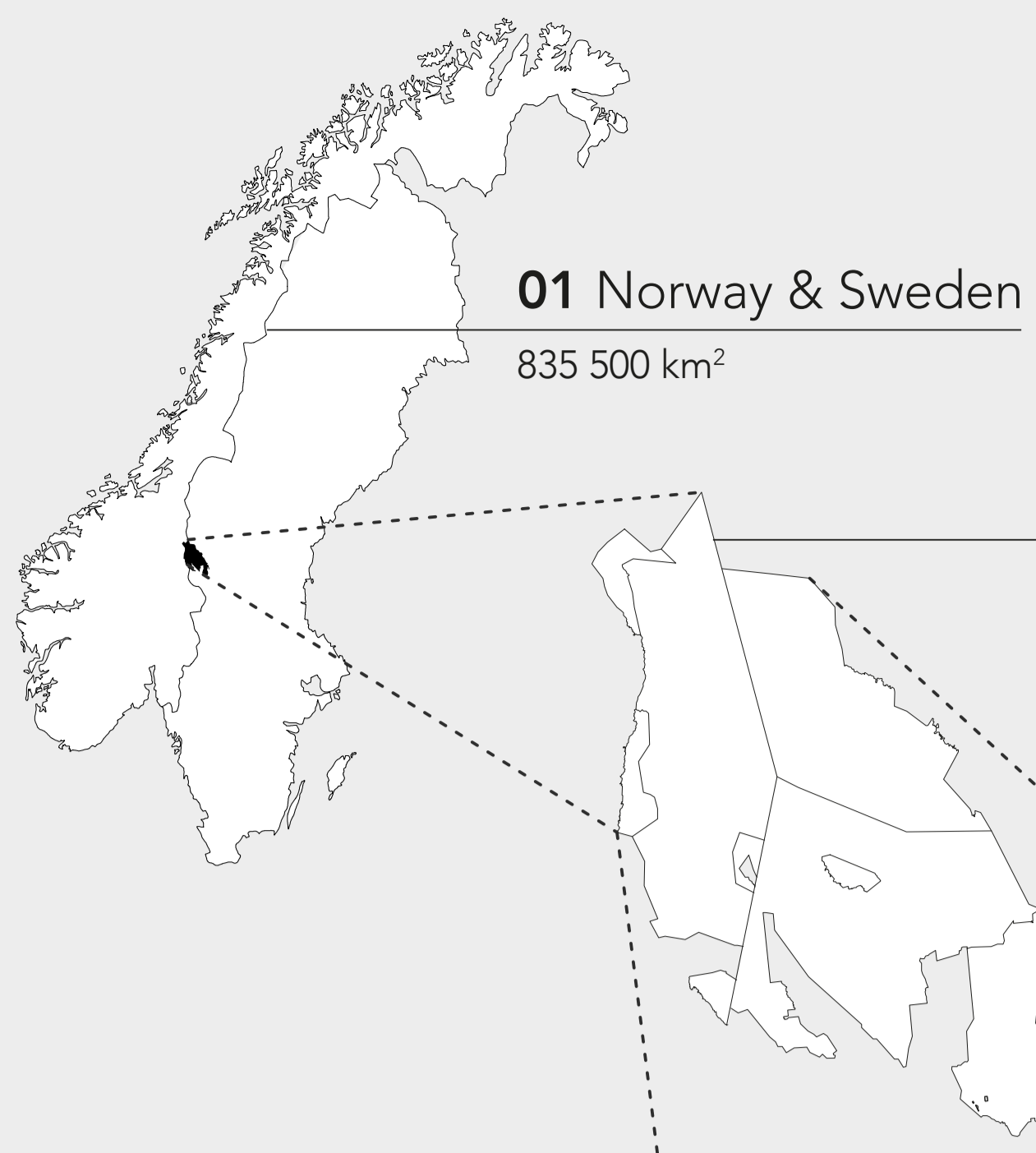

02 Gränslandet
2000 km²
9 areas of protected nature situated on the southern tip of the Scandinavian Mountain range, crossing over the border of Norway and Sweden.

NORWAY
SWEDEN

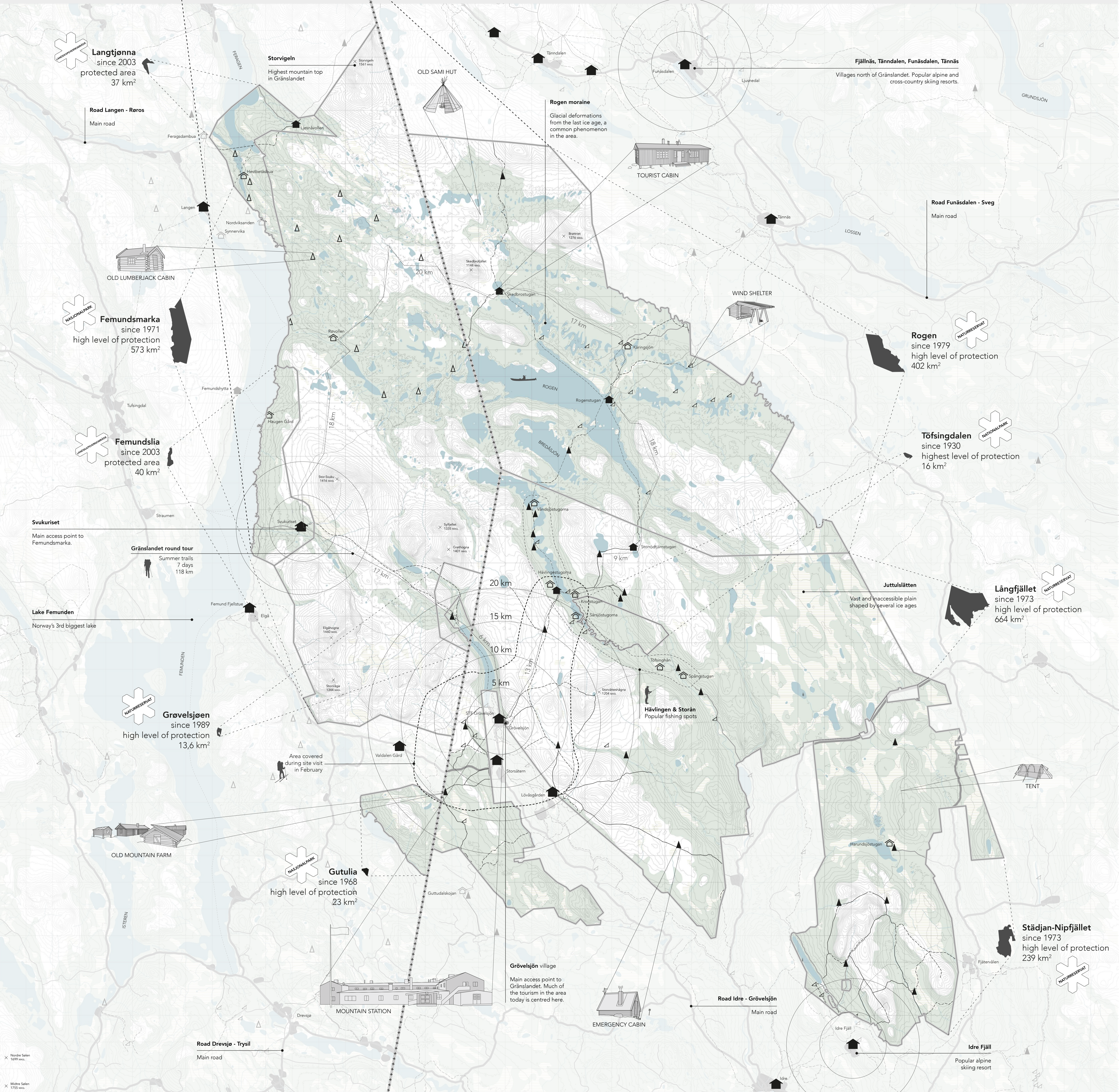
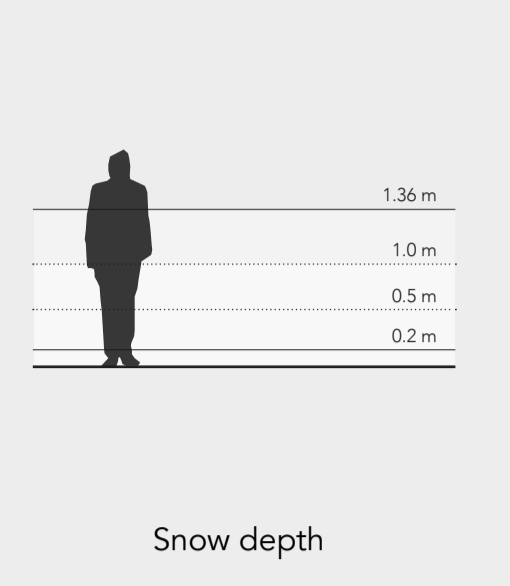
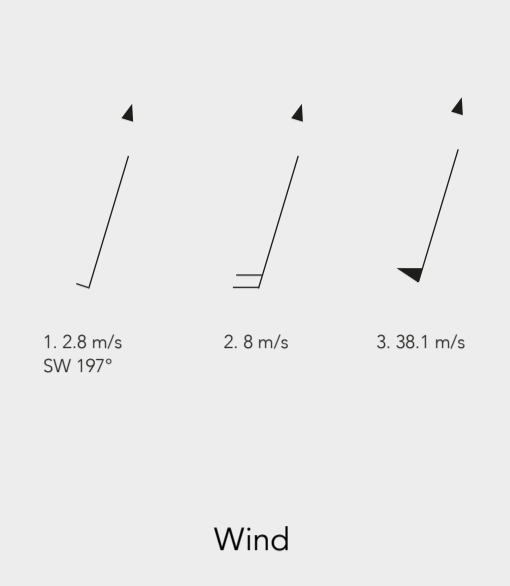
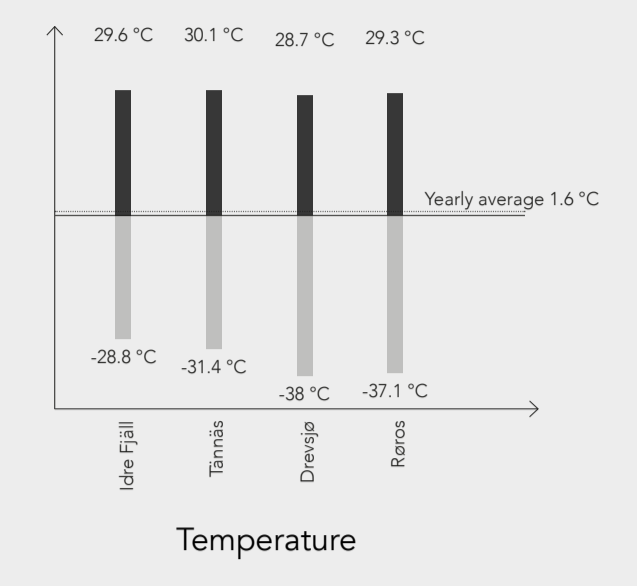
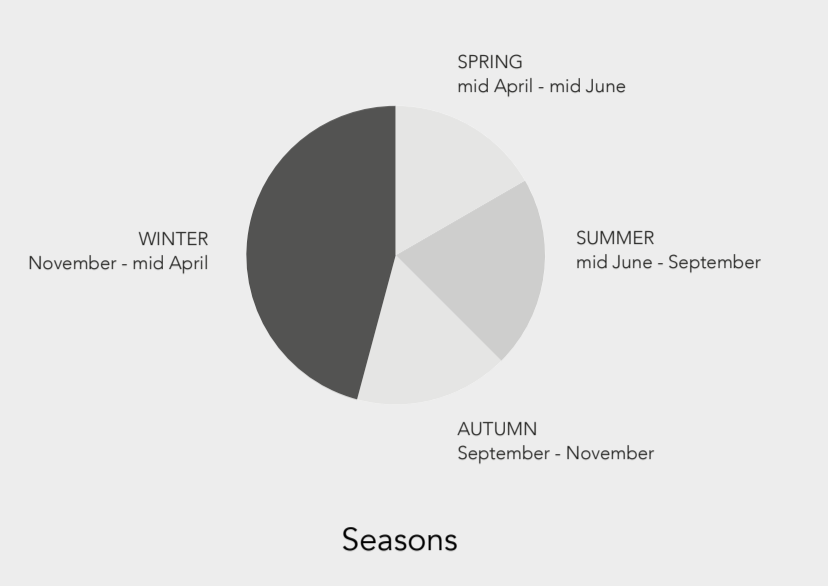
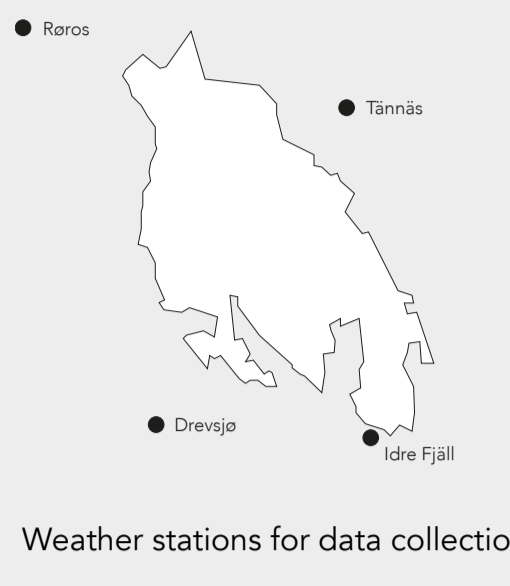
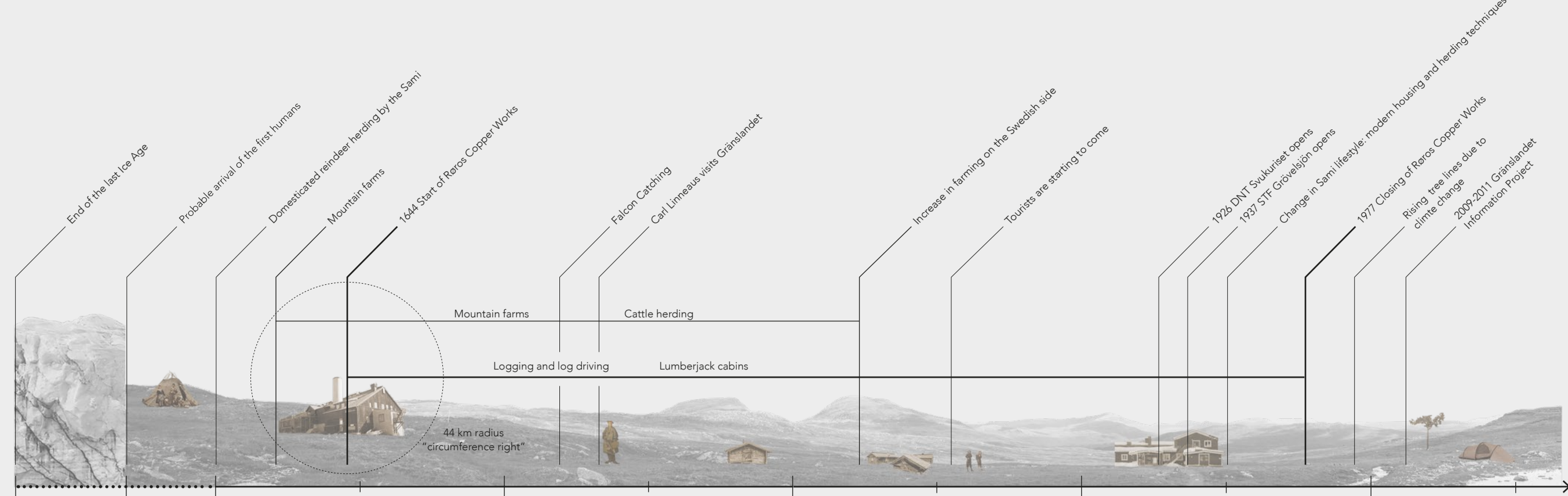

GRÄNSLAND

01 Context + Site Analysis

NORWAY
SWEDEN

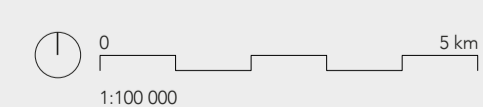

- Hotel / Hostel / Mountain station
- Source Cabin
- Unstaffed Tourist Cabin
- Emergency hut
- Open hut
- Wind shelter
- Contour lines
- Built-up areas
- Forest
- Marsh | Bog | Mine
- Lake
- National boundary
- Nature protection boundary
- Marked summer and winter trail
- Marked summer trail
- Marked winter trail
- Marked trail on ice
- Marked trail on ice
- Root route
- Rigger road
- Smaller road
- River

- Available accommodation on site (close by)
- 1 (14) Hotel / Hostel
 - 5 (1) Staffed cabin
 - 12 (3) Unstaffed cabin
 - 15 Open Hut
 - 23 Emergency Hut
 - 24 Windshelter

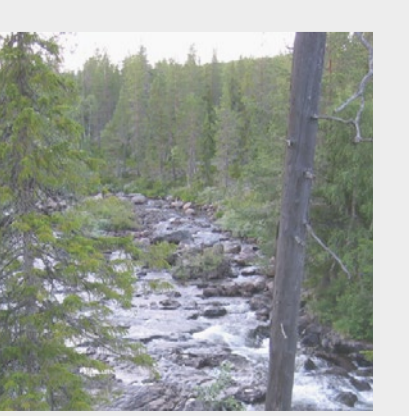
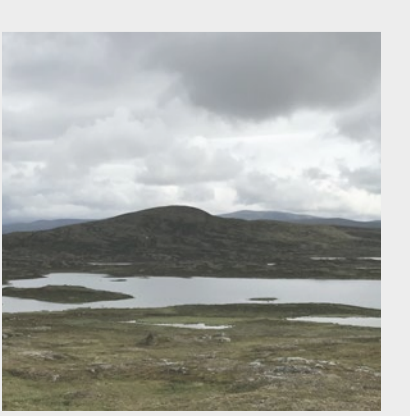
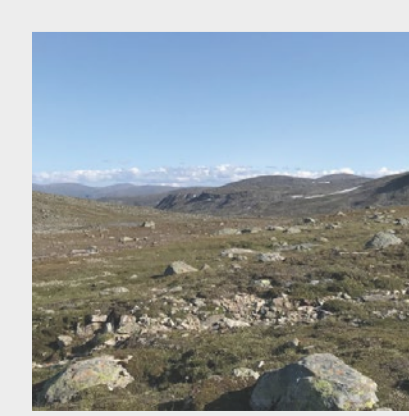

GRÄNSLAND

02 Concept + Proposal


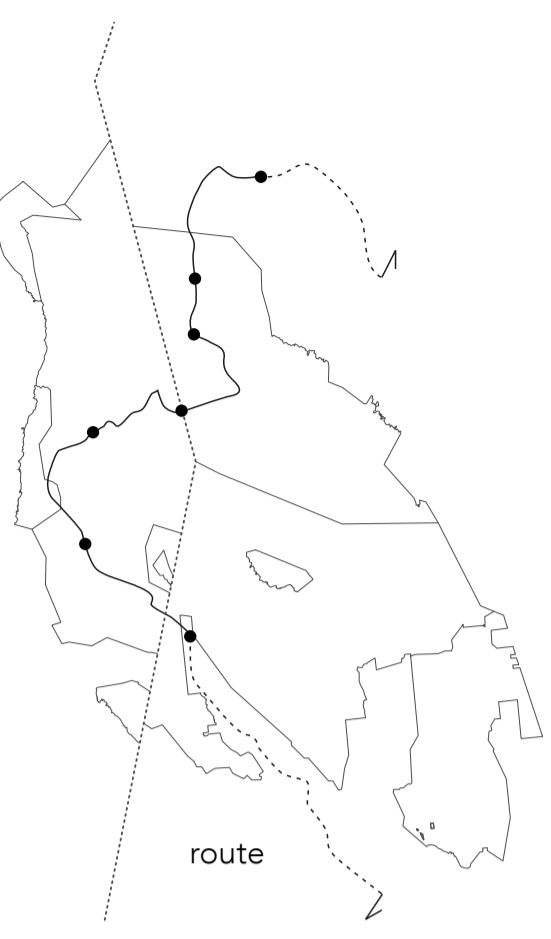

- The Cabin
- The Observation Shelter
- The Border Station
- Hotel | Hostel | Mountain Station
- Tourist Cabin
- Open hut
- Emergency hut
- Wind shelter
- National boundary
- Nature protection boundary