

RECLAIMED IDENTITY

- a restaurant and dwellings in Klövsjö

Anna Tegay

Master thesis 2024

Chalmers School of Architecture

Department of Architecture & Civil Engineering

Examiner: Mikael Ekegren

Supervisor: Björn Gross



Anna Tegay

Reclaimed Identity
- a restaurant and dwellings in Klövsjö

Chalmers School of Architecture
Department of Architecture & Civil Engineering
Examiner: Mikael Ekegren
Supervisor: Björn Gross

Acknowledgements

Many thanks to,

Björn Gross for valuable guidance and encouragement.

Mikael Ekegren for constructive feedback and advice.

Family and friends for immense patience and support.

- 2021 - Master Programme in Architecture and Urban Design,
Chalmers University of Technology
- Sustainable Development and the Design Professions*
Matter Space Structure
Architectural Competitions
History, Theory and Method
Housing Inventions
- 2022 - 2023 Architectural Intern
Scott Rasmusson Källander, Stockholm
- 2020 - 2021 Architectural Intern
Cobe, Copenhagen
- 2017 - 2020 Bachelor Programme in Architecture,
Chalmers University of Technology

With the increase in mountain tourism, visitors from all over the country and world travel to the scenic landscapes of northern Sweden to experience its nature during different seasons of the year. However, the high demand leads to an increased exploitation of the historic environments of the mountain villages. By exploring the concept of identity, delving into the theories of critical regionalism, and studying traditional building techniques, this thesis aims to synthesize these elements into a design that strikes a balance between honoring local identity and embracing change without resorting to imitation and historization.

The central question explored is how a design proposal for a restaurant and dwellings in the mountain area of Klövsjö can be informed by the local identity. The project unfolds across three phases; theoretical studies, site analysis and design iterations, resulting in a design proposal.

The project is situated in a small village named Klövsjö, located in the southern parts of Jämtland. On top of being a well-frequented destination for hiking, cross country- and alpine skiing, the entire village of Klövsjö is part of a larger area of national interest for cultural environmental protection. Adjacent to Svartåstjärnen, the project site serves as a transitional space between the public amenities of the ski village and the private housing area, resulting in the mixed program of the project.

Informed by the principles of log construction, the design proposal utilizes various techniques in accordance to the specific program of each building. These techniques range from demanding and robust log timbering methods to more lightweight versions that challenge traditional norms, creating a dialogue between tradition and innovation.

The thesis concludes with a reflection on the malleable nature of the concept of identity, with its significance lying not in rigid definition but rather in the contemplation of it. By crafting spaces that honor the past while embracing the future, weaving together elements of tradition, innovation, and local identity, the project seeks to create spaces that spark dialogue and evoke thoughtful consideration of the context.

TABLE OF CONTENTS

Introduction	Academic framework	10
I. Theory	On tradition, critical regionalism and identity	14
	Built references	16
II. Context	Sweden	20
	Klövsjö village	22
	Site visits: Identifying the character of Klövsjö	26
	Log construction	30
	Klövsjö ski village	36
III. Design proposal	Project site	42
	Space diagrams and program	44
	Restaurant	48
	Dwellings	64
	Sauna	80
IV. Conclusion	Discussion	90
	Bibliography and figures	92

Introduction

ACADEMIC FRAMEWORK

Background

Mountain tourism has heavily increased over the years and visitors from all over the country and world travel to the northern areas of Sweden to experience the majestic nature and outdoor activities during all seasons of the year. Tourism in Jämtland Härjedalen had a turnover of approximately 7 billion SEK in 2022 and a total of 12 million guest nights (Jämtland Härjedalen Turism, 2023). The region is therefore one of the most tourism-dependent in Sweden where tourism generates many work opportunities and economic development. As much as 58% of the total tourism-revenue in the county comes from commercial living such as rented accommodation and hotels.

According to The Public Health Agency of Sweden (2023), contact with nature promotes both our physical and mental health and the authority is responsible for the ninth goal of the Outdoor Life Policy which is about creating conditions for people to be able to spend time outside in nature. They state that many forms of outdoor recreation involve physical activity but also the opportunity for relaxation, recreation and recovery.

It is inevitable to acknowledge that mountain tourism spurs not only economic development in the region of Jämtland but also offers private individuals the opportunity for recreation and valuable experiences. Consequently, the attraction towards the mountainous landscapes and the continued development of them is self-evident. But with the increased demand also comes a higher exploitation of the distinct historic environments. It is therefore imperative that we contemplate on the significance of the local identities; what they have been historically, what they are today and how they can inform the new layer for the future.

Subject

This thesis explores the activities associated with visiting and residing in the Klövsjö area, focusing on integrating them into a design that honors the local identity.

The primary concern addressed in this thesis is the loss of character resulting from the development of mountain destinations which do not take the local identity in regard. The exploration of this concern is conducted through a combination of theoretical and architectural investigations of relevant theories and built references. The study also experiments with how studies of the local context, its history and built structures in combination with contemporary solutions can take shape in new built structures in the area.

Research question

How can a contemporary design proposal for a restaurant and dwellings in the mountain area of Klövsjö be informed by the local identity?

Aim

The intention is to through design create additional dwellings and restaurant to the ski village of Klövsjö that connect with the local identity and develops the traditional building design without mimicing and historicizing it.

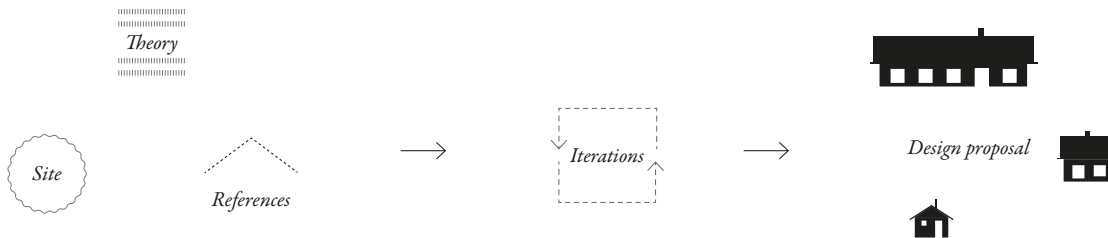

Delimitations

This thesis focuses on investigating how one can work with a number of distinctive aspects of a specific context in an area which is characterized both by rural surroundings and tourism-driven development. The chosen site is located within the tourist destination and the program is therefore directed for that target group.

The project does not seek to present a solution to the intricate discussion on mountain tourism and the exploitation of rural villages. Instead it embraces the challenge of developing tradition and crafting new spaces with respect for the existing.

Additionally, it presents only one design proposal for the specific site and does not aim to present a universal approach for all new structures in the mountain area.

Reading instructions

The thesis is divided into four parts. Part I introduces the theoretical framework including literature and built references. Part II delves into the context, reflecting on specific characteristics and investigating the traditional building traditions of log timber construction. Part III presents the design proposal. Lastly, Part IV is a conclusive discussion of the findings and implications of the study.

Method

The project unfolds across three phases with a research by design based methodology. It involves a theoretical phase, context analysis, and design phase. The theoretical phase involves a study of literature and analyses of relevant built projects. This, coupled with the findings from the site analysis, establishes the framework that guides the experimental design phase. The design phase involves sketches in both physical and digital form, culminating in the final design proposal.

I.

Theory and built references

ON TRADITION, CRITICAL REGIONALISM AND IDENTITY

Regionalism and tradition

Vincent B. Canizaro (2007) defines a region as a large area delineated by a variety of cultural and natural parameters. These encompass climate, topographic features, construction materials, and architectural styles. He writes that regionalism can be described as a strategy, concept or attitude. Collectively, it is a theory which opposes itself to universal and standardizing structures that diminish local differentiation. He states that the dialectic of tradition and modernity is inevitably linked to the struggle between necessary cultural continuity and the desire for progress and innovation. Canizaro suggests that traditions, at their best, embody cultural knowledge and provide a dynamic framework for growth and change. However, at their worst, traditions can become stagnant, hindering progress and development.

Critical Regionalism

In 'Towards a Critical Regionalism: Six Points for an Architecture of Resistance' Kenneth Frampton (1983) presents his approach with the objective to counteract the placelessness of universal and standardized structures. Simultaneously, he advocates for the removal of oneself from the inclination to historicize. The approach of Critical Regionalism is aimed to balance the influence of universality with elements that are inspired by the unique qualities of a specific place. This can involve deriving design from local characteristics such as the quality of light, a tectonic inspired by a distinctive structural mode or in the topography of the specific site. But crucial to emphasize is that it is important to differentiate the approach from banal efforts to resurrect lost vernacular forms.

Critical Regionalism can be understood in different ways; it can be a compositional grasp of the base figure of the project, an interest in the cultural and physical histories of a specific site, or an acknowledgment of the technical limitations and potentials of a site (Szacka & Patteeuw, 2019). Although the writings of Kenneth Frampton swiftly became historical documents, the texts have more significance today than being mere historical artefacts. His ideas brought about essential concepts such as authenticity, tactility, materiality and tectonics into architecture, which are ideas that remain highly relevant today when practitioners need to have a certain sensitivity towards the qualities of the specific context in which the projects are situated. Furthermore, the appeal and necessity of local materials, building knowledge and craftsmanship have grown amid the ongoing ecological transition today, characterized by short cycles and economic constraints.

Identity

When speaking of identity and his use of the traditional log construction technique, Gion A. Caminada says that identity is lasting and that something which is highly valuable can lead to identity but that it can also be created. He explains that a 'type' is the opposite of a 'model', where a model is always the same as itself whereas types vary depending on the conditions that influence the place - the topos. Further elaborating on this he says "Houses are either built of stone, timber or other materials, which is a response to the climate and the natural features, in all of which people also play an important role. So if in a certain place certain things have traditionally been used in a very special way, that circumstance has marked the place; it has identified it culturally." (El Croquis, 2021, p.11).

Caminada emphasizes that although log buildings around the the regions of his projects are alike, they are never identical, which creates a sophisticated spirit (Aicher, 2018). He says that 'identical' would be monotonous, but the 'almost identical' on the other hand has a fascinating and powerful effect to create a place. He therefore concludes that there can not be identity without difference.

Essence of place

Christian Norberg-Schulz's theoretical work emphasizes the significance of place in architecture, aiming to establish an architectural phenomenology. In his text "Genius Loci: Towards a Phenomenology of Architecture" (1991) he argues that place transcends a mere abstract location, and instead refers to a combination of concrete elements such as shape, texture and color, which collectively contribute to an "environmental character," defining the essence of a place. Norberg-Schulz describes character, as both more general and a more specific concept than space. On one hand it stands for a general atmosphere, and on the other, the distinct form and substance of the space-defining elements.

Schulz describes the concept of Genius Loci, which originates from the Romans, who believed that every independent being had its guardian spirit, its genius, and this spirit was said to give life to people and places. This concept has remained relevant in arts throughout history, although not always named under the same term. Architecture can in a way be said to concretize the genius loci, and one can therefore say that the fundamental task of architecture is to understand the inherent "vocation" of the place.

Robustness and sincerity

Johan Celsing writes in his text 'The robust, the Sincere' (2010) that for architecture to add to the advancement of sustainability and to be taken seriously it needs to be robust. This is because architecture is a slow medium which demands considerable resources for its actualization. Celsing clarifies that the robust does not represent the sturdy and strong, but rather the lasting and the multifaceted. He expands on this and describes the robust as that which predicates both tangible and intangible aspects of the context, such as the specific surroundings, social context, history and current social role. It aims to synthesize these circumstances into the form of buildings which have no particular stylistic form.

Celsing describes the sincere as that which regards, as opposed to the robust, the unarchitectonic elements of building such as playfulness, tenacity and courage. Although it has less to do with the materialization of building, it is of fundamental importance since the work should first and foremost serve the users. The sincere is part of the care with which the building has been designed, it implements presence and warmth and does not insist on attention but rather gives a subtle invitation for dialogue.

BUILT REFERENCES

Stiva da Morts, Gion A. Caminada (1996)

This project is a community mourning place located in the village of Vrin, Switzerland (Hidden Architecture, 2018). The placement of the building between village and cemetery is in a subtle manner represented in its design, connecting with the surrounding village houses through its timber construction and simultaneously speaking to the sacrality of the church through the white colored finish.

The double log wall construction emits a sturdy presence to both the exterior and interior of the structure. Furthermore, the concrete base enhances the building's integration with the landscape, creating a sense of stability.

Walpen House, Gion. A Caminada (2002)

This house lies in the outskirts of the village of Blatten and is built with similar principles as the local buildings. The log structure rests on stone walls that create a storage zone beneath the volume. The interior is dominated with the exposed log construction except for the bedrooms which are clad on the inside and therefore emit a more refined appearance.

This project presents an interesting mix of exposed log construction and interior cladding, demonstrating a method of honoring local building traditions while simultaneously forging its own distinctive identity.

Studilandsbyen, Lenschow & Pihlmann (2007)

The student housing is located just outside Aarhus and consists of several additions around a renovated 17th century half-timber farm (Divisare, 2018). The additional volumes mimic the form of the original farmhouse but employ wood as the predominant facade material, thus establishing a distinct boundary between the old and the new.

The arrangement and orientation of the buildings give rise to internal "streets" which also influence the degree of openness of the facades. The configuration of new building volumes surrounding the original structure fosters a new dynamic outdoor-environment, while the design language maintains a dialogue with the historic context of the area.

Nannberga, General Architecture (2011)

This project was initially a timber storage house, a so called "härbre" (General Architecture, n.d.). It was disassembled and moved to a new site where it was turned into a vacation cottage. In between the original bottom and top half, a stud wall was added in order to create a full second storey.

This project exemplifies a method of working with historic structures, incorporating an addition which is both sincere and respectful to its heritage yet distinctive in its character.



Figure 1. Stiva da Morts.
(Smidek, n.d.)



Figure 2. Stiva da Morts Interior.
(Smidek, n.d.)



Figure 3. Floor plan.
(Caminada, n.d.)



Figure 4. Walpen House.
(Granada, n.d.)



Figure 5. Construction first floor plan.
(El Croquis, 2021)



Figure 6. Walpen House Interior.
(Granada, n.d.)



Figure 7. Original structure.
(No author, n.d.)



Figure 8. Studielandsbyen.
(Berndtson, n.d.)



Figure 9. Floor plan.
(Lenschow & Pihlmann, n.d.)



Figure 10. Nannberga.
(Grootveld & Olsson, n.d.)

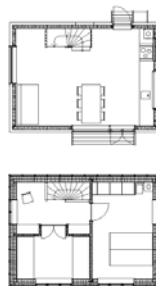

Figure 11. Floor plans.
(General Architecture, 2023)

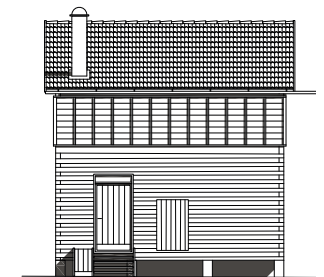

Figure 12. Facade.
(General Architecture, 2023)

II.

Context



Figure 13. Sweden Map.
(Lantmäteriet, 2023)

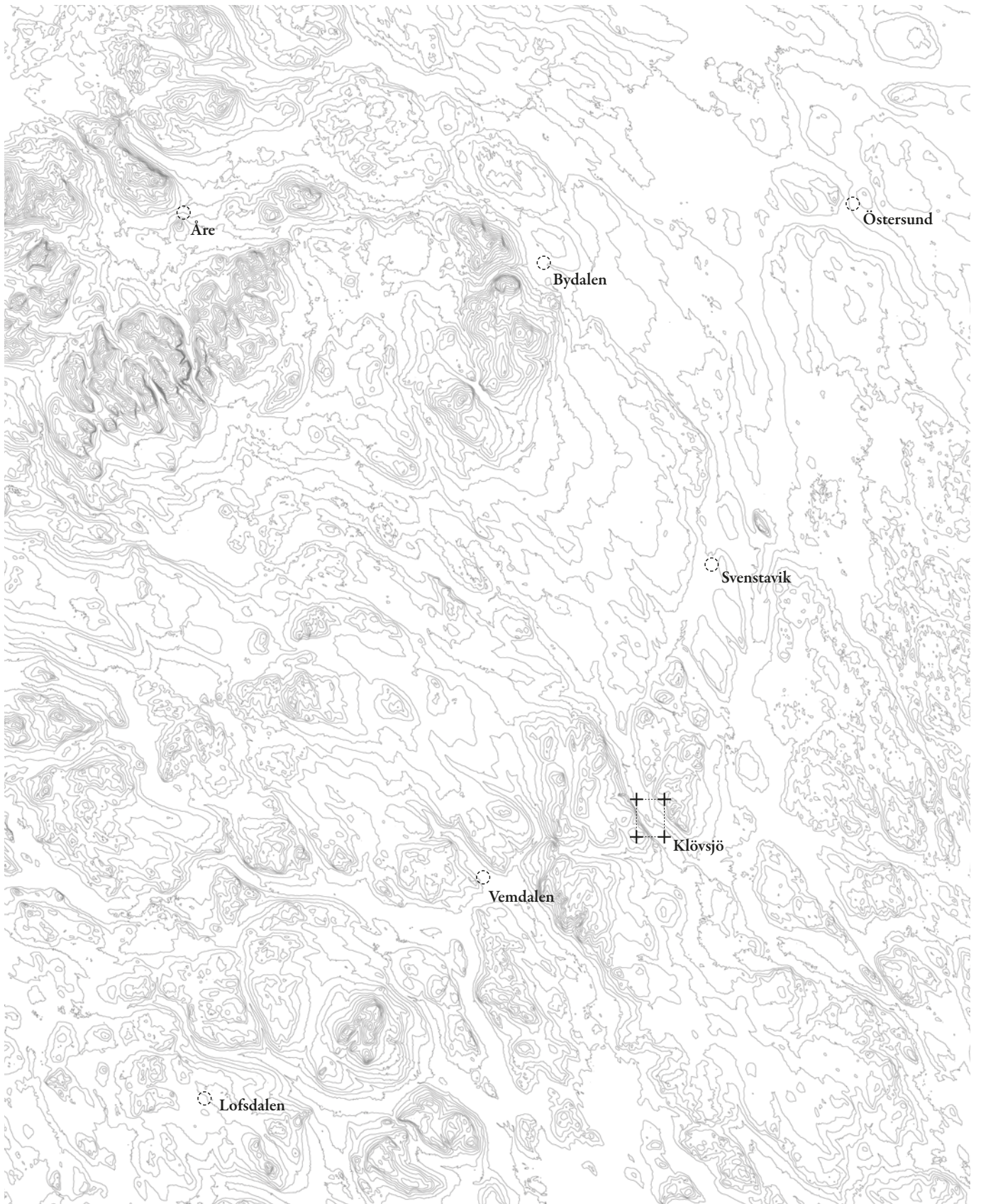

KLÖVSJÖ VILLAGE

Klövsjö is a small community located in low mountain terrain in Bergs kommun, Jämtland with around 340 permanent residents (SCB, 2020). It is part of Destination Vemdalen and has hiking trails, ski lifts and cross country skiing tracks that connect with the ski and hiking destination Storhogna in West (Destination Vemdalen, n.d.). The area has all basic community functions such as school, pre-school, grocery store and so on. In addition to this, the village is known for its culinary crafts with a stone oven bakery, brewery, restaurants and local farm shops. Less than four kilometres from the village centre is the alpine ski system, cross country skiing tracks and starting points for the summer trails. The alpine ski system of Klövsjö-Storhogna consists of 14 lifts, 21 pistes, a ski-park and several restaurants and cafés.

The village is situated on a West-leaning slope down towards Lake Klövsjön, which has historically been a favourable condition for cultivation. The open farmlands and scattered wooden buildings are characterizing for the place and the village is part of a larger area of national interest for cultural environmental protection (Riksantikvarieämbetet, 2012). The motivation for this is that the village encloses a cultivation-landscape and contains a number of shack environments on the forest heights and in the low mountain terrain around the lake. Furthermore, there is a multitude of preserved timber buildings in the village dating back to the 16th century and onwards.

Among them is Tomtangården which is a formation of log buildings standing in an enclosed structure at their original location (Länsstyrelsen Jämtlands län, n.d.). These kinds of enclosed structures with houses for dwelling and farmhouses interconnected were common for northern Sweden during the 18th century. As agricultural reforms unfolded during the same period, numerous buildings from the enclosed farms were relocated. Today, many sites only bear remnants of the original enclosed structures (Jamtli, 2007).

Situated around the lake and along the edges of the forest heights are the old shack environments which were used for mountain farming. Mountain farming has historically been a vital part of agriculture in Sweden and Norway since it enabled larger pastures during summertime (Västernorrlands museum, n.d.). To the west of Lake Klövsjön, situated higher up in the mountain terrain, lies Bräckvallen, one of the few remaining active shack farms that still adhere to traditional practices (Destination Vemdalen, n.d.). During the summer months, the animals are taken by foot to this location from the second shack, which is positioned along the shoreline of the lake.

- | | |
|----------------------|--------------------------------|
| 1. Supermarket | 6. Brewery |
| 2. Church | 7. Swimming spot |
| 3. Klövsjön | 8. Hiking trail to Bräckvallen |
| 4. Tomtangården | 9. Katrina Ski Village |
| 5. Stone oven bakery | |



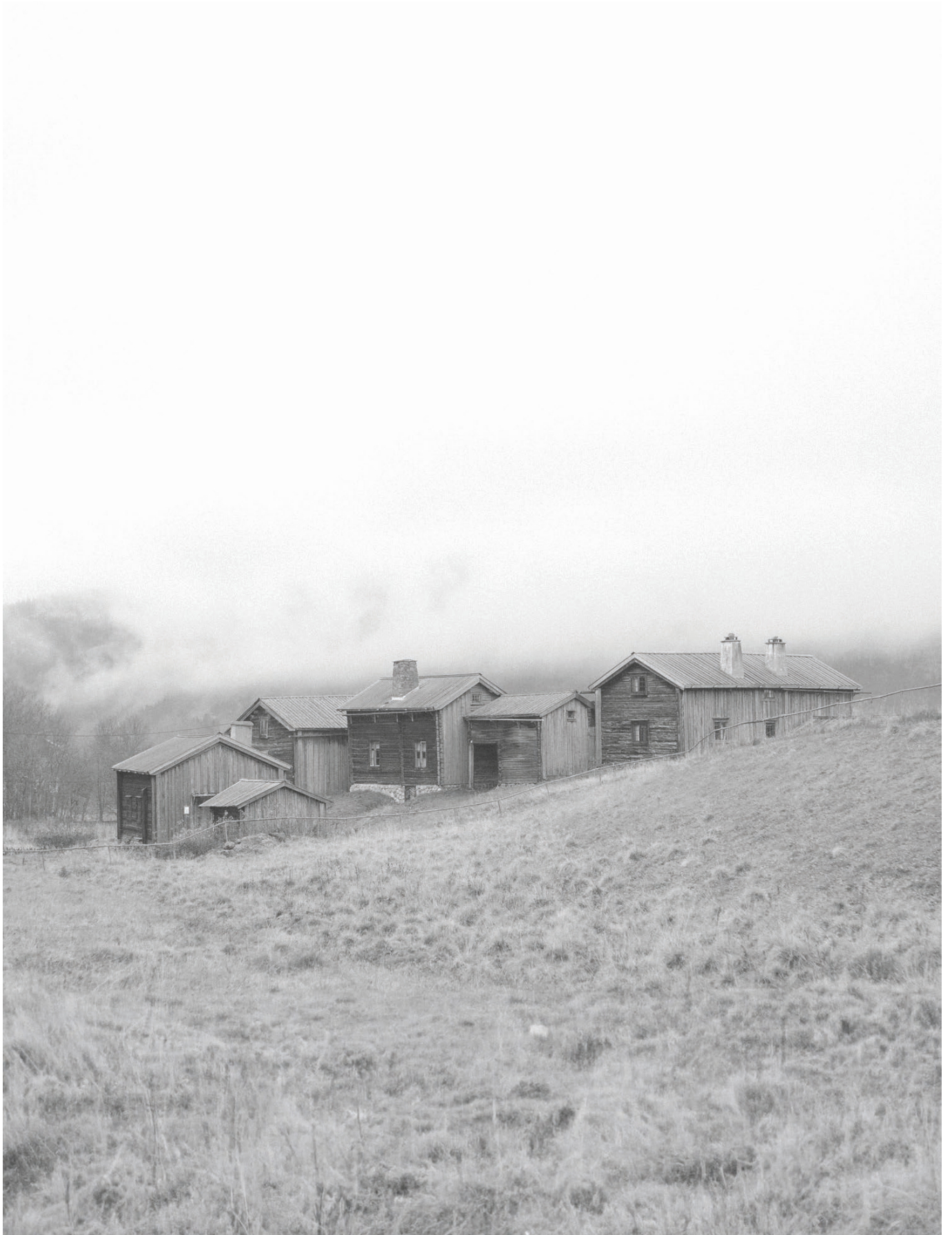

Tomtangården.

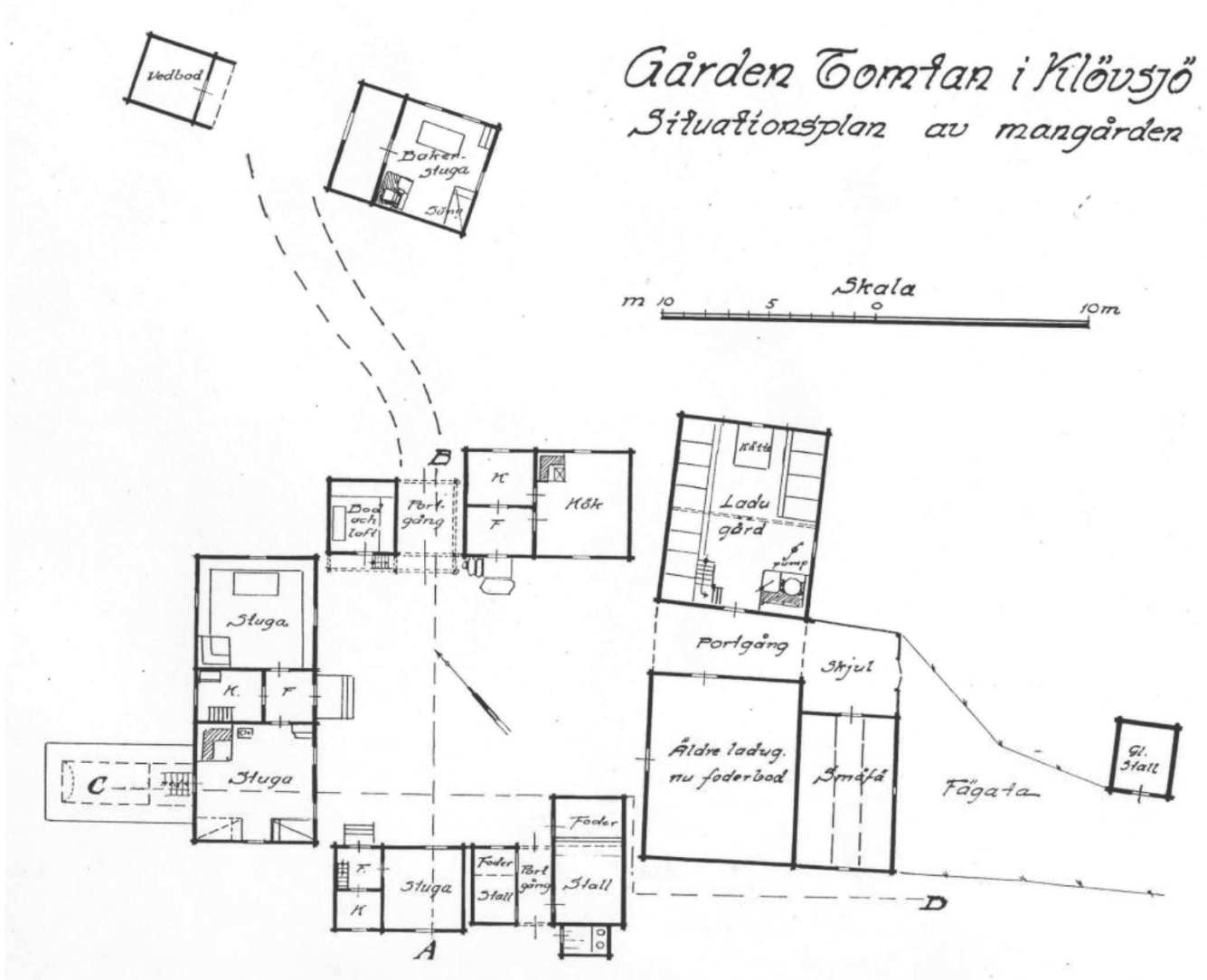

Figure 14. Site plan Tomtangården. (Jamtli, 2009).

SITE VISITS: IDENTIFYING THE CHARACTER OF KLÖVSJÖ

Although Tomtangården is the only completely enclosed structure left in Klövsjö today, one can see that many of the farms have previously looked the same. On the old farm sites, the buildings are often placed around a courtyard and the functions are divided into separate buildings. On many of the farms several of the outhouses are closely positioned while the residential buildings have more space in between, and most main entrances face the courtyard.

Wood serves as the predominant building material around the village, albeit with variations in construction technique ranging from simple log structures to log constructions that are insulated and clad in wood panels, and a number of contemporary regular stud wall constructions.

When analyzing the language of form, one can see that the area predominantly features traditional gable roofs, with a relatively low building scale ranging from one to two storeys. Although structures are similar to one another the configuration of volumes standing in angle to one another and the sloping topography together create an interplay between the structures and contribute to a dynamic environment within each village plot.

Visiting the village in fall, the first impression is that of a serene and unhurried environment. Some original structures on old farmsteads are visibly in use and one encounters mostly locals on the roads. Fall is more of an off-season in the area and most tourism-centered services are closed, but it is still evident that village is known for its culinary arts, offering a range of experiences from farm shops, a stone oven bakery, a brewery and restaurant.

During summer and winter, it is clear that there is a strong culture of outdoor activities such as skiing, fishing, hiking and golfing. A reason for this is the strong presence of forest, mountains and water. The lake provides a scenic backdrop visible from most vantage points around the village, while the forest serves as a majestic and organic framing of the entire area.

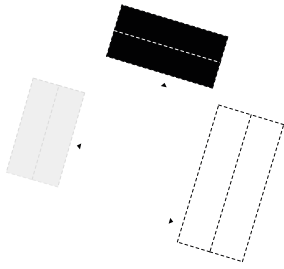

Different functions in separate buildings

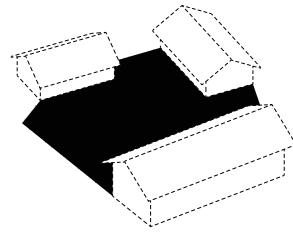

Framed courtyards

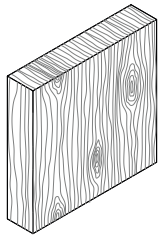

Wood

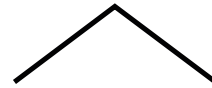

Gabled roofs

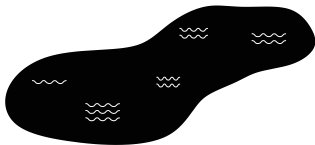

Presence of water

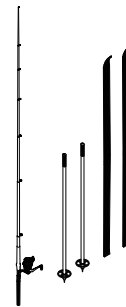

Recreational values



Connection with forest



Culinary arts



Foggy day in the village



Red house in the village



Original log timber structure



Tomtangården



Härbre and barn



'Gårdsgård' fence



Gravel road to Tomtangården



Original log timber structure



Old barn



Farmstead still in use

LOG CONSTRUCTION

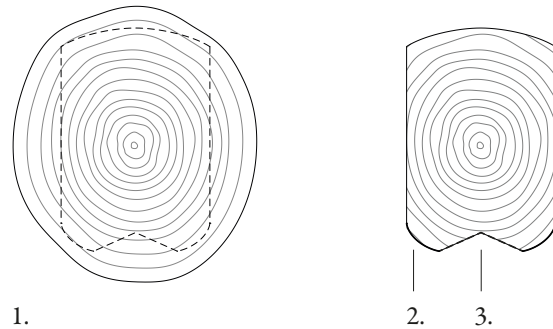

1. Piece of timber used for logs
2. Såt
3. Drag

The Swedish countryside is characterized by wooden houses assembled with knots and joints. The log building culture is diverse but often hidden behind red-painted panels or plastered facades. Timber-framed houses have been present in the Nordic countries for at least 1000 years and they reflect rooted ideas about aesthetics and functionality in both living and building (Andersson, 2016).

Most log houses in Sweden are timbered from pine since it contains less coarse twigs and is more resistant against rot. The principle builds on the stacking of logs where the height of the bottom log reaches up to the middle of the next log on top. The logs are normally cut in the bottom to match the underlying log which is called a 'drag' and this method helps create a denser wall with the increasing load of timber and the roof construction. The 'drag' was historically a demanding task and it was not prioritised for all buildings, but today it can easily be performed with a chainsaw.

When building structures are longer than 10-12 meters, the logs need to be joined and this could be done either in the 'knots' or in the middle of the wall (Andersson, 2016). The knots in log houses create the basis for stability and the format

of them has developed over time (Byggnadsvårdsföreningen, 2020). The most rudimentary was the 'överhaksknut', but for buildings that required higher protection from wind drafts the 'dubbelhaksknut' was used. During the 18th century, it grew more common to clad houses in wood panels and the requirement for tight knots therefore became less critical. Smoother-looking knots such as the dovetail joint became more common and the sealment was arranged with a board beneath the paneling.

To keep the logs between the joints in place, dowels are used. These are wooden pegs that fit into holes drilled through the logs. The dowels control the timber and counteract the twisting forces that occur due to twisting, wood growth, and settling in the foundation. The shape of the dowels can be square, polygonal, oval, or round. Normally, the hole for the dowel is drilled straight through the top log and down into at least half of the bottom log (Håkansson, 2002).

In contemporary examples of log houses with insulation involved, three different methods exist for placing the insulation in relation to the timber logs, each resulting in a unique perception of the structure (Junehag, 2020).

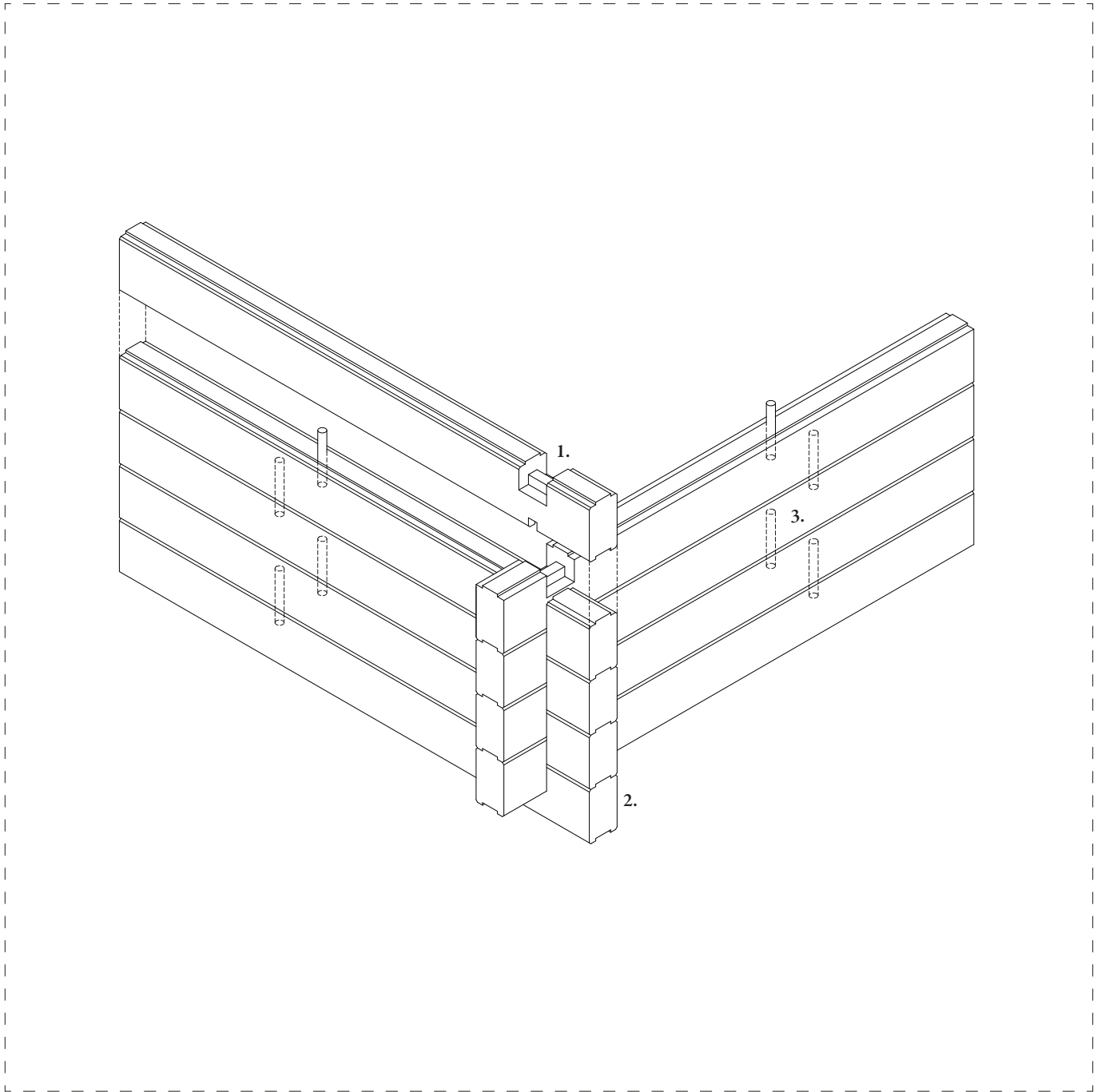

1. 'Överhaksknut'. The knot is formed when two logs interconnect.
2. The beveling at the top and bottom of the log creates the 'sät'.
3. Dowels between logs that help control and stabilize the logs, placed at 1,2-1,8 meters distance and also around openings for windows and doors.



Laxknut



1.



3.

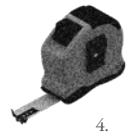

4.

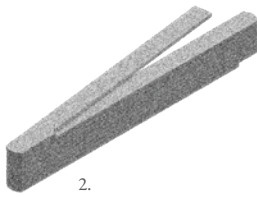

2.



5.

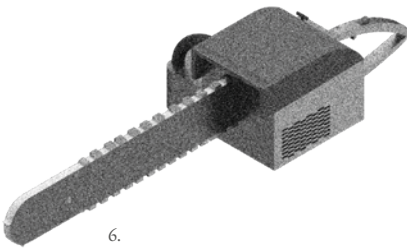

6.



7.



8.



9.

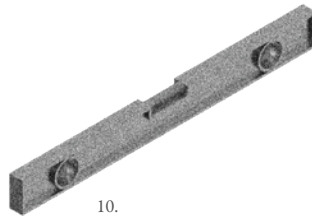

10.



11.

- 1. Axe
- 2. Yardstick
- 3. Gloves
- 4. Tape-measure

- 5. Helmet
- 6. Chainsaw
- 7. Mallet
- 8. File

- 9. Knife
- 10. Level
- 11. Auger

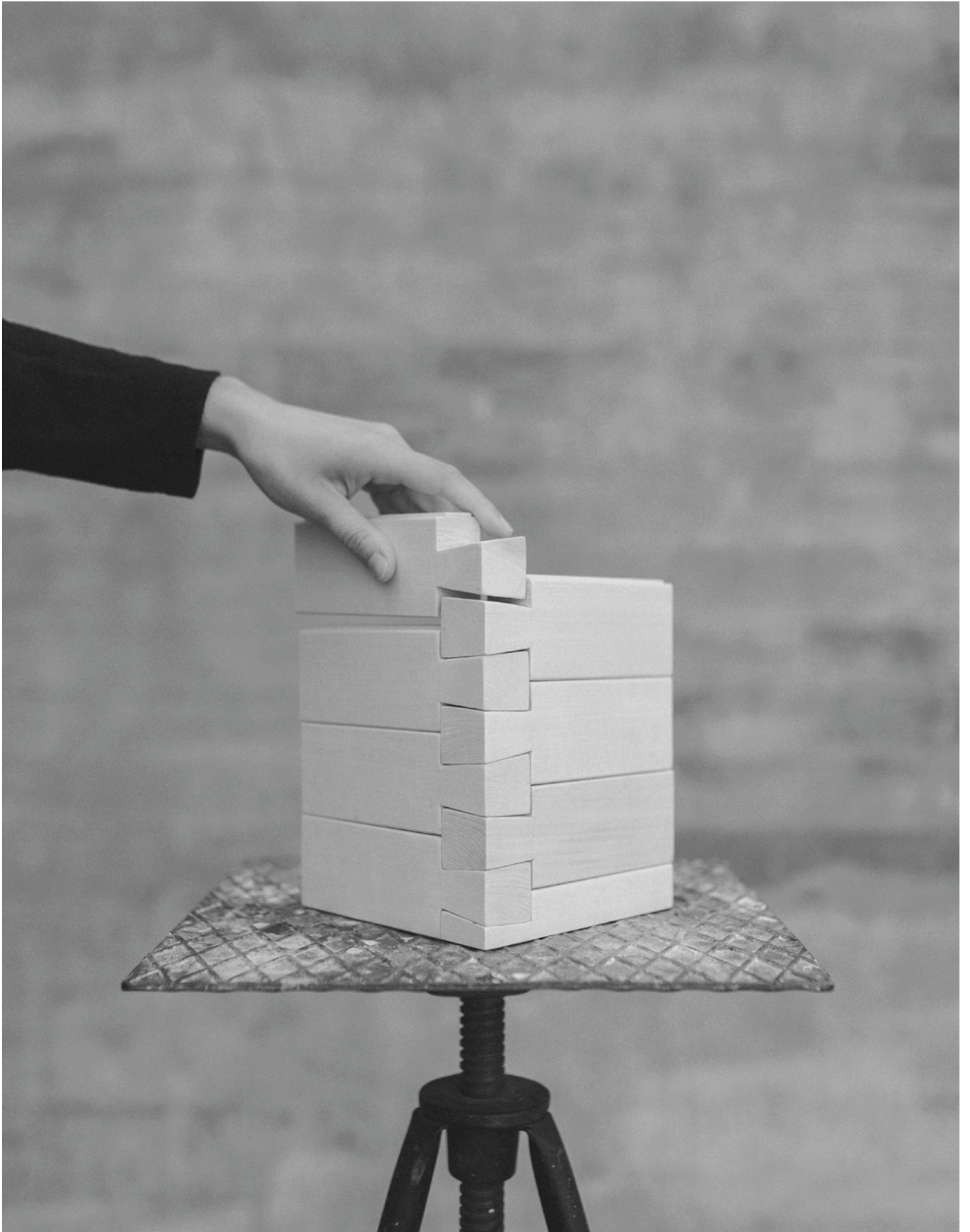

Laxknot

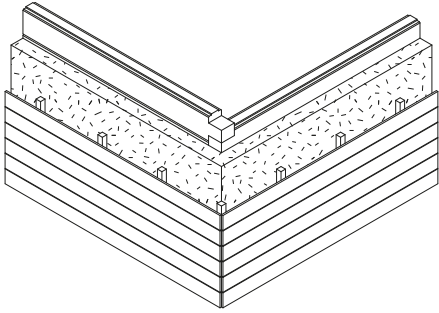

1.

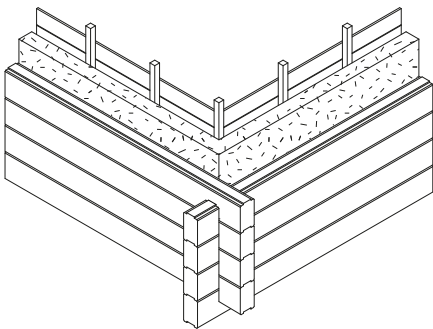

2.

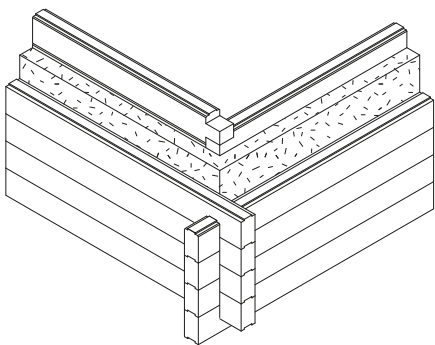

3.

1. Log timber wall with exterior insulation and wood cladding
2. Log timber wall with interior insulation and wood cladding
3. Double log wall with insulation in the middle

When working with existing log timber structures that require added insulation, the most traditional way has been to add the insulation on the exterior with wood panels on top (illustration 1.), creating a facade which protects the logs and showcases the logs on the inside.

Contrary to this method, insulation can be added on the interior (illustration 2.), creating a facade which displays the logs externally and is clad on the inside. This creates a robust structure which displays the bearing principle on the exterior and has a more refined and sleek interior.

Lastly, the double log wall has insulation in between two log walls (illustration 3.). This technique creates a more robust atmosphere and showcases the log construction principle both inside and outside. However, this technique requires more building material making it more costly and demanding.

KLÖVSJÖ SKI VILLAGE

Today

The ski village is located about four kilometers South of the old village and connects with the ski system of Storhogna to the West. Adjacent to Svartåstjärnen lies Hotel Klövsjöfjäll, which provides traditional hotel rooms and apartments but has a primary focus on larger companies and conference guests. Atop the ski slope stands a recently expanded café, offering lunch and accommodating 'fika'-guests throughout the day.

Over recent years, the ski village has gone through substantial growth, marked notably by the development of numerous private ski cabins. The housing supply is characterized by two distinct categories: the conventional hotel with a more commercial atmosphere, and the freestanding cabins, which prioritize privacy but place less emphasis on communal activities and gatherings. Similarly, the dining options are divided into two groups, the hotel at one end with the larger space accommodating many guests, and the smaller cafés focused more on the daytime ski guests.

In summary, the ski village is evidently in a phase of ongoing development. With appropriate additions it holds the promise of evolving into a place with a more distinct identity, offering a diverse and intimate experience reminiscent of the atmosphere found in Klövsjö village.

Design implementation

The project site is situated on the West shoreline of Svartåstjärnen in close relation to the water and pine forest. This is a transitional place between the more public area of the ski village with ski lifts and hotel to the North and the private housing area in South.

The location and program aims to fill the gap between the privatized cabins and the public hotel, also creating a place which strikes a balance in scale between the scattered and the grand. This has shaped the program of a public building in the form of a medium-sized restaurant and dwelling units with a shared sauna that are arranged around a courtyard offering a space for semi-public gatherings.

The site is situated on a smooth slope and is surrounded by forest, water and a couple of private cabins. The existing path through the plot creates a sightline through the pine trees towards the water.

- | | |
|------------------------------|------------------|
| 1. Main ski lift | 5. Parking lot |
| 2. Cross-country skii tracks | 6. Parking lot |
| 3. Svartåstjärnen | 7. Mountain café |
| 4. Hotel and conference | |

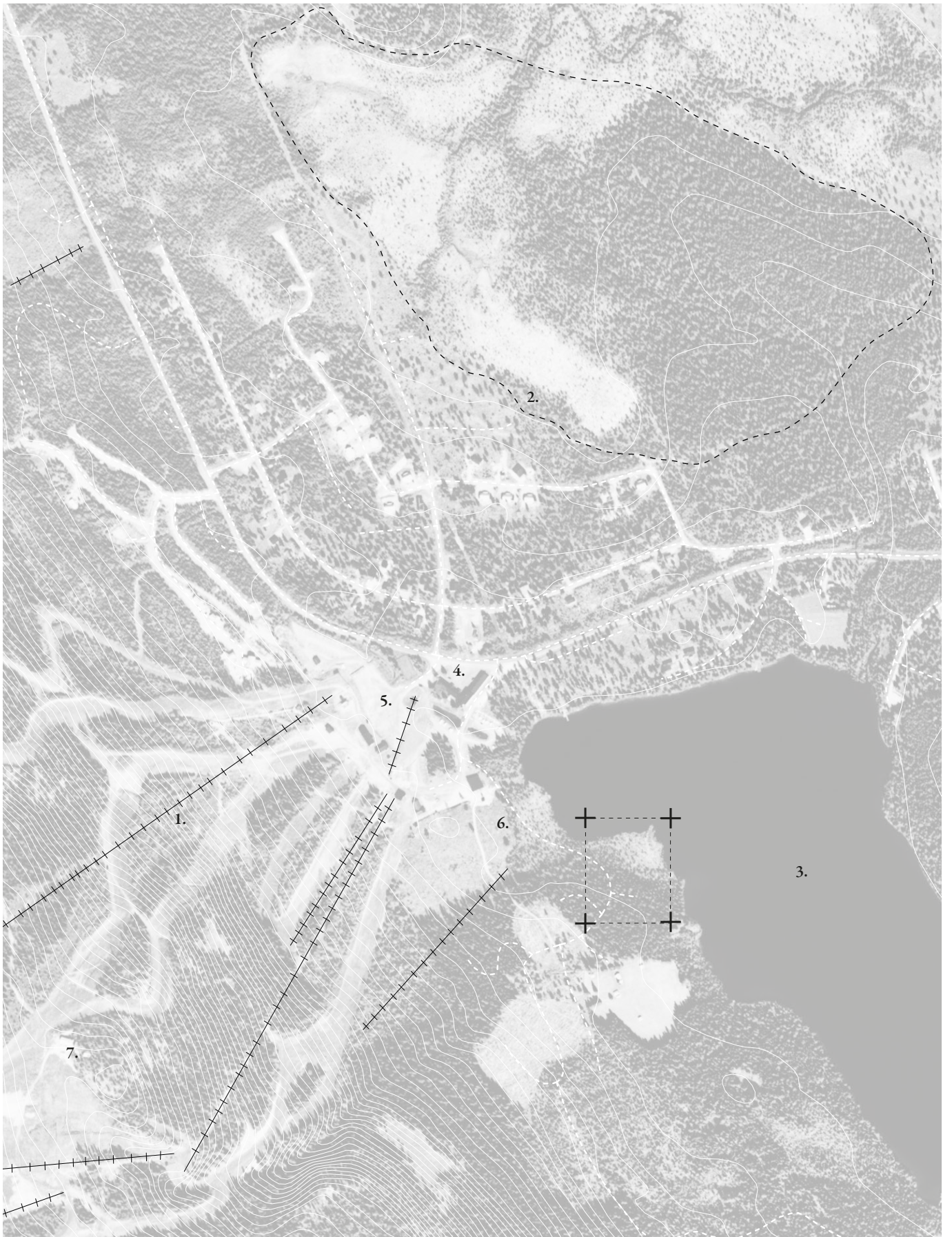

View over project site from South





III.

Design proposal

PROJECT SITE

The project site is part of the ski village, connected to both the public area and the more private housing area. The topography is gentle in comparison to the surroundings and what characterizes the place is the serene forest setting with a visual connection with the small lake Svartåstjärnen.

The restaurant is situated closest to the ski village centre and adjacent to the outer lift in the ski system. It serves as the final public building before entering the local road lined with private cabins. Positioned in this transitional location, the restaurant maintains a modest scale and form in order to create an intimate and personal atmosphere. This is a place where guests can enjoy a good meal while feeling embraced by the surrounding forest.

The dwellings are located further up the road and are oriented with their entrances around an existing road and their social spaces toward the surrounding forest. The arrangement of buildings creates a courtyard which draws inspiration from the historic enclosed structures characteristic for Klövsjö. Similar to the village courtyards, this space acts as a focal point for gatherings and the paths connecting the lodgings.

Down the local path, amidst the pine forest and overlooking the water, sits the shared sauna. Initially appearing as a singular entity, it is in fact divided into two units beneath a shared roof. The building consists of changing rooms, lounge areas and a sauna.

While the buildings serve different purposes, the aim is to establish a harmony among them through shared materiality and form, consequently weaving together the area. At first glance, the buildings may appear identical, featuring timber construction with smooth dovetail joints and displaying the same materials for base, wall and roof. However, subtle distinctions in detailing reflect the differing functions of each building. For instance, the restaurant, as a public space, employs a more intricate and costly log timber technique that emits a sturdier atmosphere while the lodgings and sauna are constructed using lighter techniques, resulting in sleeker interiors.



- 1. Restaurant
- 2. Dwelling units

- 3. Sauna
- 4. Outdoor fire pit

Site plan
1:800



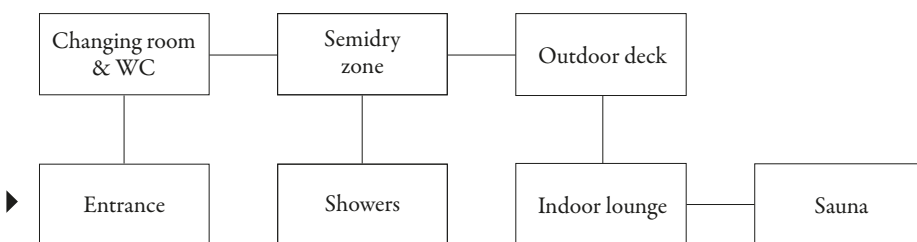
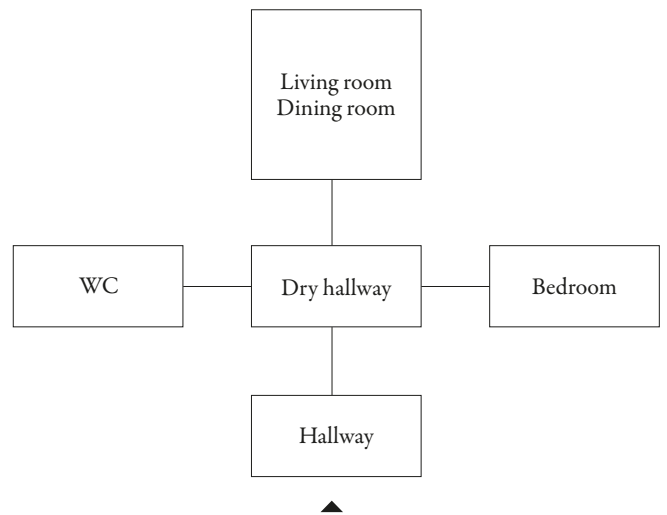
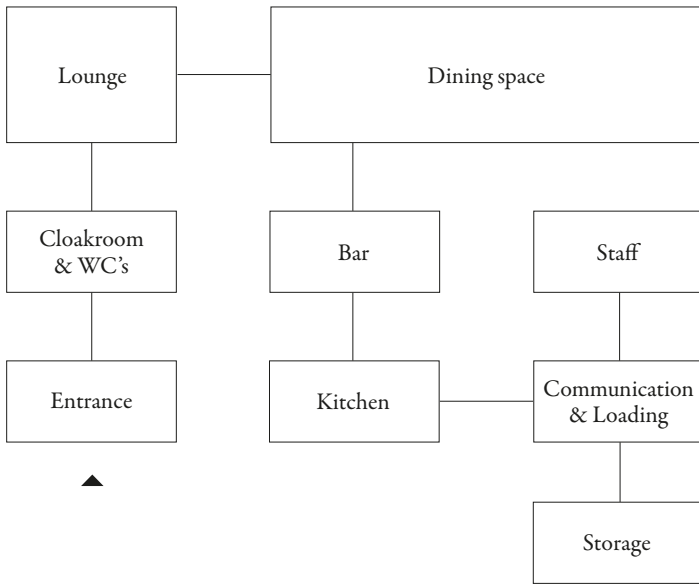

1. Restaurant

Cloakroom	14 m ²
WC's	20 m ²
Restaurant	105 m ²
Bar	10 m ²
Kitchen	18 m ²
Storage	5 m ²
Cold storage	5 m ²
Loading and communication	8 m ²
Garbage room	5 m ²
Technique room	3 m ²
Staff	10 m ²
Total	203 m²

2. Dwelling

Hallway	4 m ²
Dry hallway	3 m ²
WC	5 m ²
Bedroom	5 m ²
Living room	28 m ²
Loft	18 m ²
Total	63 m²

3. Sauna

Entrance	3 m ²
Changing room and WC	8 m ²
Showers	9 m ²
Outdoor deck	13 m ²
Indoor lounge	9 m ²
Sauna	11 m ²
Total	53 m²





RESTAURANT

Approaching the restaurant, it reads as a more introverted and modest building with an indentation in the long front facade hinting the main entrance. You enter through the cloakroom and bathrooms with a sightline through the fireplace in the dining space. The fireplace becomes a focal point from several points in the building and also acts as a divider of the larger open space. On one side is the more informal lounge and on the other are the dining tables and bar.

In contrast to the anonymous and enveloping entrance, the dining space opens up with large window openings connecting the interior with the exterior forest, creating a sense of being enveloped by the surroundings.

The building is spatially split in half with the social spaces in one and practical functions such as kitchen, storage, bathrooms and loading in the other, which also gives rise to the two contrasting long facades.

The construction technique used is the double log timber wall, with semi-visible roof rafters resting on a roof ridge. The double log wall exposes the stacked logs on both sides which emits a robust atmosphere in both exterior and interior.

The polished concrete floors connect create a sleek finish to the floors and reflect the light seeping in through the windows also creating contrast to the warm tones of the wood walls and furnishing. The visible roof rafters create a spacing and rhythm to the long spatialty of the dining space.

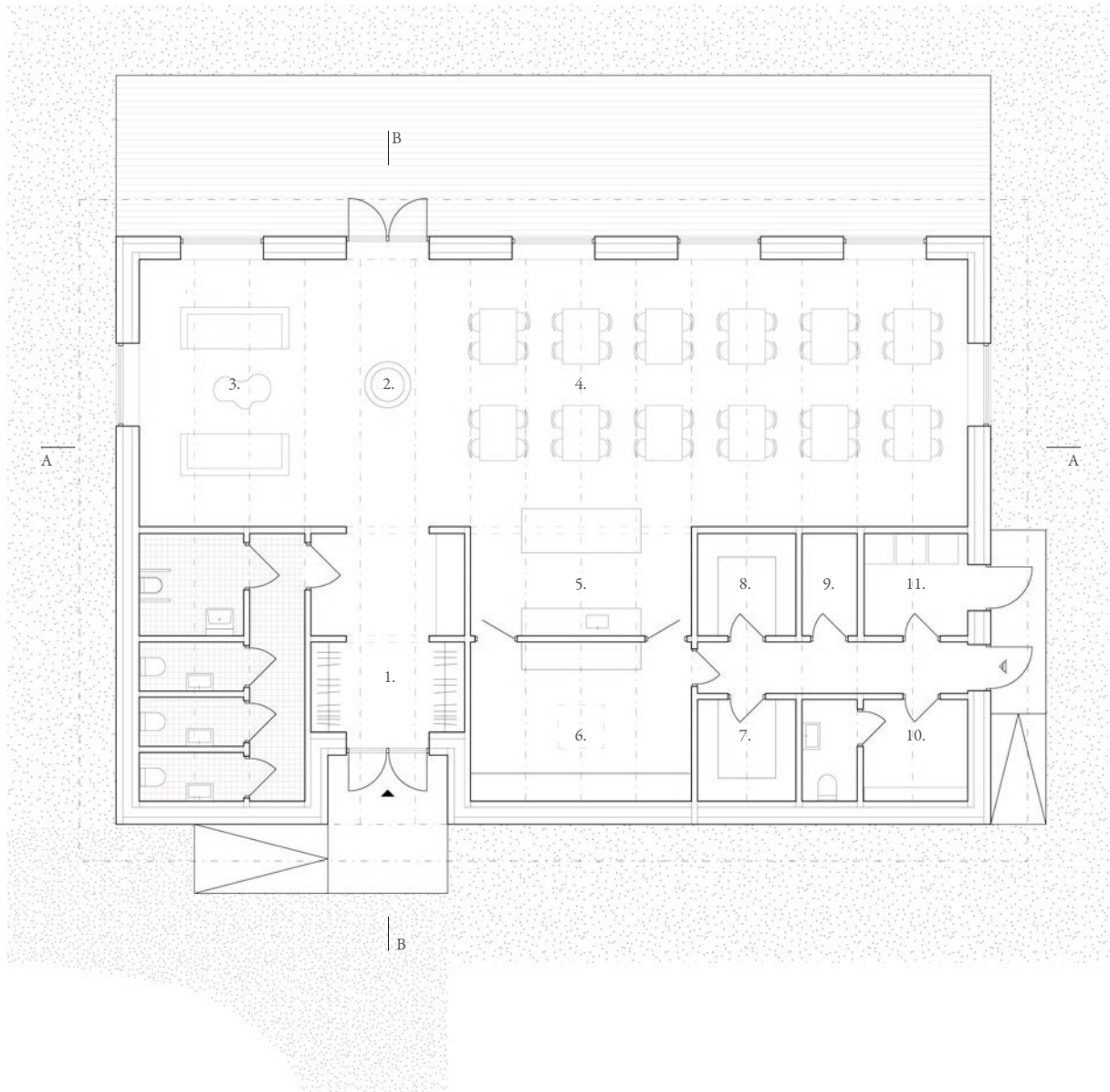

- | | |
|-----------------------|------------------|
| 1. Cloakroom and WC's | 7. Storage |
| 2. Open fireplace | 8. Cold storage |
| 3. Lounge | 9. Technology |
| 4. Dining space | 10. Staff |
| 5. Bar | 11. Garbage room |
| 6. Kitchen | |

Floor plan
1:150





Restaurant entrance

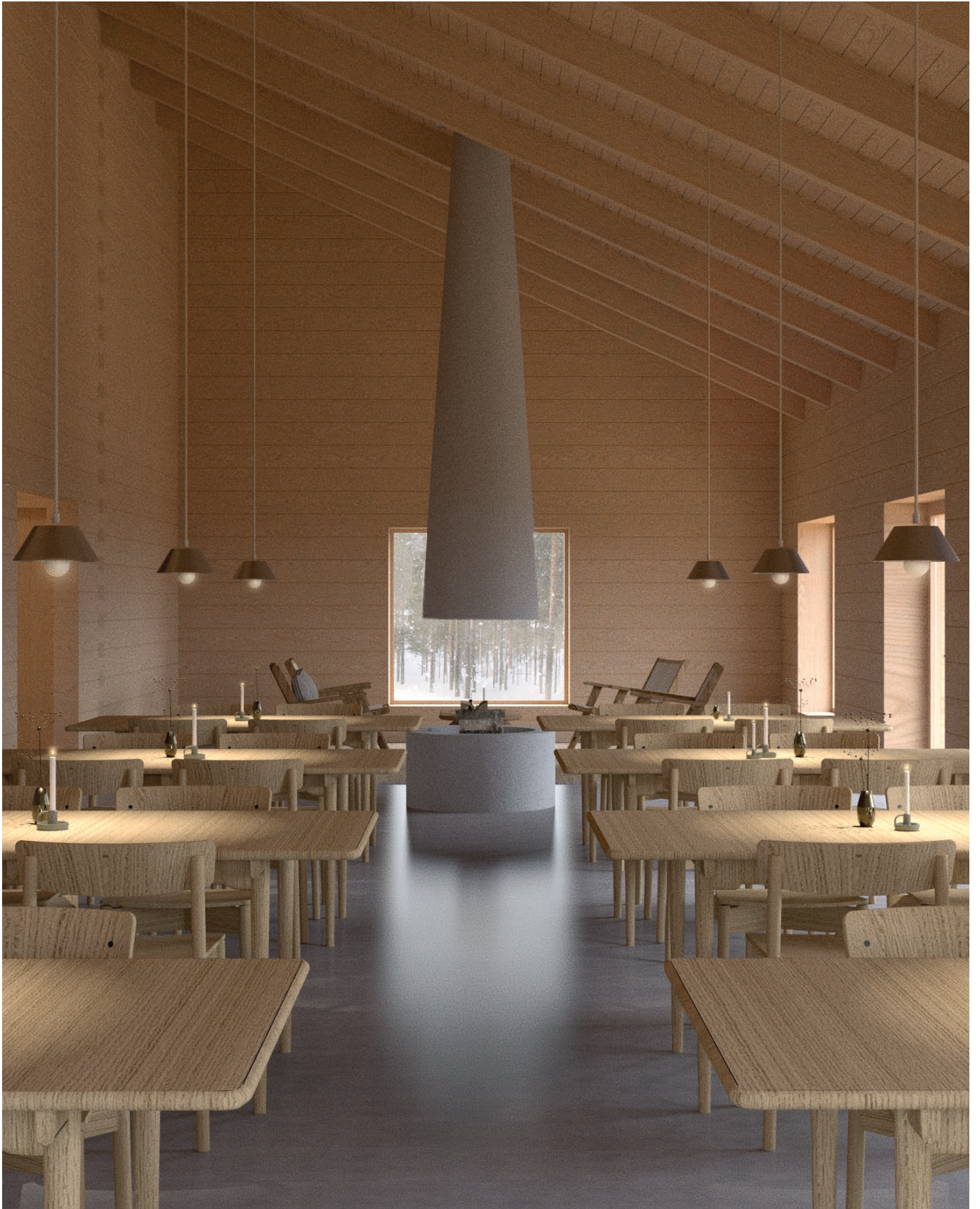

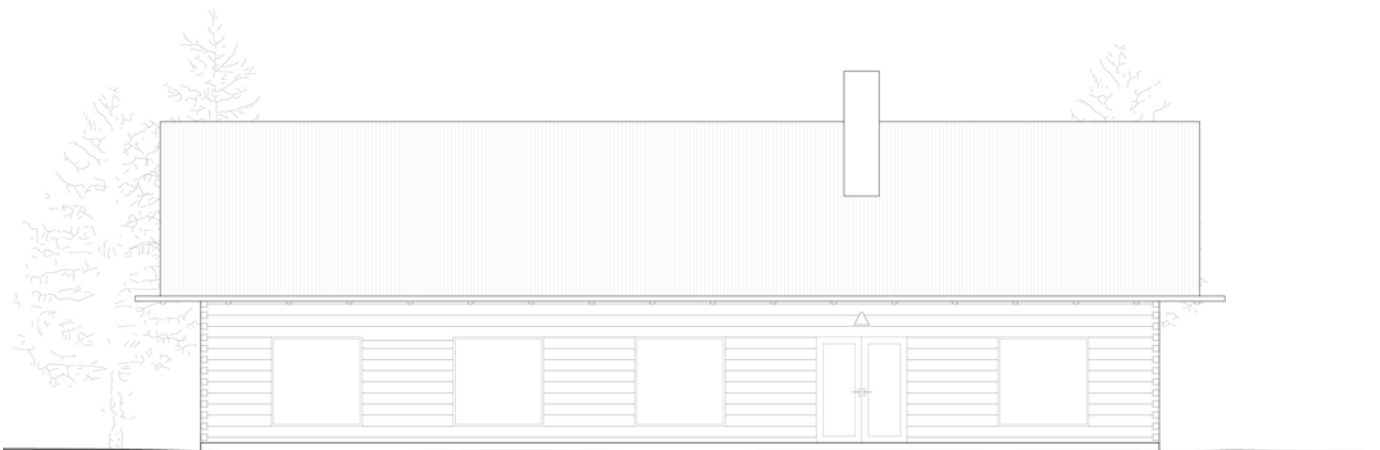







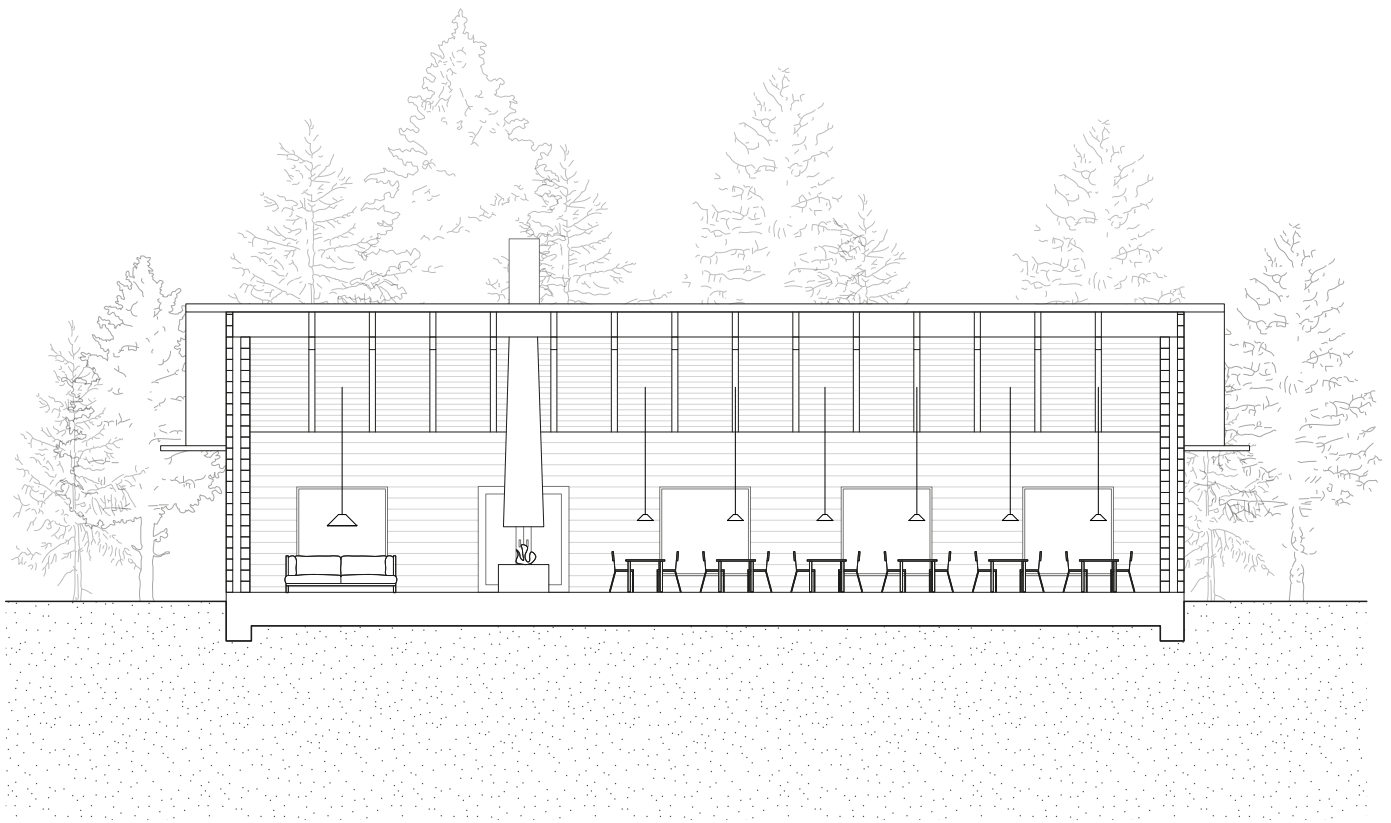

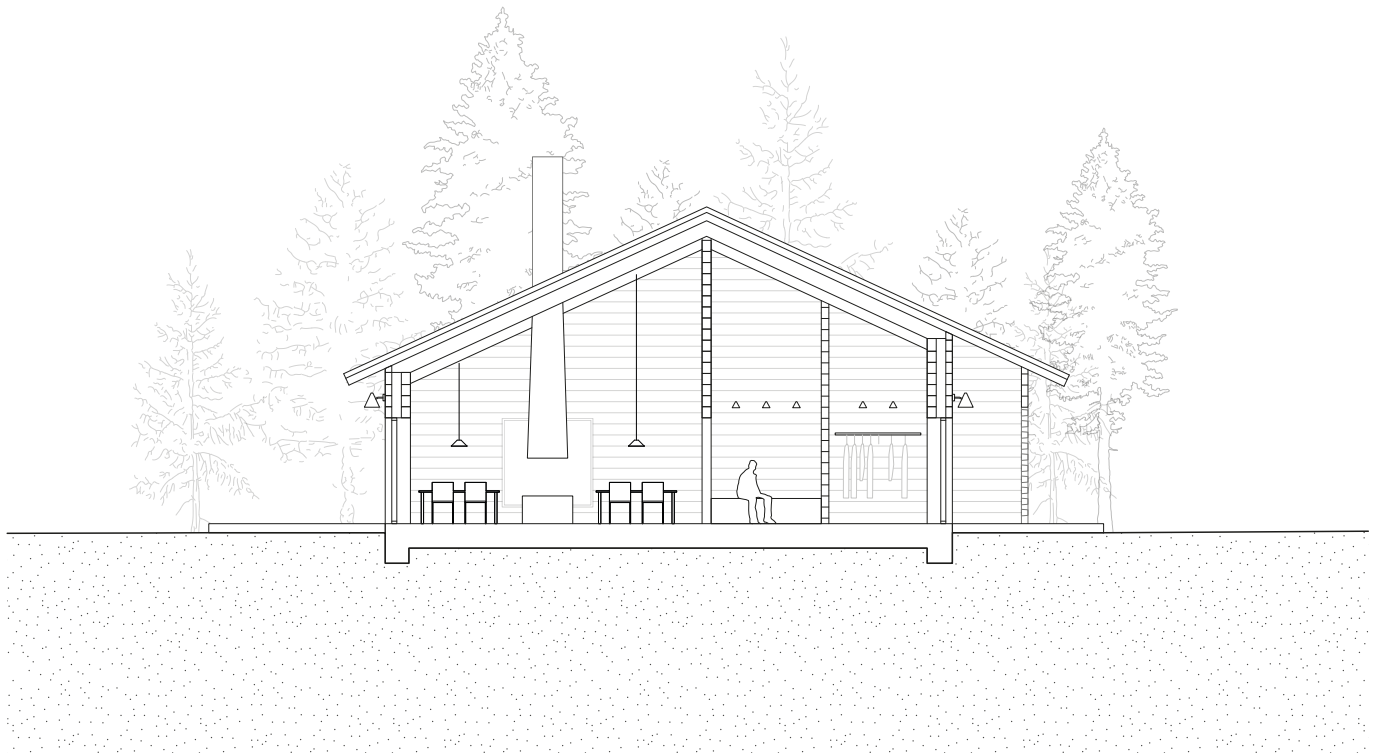





**1. Roof**

Corrugated metal sheet roof
 Roofing felt
 Roof decking (22 mm)
 Batten cc 1200/Ventilated cavity (95 mm)
 Board (15 mm)
 Roof rafter cc 1200 (450 mm)
 /Insulation (250 mm)
 Vapour barrier
 Wood panel (22 mm)

2. Wall

Timber log (130x220 mm)
 Insulation (160 mm)
 Diffusion open vapour barrier
 Timber log (180x220 mm)

3. Base

Fibre covering
 Macadam
 Insulation (300 mm)
 Concrete (170 mm)
 Polished concrete (40 mm)

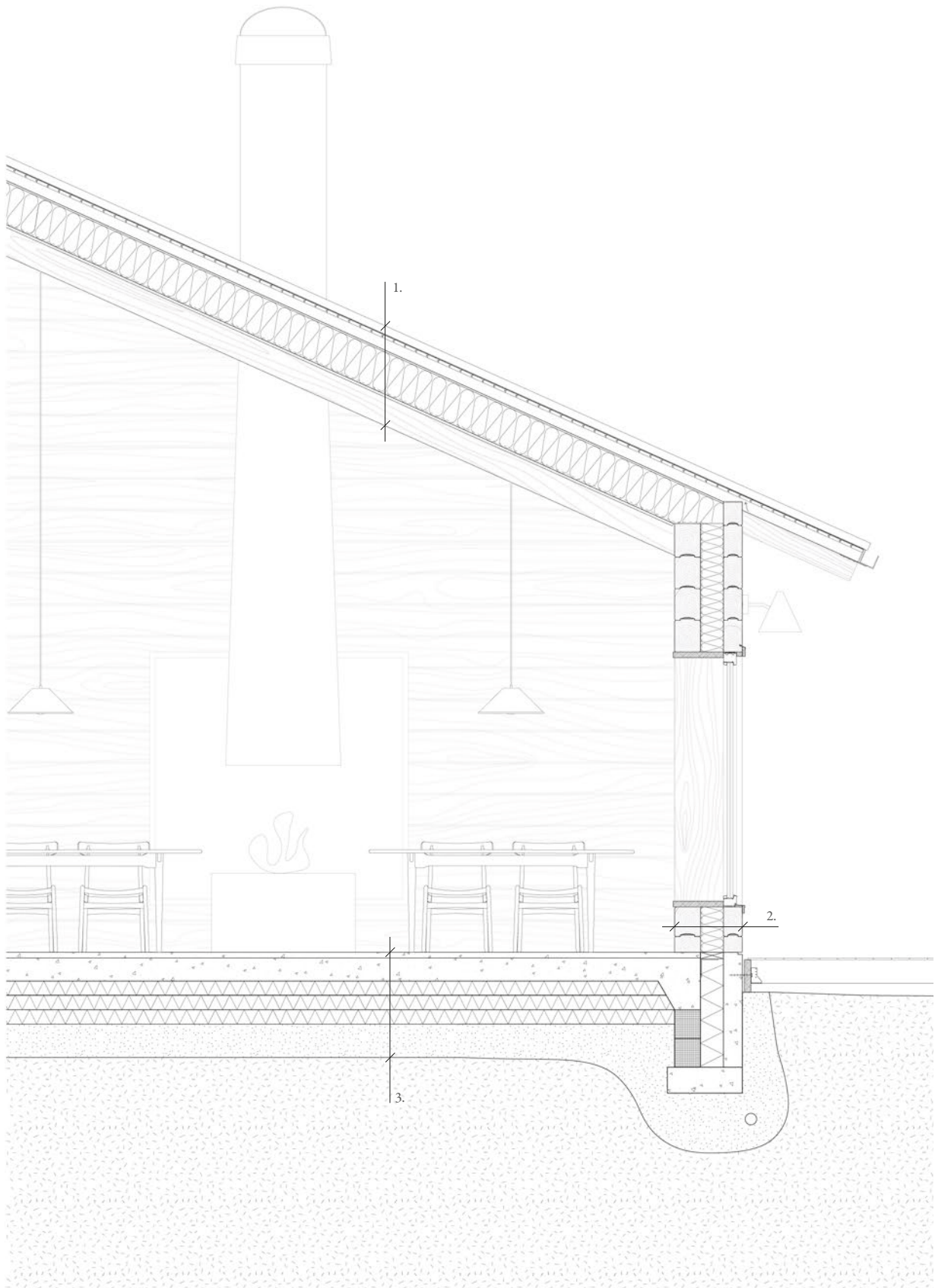

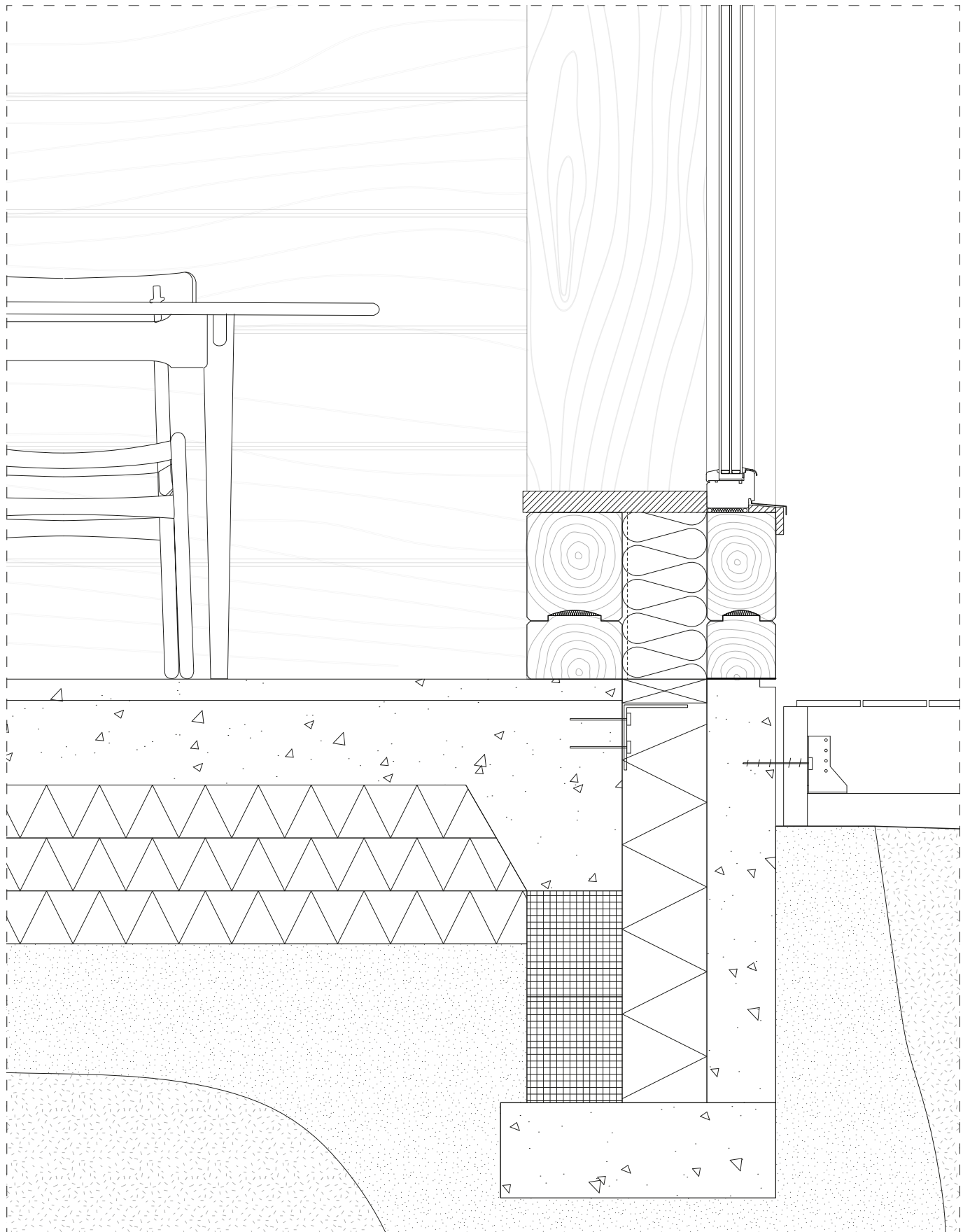

Base detail
1:10

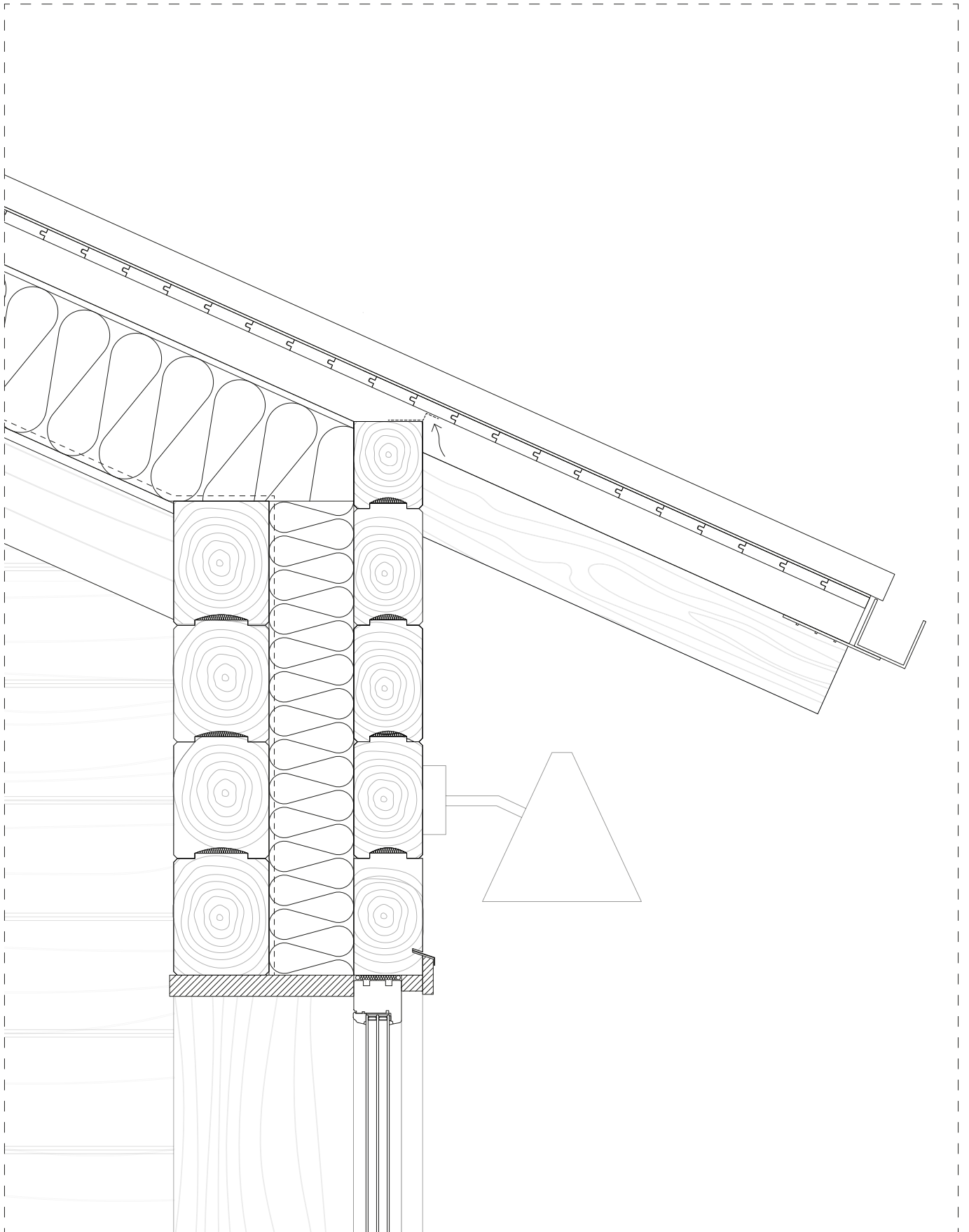

Roof detail
1:10

DWELLINGS

The concept of the dwellings is based on the idea of the standard ski cabin which is compact and fits the essentials for a mountain stay. Above the entrance door is a secondary roof of a thin aluminium sheet resting on L-profiles attached to the wall. This gesture frames the entrance similar to the traditional "farstukvist" with a modern and more lightweight touch.

As you enter the dwelling, the fireplace in the living room becomes the focal point, which also divides the living room and dining space. The division of the hallway, emphasized through the wall protrusions as well as the different flooring, creates one entrance zone for wet clothes and shoes, and one dry zone for communication between the different rooms.

Window openings in the open social space are different sizes in accordance with the function in the interior. The living room window reaches further down to create a window seat across from the fireplace and clear views from the sofa.

The window along the dining table is positioned more in line with the table height which creates a backrest for the seating bench.

The construction method used for the dwellings is a simple log timber wall with insulation and wood panel cladding on the inside. This creates a refined and sleek finish to the interior walls, and gives the possibility to conceal installations behind the interior cladding. The interior log walls carry the load of the loft but are not interconnected with the exterior walls in the conventional log timber way. Instead they are attached with mounts behind the cladding and insulation. They are therefore not visible as knots in the exterior, which also reduces amount of points for cold bridges.

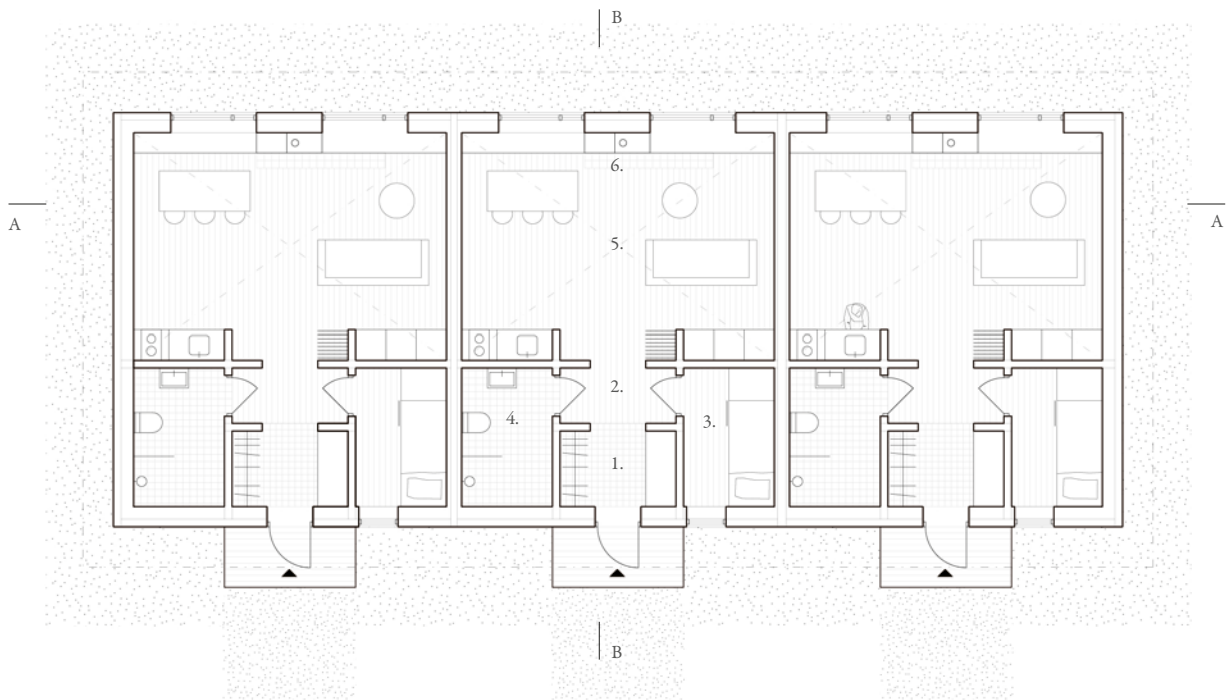

- 1. Hallway
- 2. Dry hallway
- 3. Bedroom with bunk bed
- 4. WC
- 5. Pentry and living room
- 6. Fireplace

First floor plan
1:150





View of fireplace from the hallway

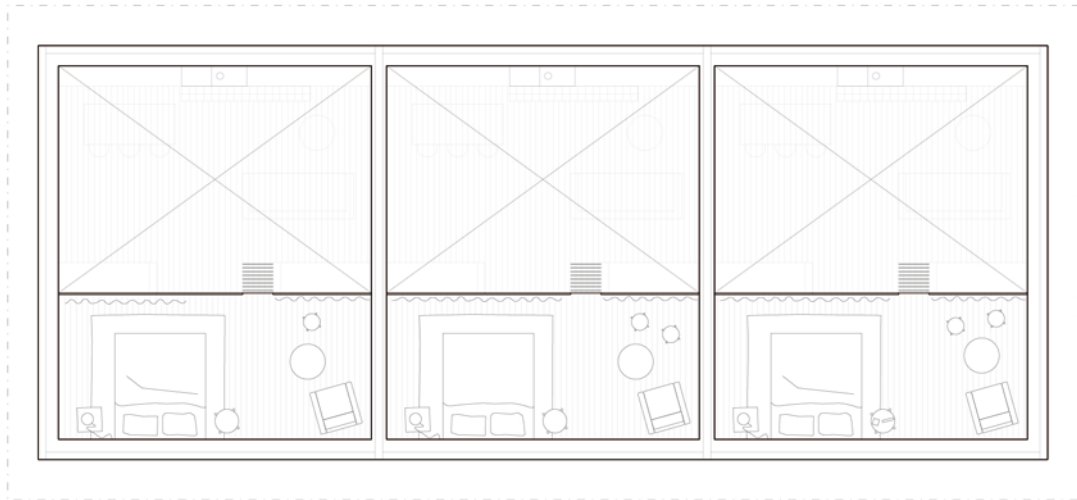

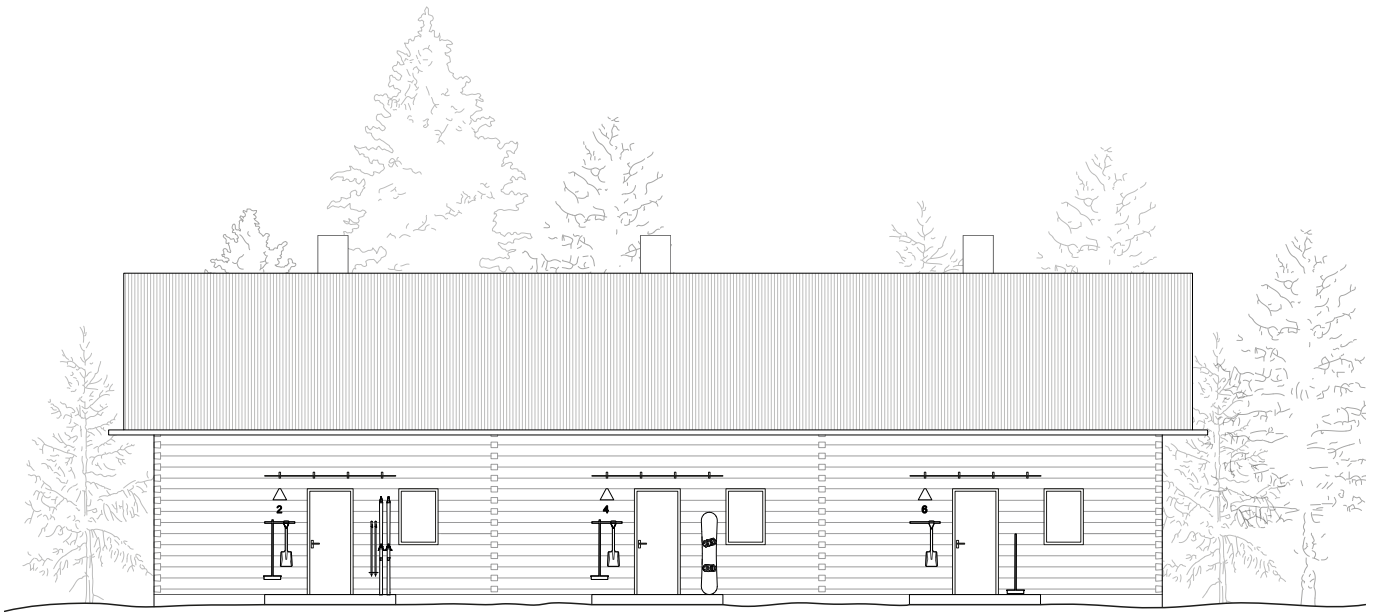

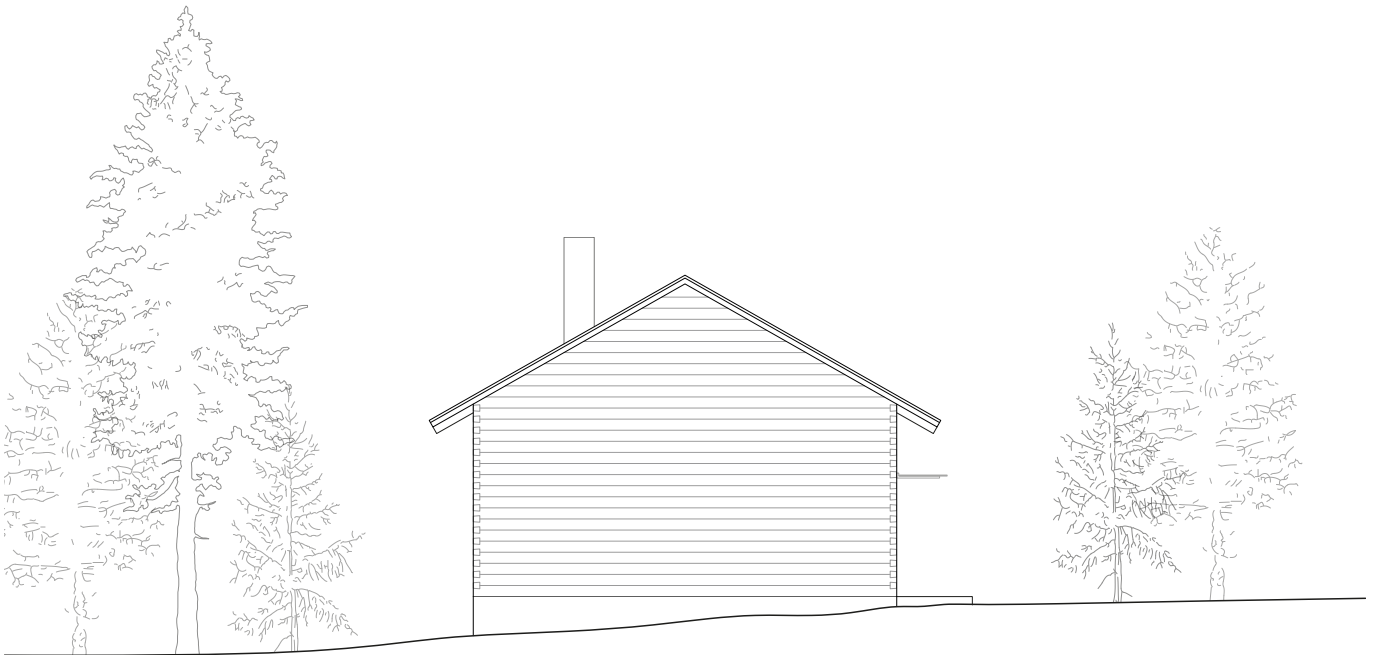

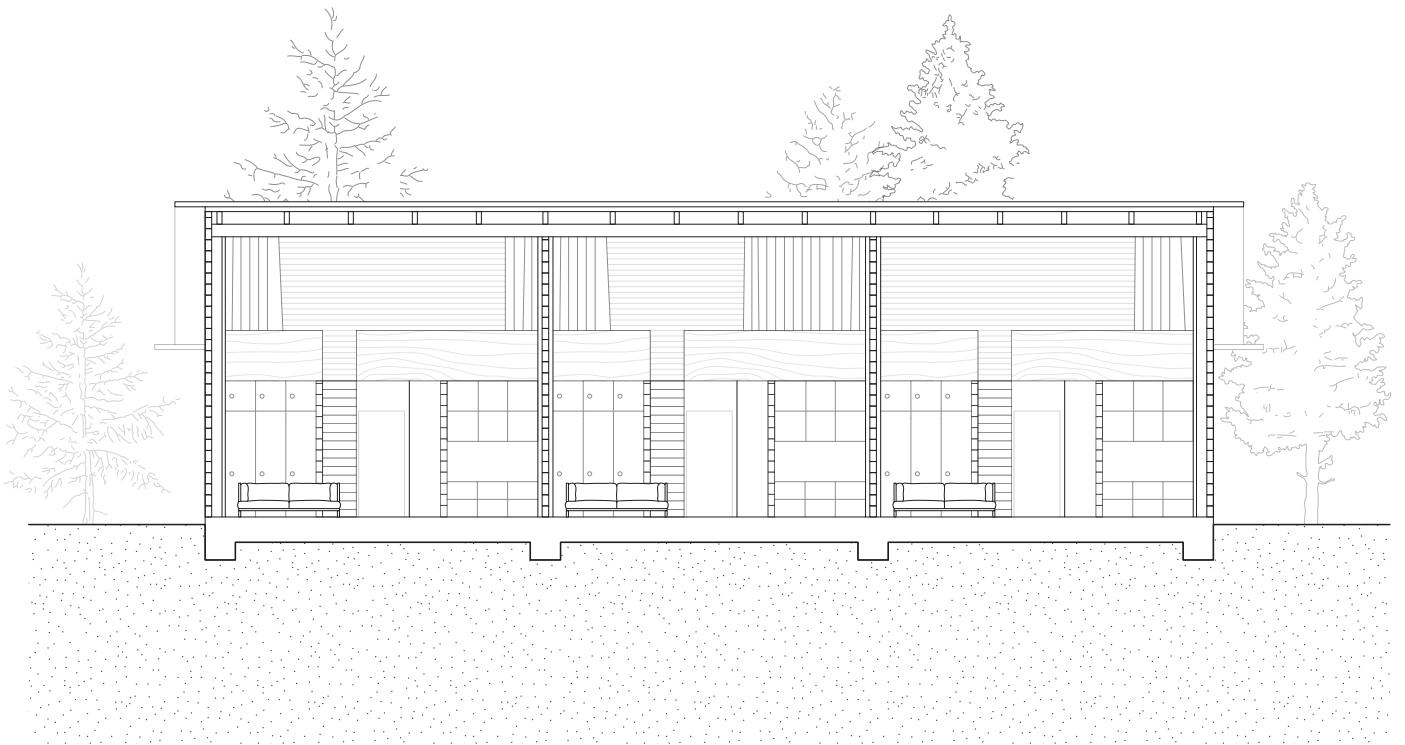





Living room window

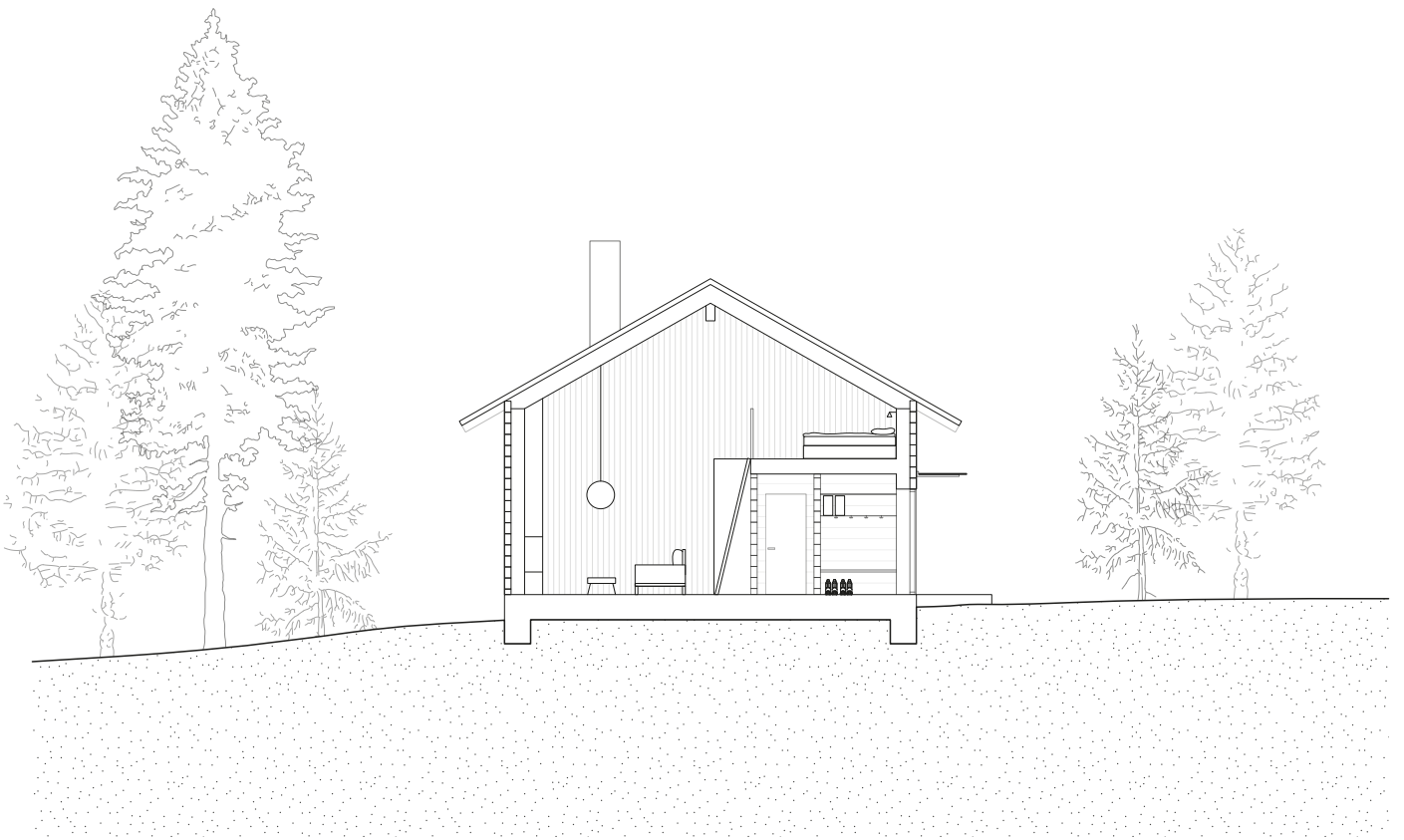

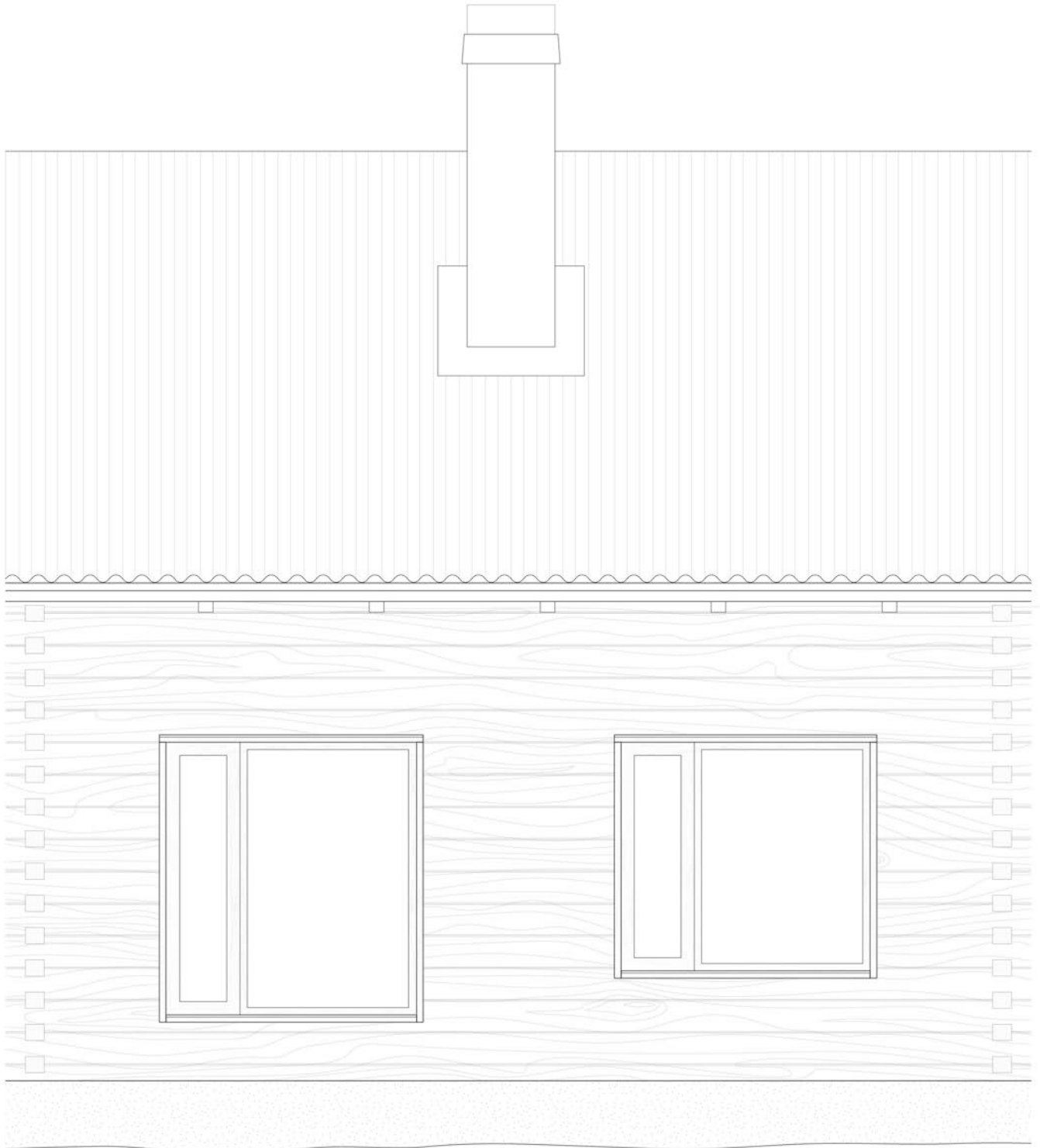
**1. Roof**

Corrugated metal sheet roof
 Roofing felt
 Roof decking (22 mm)
 Batten cc 1200
 /Ventilated cavity (95 mm)
 Board (12 mm)
 Roof rafter cc 1200
 /Insulation (350 mm)
 Vapour barrier
 Wood panel (22 mm)

2. Wall

Timber log (130x220 mm)
 Insulation (120 mm)
 Diffusion open vapour barrier
 Insulation / Installation layer (70 mm)
 OSB board (11 mm)
 Wood panel (22 mm)

3. Base

Fibre covering
 Macadam insulation (300 mm)
 Concrete with floor heating (200 mm)
 Vapour barrier
 Board
 Floor boards

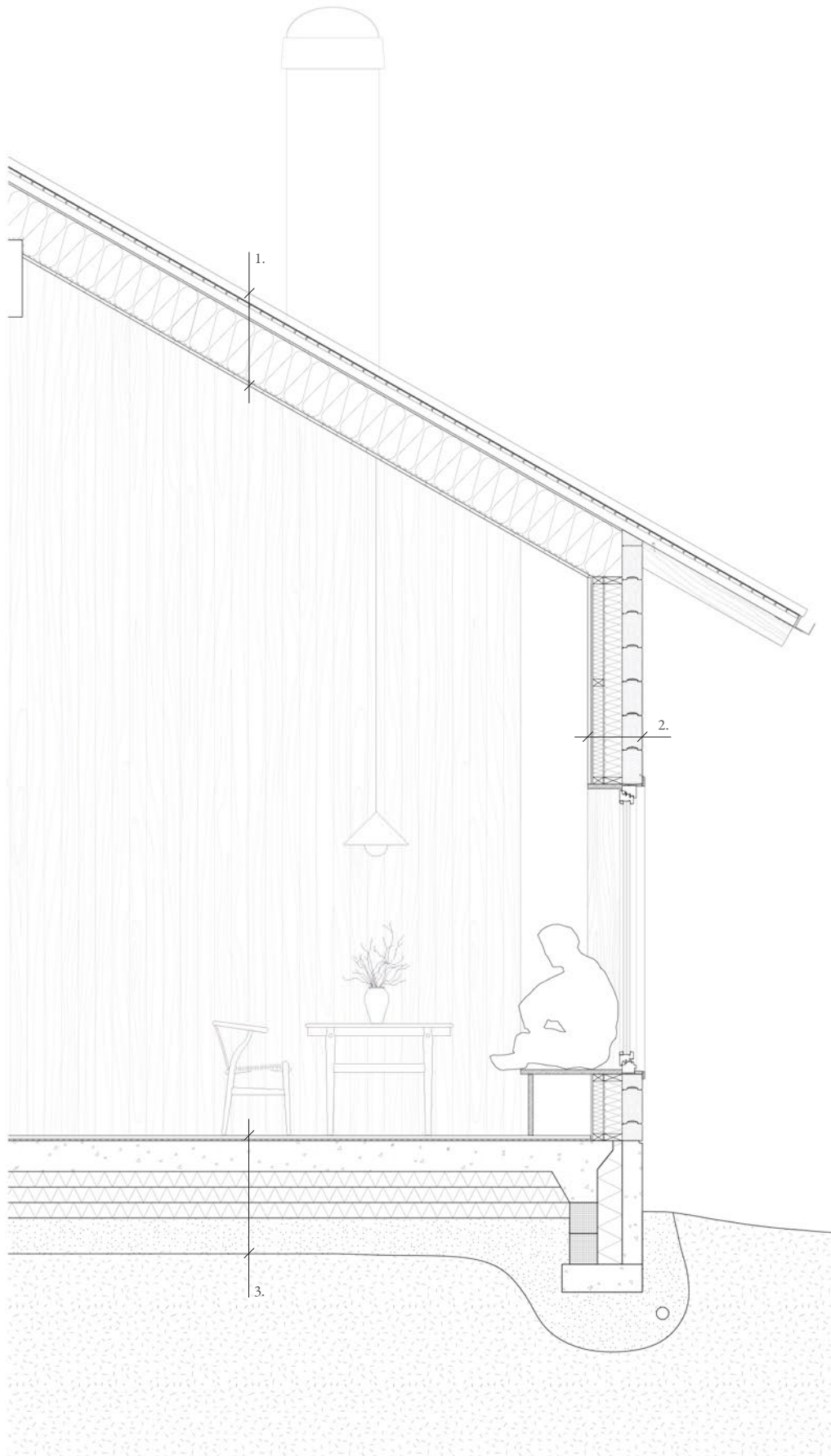



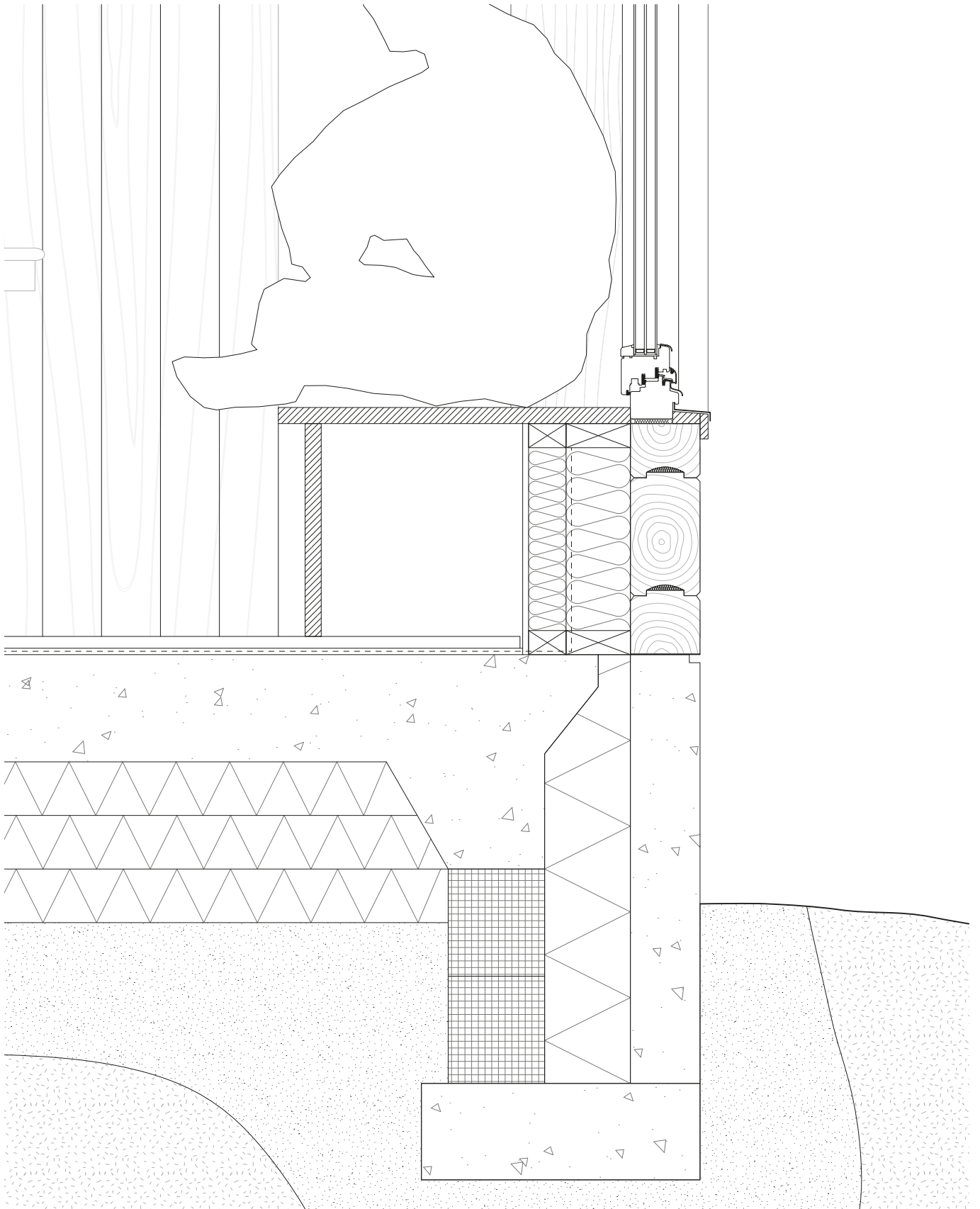

Window seat detail
1:10



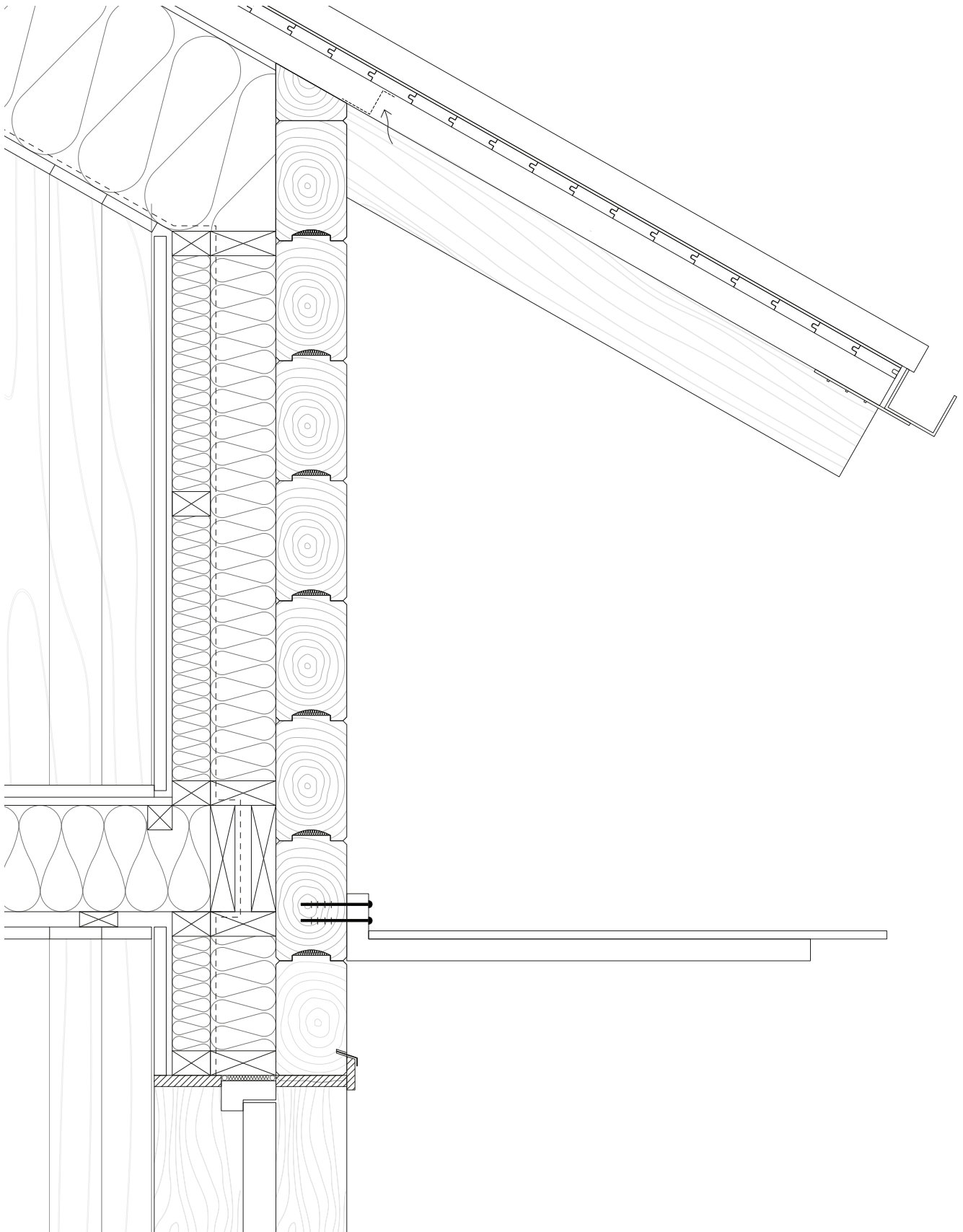

Roof detail
1:10

SAUNA

The sauna is situated in close connection to the water and in a more secluded part of the forest. Initially appearing as a singular entity, it is in fact divided into two units beneath a shared roof.

The first unit comprises the entrance room, changing room, bathroom and showers. The second volume is dedicated to the ritual of sauna bathing with a darker more introverted lounge room and a sauna overlooking the forest and water. Between the two units lies an outdoor patio, which serves as a cooling area between sauna sessions.

The structure features a single log wall with interior insulation and cladding. Like the dwelling units, the windows are positioned at varying heights according to the interior functions. Similar to the dwelling units, the window openings are placed in different heights according to the functions on the inside.

The shower and changing rooms have windows placed close to head height to increase privacy, while the openings in the lounge and sauna are placed in line with the different seating heights.

The sauna is a place where visitors can either begin or conclude their days, enjoying the privacy of the tranquil forest surroundings and lake.

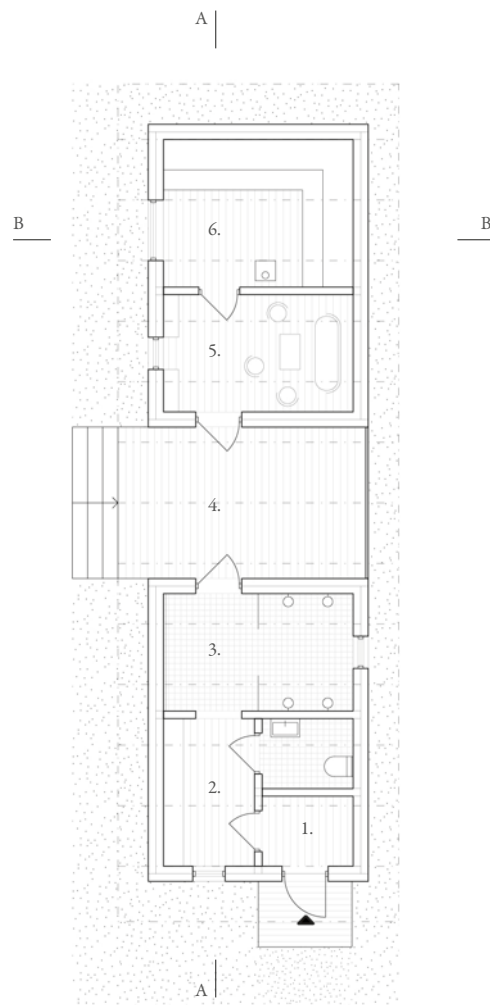

- 1. Entrance
- 2. Changing room
- 3. Showers

- 4. Outdoor deck
- 5. Indoor lounge
- 6. Sauna



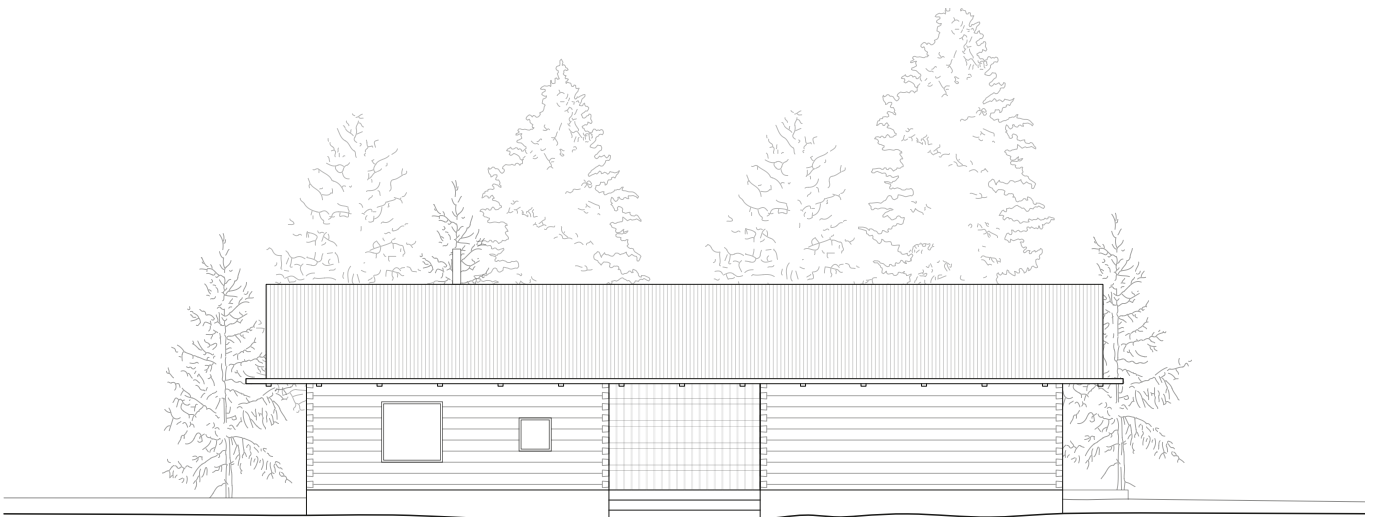
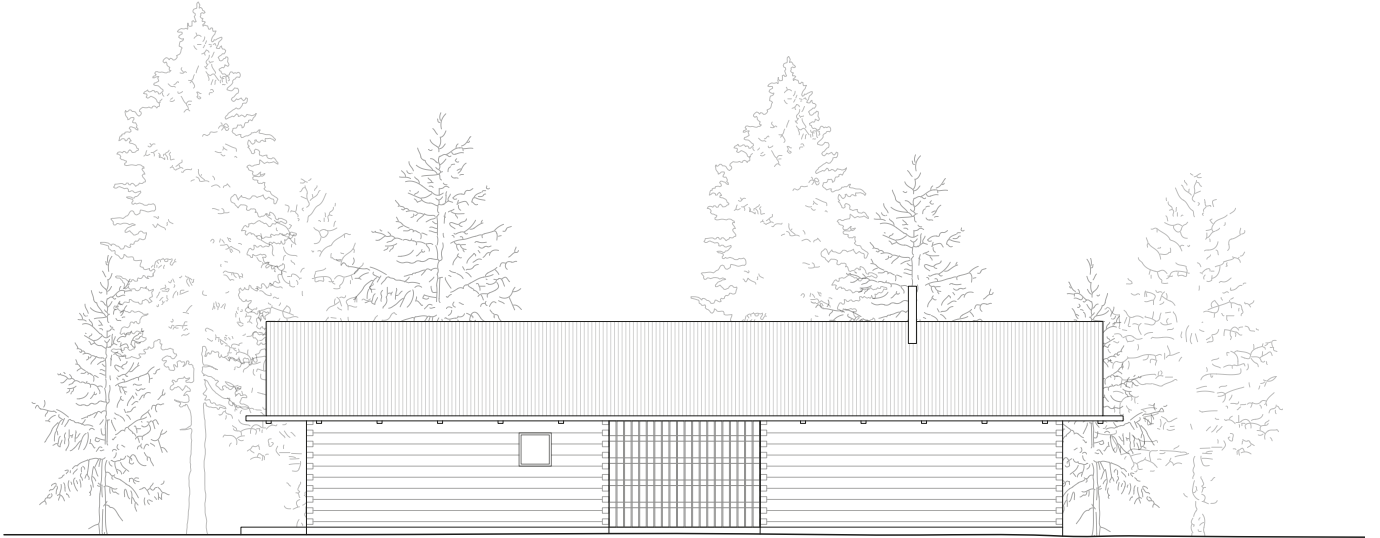







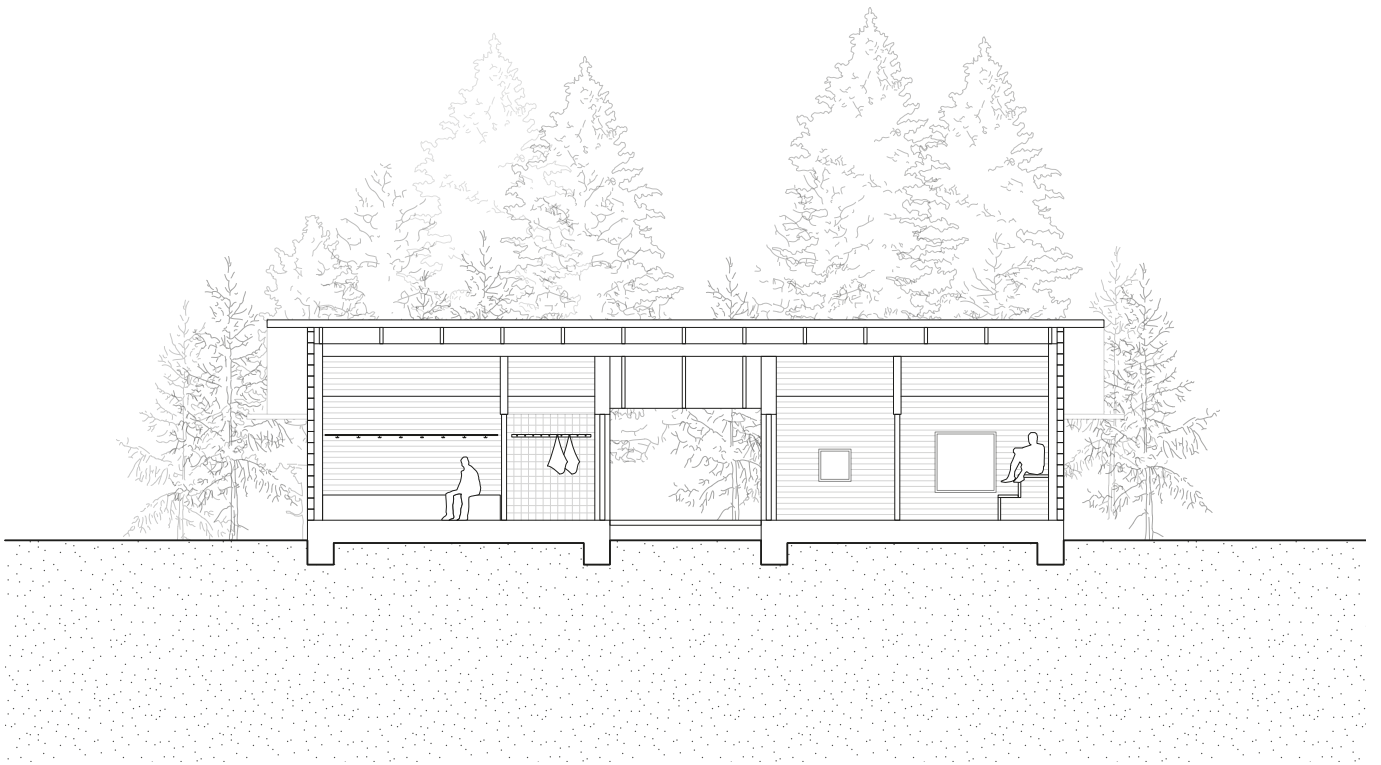

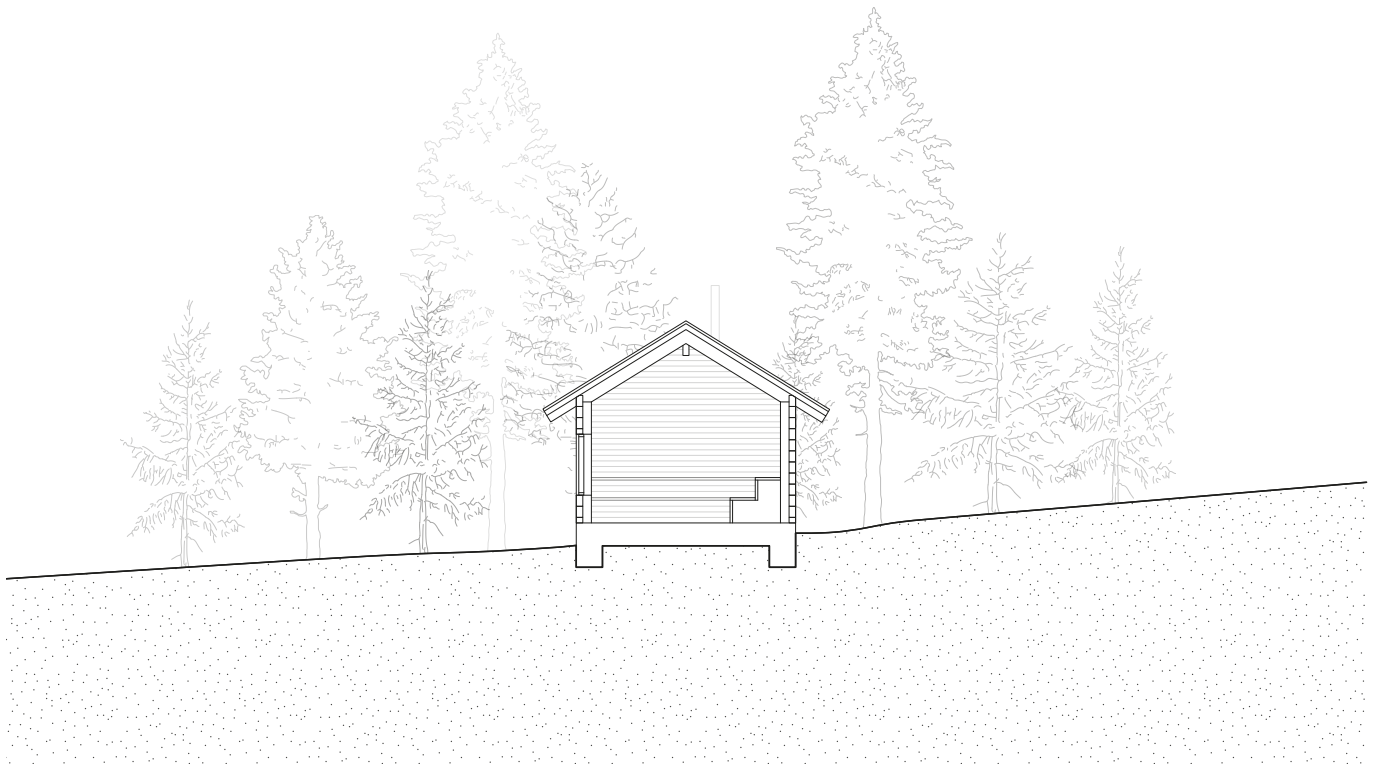

IV.

Conclusion

DISCUSSION

This thesis project began from a personal connection rooted in growing up in the mountain areas of Jämtland which are environments that hold sentimental value not only to me but more importantly for the local residents and many other people nationwide. However, through the development of ski resorts as a consequence of attempting to meet this high demand, the distinctive character of surrounding villages has gradually eroded, often been replaced by a homogenized portrayal of mountain resorts. This is a loss both for the local communities as well as the visitors who do not get to experience the essence of the place.

Working with this thesis has revealed the complexity of navigating through the concept of identity. Texts touching on the subject are broad in their description and built references work with their local context in different ways from project to project. The conclusion being that identity is a highly plastic concept, not restricted to neither tangible or intangible aspects, and rather is a combination of both.

The design proposal for this thesis is therefore derived not only from the theoretical framework but also significantly from own perceptions and reflections while visiting the site throughout the year. However, this reliance on personal experience also establishes the limitations of the study, as it becomes inherently subjective.

Critically reflecting on the chosen method and design approach; the thesis formed a clear intention early on in the process to focus on the observed traditional building techniques and the detailing of it, rather than the social aspects of the subject of mountain tourism as a whole. Therefore the methodology could have been differently formulated if the focus would have been on a different target group.

Studying log timber construction, both its historical roots and contemporary applications, has been instrumental in informing the design implementation. While the fundamental principles of this method have influenced the rational structures of the project, there is also a deliberate effort to avoid letting tradition constrain the design. Instead, the project has sought to push the boundaries of traditional techniques and aesthetics. Although log construction is an old technique it is still to this day a compelling one due to its simplicity and reliance on a certain craftsmanship.

Contemplating the importance of the thesis question, the final reflection is that with the presumed development of mountain tourism and ski villages in close proximity to historic environments, it is crucial to explore how to design in harmony with the local identity. This approach can create environments that feel connected to their specific site, generating authentic experiences for visitors and a meaningful connection to the local community.

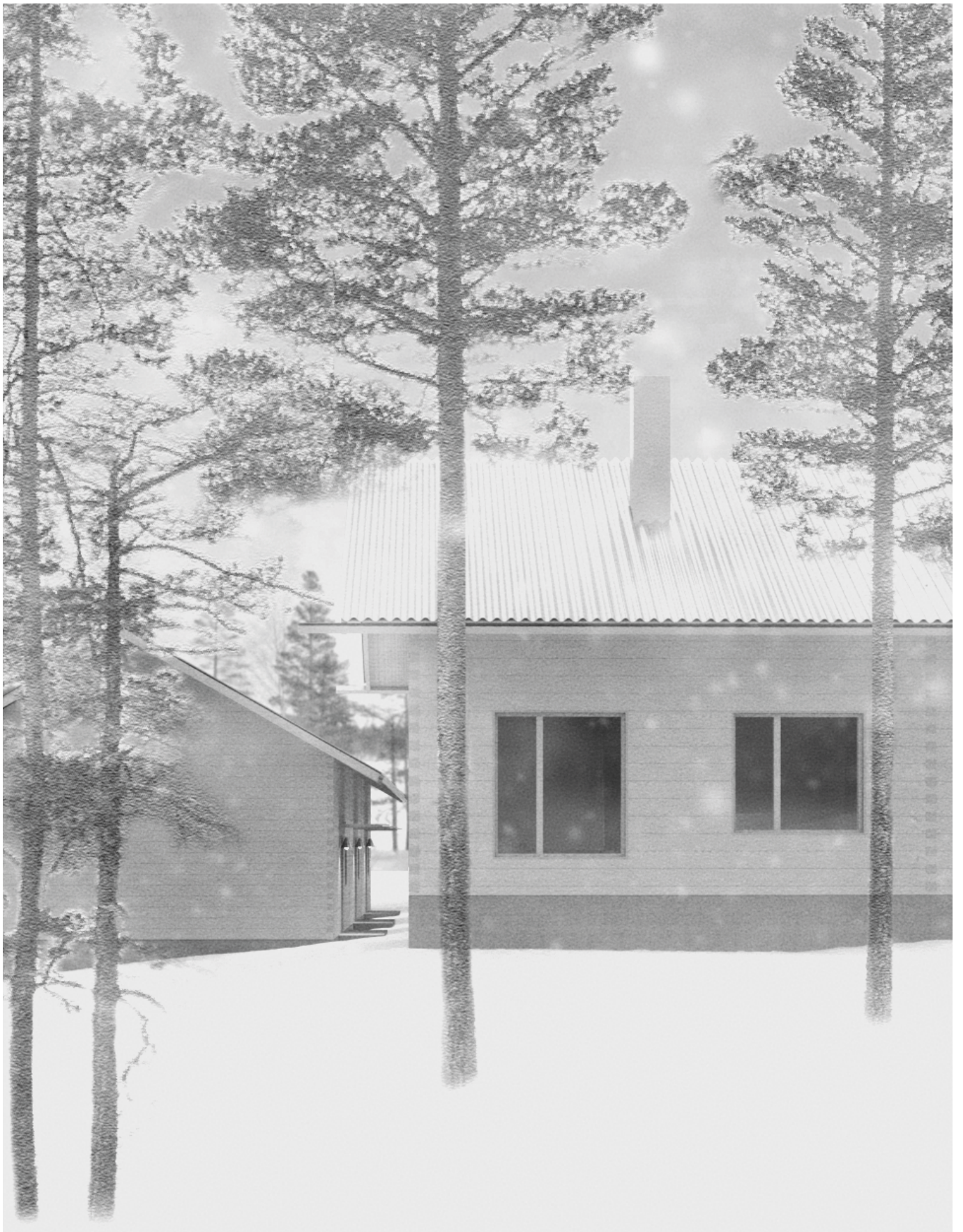

- Andersson, G. (2016). *Timmerbyggnader*. Göteborgs Universitet - Hantverkslaboratoriet.
- Byggnadsvårdsföreningen. (2020). *Knuttrimrade hus - enklare reparationer*. <https://byggnadsvard.se/knuttrimrade-hus-enklare-reparationer/>
- Celsing, J. (2007). *The robust and the sincere*. In P. Johnston, *Buildings, Texts* (pp. 113-120). Park Books.
- Canizaro, V. B. (2007). *Architectural Regionalism: Collected Writing on Place, Identity, Modernity, and Tradition*. Princeton Architectural Press.
- Destination Vemdalen. (n.d.). *Klövsjö*. Retrieved February 10 from <https://www.vemdalen.se/om-destination-vevdalen/vara-omraden/klovsjo/>
- Divisare. (2018, Aug 16). *Lenschow & Pihlmann Student Village*. <https://divisare.com/projects/393257-lenschow-pihlmann-hampus-berndtson-student-village>
- El Croquis. (2021). *N. 210/211 Gion A. Caminada 1995 2021*.
- Frampton, K. (1983). *Towards a Critical Regionalism: Six Points for an Architecture of Resistance*. General Architecture. (n.d.). *Nannberga*. Retrieved February 10 from <https://www.generalarchitecture.se/projekt/nannberga>
- Hidden Architecture. (2018). *Stiva da Morts*. <https://hiddenarchitecture.net/stiva-da-morts/>
- Håkansson, S.G. (2002). *Från stock till stuga*. (6th edition). ICA bokförlag.
- Jämtland Härjedalen Turism. (2023). *Fakta om turismen*. Retrieved from <https://jht.se/fakta-om-turismen-i-jamtland-harjedalen-2022/>
- Junchag, M. (2020). *Välådalen Naturum*.
- Länsstyrelsen Jämtland. (n.d.). *Tomtangården*. Retrieved February 10 from <https://www.lansstyrelsen.se/jamtland/besoksmal/kulturmiljoer/tomtangarden.html?sv>
- Public Health Agency of Sweden. (2023). *Friluftsliv*. Retrieved from <https://www.folkhalsomyndigheten.se/livsvillkor-levnadsvanor/friluftsliv/>
- Riksantikvarieämbetet. (2012). *Områden av riksintresse för kulturmiljövården i Jämtlands län (Z) enligt 3 kap 6 § miljöbalken*.
- SCB. (2020). *Tätortsbefolkning, antal efter region, kön, ålder och vart 5:e år*. Retrieved from https://www.statistikdatabasen.scb.se/pxweb/sv/ssd/START__MI__MI0810__MI0810A/TatortAlderNN/table/tableViewLayout1/
- Schulz, C. N. (1991). *Genius Loci: Towards a Phenomenology of Architecture*.
- Szacka, L. & Patteeuw, V. (2019). *Critical Regionalism for our time*. The Architectural Review. Retrieved from <https://www.architectural-review.com/essays/critical-regionalism-for-our-time>
- Västernorrlands museum. (n.d.). *Fåbodar*. Retrieved February 10 from <https://vnmuseum.se/byggnadsvard/kulturmiljoer-i-lanet/fabodar/>

- Figure 1 Smídek, P (n.d.). *Stiva da Morts*. [Online image]. Retrieved May 3, 2024. Archiweb. <https://www.archiweb.cz/en/b/svetnice-mrtvych-stiva-da-morts-totenstube>.
- Figure 2 Smídek, P (n.d.). *Stiva da Morts interior*. [Online image]. Retrieved May 3, 2024. Archiweb. <https://www.archiweb.cz/en/b/svetnice-mrtvych-stiva-da-morts-totenstube>.
- Figure 3 Caminada, G. A. (n.d.) *Floor plans*. [Online image]. Retrieved May 3, 2024. Hidden Architecture. <https://hiddenarchitecture.net/stiva-da-morts/>.
- Figure 4 Granada, J. (n.d.). *Walpen House*. [Online image]. Retrieved May 3, 2024. <https://jesusgranada.eu/walpen-house-gion-caminada>.
- Figure 5 Caminada, G. A. (n.d.). *Construction first floor plan*. [Digital drawing]. Retrieved May 3, 2024. N. 210/211 Gion A. Caminada 1995 2021. El Croquis.
- Figure 6 Granada, J. (n.d.). *Walpen House interior*. [Online image]. Retrieved May 3, 2024. <https://jesusgranada.eu/walpen-house-gion-caminada>
- Figure 7 No author. (n.d.). *Original structure*. [Online image]. Retrieved May 3, 2024. <https://www.pihlmann.dk/student-village>
- Figure 8 Berndston, H. (2017). *Studielandssbyen*. [Online image]. Retrieved from <https://www.pihlmann.dk/student-village>
- Figure 9 Lenschow, K. & Pihlmann, S. T. (2017). *Floor plan*. [Online image]. Retrieved from <https://www.pihlmann.dk/student-village>
- Figure 10 Grootveld, M. & Olsson, M. (n.d.). *Nannberga*. [Online image]. Retrieved May 3, 2024. <https://www.generalarchitecture.se/projekt/nannberga>
- Figure 11 General Architecture. (n.d.). *Floor plans*. [Online image]. Retrieved May 3, 2024. <https://www.generalarchitecture.se/projekt/nannberga>
- Figure 12 General Architecture. (n.d.). *Facade*. [Online image]. Retrieved May 3, 2024. <https://www.generalarchitecture.se/projekt/nannberga>
- Figure 13 Lantmäteriet. (2023). *Sweden vector map*.
- Figure 14 Jamtli. (2009). *Site plan, Tomtangården*. Tomtangården, vårdplan. Rapport - Jamtli 2009:10 ISSN 1654-2045



Anna Tegay

"Reclaimed Identity;
a restaurant and dwellings in Klövsjö"

Chalmers School of Architecture
Department of Architecture & Civil Engineering
Spring 2024