

THESIS FOR THE DEGREE OF MASTER OF SCIENCE

**CRUISE CONTROL USING PREVIEW
INFORMATION ABOUT THE ROAD AHEAD**

Stefan Bergquist and Fredrik Carlsson

Department of Applied Mechanics
CHALMERS UNIVERSITY OF TECHNOLOGY
Göteborg, Sweden, 2012

Cruise control using preview information about the road ahead

Stefan Bergquist and Fredrik Carlsson

© Stefan Bergquist and Fredrik Carlsson, 2012

Master thesis 2012-04

ISSN 1652-8557

Department of Applied Mechanics
Adaptive Systems
Chalmers University of Technology
SE-412 96 Göteborg
Sweden
Telephone: +46 (0)31-772 1000

Chalmers Reproservice
Göteborg, Sweden, 2012

Cruise control using preview information about the road ahead

Stefan Bergquist & Fredrik Carlsson
Department of Applied Mechanics
Chalmers University of Technology

Abstract

Advanced driver assistance systems in cars and trucks are getting ever more sophisticated with an emphasis on improving fuel efficiency, safety, and driver convenience. In a few years advanced navigation systems that can provide detailed real-time information about the road ahead are expected to become available. For this reason, it is important to investigate how assistance systems can be improved when this type of information becomes available.

In this thesis, the assignment is to improve an existing cruise control algorithm using foundation brakes by integrating information about the road ahead. The goal is that the behavior should resemble that of an experienced truck driver. By doing this, the algorithm assimilates potential energy available in downhill slopes. At the same time, speed conditions must be fulfilled and the brakes should be used in an effective way.

An algorithm has been developed that achieves the desired behavior. Before entering a descent, the speed is allowed to drop down to a defined minimum speed. When in the slope, the auxiliary brakes are used continuously while the foundation brakes are used for short periods of time when the speed reaches a defined maximum value. The brakes are controlled so that the vehicle leaves the slope at the maximum allowed speed.

In order to avoid brake disc wear and, in worst case, a sudden reduction of the brake capacity, the brake disc temperature is monitored. If necessary, the speed is reduced to reduce the utilization rate of the foundation brakes.

The results show that the behavior of an experienced driver can be approximated when introducing preview information in to the cruise controller algorithm. It has further been shown that the algorithm has the potential to reduce the foundation brake use with up to 10% in specific scenarios, compared to an existing cruise controller. The same comparison shows that the developed algorithm assimilates more available energy due to the speed reduction before a slope starts. This is achieved with only small effects on the average speed.

Key words: Cruise control, foundation brakes, auxiliary brakes, preview information, map data, heavy-duty truck, downhill driving strategies

Acknowledgements

First of all, we want to thank our main supervisor, Peter Lingman (Volvo 3P), for sharing his deep technical knowledge on trucks. In addition, he was always willing to spend long hours in the truck with us, no matter what day of the week. We would also like to thank our examiner, Mattias Wahde, professor at the Department of Applied Mechanics at Chalmers University of Technology, especially for the thorough feedback on the report.

Moreover, several persons at Volvo Technology should be recognized for their contributions, namely Lotta Holmén, Hans Deragården, Johan Fjellström, Anders Karlsson, Jonas Nilsson, Malte Ahrholdt, Robert Laxing and Wilhelm Wiberg (Volvo 3P).

At last, we want to express our gratitude towards all the members of the group Intelligent Vehicle Technologies at Volvo Technology who hosted us and were always nice and helpful.

Stefan Bergquist & Fredrik Carlsson
Göteborg, 2012

Abbreviations

AB	Auxiliary Brake
ADAS	Advanced Driving Assistance Systems
BC	Brake Cruise
CAN	Controller Area Network
CC	Cruise Control
CC-FB	Cruise Control including foundation brakes
CC-FBp	Cruise Control including foundation brakes using preview information
CR	Compact Retarder
E-horizon	Electronic Horizon
EBS	Electronic Brake System
EPG	Exhaust Pressure Governing
FB	Foundation Brake
GPS	Global Positioning System
IMU	Inertial Measurement Unit
RPC	Rapid Prototyping Control
VCB	Volvo Compression Brake
VEB	Volvo Engine Brake

Table of Contents

1	Introduction	1
1.1	Motivation	1
1.2	Related work and contribution	2
1.3	Objectives	2
2	Heavy vehicle braking strategies	3
2.1	Braking systems	3
2.1.1	Foundation brakes	4
2.1.2	Auxiliary brakes	4
2.1.3	Electronic brake system	6
2.2	Braking strategies	6
2.2.1	Downhill driving of an experienced driver	7
3	Vehicle modelling	9
4	Road preview information	11
4.1	The recorded data	11
4.2	Matching the position	11
4.3	The E-horizon	12
5	System description	15
5.1	System hardware architecture	15
5.2	CC with FBs using preview information	15
5.2.1	Comparison of cruise control algorithms	17

6	System implementation	19
6.1	System state: Find slope	19
6.2	System state: Enter slope	21
6.3	System state: In slope	21
6.3.1	Brake control	21
6.3.2	Deactivation of brakes	22
6.3.3	Brake disc temperature estimation	23
6.3.4	Stationary speed calculation	25
7	System evaluation	27
7.1	Simulated vehicle tests	27
7.1.1	Brake behavior for CC-FBp	27
7.1.2	Comparison between CC-FBp and CC-FB	28
7.2	Real vehicle tests	31
7.2.1	Downhill driving	31
7.2.2	Temperature estimation and stationary speed	32
8	Discussion	37
9	Conclusion	38

Chapter 1

Introduction

The **advanced driver assistance systems (ADAS)** in cars and trucks are getting ever more sophisticated and advanced with an emphasis on improving fuel efficiency, safety and driver convenience. As new technologies become available, assistance systems can evolve even further. In a few years, advanced navigation systems containing a **global positioning system (GPS)** receiver connected to a detailed map database is expected to become widely available on the market. This type of systems can provide detailed real-time information about the road ahead, allowing further improvements of ADAS.

1.1 Motivation

The **cruise control (CC)** is a widely used assistance system that aims to help the driver to keep a desired speed, referred to as the **set speed** [1]. The CC does not handle braking and, in addition to this system, Volvo trucks are equipped with a **brake cruise (BC)**. When the BC is activated, the control algorithm is allowed to use the brake system to maintain the desired speed, something that is needed in downhill slopes.

Volvo trucks are equipped with two different brake systems, the **auxiliary brakes (ABs)**¹ and the **foundation brakes (FBs)**² [2]. The ABs are less powerful and can be used continuously while the FBs are more powerful and should only be applied for short periods of time to avoid brake disc wear. Another problem that can occur when using the FBs is that the brake discs get too warm. At a certain temperature, the friction between the disc and the pads starts to reduce. This phenomenon is called **fading** and can lead to severely reduced braking capacity. It is therefore important to use the FBs with care and to monitor the brake disc temperature.

The CC today only uses the ABs which in steep downhill slopes is not always sufficient to maintain the desired speed [1]. This causes the driver to intervene and

¹Several types of ABs exist, they all apply the braking effect to the driveline.

²The FBs are normally of disc brake type and affect each tire individually.

take control over the vehicle. It would be desirable to allow the CC to use the FBs in order to increase system usability .

It is important to apply the FBs at the correct time since they can only be used for short periods of time and not continuously in a slope. Applying the brakes at the wrong time can lead to, for example, braking just before the slope ends and loosing valuable energy. To handle this, information about the upcoming road could be used.

1.2 Related work and contribution

Braking heavy vehicles in downhill slopes is a complex problem which has been investigated by Lingman [2] in his PhD thesis concerning downhill driving and integrated braking control. The thesis describes the truck brake systems and how to utilize them. A more thorough description of the developed strategies is given in Chapter 2.

Carlsson and Glad [1] describe how a **CC algorithm including FBs (CC-FB)** was integrated in a Volvo truck. When the speed increases over a predefined speed, the FBs are applied to bring the speed back down to the set speed. This behavior is repeated until the downhill slope ends. The algorithm does not use information about the road ahead. The authors point out a number of associated problems where the main challenge is to find the end of the slope. This is needed to assure high speed when leaving the slope to utilize as much potential energy as possible.

Much work has been conducted in the area of optimizing real-time speed control by including information about the road ahead. The solutions commonly employ a cost function which is supposed to be minimized to find the optimal speed plan for an upcoming road. A patent on this matter was granted to Neiss et al. [3]. Similar work has been performed by, for example, Hellström [4] and Kozica [5] who have focused on the area of preview information based speed control of heavy vehicles. However, Neiss, Hellström and Kozica, all assume that it is possible follow any desired speed profile. Doing that would require continuous use of the FBs which should be avoided.

This thesis report aims to contribute to the area of preview information based heavy vehicle speed control including foundation brakes.

1.3 Objectives

The objective of this thesis is to improve the brake behavior of the existing CC-FB by utilizing information about the road ahead. The developed algorithm is referred to as **CC-FBp**. The goal is to imitate the desired behavior of an experienced driver. In doing this, the system will aim to assimilate as much potential energy as possible in downhill slopes without violating defined speed conditions or overheating the brakes. The algorithm should be implemented and tested in a prototype truck.

Chapter 2

Heavy vehicle braking strategies

A Volvo truck is equipped with both FBs and ABs [2]. If the available braking forces in those systems are combined in a correct way, safety is increased and the brake system wear can be reduced. How the systems are used together in reality is highly dependent on the driver [6]. A conservative driver might choose a low speed resulting in low utilization rate of the brake capacity, yielding a lower average speed than necessary. An aggressive driver might choose a high speed leading to extensive usage of the FBs which results in unnecessary brake system wear.

2.1 Braking systems

The FBs and the ABs apply their brake force in different ways. While the FBs work individually on each wheel, the ABs affect the driveline of the vehicle [2]. This is illustrated in Figure 2.1.

The FBs can be either drum brakes or disc brakes. On Volvo trucks, the ABs are most often the **Volvo engine brake (VEB)** and, in trucks designed for extra braking capacity, there is an additional hydraulic system called the **compact retarder (CR)** [2]. In general, the ABs are used to reduce the utilization of the FBs. Usage of the FBs leads to brake disc wear and high costs. In extreme situations, it can even lead to reduced braking performance. ABs are sometimes called non-wear brakes and, as the name implies, usage does not result in wear and costs¹. Therefore, ABs should be used as much as possible, especially in steep and long downhill slopes.

¹Research has shown that this is not necessarily true [2]. Drivers have noticed increased drive tyre wear with extensive use of the ABs. To minimize the cost, the brake systems should be combined. In long and steep slopes, it is however not possible to reach the optimal ratio since the ABs are not powerful enough. In those situations, the ABs should be used as much as possible.

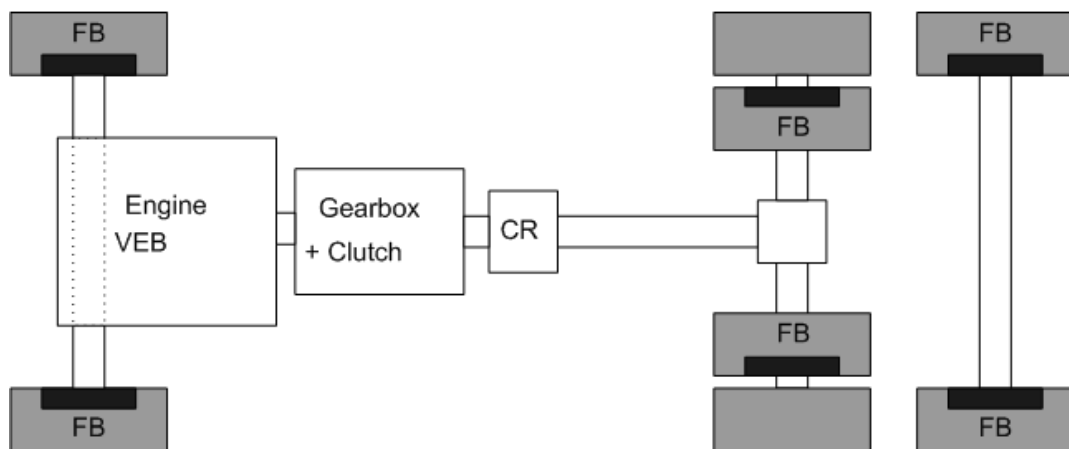

Figure 2.1: Volvo braking system [1]. Reproduced with permission.

2.1.1 Foundation brakes

In this report, only disc brakes, seen in Figure 2.2, are considered since they are dominating the Volvo share of the market, especially in Europe [7, 8].

When the brake pedal is pressed, the brake cylinder placed by the wheel is filled with air [2]. This creates a pressure on the piston that presses the braking pads against the rotating brake disc. The friction between the pad and the disc generates the force which brakes the vehicle. It is obvious that this leads to increased temperature and wear of the brake discs. How the brake disc temperature changes in downhill driving is shown in Figure 2.3.

When the FBs are applied, the speed decreases and the brake disc temperature increases [1]. If the temperature becomes too high, fading appears. To avoid overheating the brakes, continuous usage of the FBs should be avoided, and instead short brake pulses should be used. This will reduce brake system wear and the risk of fading.

2.1.2 Auxiliary brakes

The most common AB in Volvo trucks is the VEB which consists of two different parts; the **exhaust pressure governor (EPG)** and the **Volvo compression brake (VCB)**. The VEB is mounted in front of the gearbox which makes the braking torque gear dependent. It is therefore called a **primary retarder** [2]. Here, only a short description of the different parts is presented. For a thorough description, the reader is referred to Lingman (2005) [2].

The EPG uses the exhausts from the engine to create a resistance torque in the exhaust manifold [2]. By controlling a valve which reduces the exit area for the exhausts from the engine, an overpressure is created. This pressure results in a braking torque on the driveline.

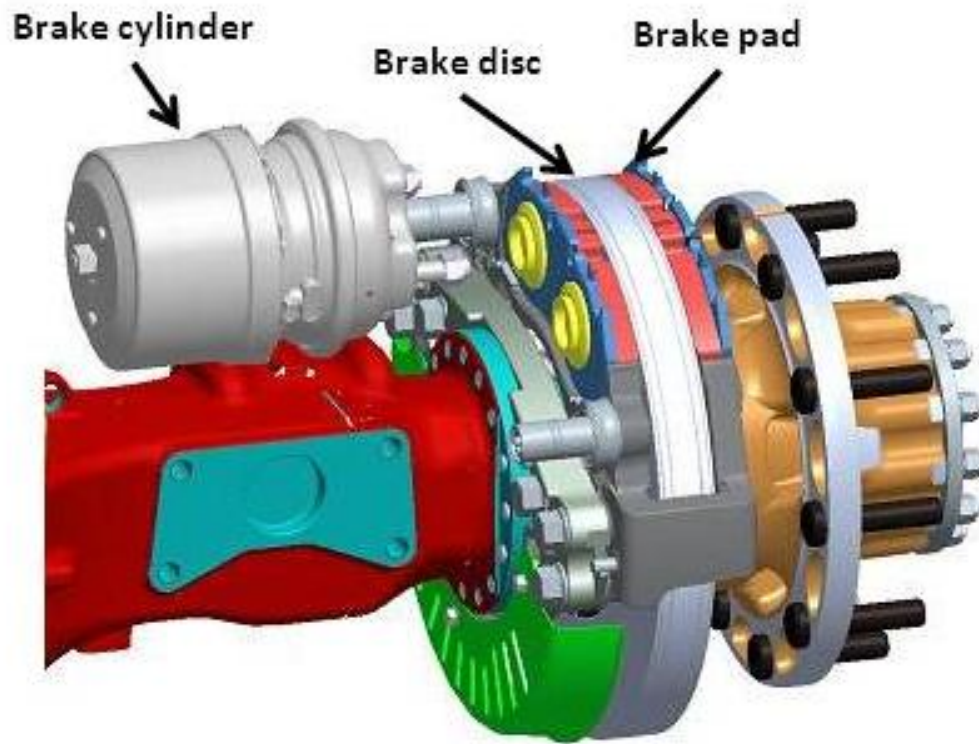

Figure 2.2: Volvo disc brake [9]. Reproduced with permission.

The VCB mechanically changes the normal exhaust stroke to a compression stroke by reducing the size or closing the exhaust outlet from the cylinder [2]. This creates a pressure which results in a braking force on the piston. In the end of the stroke, the outlet is opened and the exhausts can exit the cylinder. By doing so, the compressed gas does not generate a driving force during the following cylinder stroke.

Stationary speed

In order to avoid high brake disc temperature in steep downhill slopes, it might be necessary to lower the gear and thereby enable a higher torque output from the primary retarder [1]. If the gear is low enough, the braking torque from the auxiliary brakes will be sufficient to keep the vehicle at a constant speed. Therefore, the FBs do not have to be used at all. The **stationary speed**, v_{stat} , is defined as the maximum speed that can be held in downhill driving without using the FBs. Stationary speeds for different slopes and weights are shown in Figure 2.4.

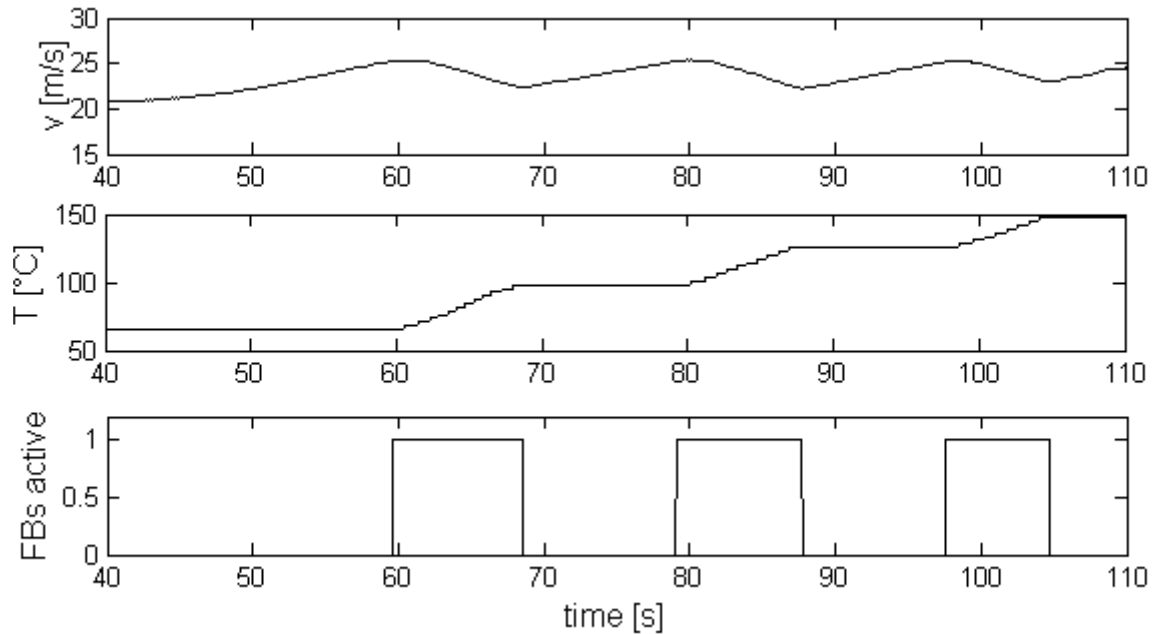

Figure 2.3: *Disc temperature when braking.*

2.1.3 Electronic brake system

In an **electronic brake system (EBS)**, the pneumatic transmission between the braking pedal and the valve which allows air to enter the brake cylinder has been replaced by electronic signals [1]. When using the brakes, the pedal position is measured and sent to the EBS which calculates the responding brake pressure and controls the valve. There is still a pneumatic backup to maintain system safety if the electronics should fail. In addition to faster response in the braking system, the EBS functionality makes new functions possible, such as ADAS using the brakes and brake force distribution between the different wheels.

2.2 Braking strategies

Driving in a steep downhill slope with a heavy vehicle is not as straightforward as for a passenger car [2]. The weight of the vehicle can lead to high acceleration which, in turn, can lead to high speeds. Handling the situation sets high demands on the braking system, as well as on the driver.

The responsibility of the driver is not only to get the vehicle from one place to another. It is very important to drive the vehicle safely and to reduce the wear and fuel

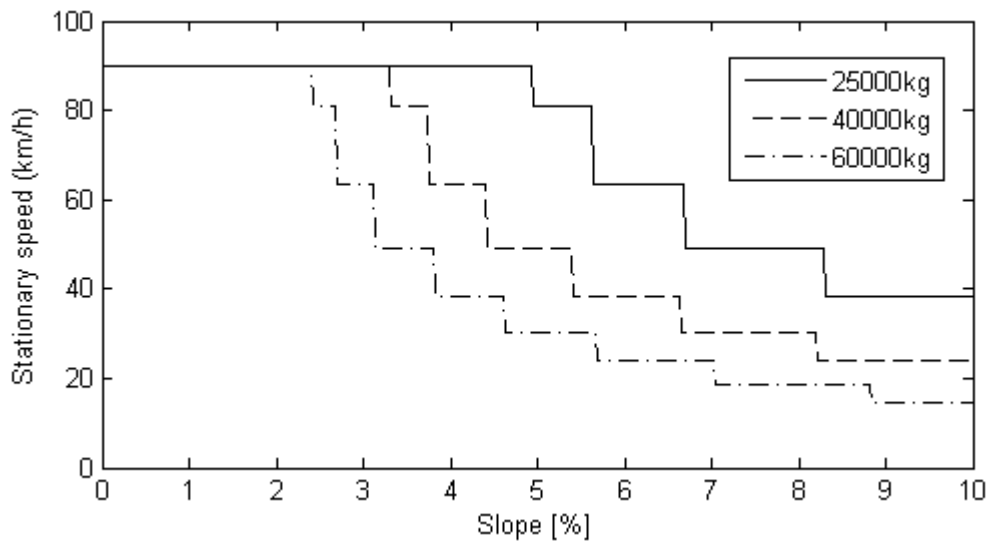

Figure 2.4: Stationary speeds for different slopes and vehicle weights [1]. Reproduced with permission.

costs as much as possible while still keeping an acceptable average speed. This is an art that the driver learns to master with experience.

2.2.1 Downhill driving of an experienced driver

The driving behavior in downhill slopes of course varies between drivers. The desired speed profile of an experienced driver is graphically illustrated in Figure 2.5. Before an upcoming downhill slope, it is beneficial to allow the speed to drop to some extent [10]. When entering a slope the truck starts to accelerate. To handle this, the driver activates the ABs [2]. If the braking torque generated is not high enough, the truck will continue to accelerate. When the velocity gets too high, the driver uses the FBs for a short period of time to bring the vehicle speed down to the desired velocity. This sequence is repeated throughout the slope. If the slope is long, the driver might choose to reduce the speed to achieve higher torque output from the ABs. Normally, the driver assesses an upcoming slope when approaching and if necessary, reduces the set speed before entering the slope [2]. The speed is often not reduced all the way down to stationary speed, but instead to **semi-stationary speed**. At this speed, the vehicle will still accelerate to some degree, but at a much lower rate than before and the FBs need to be used less.

In the end of the slope, the driver wants to conserve the free energy available in the slope [1]. Therefore, the driver releases the brakes and allows the vehicle to accelerate to a maximum accepted speed just before the slope ends.

The behavior presented above is not easy to achieve since the driver does not get

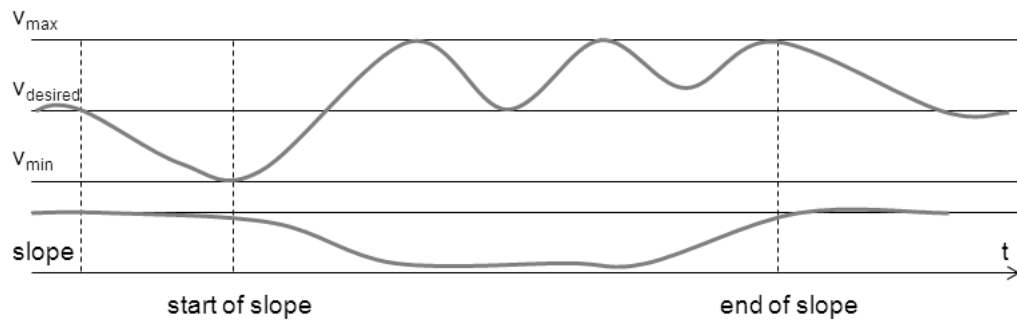

Figure 2.5: *Desired speed profile in downhill driving for an experienced truck driver.*

any exact feedback about, for example, the brake disc temperature and vehicle weight [2]. Therefore, an experienced driver is needed to make a correct judgement regarding how to distribute the braking energy between the different brake systems.

Chapter 3

Vehicle modelling

A truck in a downhill slope is affected by a number of forces [1]. The external forces are due to the gravity, the air resistance, the roll friction and the engine friction. How they affect the vehicle can be seen in Figure 3.1.

First of all, the part of the gravity force acting longitudinally on the truck is given by

$$F_{g,\text{long}} = mg \sin \alpha \quad (3.1)$$

where m is the mass of the truck, g the constant of gravity, and α the current road slope angle as defined in Figure 3.1. Secondly, the air resistance force is given by

$$F_{\text{air}} = \frac{C_d A \rho}{2} v^2 \quad (3.2)$$

where C_d is the numerical drag coefficient, A the front area of the truck, ρ the air density, and v the current velocity of the truck. Furthermore, the roll resistance force is given by

$$F_{\text{roll}} = C_r mg \cos \alpha \quad (3.3)$$

where C_r is the roll friction coefficient. Finally, the engine resistance force is given by

$$F_{\text{eng}} = f(\omega_{\text{eng}}) \frac{N_G N_F}{R} \quad (3.4)$$

where $f(\omega_{\text{eng}})$ is a function describing how F_{eng} relates to ω_{eng} , N_G the current gear ratio, N_F the final gear ratio, and R the wheel radius.

When no engine or braking torque is affecting the vehicle, the resulting force in downhill driving is given by

$$F_{\text{res}} = F_{g,\text{long}} - F_{\text{air}} - F_{\text{roll}} - F_{\text{eng}}. \quad (3.5)$$

If braking and engine forces are affecting the vehicle, the resulting force is instead

$$F_{\text{res}} = F_{g,\text{long}} - F_{\text{air}} - F_{\text{roll}} - F_{\text{eng}} - F_{\text{AB}} - F_{\text{FB}} + F_{\text{eng}} \quad (3.6)$$

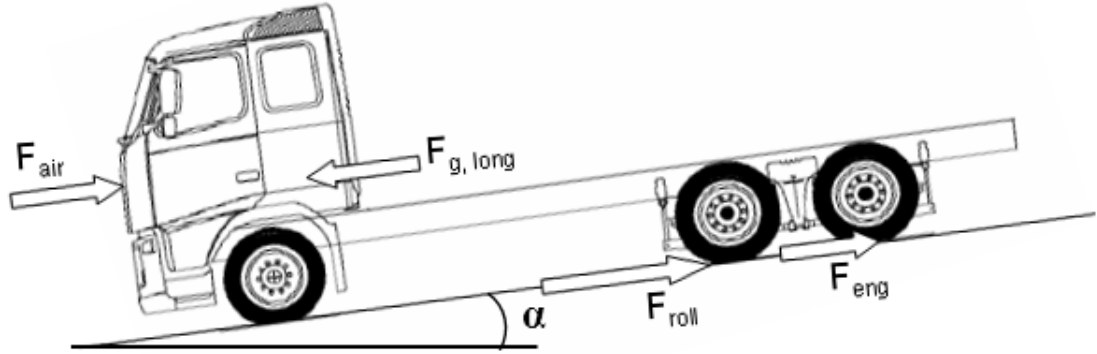

Figure 3.1: *Truck with forces.*

where F_{AB} and F_{FB} is the forces generated by the brake systems and F_{eng} is the force generated by the engine.

A discrete, first-order, model for the longitudinal movement of the truck is given by

$$\begin{cases} s(k) = s(k-1) + v(k-1)\Delta t \\ v(k) = v(k-1) + \dot{v}(k-1)\Delta t \\ \dot{v}(k) = \frac{F_{\text{res}}(k)}{m} \end{cases} \quad (3.7)$$

where s is the driven distance, Δt the sample time, and k the sample point in time. The derivatives are kept constant during the sample period.

Chapter 4

Road preview information

Due to limited availability of road data covering suitable road stretches, data had to be collected. For this purpose a high precision measuring system utilizing both a differential GPS and an **inertial measurement unit (IMU)** was used.

4.1 The recorded data

The measurement system can be used to collect different information about both the road and vehicle but, in this thesis, only the GPS position and the road slope were recorded. Figure 4.1 shows the road slope profile for Road 40 between Landvetter and Kallebäck outside Göteborg, Sweden. The road slope is stored in a matrix along with the logged GPS position. From this matrix, the **electronic horizon (E-horizon)** describing the road ahead can be generated if one knows the position of the vehicle. For this purpose, a GPS receiver is used.

The GPS data have limited availability and accuracy, something that need to be considered when the data are used in ADAS. The accuracy of the received position depends on several factors such as the number of available satellites and weather conditions [11]. It is usually estimated that the measured position is within ten meters of the true position. The availability of data is also subject to disturbances and sometimes it is not possible to receive updated positions. Therefore, it is useful to complement any algorithm using GPS position with dead reckoning based on the vehicle movement.

4.2 Matching the position

Once the vehicle position coordinates are acquired from the GPS receiver mounted on the truck, the corresponding coordinates in the recorded data need to be found. For

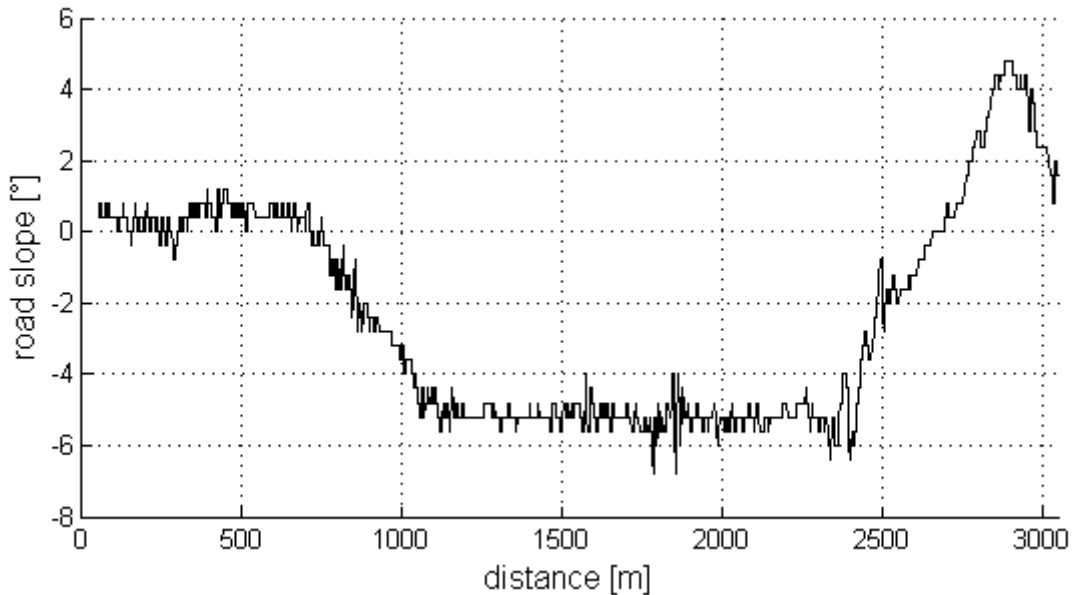

Figure 4.1: Road slope between Landvetter and Kallebäck.

this purpose, a **closest-point-algorithm**¹ is used. The matched position is used as the start point when the E-horizon is generated. In Figure 4.2, the difference between the received positions and the closest recorded positions from a test run is shown. As seen, the difference is up to 3 meters. It should be pointed out that this is not the difference between the received and the true position. It is the difference between the received position and the closest point in the recorded data. Given the uncertainty in the GPS reading, the closest point is not necessarily the true position. However, a small difference indicates that the positioning algorithm is performing well.

Another way to ensure that the positioning algorithm is working, is to compare the current slope from the E-horizon during a test drive to the recorded road slope for the corresponding road segment. If the positioning algorithm is correct, the graphs should look similar. In Figure 4.3, it is possible to compare the two graphs. Even though the units in the two graphs differ, it is obvious that the road slopes are similar.

4.3 The E-horizon

An example from the E-horizon sent to the control algorithm is shown in Table 4.1. It is designed to look like the output from an existing platform commonly used for inte-

¹The closest-point-algorithm calculates the differences between the current and all recorded positions in order to find the closest position.

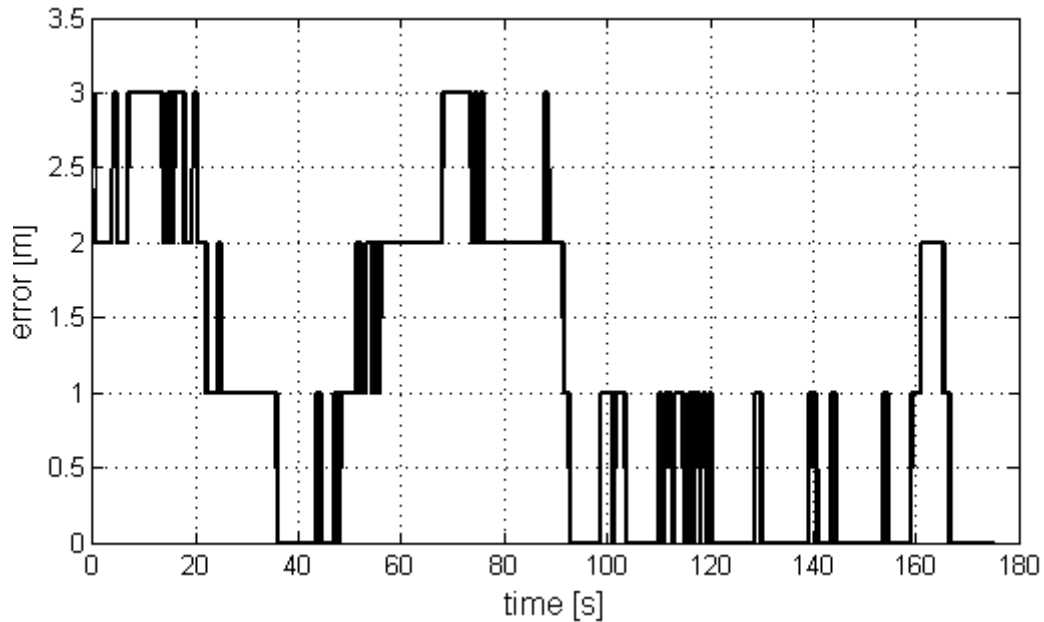

Figure 4.2: *Difference between received position and the closest point in the recorded data.*

grating preview information into ADAS. The E-horizon is made up of segments with different road slope. The columns, from left to right, contain identification number, distance to the start of the segment [m], length of the segment [m], and the road slope [°]. The resolution of the slope in this example is 0.4° . It can be altered but if it is too low, the algorithm will work poorly. On the other hand, if it is too high, more data need to be transferred and calculations will be more time consuming.

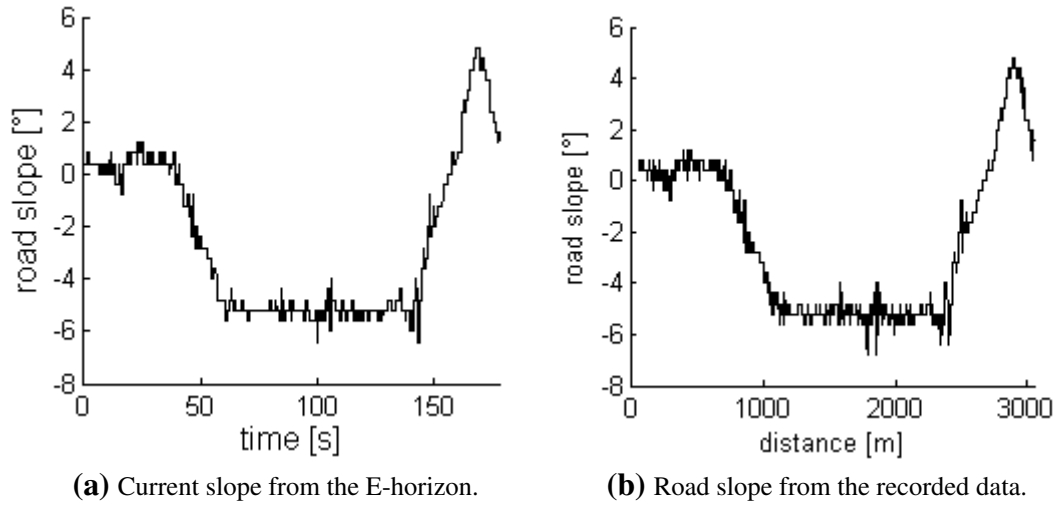

Figure 4.3: Comparison between road slope from E-horizon and from the recorded road data.

1	-12	20	0.4
2	8	2	0
3	10	3	0.4
4	13	8	0.8
5	21	2	0.4
6	23	2	0
7	25	5	-0.4
8	30	7	0
9	37	9	-0.4
10	46	5	0

Table 4.1: An example of the E-horizon presented to the algorithm.

Chapter 5

System description

In this chapter, the system architecture for the CC using preview information is presented. Moreover, the developed algorithm is described and its functionality is compared to the existing CC algorithms.

5.1 System hardware architecture

The CC-FBp algorithm uses information about the road ahead to achieve the desired behavior. The hardware architecture of the system can be seen in Figure 5.1.

GPS data from the satellites are obtained by a receiver on the truck which sends the GPS position to the E-horizon provider. In this unit, the position is matched to the recorded data and an E-horizon is generated. The horizon is sent over a **Controller Area Network (CAN)** bus to the **rapid prototyping control(RPC)** unit. The control unit additionally receives necessary vehicle data such as current speed and gear over the vehicle CAN bus. In the RPC unit, appropriate control commands are calculated based on the input. The commands are sent to the engine and brake control units that control the acceleration of the vehicle.

5.2 CC with FBs using preview information

When activating the CC-FBp, the driver sets v_{set} , v_{min} and v_{max} . Once the system is active, the algorithm continuously searches the E-horizon for a downhill slope that will accelerate the vehicle. When a start point of such a slope, p_{start} , is found, the features are analyzed to decide if the slope is sufficiently long and steep to bring the speed from v_{min} to v_{set} . If this is the case, the engine torque, τ_{eng} , will be deactivated so that the velocity is reduced down to v_{min} before the slope starts.

When the vehicle enters the slope, the truck will start to accelerate. If the slope is long and steep, the speed will increase all the way to $v_{\text{max,AB}} = v_{\text{max}} - \Delta v$. At this

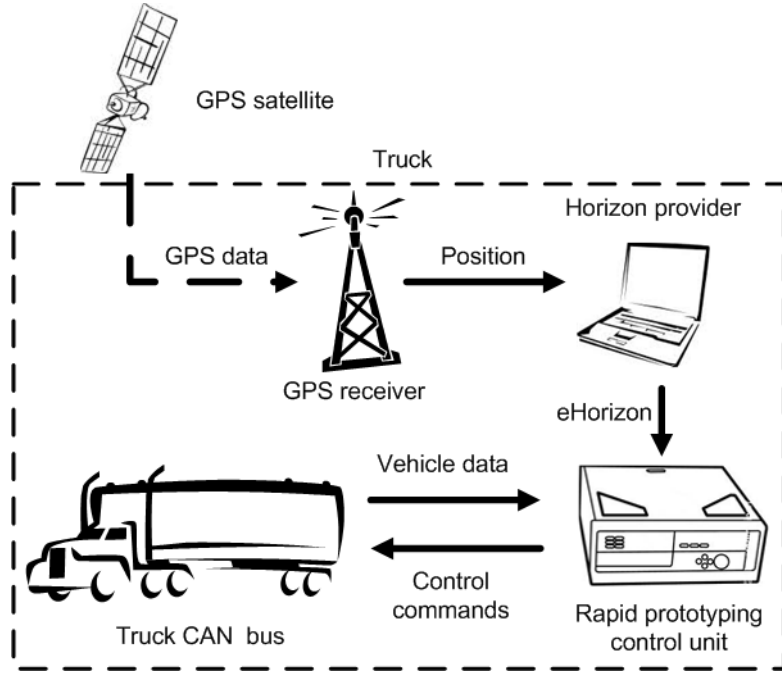

Figure 5.1: System architecture for the CC-FBp.

point, the ABs are applied. Δv is a threshold which separates the activation point for the ABs, from the activation point for the FBs. This gives the ABs a chance to stabilize the speed if the generated torque is sufficient for the current slope. If not, the speed will continue to increase and when v_{\max} is reached, the FBs are applied.

While in the slope, the algorithm searches the E-horizon for the end point, p_{end} . When the point has been found, the algorithm aims to achieve v_{\max} when exiting the slope.

If the vehicle is in a steep slope, the brake disc temperature can rise to high levels. To avoid overheating the brake discs, the temperature is continuously monitored. If the temperature reaches a warning level, T_{warn} , the temperature in the end of the slope, \hat{T}_{end} , is estimated. In order to find an estimate, one must also have found the end of the slope. In addition, one brake pulse needs to have been completed. If this is not the case, the vehicle speed will be reduced to v_{stat} to avoid overheating the brake discs. When an estimate is available, it is compared to a critical temperature, T_{crit} . If \hat{T}_{end} is above T_{crit} , the vehicle speed is reduced to $v_{\text{semi-stat}}$. If not, the speed is not reduced. The temperature range between T_{warn} and T_{crit} ensures that it is always possible to perform one long brake pulse without risking overheating the brakes. Using the estimate makes it possible to avoid lowering the speed to $v_{\text{semi-stat}}$ if the slope is about to end. This is in comparison to the CC-FB, where $v_{\text{semi-stat}}$ always have to be used when T_{warn} is reached since no information about the road ahead is available.

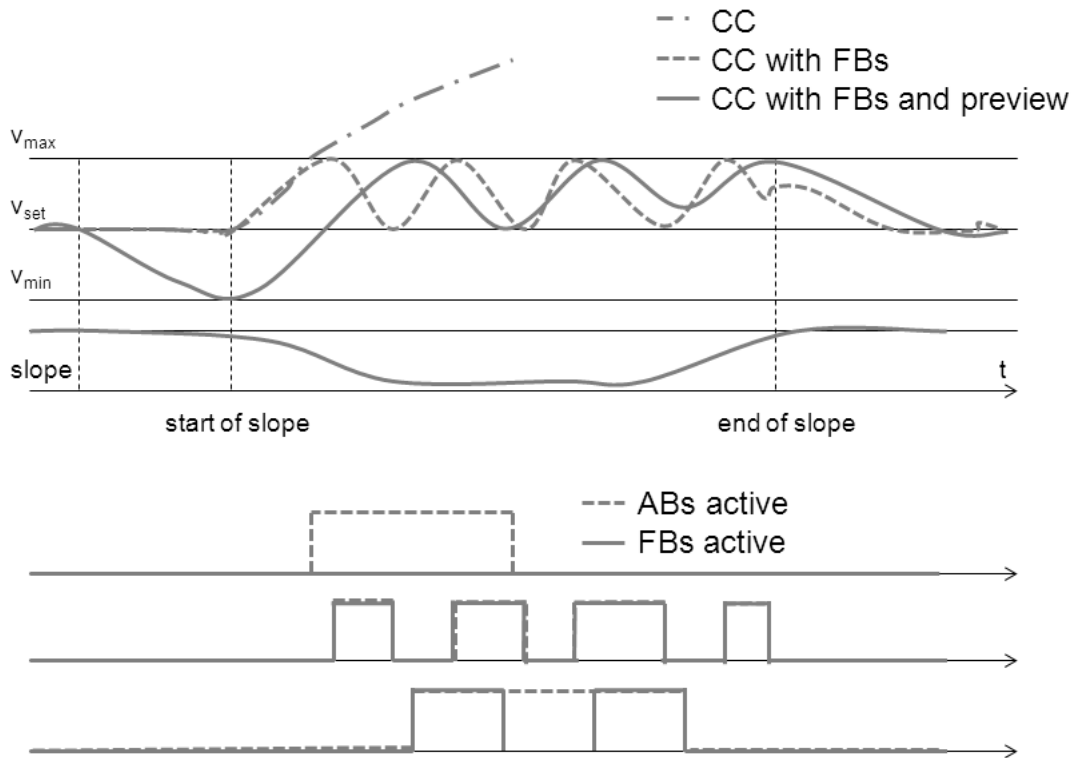

Figure 5.2: *CC behavior in downhill driving.*

5.2.1 Comparison of cruise control algorithms

Figure 5.2 visually describes the behavior of three different CC algorithms in downhill driving. The three algorithms are: The ordinary CC which is in production, the CC-FB and the CC-FBp. When activating any of the CCs, the driver chooses a set speed, v_{set} . If he wants to, it is possible to set a maximum allowed speed, v_{max} . For the CC-FBp, a minimum allowed speed, v_{min} , can also be chosen. If the driver does not set the speeds, predefined values are used.

As can be seen in the speed profile for the ordinary CC, the speed will increase when the slope starts. When v_{max} is reached, the ABs are activated. However, in a steep slope, the speed will continue to increase and eventually the driver will have to intervene. The FBs are never applied by the algorithm.

When using CC-FB, the speed will be reduced down to v_{set} after reaching v_{max} . This is achieved by applying the ABs and FBs for a short period of time. The behavior is repeated throughout the slope. The point where the slope ends is estimated without preview information, instead estimates of the current slope and its gradient are compared to threshold values [1]. The approach is sensitive to different road profiles and

often detects the end of the slope too late to achieve the desired speed increase.

The behavior of the CC-FBp is also shown. Before the slope starts, the speed is allowed to drop down to v_{\min} . This saves fuel and the brakes can be applied at a later time compared to the other two CCs. When the speed reaches v_{\max} , it is brought down to v_{set} in the same way as described for the CC without preview information. However, in this case the ABs are continuously used throughout the slope, which leads to less utilization of the FBs. The end of the slope is estimated using preview information which makes it possible to ensure a speed close to v_{\max} when exiting the slope. The behavior is designed to resemble that of an experienced truck driver, described in Section 2.2.1.

Chapter 6

System implementation

The developed algorithm has three main states (shown in Figure 6.1), namely **find slope**, **enter slope** and **in slope**. When the algorithm is in *find slope*, the controller aims to keep the set speed while searching for a downhill slope. Once the starting point, p_{start} , is found at a distance ahead of the current vehicle position, s_{start} , the algorithm changes state to *enter slope*. When *enter slope* is active, the algorithm aims to reach v_{min} at p_{start} . This is achieved by deactivating the engine torque before the slope starts. When the vehicle has passed p_{start} , the speed will start to increase. The active state changes back to *find slope* when the speed reaches v_{set} .

If the speed reaches $v_{\text{max,AB}}$, the state changes to *in slope*. In this state, the algorithm handles several processes: The brakes are controlled, the brake disc temperature is supervised, and the algorithm searches for the ending point of the slope, p_{end} . Once p_{end} is found at a distance ahead of the current vehicle position, s_{end} , the algorithm aims to deactivate the brakes so that v_{max} is reached at p_{end} . When this point has been passed, the velocity will begin to decrease. Once the speed reaches v_{set} , the algorithm changes state from *in slope* to *find slope*.

The CC-FBp is only allowed to request engine torque when the algorithm is in either *find slope* or *enter slope*. The brakes can only be applied when *in slope* is active.

6.1 System state: Find slope

When *find slope* is active the algorithm keeps v_{set} . This is achieved by requesting the active set speed from the engine control unit. Simultaneously, the algorithm searches the E-horizon for p_{start} . Here, a downhill slope is defined as a descent with continuous positive acceleration and enough potential energy to bring the speed from v_{min} to v_{set} .

For the vehicle to accelerate, the gravity force generated by the slope must be greater than the resistance forces acting on the truck. Referring to Equation 3.5, this

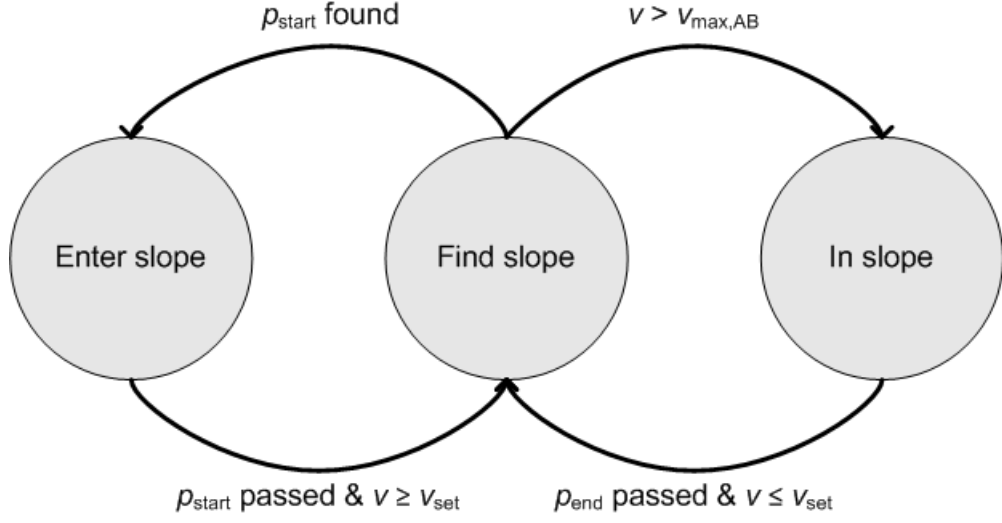

Figure 6.1: CC-FBp system states.

situation occurs when

$$F_{g,\text{long}} > F_{\text{air}} + F_{\text{roll}} + F_{\text{eng}}. \quad (6.1)$$

Once a point has been found for which this condition is fulfilled, a simulation in the longitudinal direction starting in that point is carried out. The model used follows Equation 3.7,

$$\begin{cases} s(k) = s(k-1) + v(k-1)\Delta t \\ v(k) = v(k-1) + \dot{v}(k-1)\Delta t \\ \dot{v}(k) = \frac{F_{\text{res}}(k)}{m} \end{cases}$$

where F_{res} is given by Equation 3.5. The initial values for the defined states are

$$\begin{cases} s(0) = 0 \\ v(0) = v_{\text{min}} \\ \dot{v}(0) = \frac{F_{\text{start}}}{m} \end{cases} \quad (6.2)$$

where F_{start} is calculated based on v_{min} , the current ω_{eng} , the current N_{G} , and α in the found point.

During the simulation, $\omega_{\text{eng}}(k)$ and $N_{\text{G}}(k)$ are held constant at their current values. This assumes that any changes in these variables can be neglected. $\alpha(k)$ is extracted from the E-Horizon in every sample point. The simulation continues until either $v(k) > v_{\text{set}}$ or $v(k+1) < v(k)$.

If the simulation is stopped due to the first condition, the potential energy available in the upcoming slope is sufficient to achieve the desired speed gain. Therefore, p_{start}

has been found and s_{start} is calculated as the distance between the current position and the found point. If the simulation is stopped due to the second condition, the acceleration is not continuously positive. Therefore, a start point has not been found and the algorithm continues the search in the next sample.

6.2 System state: Enter slope

In *enter slope*, the aim is to reach v_{min} at p_{start} . In order to do so, an estimate of the speed at p_{start} , \hat{v}_{start} , is generated. The estimate is compared to v_{min} to decide whether the engine torque should be deactivated. A state flow chart describing the decision algorithm is shown in Figure 6.2.

A prediction of \hat{v}_{start} based on the current vehicle state is made using the model in Equation 3.7. The states are initiated with

$$\begin{cases} s(0) = 0 \\ v(0) = v \\ \dot{v}(0) = \frac{F_{\text{res}}}{m} \end{cases} \quad (6.3)$$

where F_{res} is calculated based on the current vehicle state in the same way as described in Section 6.1. The simulation is run until $s(k) = s_{\text{start}}$, which provides $\hat{v}_{\text{start}} = v(k)$. Once \hat{v}_{start} is available, it is compared to v_{min} . If $\hat{v}_{\text{start}} > v_{\text{min}}$, the engine torque is deactivated. Otherwise, if $\hat{v}_{\text{start}} \leq v_{\text{min}}$, the engine torque is not deactivated at this stage.

As long as the engine torque is not deactivated, the calculations are repeated for every new sample point. When the vehicle is sufficiently close to p_{start} , $\hat{v}_{\text{start}} > v_{\text{min}}$ will be fulfilled and the engine torque will be deactivated.

6.3 System state: In slope

When *in slope* is active, the task of the algorithm is to keep the vehicle speed within the speed limits and to reach v_{max} at p_{end} . At the same time, the brake disc temperature needs to be monitored.

6.3.1 Brake control

The brakes are controlled to follow the behavior described in Section 2.2.1. Figure 6.3 shows the CC-FBp brake control state flow. When driving on flat road, the ABs and FBs are *not active*. When the vehicle enters a descent, the speed will start to increase. At speed $v_{\text{max,AB}}$, the algorithm enters *in slope* and the ABs are applied. If the speed

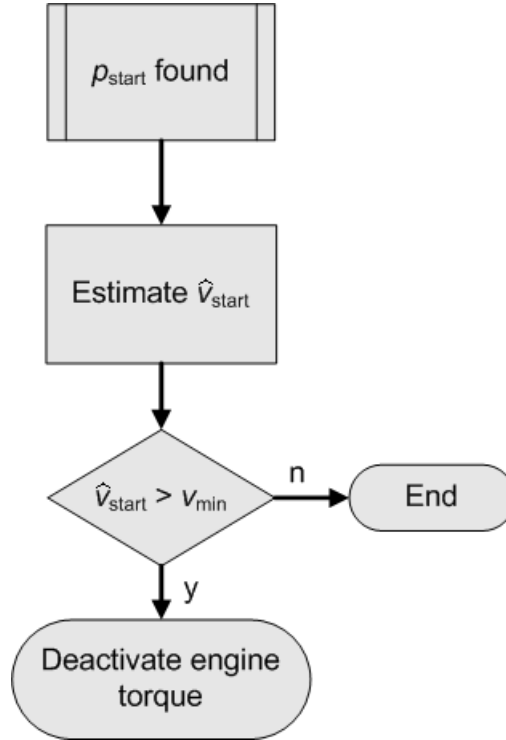

Figure 6.2: Flow chart describing the algorithm used in enter slope.

continues to increase, the FBs are activated at v_{\max} and remain activated until the speed reaches v_{set} . The duration of the brake pulse is usually five to ten seconds, see Figure 2.3. After that, the FBs are not applied until the speed, once again, reaches v_{\max} . The brake pulse is repeated as many times as needed in the slope.

At some point in the downhill slope, the brake control algorithm will deactivate the brakes to reach v_{\max} at p_{end} . At this point, both the ABs and FBs are deactivated. When the vehicle has left the slope, the brakes will not be applied again until the next slope in which the speed reaches $v_{\max, \text{AB}}$.

6.3.2 Deactivation of brakes

The deactivation of the brakes works basically in the same way as the deactivation of the engine torque. First, the algorithm searches for an end point of the slope, p_{end} , using the method explained in Section 6.1. In this case, the algorithm searches the E-horizon for a point where the acceleration is negative, which occurs when

$$F_{g, \text{long}} < F_{\text{air}} + F_{\text{roll}} + F_{\text{eng}}. \quad (6.4)$$

If the point is the start of a road segment in which the speed is reduced from v_{\max} to v_{set} , it is defined to be the end point of the slope. In order to establish whether such a

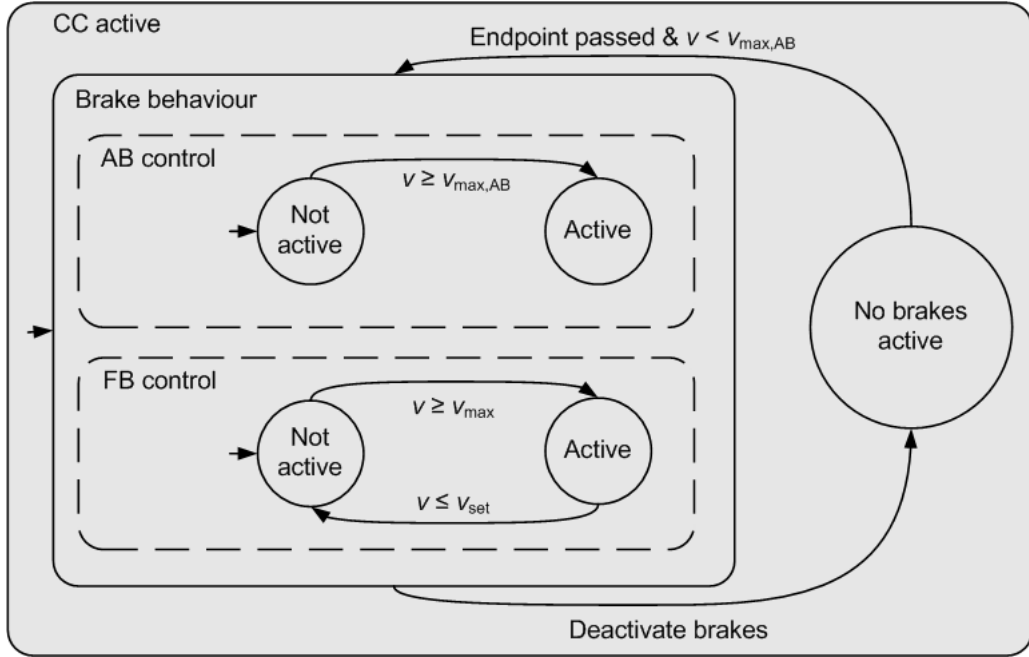

Figure 6.3: State flow showing the brake behavior of the CC.

point has been found, a simulation using the vehicle model described in Equation 3.7 is performed in the same way as explained in Section 6.1. If so, the point is established as p_{end} at a distance ahead of the current vehicle position, s_{end} . If not, the algorithm continues to search for p_{end} .

When s_{end} has been found, \hat{v}_{end} is estimated in the same way as explained for \hat{v}_{start} in Section 6.2. Once $\hat{v}_{\text{end}} < v_{\text{max}}$, the brakes are instantly deactivated. Until then, the brake behavior continues according to Figure 6.3. The algorithm runs the simulation in every sample point until the brake deactivation criterion has been met.

6.3.3 Brake disc temperature estimation

It is important to monitor the brake disc temperature in order to avoid overheating the brake discs. An estimate of the current temperature, T_0 , is received via the vehicle CAN network.

In order to decide whether a stationary speed should be used, an estimation of the temperature at the end of the slope, \hat{T}_{endFB} , is calculated. The FB in the subscript is used to separate this end point, p_{endFB} , from p_{end} described earlier. In this case, the end point is defined as the point from which the FBs do not have to be used any further. A point where this is true is obtained when

$$F_{\text{g,long}} < F_{\text{air}} + F_{\text{roll}} + F_{\text{eng}} + F_{\text{AB}} \quad (6.5)$$

where

$$F_{AB} = \tau_{AB} \frac{N_G N_F}{R} \quad (6.6)$$

and τ_{AB} is the torque generated by the ABs. The algorithm uses not only one point, but an average slope over a number of measurements extending over a distance, to find p_{endFB} . In order to estimate \hat{T}_{endFB} , the behavior of the last brake pulse is used. Therefore, an estimate is only available if p_{endFB} has been found and one brake pulse has been completed. In Figure 6.4, the graphical behavior of the brake cycle is shown. From the graph, the time when the FBs are applied can be calculated according to

$$t_{\text{FB}} = t_2 - t_1, \quad (6.7)$$

and the time when the brakes are not applied according to

$$t_{\text{NoFB}} = t_3 - t_2 \quad (6.8)$$

where t_1 , t_2 and t_3 are defined in the figure. The temperature derivatives during the time periods are given by

$$\dot{T}_{\text{FB}} = \frac{T_2 - T_1}{t_{\text{FB}}} \quad (6.9)$$

and

$$\dot{T}_{\text{NoFB}} = \frac{T_3 - T_2}{t_{\text{NoFB}}} \quad (6.10)$$

with T_1 , T_2 and T_3 according to Figure 6.4. Using this data, the temperature change during one brake cycle can be calculated. In order to estimate \hat{T}_{endFB} , the total number of brake cycles left in the slope must first be estimated. Assuming constant acceleration, first between t_1 and t_2 , and then between t_2 and t_3 , the average speed of the FB pulse, \bar{v}_{FB} , is given by

$$\bar{v}_{\text{FB}} = \frac{(v_{\text{max}} + v_{\text{set}})t_{\text{FB}} + (v_{\text{set}} + v_{\text{max}})t_{\text{NoFB}}}{2(t_{\text{FB}} + t_{\text{NoFB}})} = \frac{v_{\text{set}} + v_{\text{max}}}{2}. \quad (6.11)$$

The average speed in the slope, up to p_{endFB} is estimated as $\bar{v}_{\text{endFB}} = \bar{v}_{\text{FB}}$. Note that this assumes that the number of remaining brake pulses in the slope is an integer. All other cases will yield a small error in the velocity estimation.

The estimate of the total time left in the slope \hat{t}_{endFB} , is given by

$$\hat{t}_{\text{endFB}} = \frac{s_{\text{endFB}}}{\bar{v}_{\text{endFB}}}. \quad (6.12)$$

The temperature estimate is then given by

$$\hat{T}_{\text{endFB}} = T_0 + \frac{\hat{t}_{\text{endFB}}}{t_{\text{FB}} + t_{\text{NoFB}}} (t_{\text{FB}} \dot{T}_{\text{FB}} + t_{\text{NoFB}} \dot{T}_{\text{NoFB}}). \quad (6.13)$$

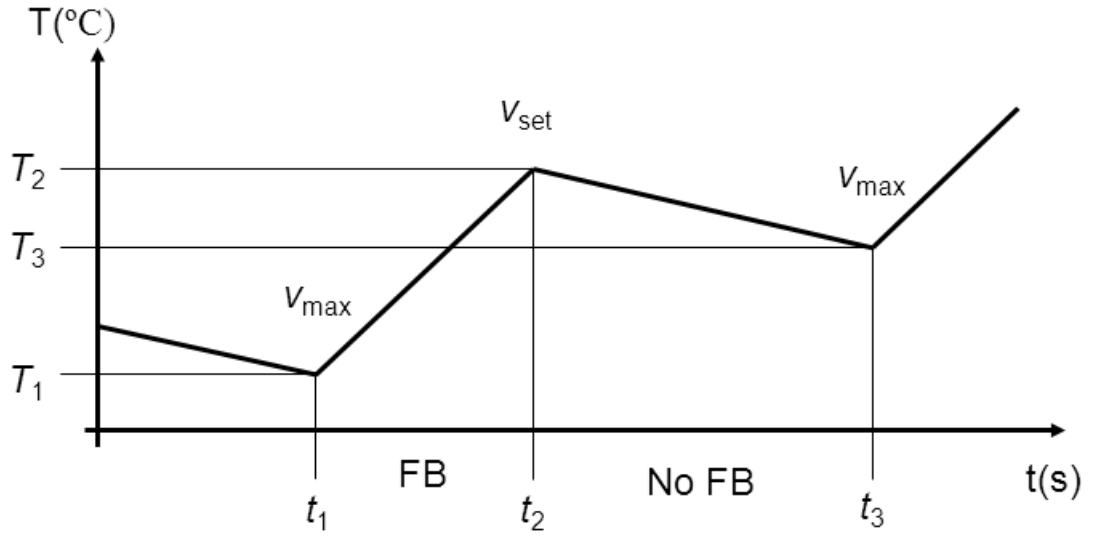

Figure 6.4: Graphical temperature behavior when using FBs.

Figure 6.5 describes how \hat{T}_{endFB} is used to decide if $v_{\text{semi-stat}}$ is necessary. When the temperature reaches T_{warn} , \hat{T}_{endFB} is compared to T_{crit} . If $\hat{T}_{\text{endFB}} > T_{\text{crit}}$ or if \hat{T}_{endFB} is not available, the set speed is changed to $v_{\text{semi-stat}}$. However, if $\hat{T}_{\text{endFB}} \leq T_{\text{crit}}$, setting the speed to $v_{\text{semi-stat}}$ can be avoided since the temperature will not reach T_{crit} during the slope.

6.3.4 Stationary speed calculation

One way to avoid acceleration in a downhill slope is to lower the speed and, in addition, lower the gear. Doing so will increase the braking torque generated by the ABs. The resistance force can be increased further by increasing the engine speed to a maximum acceptable value, $\omega_{\text{eng,max}}$. This engine speed can be requested through the BC functionality. The brake force needed for the speed to be stationary can be determined from the inequality

$$F_{\text{AB}} \geq F_{\text{g,long}} - F_{\text{air}} - F_{\text{roll}} - F_{\text{eng}} \quad (6.14)$$

implying that

$$\tau_{\text{AB}} \frac{N_{\text{G}}N_{\text{F}}}{R} \geq mg \sin \alpha_{\text{max}} - \frac{C_{\text{d}}A\rho}{2}v_{\text{stat}}^2 + C_{\text{roll}}mg \cos \alpha_{\text{max}} + f(\omega_{\text{eng}}) \frac{N_{\text{G}}N_{\text{F}}}{R} \quad (6.15)$$

where α_{max} is the maximum slope. Since $\omega_{\text{eng}} = \omega_{\text{eng,max}}$ is known, the stationary speed can be expressed as

$$v_{\text{stat}} = \frac{\omega_{\text{eng,max}}}{N_{\text{G}}N_{\text{F}}}R. \quad (6.16)$$

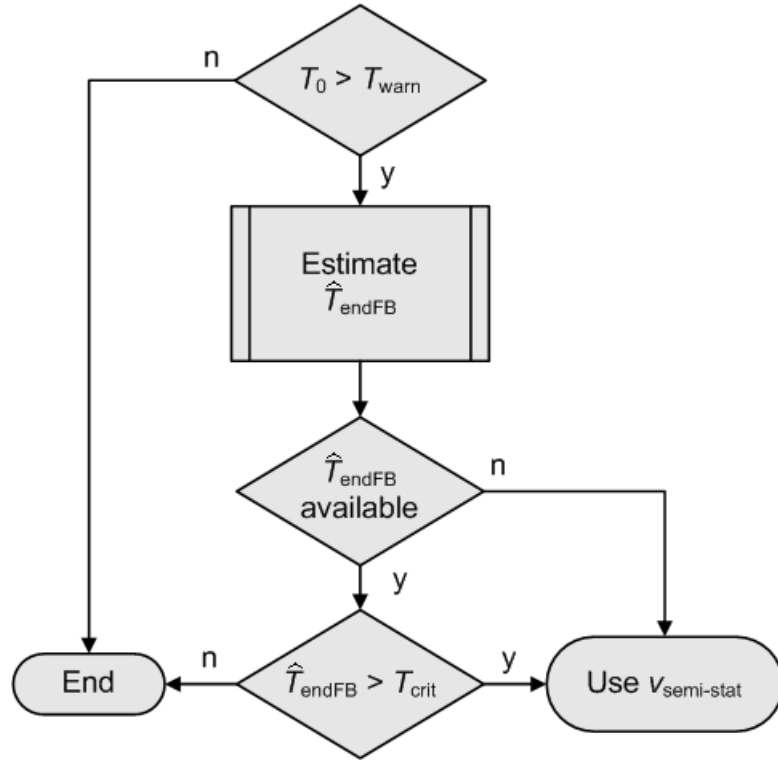

Figure 6.5: Flow chart describing the stationary speed decision algorithm.

This reduces the number of variables in Equation 6.15 to one, N_G . v_{stat} can be calculated when the highest gear, that is, lowest gear ratio, ($N_{G,\text{stat}}$), that satisfies the equation has been found. It is given by

$$N_{G,\text{stat}} = \min_{N_G} (F_{\text{AB}} \geq F_{\text{g,long}} - F_{\text{air}} - F_{\text{roll}} - F_{\text{eng}}). \quad (6.17)$$

In order to avoid too low average speed, $v_{\text{semi-stat}}$ is used instead of v_{stat} . The semi-stationary speed is given by

$$v_{\text{semi-stat}} = v_{\text{stat}} + \Delta v_{\text{stat}} \quad (6.18)$$

where Δv_{stat} is a speed threshold which will allow some acceleration.

Chapter 7

System evaluation

The performance of the algorithm was evaluated in both a simulated environment and in real vehicle tests. In simulations, the potential brake behavior improvement compared to the CC-FB was evaluated. Real vehicle tests were used to verify that the function works according to the description in Section 5.2.

The test runs, both in simulations and in the real vehicle, were carried out on two Swedish roads, namely Road 40 between Landvetter and Kallebäck, and Road E6 between Halmstad and Ängelholm. These roads were chosen since they include suitable slopes.

7.1 Simulated vehicle tests

For the simulations, the simple longitudinal vehicle model, described in Section 3, was used. A simple speed controller and a FB controller was implemented from which the tested CC could request engine and brake torque. Furthermore, a VEB with the torque map presented in [1] was used. The Simulink model is shown in Figure 7.1.

It should be noted that the vehicle model used is the same as the one used by the CC-FBp algorithm. Therefore, the algorithm will behave in an optimal way in each scenario. In reality, model errors and factors that are not modelled such as, for example, wind, will affect the outcome to some degree.

7.1.1 Brake behavior for CC-FBp

It was first investigated how different variables affect the brake energy distribution ratio between the FBs and ABs. The FB ratio is calculated as the energy absorbed by the FBs divided with the total amount of energy absorbed by the braking systems. In the simulations, a number of variables were varied, namely N_G (gear), ω_{eng} , $v_{\text{set}} - v_{\text{min}}$, and $v_{\text{max}} - v_{\text{set}}$. During the tests of one variable, the remaining three were kept constant.

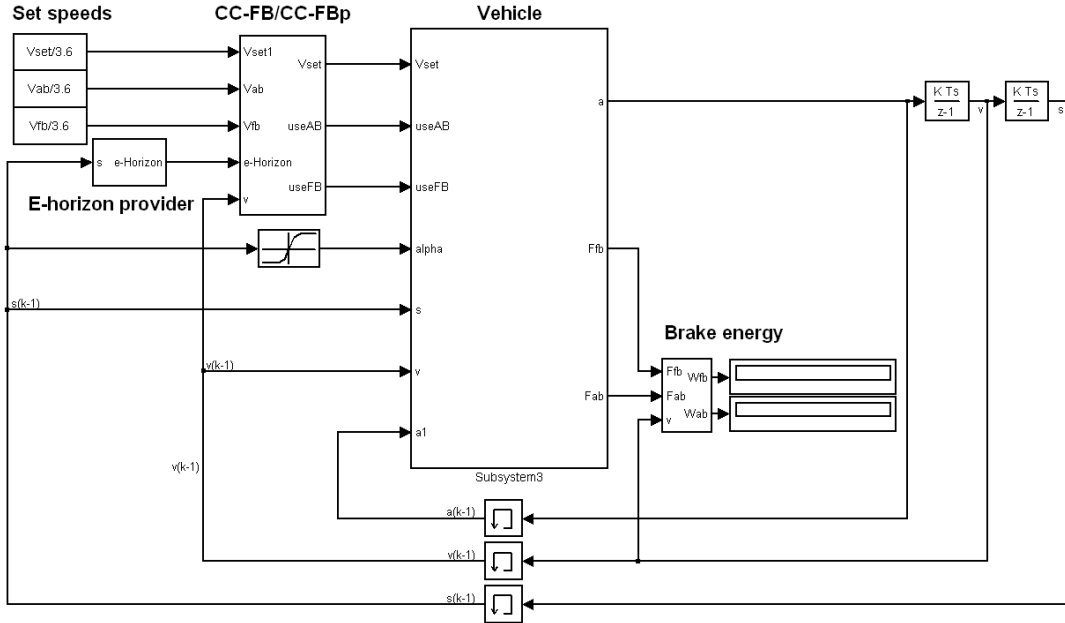

Figure 7.1: Simulation environment. The environment contains the vehicle, the E-horizon provider, and the evaluated algorithm. The work performed by the different brake systems is continuously measured.

The results from the tests are shown in Figure 7.2. From the figure, it is evident that the variable influencing the FB energy absorption ratio the most, is the selected gear. The engine speed affects the ratio to a small degree while the effects from the different speed intervals are negligible.

It should be pointed out that changing the variables does not only affect the FB ratio but also the average speed for the slope. If, for example, the gear is lowered while ω_{eng} is kept constant, the average speed is consequently lowered. In reality, to get a high utilization rate of the FBs, the gear should be lowered and the engine speed increased.

7.1.2 Comparison between CC-FBp and CC-FB

Simulations were made to compare the FB utilization rate between the CC-FBp and the CC-FB using both Road 40 and Road E6. It has been shown that the main variable affecting the FB ratio is the gear. Therefore, only the gear was varied during the tests.

In Figure 7.3, the FB ratios of the two CCs are compared. As seen, the CC-FBp needs to utilize the FBs less than the CC-FB. It can also be seen that the utilization rate differ between the two slopes. The FB ratio for the CC-FBp will always be less or equal to the CC-FB. It will be equal in slopes where only the ABs are needed or where

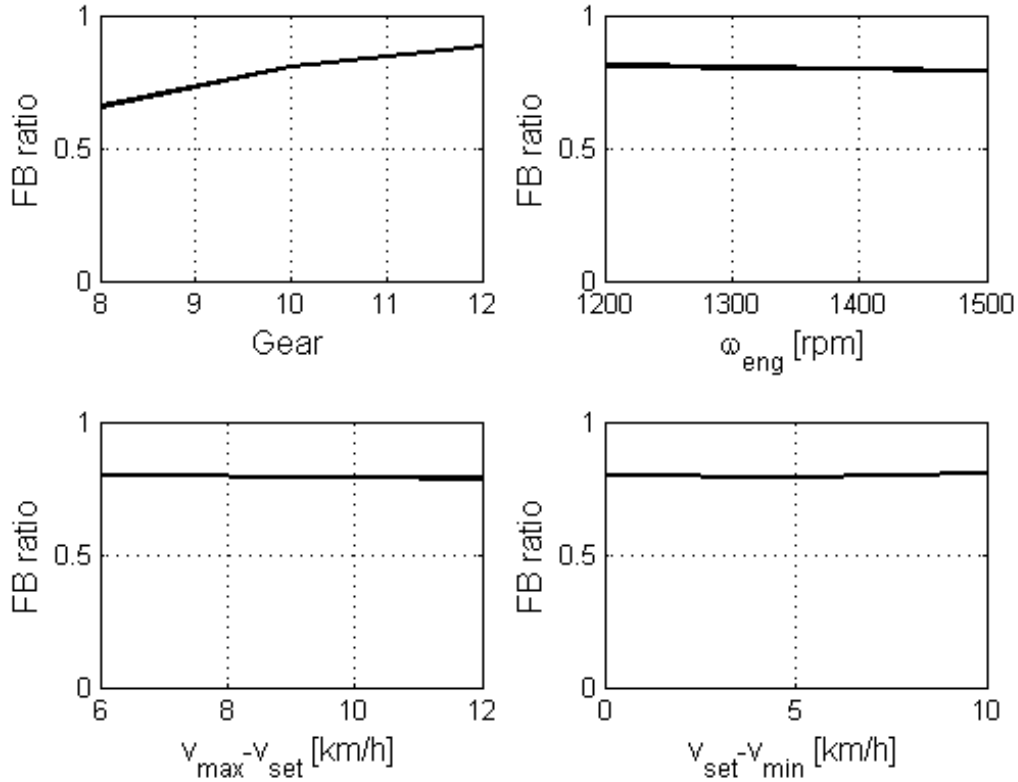

Figure 7.2: FB energy for a drive through the Road 40 slope. The FB ratio is reduced when the gear is lowered. For the other variables, the ratio is influenced to a very low degree.

one FB pulse is enough. In all longer and steeper slopes, it will be smaller. However, as seen in the figure, how much smaller depends on the specific slope and its features.

The average speed is measured from the point where the speed reduction starts for the CC-FBp, to the point where the speed has reduced down to set speed after the slope. It is almost equal for the two controllers, even though the CC-FBp allows the speed to reduce before the slope and therefore is more fuel efficient.

Figure 7.4 shows the ratio between the energy absorbed by the FBs in the CC-FBp and the energy absorbed in the CC-FB for the two scenarios. It can be seen that the ratio varies to some degree for the different slopes. At Road E6, the average reduction in the energy absorbed by the FBs was 7.2% while the reduction in average speed was 1.61% (1.15 km/h)¹. The corresponding numbers for Road 40 were 10.4% and 0.37% (0.16 km/h).

¹The CC-FB broke the speed conditions in a number of test runs for both slopes. Those occasions have not been included in the calculation of the average speed.

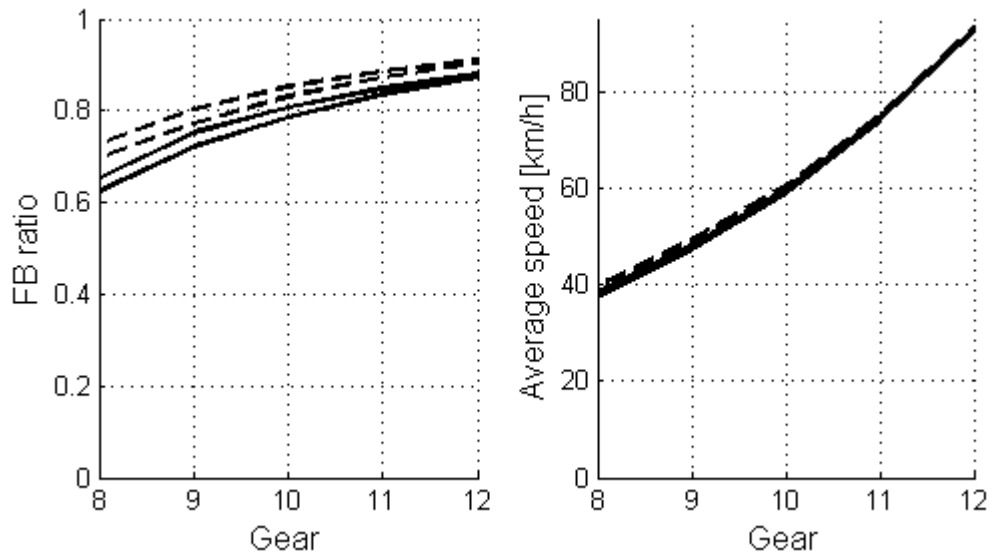

Figure 7.3: FB ratio and average speed. The solid lines represent tests with the CC-FBp while the dashed lines represent tests with the CC-FB. As seen, the FB utilization rate is lower for the CC-FBp. Despite the speed reduction before the slope allowed by the CC-FBp, the average speed is only affected to a small degree since the CC-FB seldom achieves the maximum speed at the end of the slope. The problem with reaching the maximum speed, using the CC-FB, is due to the problem with accurately finding the end of the slope without using information about the road ahead.

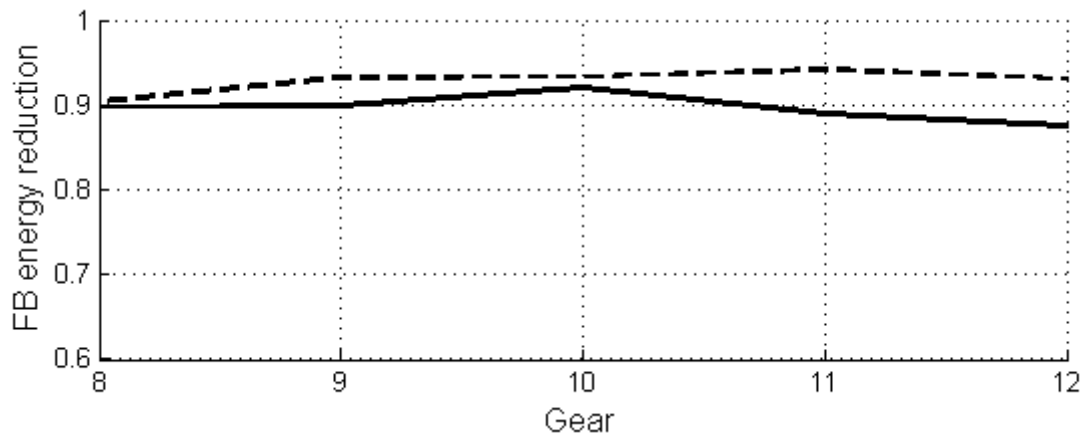

Figure 7.4: The reduction in energy absorbed by the FBs when using CC-FBp compared to CC-FB. The solid line represents the simulation with Road 40 while the dashed line represents the simulation using Road E6. It can be seen that there is a reduction in the energy amount absorbed by the FBs with between 6-13%.



Figure 7.5: Test truck used for the in vehicle testing.

7.2 Real vehicle tests

All tests were performed in a Volvo FH12 with a semi-trailer and a total weight of about 40,000 kg, shown in Figure 7.5. The truck was equipped with the hardware shown in Figure 5.1. This includes a GPS receiver, the E-horizon provider, and the RPC unit where the function is running.

In total, almost 60 test runs were carried out during different stages of the project. The results presented here show the performance of the final version of the algorithm.

7.2.1 Downhill driving

When driving in *find slope*, the algorithm keeps the vehicle speed constant at v_{set} while continuously searching for a start point of a downhill slope. The performance of the algorithm when approaching a slope is shown in Figure 7.6. As seen, the slope is detected and the speed is allowed to drop to v_{min} just before entering the slope.

When the vehicle has entered the slope, the speed increases and the brakes must be applied. Figure 7.7 shows the brake behavior during the slope as well as the deactivation of the brakes. The ABs are continuously applied while the FBs are used for short

periods of time when the speed reaches v_{\max} . The vehicle leaves the slope at a speed close to the maximum allowed velocity. As can be seen, the speed profile looks like the desired profile described in Section 5.2.

7.2.2 Temperature estimation and stationary speed

When driving in a slope, the temperature at the end of the slope is continuously estimated. This is needed to avoid sudden brake capacity reduction and brake wear. The performance of the temperature estimator is shown in Figure 7.8. As is shown in the figure, the temperature becomes available after one brake cycle has been completed. The estimate is used in the decision making regarding semi-stationary speed.

Figures 7.9 and 7.10 show the behavior when the temperature reaches the warning level. The first figure shows a case in which no estimate of the brake temperature is available and stationary speed must be used. The second figure shows a scenario in which an estimate is available when T_{warn} is reached. Since the estimate is below T_{crit} , the speed reduction can be avoided. The temperature of the disc brakes never exceeds the critical temperature in any of the scenarios. Moreover, it can be seen that reached maximum temperature is close to the estimate. The functionality is as described in Section 5.2.

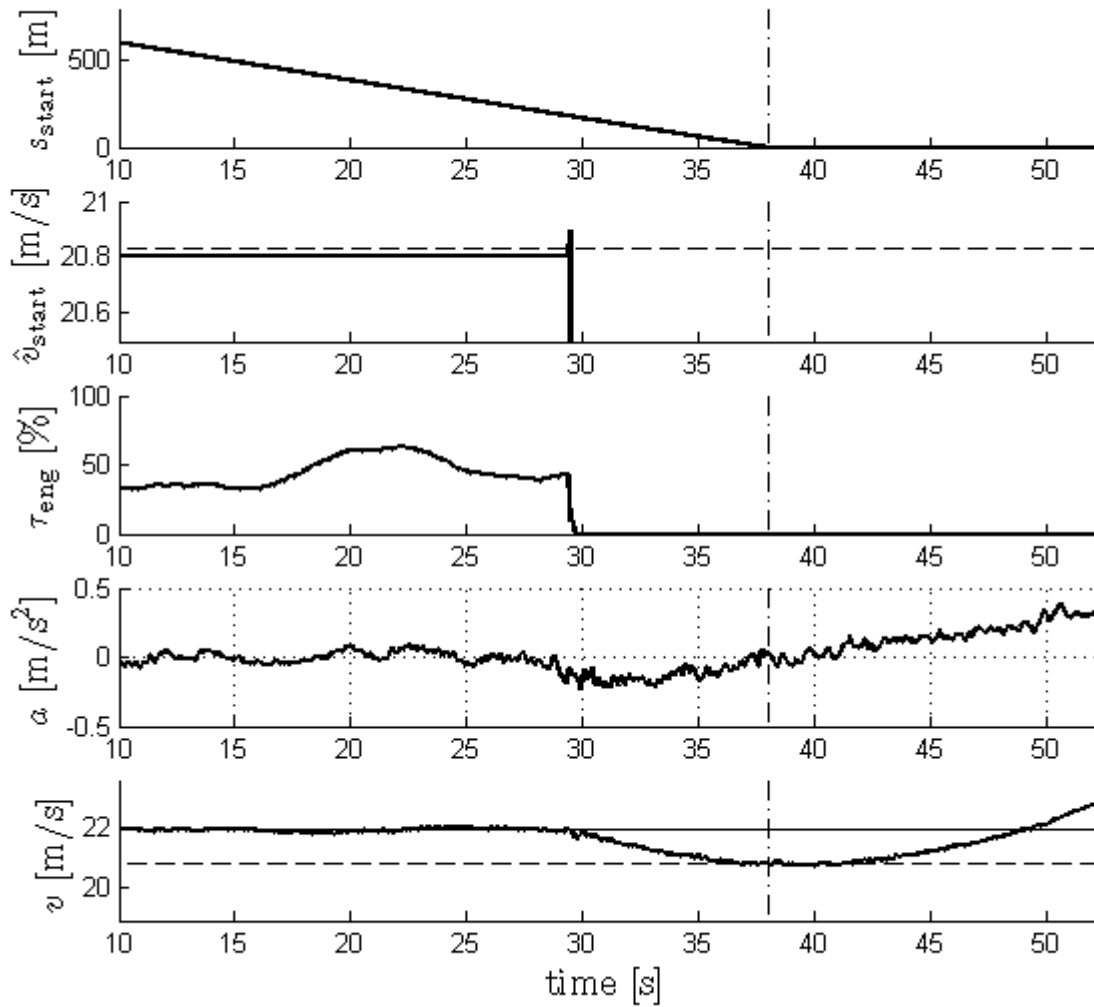

Figure 7.6: Vehicle approaching a downhill slope. The thin solid line represents v_{set} , the thin dashed line v_{min} , and the thin dot-dashed line p_{start} . Since a start point has been found, \hat{v}_{start} is estimated. The calculation of the estimation in every sample is cancelled as soon as the estimate becomes smaller than v_{min} . At $t = 29$ s, \hat{v}_{start} becomes greater than v_{min} and the engine torque is deactivated. Due to the resistance forces, the acceleration becomes negative. This leads to a speed reduction and, approximately at p_{start} , the speed reaches v_{min} . After p_{start} , the speed increases due to gravity.

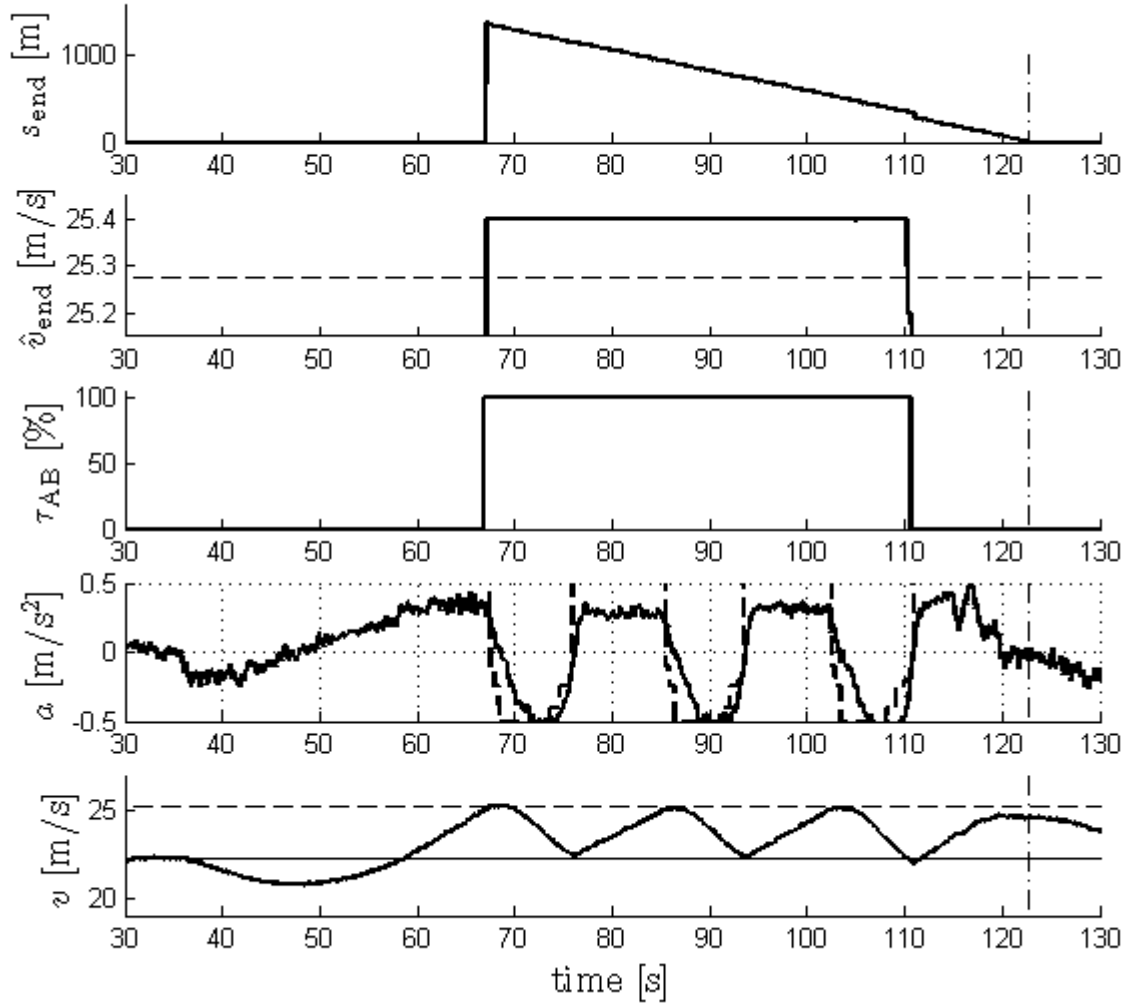

Figure 7.7: Vehicle driving in a downhill slope. The thin solid line represents v_{set} , the thin dashed line v_{max} , the thin dot-dashed line p_{end} , and the thick dashed line the FB acceleration request. After the speed reduction, the speed increases to $v_{\text{max,AB}}$. At this point, the ABs are activated and soon after, the FBs as well. During the brake pulse, the speed is reduced down to v_{set} . The braking cycles continue down the whole slope. Early in the slope, the end point is detected. At this time, v_{set} is estimated and as soon as the estimate is lower than v_{max} , the brakes are deactivated. This leads to positive acceleration which results in the speed reaching a maximum value close to v_{max} , at approximately the found end point.

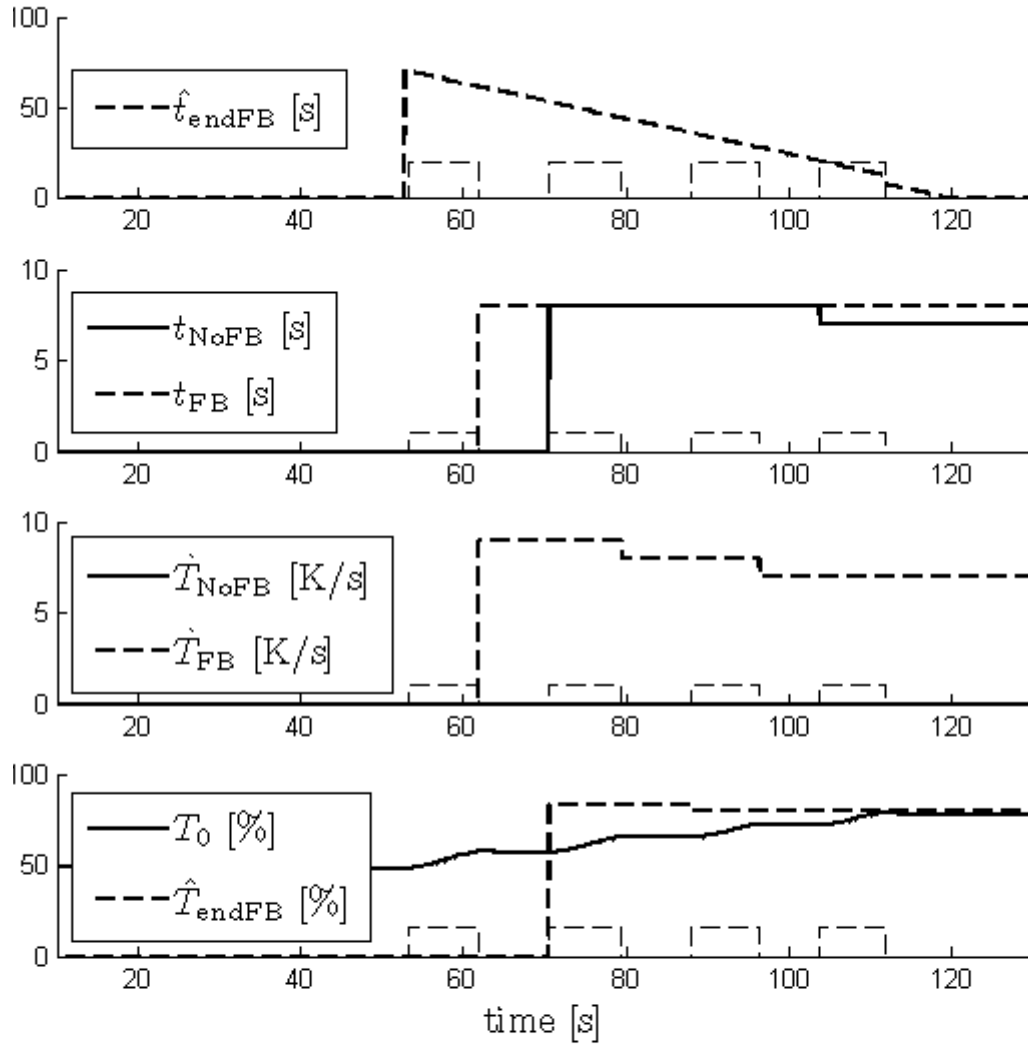

Figure 7.8: Temperature estimation in downhill slope. The thin dashed line indicates where the FBs are applied. As soon as p_{endFB} has been found, \hat{t}_{endFB} can be calculated. After the first FB pulse, t_{NoFB} and \dot{T}_{NoFB} become available. t_{FB} and \dot{T}_{FB} become available after the first brake cycle has been completed at $t = 70$ s. At this time, \hat{T}_{endFB} can be calculated. As shown, the estimate is updated with new information after each completed brake cycle. The estimate is close to the maximum temperature reached at the end of the slope.

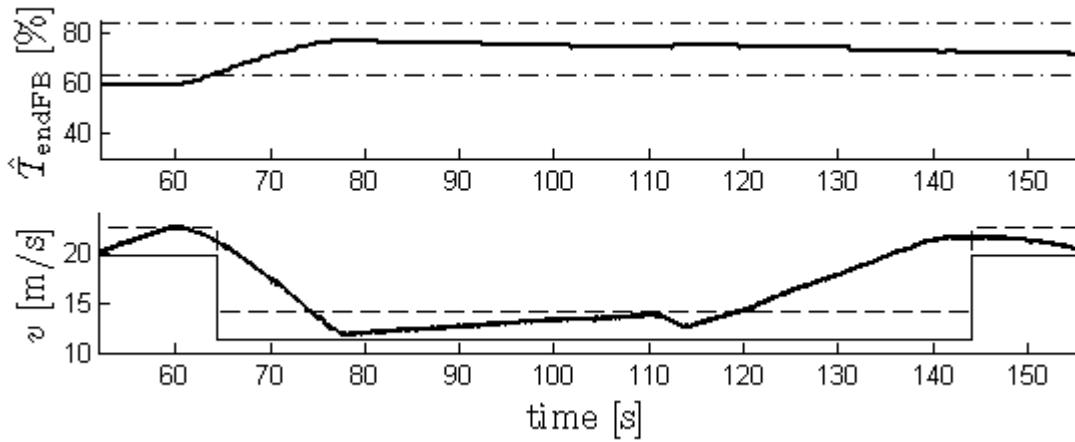

Figure 7.9: Stationary speed in downhill driving. The thin solid line represents v_{set} , the thin dashed line v_{max} , and the thin dot-dashed lines T_{warn} and T_{crit} . During the first brake pulse, at $t = 63$ s, the temperature of the brake discs reaches T_{warn} . At this time, T_{endFB} is not available since no brake cycle has been completed. Therefore, the velocity is reduced to semi-stationary speed by a long FB pulse. At the lower speed, the vehicle still accelerates but at a much lower rate than before. As a result, the utilization rate of the FBs is heavily reduced. At $t=114$ s, the brakes are deactivated and the speed begins to increase. The speed profile shows that v_{max} is almost reached at p_{end} . During the slope, the temperature does not reach T_{crit} .

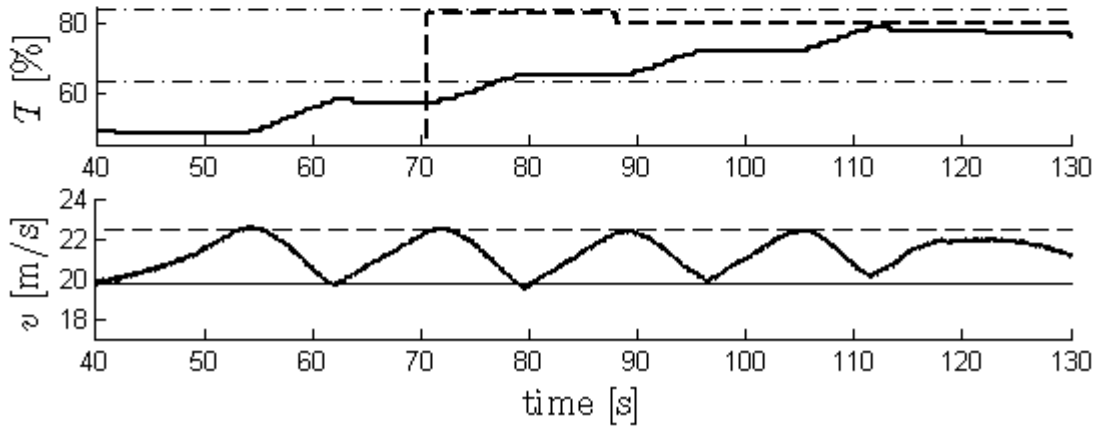

Figure 7.10: Avoiding stationary speed in a slope. The thin solid line represents v_{set} , the thin dashed line v_{max} and the thin dot-dashed lines T_{warn} and T_{crit} . At $t = 77$ s, the temperature reaches T_{warn} . However, since \hat{T}_{endFB} (thick dashed line) is available and lower than T_{crit} , $v_{\text{semi-stat}}$ is avoided.

Chapter 8

Discussion

In this thesis, a CC algorithm that imitates the desired behavior of a truck driver in downhill driving has been implemented. Since some of the components could have been implemented in a different way, some possible alternatives are discussed here.

In the developed algorithm, the speed is only allowed to decrease before a downhill slope if the descent contains enough potential energy to bring the speed from the minimum to the set speed. It would be possible to achieve further fuel savings if utilizing the energy also in smaller slopes. However, this would lead to a decreased average travel speed. It was decided to only use bigger slopes to prove the concept.

It would be beneficial to make the last brake pulse in the slope more adaptive. As implemented now, the algorithm can possibly apply a short brake pulse in the end of a slope. This would feel strange to the driver and should preferably be avoided. One way of handling the problem would be to allow the last brake pulse to reduce the speed further than to the set speed. For example, a reduction to the minimum speed could be tolerated if it would lead to avoiding an additional brake pulse. This approach would require a more thorough investigation of the remaining slope when the FBs are applied.

The way the system handles slopes where stationary speed is needed could be implemented in different ways. In the current implementation, the set speed is held for as long as possible and then reduced to semi-stationary speed. One way to avoid the very low semi-stationary speed would be to analyse the whole slope when the vehicle is approaching. This would make it possible to choose a set speed which is suitable to maintain during the whole slope. This speed would be lower than the original set speed but would not have to be reduced during the slope. This approach would require a very long E-horizon. Therefore, the current implementation was chosen.

The temperature estimator worked well in the tested scenarios. However, as implemented right now, the estimate is based on the last brake cycle. Therefore, any changes in the shape of the remaining slope is not reflected in the estimate. It would be possible to use the slope information about the road ahead to improve the estimate. However, the gain in accuracy compared to the cost in complexity could be questioned.

Chapter 9

Conclusion

In this work, a heavy vehicle cruise control using FBs has been improved by integrating preview information about the road ahead. The goal with the function, namely for the cruise control behavior to resemble that of an experienced driver when driving down a slope, has been achieved.

Before entering a slope, the speed is allowed to decrease down to a pre-defined minimum speed. Therefore, the engine torque can be deactivated when approaching a descent. When this is done, the negative acceleration generated by the resistance forces affecting the truck leads to a speed reduction. The set speed is regained once the vehicle is in the slope.

In a slope, if the speed reaches a pre-defined speed, the ABs are applied. If the speed continues to increase up to a maximum defined speed, the FBs are activated and brakes the speed down to the set speed. For as long as the vehicle is in the slope, the vehicle will continue to accelerate and the brake cycle behavior is repeated if needed. The system ensures leaving the slope at a predefined maximum speed by deactivation of the brakes before the slope ends.

In order to protect the brakes and to ensure safety, the temperature of the brake discs is continuously monitored. If it reaches a defined threshold, an estimation of the temperature in the end of the slope is calculated using the preview data. If the estimated temperature is greater than a pre-defined critical brake disc temperature, the speed is reduced to stationary speed so that the utilization of the FBs can be reduced.

The goal to assimilate as much energy as possible is achieved by using the minimum allowed speed when entering, and maximum speed when exiting, the slope. At the same time, the brake wear is reduced since the ABs are continuously used through the slope. This leads to less usage of the FBs compared to the existing CC-FB. It has been shown in simulations that, on average, brake usage is reduced by 10.4% and 7.2% for two specific slopes. This is achieved with only minor effects on the average speed. In the two cases, it was reduced by 0.37% and 1.61% respectively.

Bibliography

- [1] N. CARLSSON, H. GLAD, *Cruise Controller With Temperature Controlled Foundation Brakes*, Department of Machine and Vehicle Systems, Chalmers University of Technology, 2005.
- [2] P. LINGMAN, *Integrated Brake Control - downhill driving strategies*, Chalmers University of Technology, 2006.
- [3] K. NEISS, S. TERWEN, T. CONNOLLY, *Predictive Speed Control For A Motor Vehicle*, DaimlerChrysler AG, 2006.
- [4] E. HELLSTRÖM, *Explicit Use Of Road Topography For Model Predictive Cruise Control In Heavy Trucks*, Department of Electrical Engineering, Linköping University of Technology, 2005.
- [5] E. KOZICA, *Look Ahead Cruise Control: Road Slope Estimation And Control Sensitivity*, Royal Institute of Technology, Department of Signals, Sensors and Systems, 2005.
- [6] P. LINGMAN, M. WAHDE, *Integrated Retardation Control Using Neural Networks With Genetic Algorithms*, Department of Machine and Vehicle Systems, Chalmers University of Technology, 2002.
- [7] B. FRANZON, private communication, 2011-12-13.
- [8] M. NYMAN, private communication, 2011-12-16.
- [9] O. JOHANSSON, private communication, 2012-01-12.
- [10] S. JAKOBSSON, N. JOHANSSON, O. KLINTENBERG, *Preview-Information-based Transmission Functions for Improved Fuel Economy in Heavy Trucks*, Chalmers University of Technology, Department of Signals and Systems, 2008.
- [11] P. MISRA, B.P. BURKE, M.M. PRATT, *GPS Performance in Navigation*, Lincoln Lab., MIT, Lexington, 1999.