

CHALMERS



Analyses of acrylic acid, phosphoric acid and 2-ethylhexylamine in surfactant with capillary electrophoresis - possibility for further method development in quality control.

Thesis for Bachelor of Science in Chemical Engineering

Napaporn Larsson

Department of Organic chemistry

CHALMERS UNIVERSITY OF TECHNOLOGY

Gothenburg, Sweden 2012

Report no. 2012:004

**Analyses of acrylic acid, phosphoric acid and
2-ethylhexylamine in surfactant with capillary
electrophoresis** - possibility for further method development
for quality control.

Napaporn Larsson

© Napaporn Larsson, 2012

Department of Organic chemistry
Chalmers University of Technology
SE-412 96 Gothenburg, Sweden
Telephone + 46 (0)31-772 1000

Chalmers University of Technology
Gothenburg, Sweden 2012

Report no. 2012:004

Abstract

Capillary electrophoresis (CE) possibility for detection and separation of Acrylic acid (AA), Phosphoric acid (PA), and 2-Ethylhexylamine (2-EHA) in surfactant product was investigated. Objective of the report was to determine if CE can become a beneficial alternative method for analyses of the three substances. Result indicates that all three compounds are detectable with CE system, AA was detectable within 4 min, PA within 6 min and 2-EHA within 2 min runtime using BGE: phthalic acid solution with EDTA additive adjusted to 9,1 pH with diethanolamin. Fused silica capillary of 50 μm i.d. and 50 cm long (41,5 effective length). Both injection modes were EKI and HDI was tested, HDI was used for all type of analyses and EKI can improve 2-EHA detection signal. Linear calibration curve was obtainable for all analytes. The result obtained from the analyses was compared with other analytical method. Further investigations and research are needed in order to develop a reliable and fully functional CE-method. Information on further work indicates that CE wide range and time optimizing system can become useful and powerful method for both R&D department and PQC department in Stenungsund.

Table of Contents

1.	Introduction	1
1.1	Objective	1
2.	Background	3
2.1.	Capillary electrophoreses (CE)	3
2.1.1.	CE separation principle	5
2.2	Separation modes in CE	7
2.2.1	Capillary zone electrophoresis	7
2.2.2	Micellarelectrokinetic chromatography	8
2.2.3	Capillary gel electrophoresis	9
2.2.4	Capillary isoelectric focusing	9
2.2.5.	Capillary isotachopheresis	10
2.3.	Surfactants	11
2.3.1.	Anionic surfactant	13
2.3.2.	Cationic surfactants	13
2.3.3.	Nonionic surfactants	13
2.3.4.	Amphoteric surfactants	13
2.4.	Surfactants products analyze with CE system?.....	14
3.	Experiment.....	16
3.1.	Equipment and settings	16
3.2.	Standard solutions	18
3.3.	Test sample	19
4.	Result and discussion	22
4.1.	Phosphate result	22
4.2.	Acrylic acid result	25
4.3.	2- Ethylhexylamine result	27
4.4.	Result of acrylic acid and 2- ethylhexylamine mixture	32
5.	Conclusion.....	34
6.	Further work and improvement	36
6.1.	Suggestion in improving phosphoric acid analyses with CE	36
6.2.	Suggestion in improving 2-Ethylhexylamine analyses with CE	36

6.3.	Surfactants analyses with CE	36
6.4.	Dimethylamine analyses with CE	37
6.5.	Potassium and sodium analyses with CE	38
6.6.	Nitrate and nitrite with CE	38
7.	Acknowledgment	39
8.	Abbreviations	40
9.	Referents	41
	Appendix 1: Buffer for HPCE	44
	Appendix 2: Buffers additive	45
	Appendix 3: Surfactant use in MEKC mode	46
	Appendix 4: Phosphate calibration curve	47
	Appendix 5: Acrylic acid calibration curve	48
	Appendix 6: 2-ethylhexylamine calibration curve from insoluble stock solution.	49
	Appendix 7: 2-ethylhexylamine calibration curve from soluble stock solution.	50

1. Introduction

Akzo Nobel surface chemistry is a global company. The surfactants production site in Sweden is in Stenungsund and Sundsvall which produces surfactants applies in asphalt, hygiene, paint and agrochemicals. The surfactants properties must meet the customer delivery conditions without compromising the quality of the product. There is always need for a faster and reliable quality control process therefore it is necessary to develop a new method for analyses.

Capillary electrophoresis system is a new technology to the R&D department in Stenungsund it's not as well developed and established compare to e.g. liquid chromatography (LC) and gas chromatography (GC). The result in the report will be based on the laboratory experiments conducted in Deventer.

The possibility of CE is being an alternative/addition method for quality control analyses will be investigated. Analyses of substances such as acrylic acid, phosphoric acid and 2-ethylhexylamine is a time consuming process using the existing method therefore the possibility of analyses with CE and the beneficial factors will be studied. CE result will be compared to other analytical methods use in quality control. The experiments will determent the possibility of CEs further development, beneficial factor, and application possibility in R&D and PQC department.

Basics of CE principle and separation modes and short information about the surfactants are covered in this report and possibility for further development and suggestion of analyses of other "CE suitable" compounds will be discussed.

1.1 Objective

The purpose with the experiment is to determine if CE system is suitable for quantitative and qualitative analyses of acrylic acid (AA), phosphoric acid (PA) and 2-ethylhexylamine (2-EHA) in two surfactant product, both AA and 2-EHA in Ampholak YJH 40 and PA in Phospholan PE 65. The existing analytical method in Akzo Nobel quality control is time consuming and involves several practical steps in sample preparation before the sample is ready for analyze.

The method use to determent PA in Phospholan PE 65 consists of hydrolysis process which takes approximately two hours to perform. The Hydrolyzed sample also need further pretreatment before it's ready to be analyze with UV-spectrometer. The whole process of analyzing PA in Phospholan PE 56 takes approximately three hours to complete. Note that the results differ dependent on the waiting time before analyses take place (it's part of the pretreatment process to wait 20 min before analyze). Development of an alternative method will be beneficial for determination of PA in Phospholan PE 65.

Both substances (AA and 2-EHA) in Ampholak YJH 40 can be determined using HPLC, though it's the same system and same detector there are a few adjustments in the instrument that's has to be done in order to switch between analysis. They both need different column, mobile phase and settings plus the pretreatment process are different for both analytes. Loading a new method takes at least an hour hence the system need to be activated one hour before its ready for use. An AA analysis with HPLC is a simple method, the product is diluted in the mobile solution before run, while 2-EHA is a more time consuming process. It includes the derivatization in the pretreatment process, which demands fresh solutions. The time needed to analyze both species takes approximately four to five hours in total. This includes the time for system activation, run time and sample preparations time.

There was a need to develop a simpler and less time consuming method for the quality control laboratory (QCL). In Akzo Nobel production site numerous products is produced, sometime in a tight schedule especially if there were delayed or complication in the production process which leaves less or not time for laboratory engineer to complete the analyses in time. This in turn, leads to delays in delivery process.

CE was highlighted as an optional method by Rolf Arvidsson from the research and development (R&D) analytical department in Stenungsund. The rapid analyses time which required no pretreatment of the sample make CE an attractive method to develop and investigate further possible applications in Surfactant Stenungsund. One of the objectives of this experiment is to analyses both species (AA and 2-EHA) in one run using CE system, which will save time and lower the workload in sample preparation. The result from CE method will be compared with an existing method that the QCL are using in determination of AA, PA and 2-EHA. The possibility for method improvement and suggestion of further application of CE are also including in this report.

2. Background

2.1. Capillary electrophoresis (CE)

In 1937 a Swedish docent name Arne Wilhelm Kaurin Tiselius (Nobelprize.org, 1948) introduced electrophoresis as a separation technique and was later on awarded with a Nobel Prize for his work in separation science. The development of CE has comes a long way since 1937 it's widely use in the biological field. Beside the use in the pharmaceutical field the CEs diverse applications range makes it an attractive separation method for compounds such as surfactant, organic dyes and inorganic ions. Improvements from electrophoresis principle to a CE system are resulting in wider application range for the technique. Instead of the stab gels and flat-bed format which are mostly limited to separate macromolecules, CE format is performing chromatography in the column where the mechanisms of separation is greatly extended. Separation of cations, anions and neutrals can be done in a single analysis. (Heiger, 2000)

Electrophoresis is a separation technique, based on a differential movement of charged components (ions) in electrophoresis media inside a narrow bore capillary presented in a small sample volume. The movement effect of the ions inside the capillary is causes by attraction or repulsion in an electric field. (Heiger, 2000)

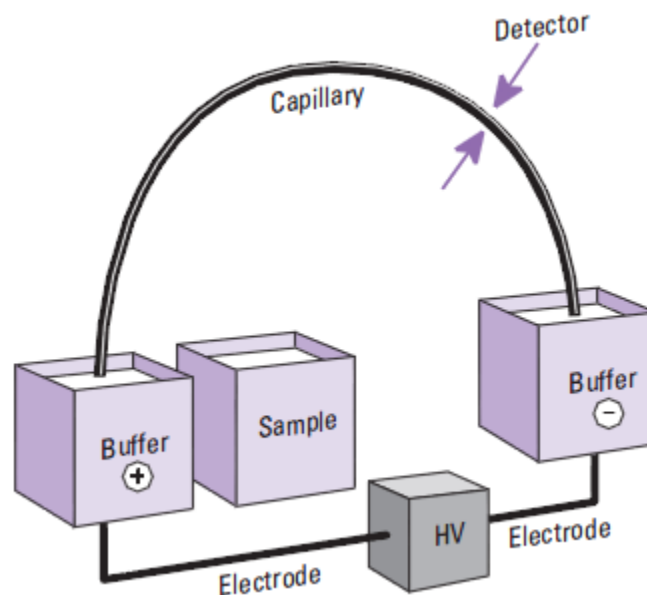

Fig. 2.1: A simplify schematic of a CE system (Heiger, 2000).

The basic principle of CE in fig. 2.1 is a simpler schematic diagram of a CE system showing the end of the capillary in contact with buffer solution. Inside the capillary is filled with the identical buffer solution. The capillary and the power supply are connected though electrodes in the

reservoirs in sample or buffer. When loading a sample into the capillary the buffer reservoir on the negative end (in most cases) is swapped from buffer to sample reservoir. Sample is injected into the capillary by application of electric field or an external pressure. After sample is injected, the electric field is applied in the capillary and the separation of the compounds starts. The separation is based on their size to charge ratio. The detector in CE is a conductivity or optical detector. (Heiger, 2000)

In CE there are two injection methods, hydrodynamic (pressure/time) and electrokinetic (voltage/time) mode. With hydrodynamic injection (HDI) mode sample is injecting into the capillary by application of pressure at the injection end of the capillary or vacuum at the exit end of capillary (Heiger, 2000). Hydrodynamic injection mode is non selective, meaning the sample composition injected into the capillary is not altered during the injection process (Tagliaro, Manetto, Crivellente, & Smith, 1998). The small volume injected into the capillary is depended on various factors, capillary dimension, buffer viscosity in the capillary, injection time, injection pressure (25 – 100mbar) and capillary temperature control. When using electrokinetic injection (EKI), voltage is applied into the sample vial and the variation in sample charge and mobility drive a selective part of the sample into the capillary. Electrokinetic injection is selecting species in the sample that contain high mobility. Therefore the ions with high mobility will be loaded in a greater amount then ions with lower mobility (Heiger, 2000).

For CE-system it's important that the capillary is resistant against chemically and physically impact, UV-visible transparent, maintain a good conductivity and inexpensive. Fused-silica capillaries meet the described requirements; therefore it's a general choice when choosing a capillary for a CE-system. Fuse-capillary typical inner diameter is 25- to 75- μm , effective length 50- to 75-cm and total length is normally 5-15 cm longer then the effective length depending on the distance from detector to the exit reservoir (Heiger, 2000).

The most commonly use detector for CE- system is UV-Visible detection. There are other choices of detector for example, fluorescence, laser induced fluorescence, amperometry, conductivity, mass spectrometry and indirect- UV. To obtain optical detectors high sensitivity and liner detection range it's important that the optical light beam is focus into the capillary and the unwanted/diffusion light minimalizes (Heiger, 2000).

In method development it's useful to use the diode-array detection (DAD) feature in CE. Application of DAD makes it possible to monitor the sample in different signals in one run. Different substances have different absorption wavelength (signal). DAD is a great tool in optimizing the peaks of the analyte. With this method it's possible to determent if the peaks are pure or contaminated, the relevant peak in the sample can also be maximize and non-relevant peaks minimize by using the optimizing wavelength that specific species responds to. (Heiger, 2000).

2.1.1. CE separation principle

Separation in CE principle is determined by the charge ions travel at different velocity depending on their mobility. Basically if two analytes obtain different mobility it can be separated by CE (Agilent Technologies, 2000).

The velocity of the ion can be calculated using equation (2.1).

$$v = \mu_e E \quad (2.1)$$

Where

v = ion velocity

μ_e = electrophoresis mobility

E = applied electric field in capillary (volt/cm)

Mobility is a ratio of electrical force mobilizing which the charge that mobilizing the species against frictional force that resisting the mobility. Frictional force defines by mass and viscosity of the medium see equation (2.2) (Agilent Technologies, 2000). In the separation process, substances that have the same mobility can appear to be inseparable, but with adjustment of the running buffer they can obtain different effective mobility which in turn makes the species with same mobility separable. Separating substances with same μ_e in CE it's highly depended on the buffers pH and composition. The ion charge can be controlled by adjusting the running buffer for weak acids and bases (Heiger, 2000).

$$\mu_e = \frac{q}{6 \pi r \eta} \quad (2.2)$$

Where

q = ion charge

$6 \pi r$ = ionic volume

η = solution viscosity

Equation (2.2) shows that small and highly charge species have higher mobility than a large molecule with low charge.

CE principles are based on is Electro-osmotic flow (EOF). Inside the capillary there's an effect of EOF when a capillary inner wall is exposed to a buffer, higher than pH 2. The following reaction (2.3) occurs when the capillary is filled with electrolyte.



The negatively charge capillary walls (Si-O^-) is reacting with buffers cations and form a layer inside the capillary wall. Another layer of cations that loosely attached to the wall will move

forward the detector end when high voltage potential applies all through the capillary. Movement of the positively charge ions drags the solution somatically through the capillary creating an EOF fig. 2.2 (Tagliaro, Manetto, Crivellente, & Smith, 1998).



Fig. 2.2, of a EOF flow inside the capillary where the wall is negatively (-) charged, fixed layer is cover by the positive (+) ions and the diffuse layer containing a mixture of (+) (-) and neutral (n), move forward the negative end.

EOF is expressed though mobility or velocity through the equation below.

$$v_{EOF} = \left(\frac{\epsilon \zeta}{\eta} \right) E \quad (2.4)$$

$$u_{EOF} = \left(\frac{\epsilon \zeta}{\eta} \right) \quad (2.5)$$

- v_{EOF} = velocity
- u_{EOF} = EOF mobility
- ζ = zeta potential
- ϵ =dielectric constant

The charge distribute through the double layer causing potential drop called Zeta potential. The zeta potential is dependent of the buffer ionic strength and the charge on the capillary inner wall. The EOF is increasing along with zeta potential when pH is increasing. Fig. 2.3 shows the relation between pH and EOF mobility, at low pH the silanol group remain unchanged, at higher pH the silanol group is deprotonated and therefore charged (Agilent Technologies, 2000).

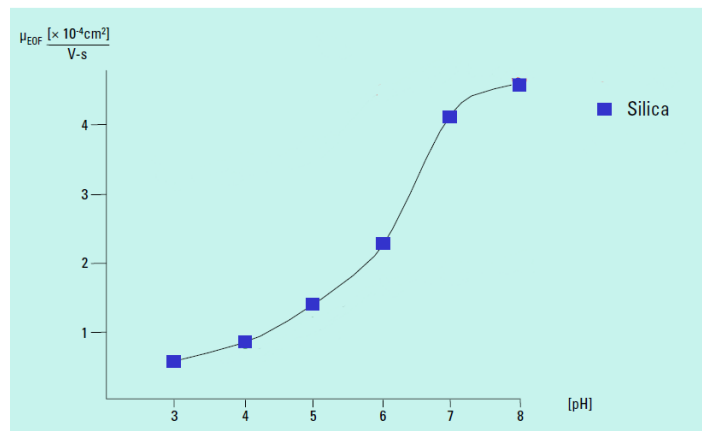

Fig. 2.3, The EOF mobility curve follows the trend of silanol titration curve. Increasing pH will also increase the EOF mobility(Agilent Technologies, 2000).

2.2 Separation modes in CE

There are different separation modes in CE, capillary zone electrophoresis (CZE), Micellar electrokinetic chromatography (MEKC), capillary gel electrophoresis (CGE), capillary isoelectric focusing (CIEF), and capillary isotachopheresis (CITP). The separation mode can be altered using different buffer or changing the capillary (Weston & Brown, 1997).

2.2.1 Capillary zone electrophoresis

CZE is a basic of CE where analytes are separated in different zones through the effect of EOF depending on various ions mobility. In fig. 4 shows that small and highly positively charge ions will move faster forward the capillary end following by, large positive molecule, neutrals, and large negative ions and at last small highly negative ions. Neutrals in the sample is detectable but inseparable from the EOF flow in CZE hence they are not charge. (Agilent Technologies, 2000)

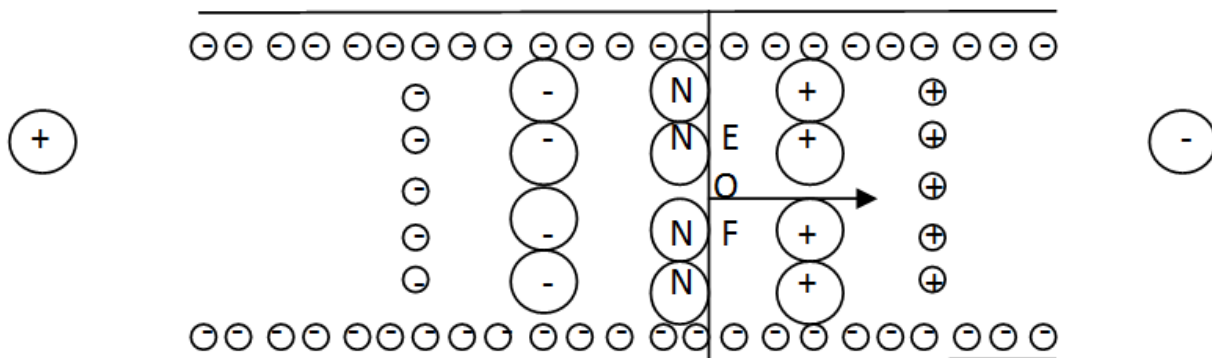

Fig. 2.4, Show ions with different charge and mass separate zone wise in CZE mode, negatively charge ions (-), neutral ions (N) and positively charge ions (+).

Separations in CE occur in the capillary when it's fills with buffer solution and under the influence of an electric field. The choice of buffer solution is important for any CE separation, it have to maintain constant pH, good buffering capacity, low absorbance at the selecting wavelength of detection and low mobility (Heiger, 2000). The buffer role is to control the pH (affecting mobility and EOF) of the carrier electrolyte and maintaining the electrical continuity. Low concentration buffer provide faster separation while compromising the sample loading capacity and high concentration buffer can be too conductive for high performance capillary electrophoresis (HPCE) system. According to Weinberger buffer selection can be generalize by using the borate buffer (pH 9,3) for analyses of acid and phosphate buffer (pH 2,5) for bases, in combination with an appropriate additives will work for most applications. Except for bases that are not soluble in phosphate buffer, acetate buffer (pH4) can be more effective.

The buffer additive functions are modifying mobility and EOF, preventing sample from absorbing in to the capillary wall, and maintaining solubility (Weinberger , 2000). A list of data on commonly use buffers can be found in appendix 1. Buffer additives and its range of use can be found in and appendix 2.

Application for CZE is a wide range of ions diversity, peptide mapping, determination of drugs and drugs metabolites, environmental analysis, inorganic ions, amino acid, protein analysis etc. are separated using CZE mode (Heiger, 2000).

2.2.2 Micellar electrokinetic chromatography

MEKC is a crossover of chromatography and electrophoresis that's widely to separate small neutral compounds (Heiger, 2000). It's also a powerful technique to separate mixture of both charge and neutral species and become a highly competitive alternative method to liquid chromatography (Silva, 2007). The electrophoresis mobility is based on charge to mass ratio. Neutral compounds lack the self-electrophoretic mobility that's require for separation in electrophoresis therefore a neutrals species will mobile forward the detector in one unresolved peak (Deeb, Iriban, & Gust, 2011). In order to separate the uncharged compound a surfactant modifier is added in to the running buffer and forms a micelle (spherical of surfactants hydrophobic tail) which acts as a pseudo-stationary phase micelle when the critical micelle concentration (CMC) of the surfactant in buffer is reach. Separation in MEKC based on deferential partitioning of analyte in micellar and solution phase. Micellar that formed are usually charge and dependent on its charge mobile forward anode (against EOF under normal condition) or catode. A common surfactant in MEKC is an anion, sodium dodecylsulfate (SDS) which travels against EOF. Charge analyte that mobile through the capillary is interacting with the micellar through hydrophobic and/or electrostatic interactions while neutral analyte only partitioning in and out if the micellar (size dependen). Long interaction with micellar result in lower mobility for analyte therefore migrates slower to the detector end fig. 2.5 (Heiger, 2000). A table content of commonly use surfactant modifier and its CMC are listed in appendix 3.

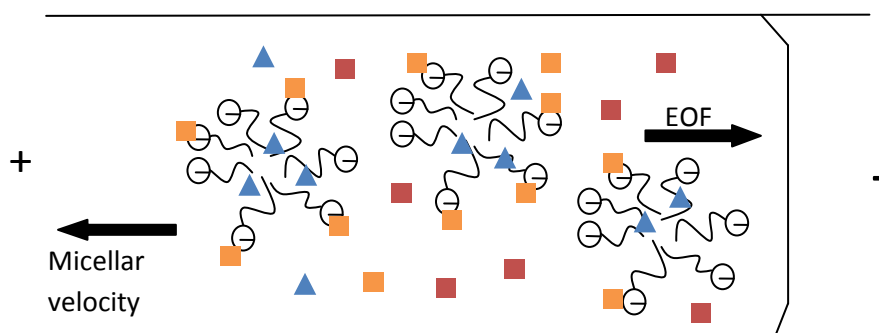

Fig. 2.5, Schematic of MEKC separation process where, ■ ■ ▲ is analytes.

The resolution can improve by modification in surfactant (effecting micellar size, charge and geometry), buffer concentration (affect hydrophobic interaction between solute-micellar), pH (affect EOF), temperature (affect velocity) and additives (affect the solute-micelle interaction) (Heiger, 2000). MEKC applies in numerous of analytical fields e.g. pharmaceutical, bioanalysis, cancer research, chiral separation, food and environmental analysis and plant analyses (Deeb, Iriban, & Gust, 2011).

2.2.3 Capillary gel electrophoresis

CGE origin from slab or tube electrophoresis it's mainly use for separation of macromolecules such as proteins, nucleic acid by the size of the molecules since the mass-to-charge ratio barely change with size. Separation occur when solution migrate through the capillary fill with gel (polymer) filled column. The analyte are hindered by a network of polymer in the capillary there they separated depending on size differentiation of the molecular. Smaller molecule mobiles through the pores easier and faster and therefore pass the detector before larger molecules. Separations of the molecules are arranged zone wise much like CZE. CGE can apply 10 to 100 times higher electric field and maintain a good resistance against joule heating effect compares to the traditional slab gel electrophoresis. Suitable material in the capillary has a high resistance against joule heating effect while maintaining the shape and pore size. Gel use in CGE is crosslinked polyacrylamide (DNA, SDS binds protein), linear polyacrylamide (restriction fragment), agarose (restriction fragments, protein) (Heiger, 2000). To prevent the EOF from pushing gel out of capillary coated capillaries is recommended. Concentration and chain length of polymer affect the pore size. The best way to modify the mesh size is to alter the polymer chain length to gain a wide range in biopolymer separation (Weston & Brown, 1997).

2.2.4 Capillary isoelectric focusing

CIEF is a well-established gel electrophoresis technique use to separate zwitterion species such as peptides and protein. CIEF separation are based the isoelectric point (pI) of analyte. The carrier in this separation is an ampholytes solution contain zwitterionic with the desirable pH range. The cathode end is surrounded in a high pH buffer (e.g. 20 mM NaOH) reservoir and anode end surrounded in low pH buffer (e.g.. 10-20 mM H₃PO₄) solution. pH gradient formed inside the capillary when its filled with sample and ampholytes, the compound become charged and separation occur dependent on analytes pI value. Once the voltage is apply the compounds will become charged and migrating to the zone where they become neutral (uncharged). The separation is completed once the steady-state is reached and current is no longer in effect. All the compounds (sample and ampholytes) zones migrate forward the detector through

application of pressure to the capillary or by adding salt in the one of the reservoir. Coated capillary is recommended in order to reduce or remove the EOF since it affects the mobility of the analyte. It could transport the compounds pass the detector before the separation is stabilized. Coated capillary also minimize of the solute absorption (Heiger, 2000) (Weston & Brown, 1997).

2.2.5. Capillary isotachopheresis

CITP mode is use to separate anionic or cationic compounds analyze of a mixture of both types of ions simultaneously is not possible in this mode. The separation process for CITP is separated using a combination of two buffer system creating an environment where all ions divided in zone mobilize in same velocity. The zones remains divided and leads by the zone of ions with the highest mobility and end with species containing the lowest mobility in the solution. The separations occur under the effect of electric field which divided the compounds into zones depending on their mobility. The electric field is adjusted to maintain a constant velocity. Once the separation is done each zone will contain only once specific compound. The leading buffer must contain a mobility that's higher than all analyte and a terminating buffer consist of ions with lowest mobility, buffer with high mobility will lead the separated zones forward the detector and end with the lower buffer in between is the analytes. All compounds move forward the detector under the same velocity which is the velocity of the leading buffer (Heiger, 2000) (Weston & Brown, 1997).

2.3. Surfactants

Surfactants characteristic are divided into various types depending on the nature of their hydrophilic (lyophobic) head groups. The main groups are the anionic, cationic, non-ionic, amphoteric fig. 2.6 (Hargreaves, 2003). Surfactant (amphipathic) is an amphiphilic compound containing a hydrophilic group (polar, head group) and hydrophobic group (non-polar, tail group, lipophile). The amphiphilic nature of surfactants acts as a surface- active agent who is beneficial in, suspending, floating, emulsifying, demulsifying, wetting, detergency, and foaming (Schramm, 2008). When surfactants dissolve in solvent environment for example water, it changes the water structure, triggering the hydrogen bounds between water molecules to breaks. The non-polar part of surfactant strives forward the surface to avoid contact with water while the polar part preventing surfactant from expelled from liquid phase. The water surface becomes covered with surfactant with lipophilic groups struggles to interact with air, lowering the tension on the water surface (Rosen & Kunjappu, 2012).

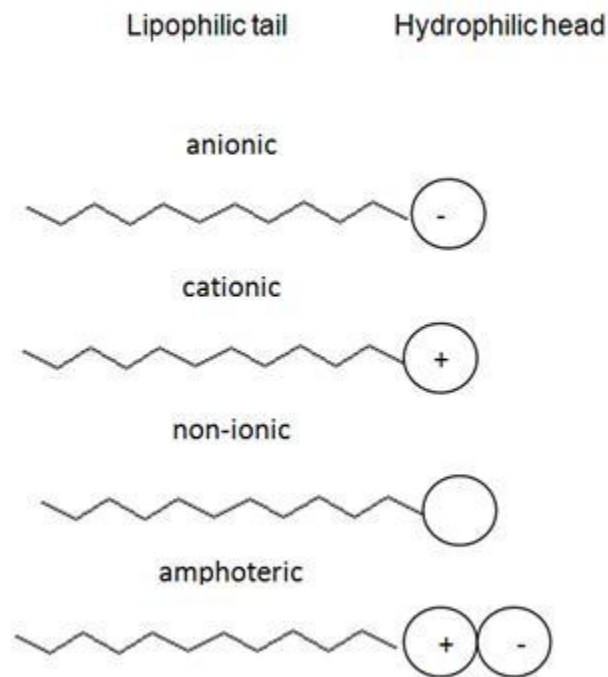

Fig. 2.6, Simplified figure of surfactant main types showing placement and charge of lipophilic tail and hydrophilic head.

Surfactant is also able to form micelle in solvent when the critical micelle concentration (CMC) is reached. CMC is reached when the solution contains excessive amount of surfactant and the

surface is no longer able to accommodate room for all the surfactant in the solution the overloaded surfactant start to agglomerate to form micellar. Three types of micelle structure can be formed depends on surfactant and solvent ratio, spherical, cylindrical rods, and layers. At CMC the lipophilic tails start to interact to other lipophilic tails in the solution and form sphere bound by the Wan der Waals forces. The charge of the hydrophilic head causes the surfactant molecules to curve which result in sphere with a lipophilic in the core and hydrophilic head on the outer edge of the sphere fig.2.7 b. When the concentration of surfactant is increasing the micellar start a spear-to-rods transition and formed a cylindrical rods (fig. 2.7 c) and eventually formed a hexagonal arrangement shown in fig. 2.7 d. In pure surfactant (zero water) molecules in surfactant are arranged in layers fig. 2.7 e (Hargreaves, 2003). The area of application of surfactant depends on the charge on the hydrophilic head (Kosswig, 2000).

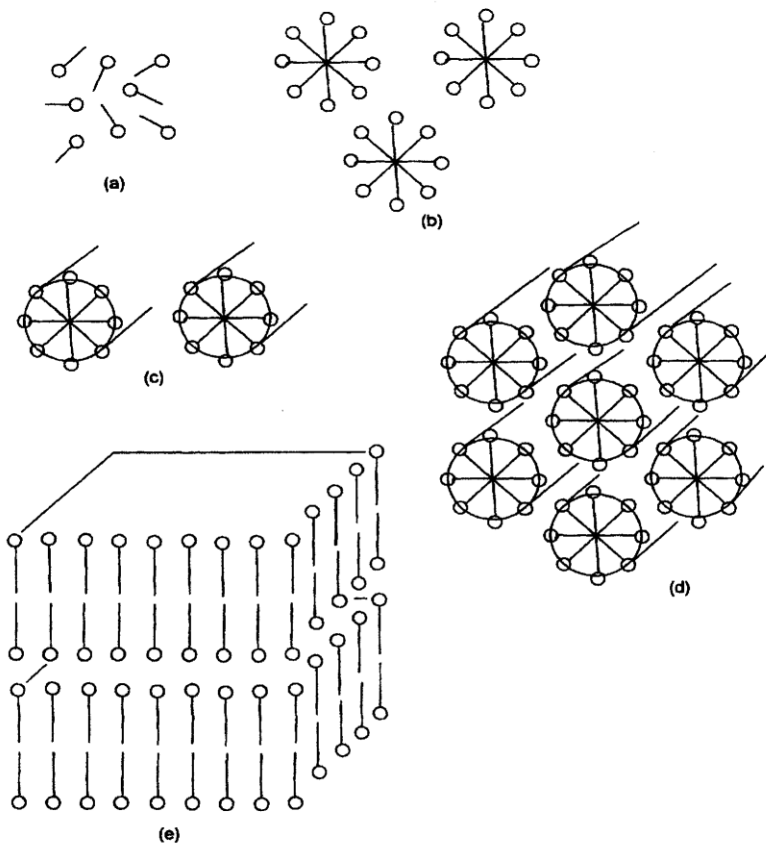

Fig. 2.7, a) Surfactant in solvent. b) Surfactant in solution forming micelles sphere once the CMC is reached. c) Concentration of the surfactant is passing CMC and started the sphere rearranged in to cylindrical rods. d) Increasing more surfactant eventually leads to hexagonal arrangement of cylindrical rods. e) In a zero water environment, surfactants are arranges in layers. (Hargreaves, 2003)

2.3.1. Anionic surfactant

Anionic surfactants consist of negatively charge lipophilic head group and a counter ion such as sodium, potassium or ammonium (Kosswig, 2000). There are many types of anionic surfactant for example alkylaryl sulfonates, alcohol sulfonate, ether sulfates, phosphate ether, sulfosuccinates and sarcosinates. Anion surfactant foaming, sensitivity to water, protein denaturation and dispersing ability make it suitable as detergency, emulsifier, fire fighting foam, pharmaceuticals, and polymerization and De-inking (Hargreaves, 2003) (Fainerman, Möbius, & Miller, 2001).

2.3.2. Cationic surfactants

Cationic surfactants consist of positively charge head group and counter ion such as chloride, sulfate or acetate (Kosswig, 2000). The chemical structures are divided into main classes such as, alkyl amine, ethoxylated amines, imidazolines, and quaternaries (90% of cationic production). The typical application for cationic surfactants are bactericides, fungicides, herbicides, hair conditioner, fabric softener, antistatics, corrosion inhibitor and flotation agent (Fainerman, Möbius, & Miller, 2001).

2.3.3. Nonionic surfactants

Nonionic surfactants are amphiphilic compounds with no charge and does not disassociate into ions under its working range of pH. Nonionic surfactants can become charge depending on pH value for example polyethers and polyethylene oxide becomes positively charge under the acidic conditions (Fainerman, Möbius, & Miller, 2001). It's an excellent emulsifier and compatible with all other types of surfactants. Most of the non ionic have an ethylene oxide (EO) chain in the hydrophilic part which affect the solubility in water (more EO more soluble in water). The number of EO group can be adjusted to fit solubility in water or oil, low EO group good solubility in oil and poor solubility in water. Basic structures of nonionic surfactants are fatty alcohol ethoxylates and alkyl phenol ethoxylate (Hargreaves, 2003).

2.3.4. Amphoteric surfactants

Amphoteric surfactants is pH dependent containing both positive- and negative- charge within the same molecule which offer a good detergency, high foaming capacity and gentle to the skin. It becomes a cationic molecule in an acidic environment and anionic molecule in alkaline solution it can also act as a secondary surfactant (main one being anionic or cationic surfactant). This type of surfactant is mainly use in mind shampoo and shower gel (Hargreaves,

2003). The common amphoteric surfactant can be dividing in two classes, N-Alkyl amino acids, and N-acyl amino acid (Fainerman, Möbius, & Miller, 2001).

2.4. Surfactants products analyze with CE system?

The experiment will be performed on two different surfactant Ampholak YJH 40 an amphoteric surfactant and Phospholan PE 65 (phosphate ester) produces in Stenungsund site. During the production of Ampholak YJH 40 acrylic acid (AA) and 2-Eha was added into the mixture. The quality control of the product is require AA < 2,0% and 2-EHA < 0,20%. Phospholan PE 65 is produces by phosphorated fatty alcohol ethoxylates. The finished product requires phosphoric acid (PA) to be less than 2% (PQC Akzo Nobel, 2010) (PQC Akzo Nobel, 2009). In ion form PA and AA is negatively charge (fig. 2.9 and 2.10) while 2-EHA is positively charge fig. 2.8.

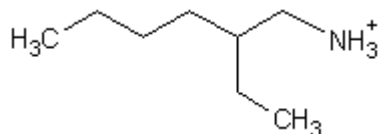

Fig. 2.8, 2-ethylhexylamine ion

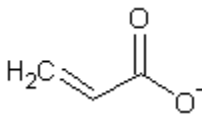

Fig. 2.9, Acrylic acid ion

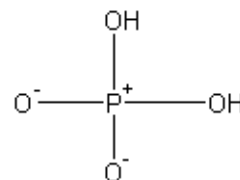
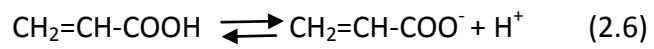

Fig. 2.10, Phosphoric acid ion

The CZE mode is selected for the experiment since it's suitable for analyses of cations and anions in a mixture. It is desirable to determine both AA and 2-EHA in Ampholak YJH 40 in one run since the analytes are negative- and positive small ions which fits the criteria for CZE mode. All three compounds are soluble in water and separable from the surfactants product by the differentiation in charge and size and pKa value (Heiger, 2000). All three analytes can be determined with indirect UV detection. The sensitivity is compromise but compound with weak UV absorption is detectable. 2-EHA requires a pretreatment process to amplify UV absorbance with Indirect UV detection pretreatment process can be avoided since the separation is based on mobility matching between analyses and the carrier electrolyte coion (chromophores) in BGE (Klampfl, Katzmay, & Buchberger, 1998) (Koike, Kitagawa, & Otsuka, 2007).

AA acid is known to spontaneously dimerizes via ionic mechanism shown below (reaction 2,6 and 2,7). This could be problematic for determination of AA since the dimerization changes charge and size of the components therefore AA will be separated and appear in separated peaks. The method to prevent the dimerization is currently unknown. (BASF Corporation, Celanese, Ltd., Elf Atochem North America, Inc., Rohm & Haas Company, Union Carbide Corporation).

Acrylic acid ionization



Michael type addition

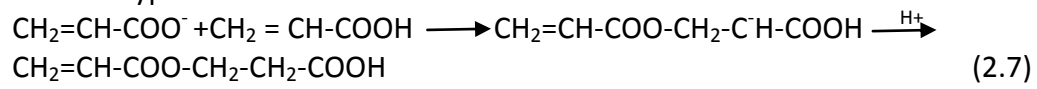

3. Experiment

Akzo Nobel research laboratory in Stenungsund has not yet establish CE instrument, therefore all CE experimenting were done in Akzo Nobel laboratory in Deventer in Nederland. The capillary, buffer solutions, CE instrument, acrylic acid, phosphoric acid, and 2- ethylhexylamine was provided by the laboratory in Deventer, all the chemical were of analytical grade. The experiment was conducted under guidance of Carina Evertse, CE research chemist. All the sample and standard solution were diluted in deionized water. Test sample of Phospholan PE 65 and Ampholak YJH 40 was provided from Akzo Nobel.

3.1. Equipment and settings

All the experiments were performed using a G1600 HP^{3D} CE system equipped with UV-VIS DAD, fig 3.1. The choice of detection was indirect UV, signal range of 210 to 250 nm. The experiments were conducted with hydrodynamic injection at 50 mbar, 5 sec injection time or electrokinetic injection at 25 kv, 10 sec injection time. Fused silica capillary of 50 cm long, 41,5 cm effective length with an inner diameter of 50 μm and cassette temperature at 30°C were used. Software used to run CE system was 3D-CE chemstation (Rev. B. 04.03(54)), Chromeleon was used to edit all electropherogram in the experiment.

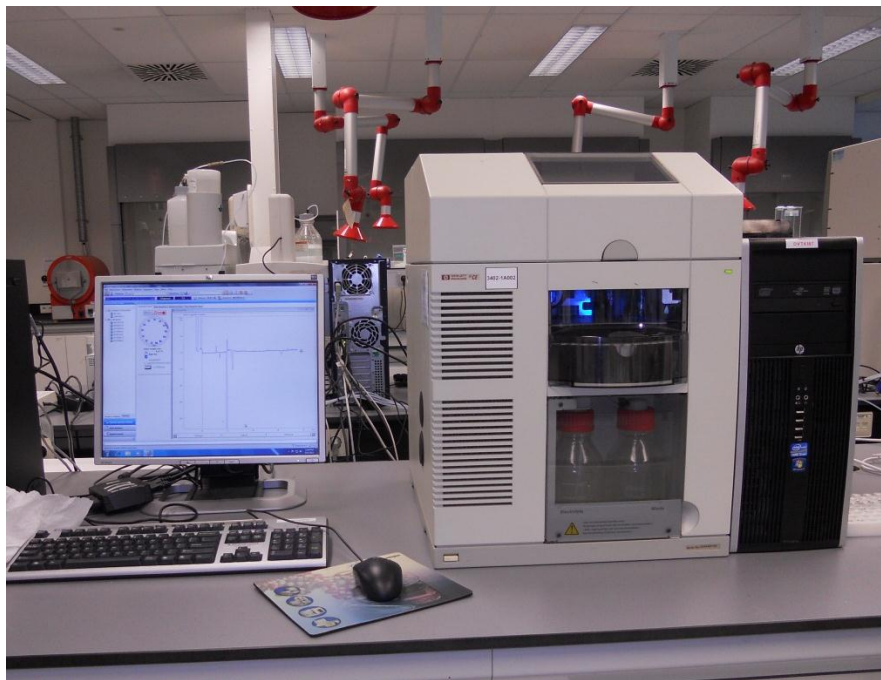

Fig 3.1, HP^{3D} CE system equipped with UV-VIS DAD detector used in the experiment. Connected to the CE is a computer installed with 3D-CE chemstation software, managing CE settings and collecting data from all run.

Installing new capillary requires that the edge of the capillary bevelled and the protective polyimide is removed at the detector window, where detection occurred in CE see fig. 3.2. The coating is removed using a special tools designed to burn off the polyimide coating. After the capillary preparation was done it was inserted into a cell holder where the area, free from coating is placed on the right position through the cell holder (fig. 3.3). A picture where cell holder position is located in the cassette can be found in fig. 3.4.

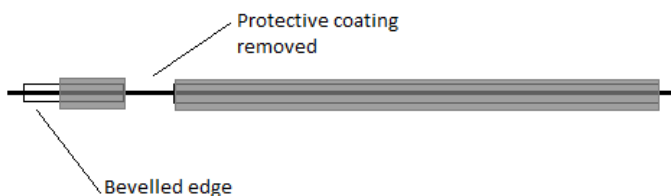

Fig. 3.2, Capillary with the polyimide coating removed ready to insert into a cell holder.

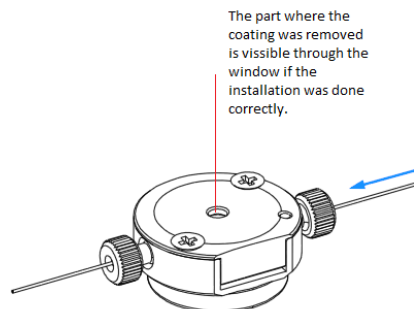

Fig 3.3, A Cell holder with a capillary inserted through it. The insertion stop where the coating free part is visible through the window marked in the picture. Both fittings on the side tighten once the capillary reached the precise position. (Agilent Capillary Electrophoresis System User's Guide, 2000)

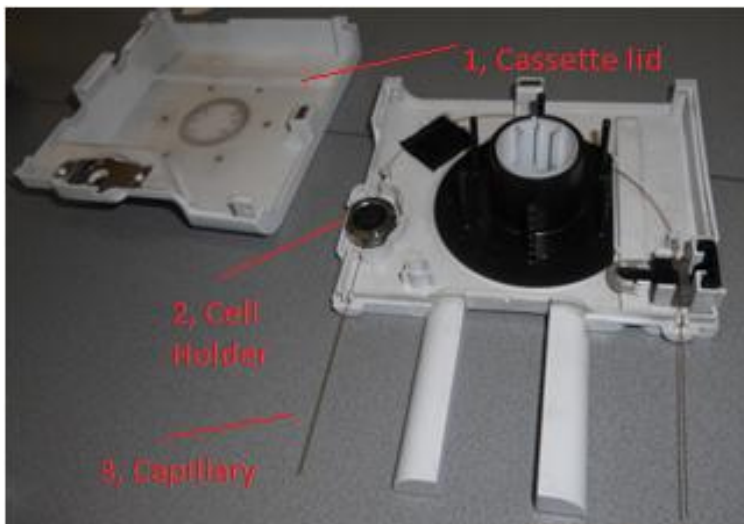

Fig. 3.4, Inside a capillary cassette with fused silica capillary of 50 cm total length (41,5 cm effective length), and 50 μm capillary installed.

The 1L buffer provided by Deventer laboratory consist of 1,66g phthalic acid, 40 mg EDTA- $\text{Na}_2\text{H}_2 \cdot 2\text{H}_2\text{O}$ and diethanolamine. A mixture of phatalic acid and EDTA- $\text{Na}_2\text{H}_2 \cdot 2\text{H}_2\text{O}$ were diluted in 900 ml deionized water and adjusted to pH 9,1 by adding 10% diethanolamine in the solution. Once the buffer reached 9.1 pH more deionized water was added till total solution of 1L.

The installed capillary was flushed with water, 1M sodium hydroxide (NaOH), and buffer solution before used. The initial conditioning was a part of the capillary preparation process the sequence shown on the table below ends with buffer to equilibrate the capillary. The capillary was ready to use after precondition process shown in the table below.

Table 3.1, Precondition sequence for the capillary before use. Run time for each flush was 10 min.

Flush	Solution
1	Water
2	NaOH
3	Water
4	Buffer

The carrier electrolyte was prepared in to 2 ml glass vials (Agilent Part nr. 5182-9697) with snap on lid (Agilent part nr. 5181-1512) and placed on a sample tray with an auto injection system. The vial is placed on the positions 3 to 8 to fit the running sequence setting. Buffers in position 5 to 8 and needs replenishing after the maximal of six runs due to the changes in buffer composition after multiply runs. Position 3 and 4 were inlet- and outlet home vial, used for the separation. In the experiment water sample were placed in position 13. All run sequence begun and end with flushing of water to clear the capillary from analytes.

3.2. Standard solutions

In order to verify that the acrylic acid and 2-ethylhexylamine was detectable with CE method various standards samples were prepared and analyzed. A stock solution of 10 mg/ml AA, 2-EHA and PA was made and diluted to various concentrations of standards se table 3.2. The stock solution for AA was prepares by 1 g of AA diluted with deionized water to 100 ml mark in a 100 ml volumetric flask. Preparation of 2-EHA stock solution uses the same procedure. PA stock solution was phosphate solution of 1 mg/ml manufacture by Alltech. The standard schematic listed in table3.3.

Table 3.2, Shows the concentration of the acrylic acid, 2- ethylhexylamine and standards used to construct calibration curve derived from 10 mg/ml stock solution. No standard at 1 mg/ml for AA was prepared.

AA and 2-EHA Standard nr.	Stock solution used (ml)	Diluted to (ml)	Concentration (mg/ml)
1 (no AA)	10 (no AA)	100 (no AA)	1 (no AA)
2	5	100	0,5
3	1	100	0,1
4	0,5	100	0,05
5	0,1	100	0,01

Table3.3, Stock solution of phosphate was 1 mg/ml. No dilution were made for the first standard, the rest is diluted according to the table.

Phosphate standard nr.	Stock solution used (ml)	Diluted to (ml)	Concentration (mg/ml)
1	-	No dilute	1
2	5	10	0,5
3	1	10	0,1
4	0,5	10	0,05
5	0,1	10	0,01

A lower concentration of 2-EHA stock solution (1,2 mg/ml) were prepared for construction of another calibration curve. The dilution conditions are showed in table 3.4. After the preparations of standard solutions were done, all samples were prepared in 1 ml polypropylene flask (Agilent part nr. 5182-0567) with snap on lid (Agilent part nr. 5181-1507) and placed on the sample tray.

Table 3.4, Describes the condition of standard solutions using a 1,2mg/ml 2-EHA stock solution.

2-EHA standard nr.	Stock solution used (ml)	Diluted to (ml)	Concentration (mg/ml)
1	10	100	0,12
2	5	100	0,06
3	2	100	0,024

3.3. Test sample

The test sample for the experiment was two types of surfactant products, Phospholan PE 65 and Ampholak YJH 40. There were three test samples of both products. A complete list of samples properties are listed in the table 3.5. Phospholan PE 65 contains PA and Ampholak YJH 40 contains AA and 2-EHA. One sample from each batch was prepared by weighing approximately 100 mg in a 100 ml volumetric flask diluted with ionized water to 100 ml mark (on the flask). A complete data of all six samples are listed in the table 3.6.

Table 3.5, Properties of Phospholan PE 65 and Ampholak YJH 40. Data provided from Akzo Nobel product database.

Product name	Batch nr.	PA result from UV-spectrometer (%)	AA result from HPLC method (%)	2-EHA result from HPLC method (%)
Phospholan PE 65 (1)	04-119651	1,3	-	-
Phospholan PE 65 (2)	04-120765	1,4	-	-
Phospholan PE 65 (3)	04-122045	1,3	-	-
Ampholak YJH 40 (1)	89-29610	-	0,91	0,02
Ampholak YJH 40 (2)	89-30279	-	1,15	0,02
Ampholak YJH 40 (3)	89-30422	-	1,32	0,01

Table 3.6, Shows the AA, PA and 2-EHA concentrations in the sample after the preparation.

Product name	Batch	Weight (mg)	Diluted to (ml)	Sample Concentration (mg/ml)	PA Concentration in the sample (mg/ml)	AA Concentration in the sample (mg/ml)	2-EHA Concentration in the sample (mg/ml)
Phospholan PE 65 (1)	04-119651	102,1	100	1,02	0,013	-	-
Phospholan PE 65 (2)	04-120765	118,9	100	1,19	0,017	-	-
Phospholan PE 65 (3)	04-122045	114,2	100	1,14	0,015	-	-
Ampholak YJH 40 (1)	89-29610	104,1	100	1,04	-	0,0095	0,0002
Ampholak YJH 40 (2)	89-30279	119,1	100	1,19	-	0,0137	0,0002
Ampholak YJH 40 (3)	89-30422	105,6	100	1,06	-	0,0139	0,0001

Three test sample containing 2-EHA and AA mixture was prepared from stock solution of 1,17 mg/ml 2-EHA and 1,7 mg/ml AA. 117 mg of 2-EHA was diluted with deionized water in a 100 ml volumetric flask. Same procedure was done with 170 mg AA. The stock solution was done separately due to a reaction that occurs between 2-EHA and AA when highly concentrated solutions of both substances mixed together. Test samples preparations were done according to table 3.7.

Table 3.7, Sample taking from each stock solution was mixed in a 100 ml volumetric flask and diluted with deionized water till 100 ml mark on the flask.

Sample nr.	AA stock solution 1,7 mg/ml (ml)	2-EHA stock solution 1,17 mg/ml (ml)	Diluted to (ml)	Concentration AA (mg/ml)	Concentration 2-EHA (mg/ml)
1	10	10	100	0,173	0,117
2	0,5	0,5	100	0,086	0,058
3	0,1	0,2	100	0,017	0,023

4. Result and discussion

4.1. Phosphate result

At the first run using the original buffer PA was not detectable after 10 min due to the long migration time for phosphate therefore the original buffer was diluted to 50% to increase the phosphate mobility in the capillary. With the 50% diluted buffer the PAs mobility amplified and CE was able to detect PA within 6 min run time, fig 4.1. At lower concentration of 0,1 mg/ml double peaks started to take shape in the electropherogram (fig. 4.2) but still not fully separated until at 0,5 mg/ml standard. In the electropherogram show in fig 4.3, the double peak was separated at lower concentration standard solutions. Calibration curve construction used the area of both PA peaks combined in order to obtain a total concentration of PA.

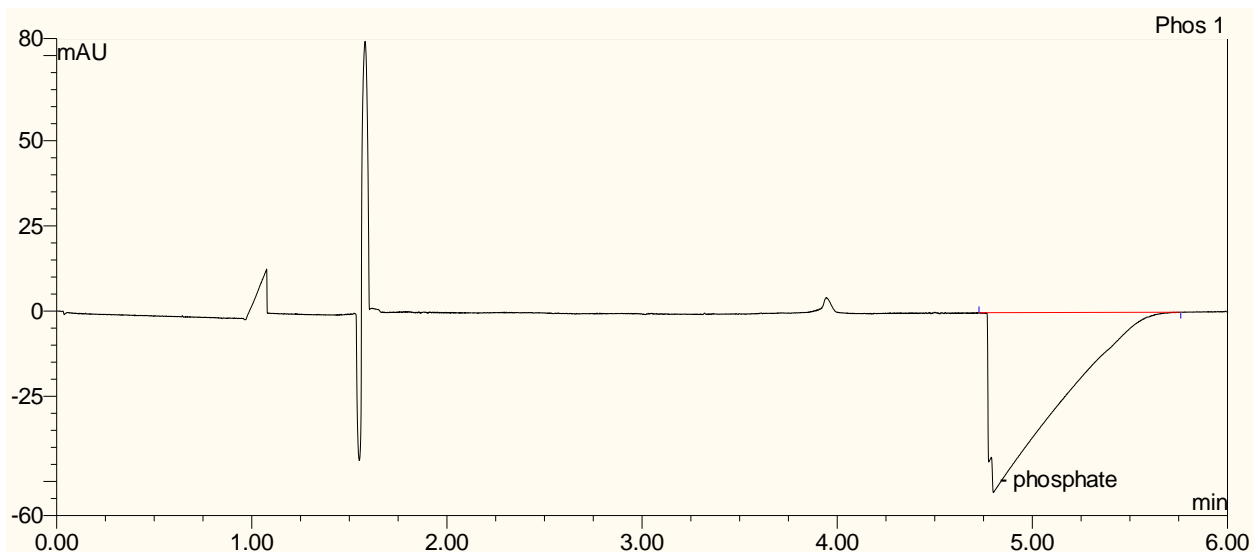

Fig. 4.1 Electropherogram of phosphate Standard solution of 1 mg/ml with 5 mM phthalic acid buffer solution and 20mg EDTA addition, pH adjustment to 9,1 with diethanolamin, fused silica capillary of 50 μm i.d. and 50 cm long (41,5 effective length) temp 30 $^{\circ}\text{C}$, Pressure injection at 50 mbar for 5 sec and detection wavelength at 229 nm, were used. At high concentration only one peak were identify in the electropherogram.

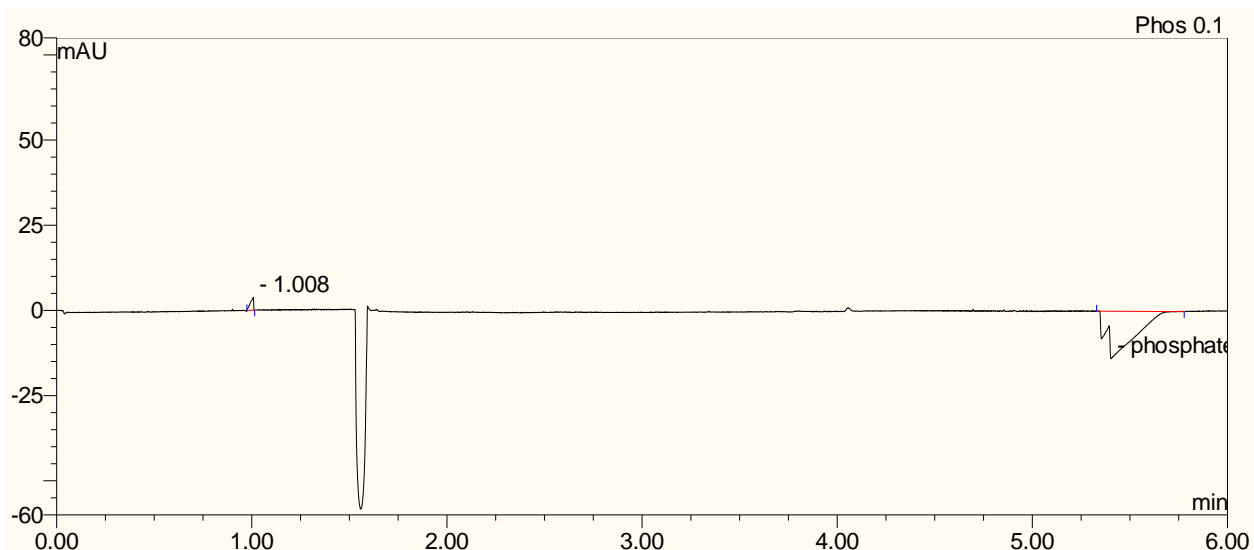

Fig 4.2 Electropherogram of phosphate Standard solution of 0,1 mg/ml with 5 mM phthalic acid buffer solution and 20mg EDTA addition, pH adjustment to 9,1 with diethanolamin, fused silica capillary of 50 μ m i.d. and 50 cm long (41,5 effective length) temp 30 $^{\circ}$ C, Pressure injection at 50 mbar for 5 sec and detection wavelength at 229 nm were used. The two peaks start to take shape but not fully separated.

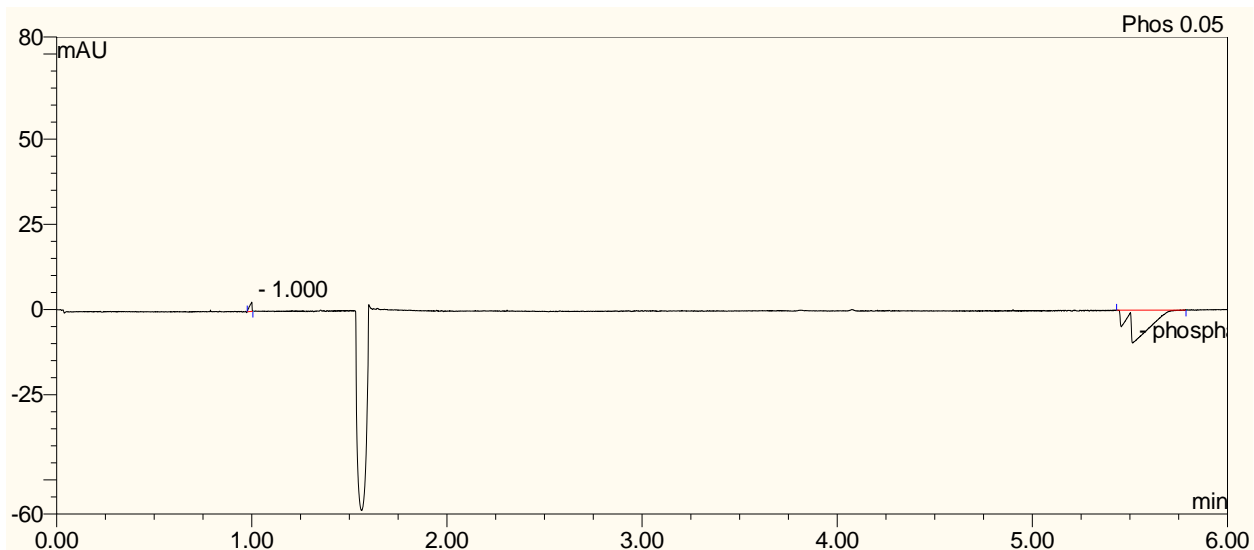

Fig 4.3, Electropherogram of phosphate Standard solution of 0,05 mg/ml with 5 mM phthalic acid buffer solution and 20mg EDTA addition, pH adjustment to 9,1 with diethanolamin, fused silica capillary of 50 μ m i.d. and 50 cm long (41,5 effective length) temp 30 $^{\circ}$ C, Pressure injection at 50 mbar for 5 sec and detection wavelength at 229 nm were used. The two peaks of phosphate separated.

Using standard solution in range of 0,01- 1 mg/ml a linear calibration curve was constructed fig 4.6. To obtain the right concentration of Phosphate both peaks must be combined when editing the electropherogram hence at 0,1- 1 mg/ml the concentration is higher and therefore no double peaks affect appear. In this case the concentration of each peak separately is not

important since both peaks are present in sample- (fig 4,5) and standard solutions. Therefore both peaks area was combined to obtain the total phosphate in the sample.

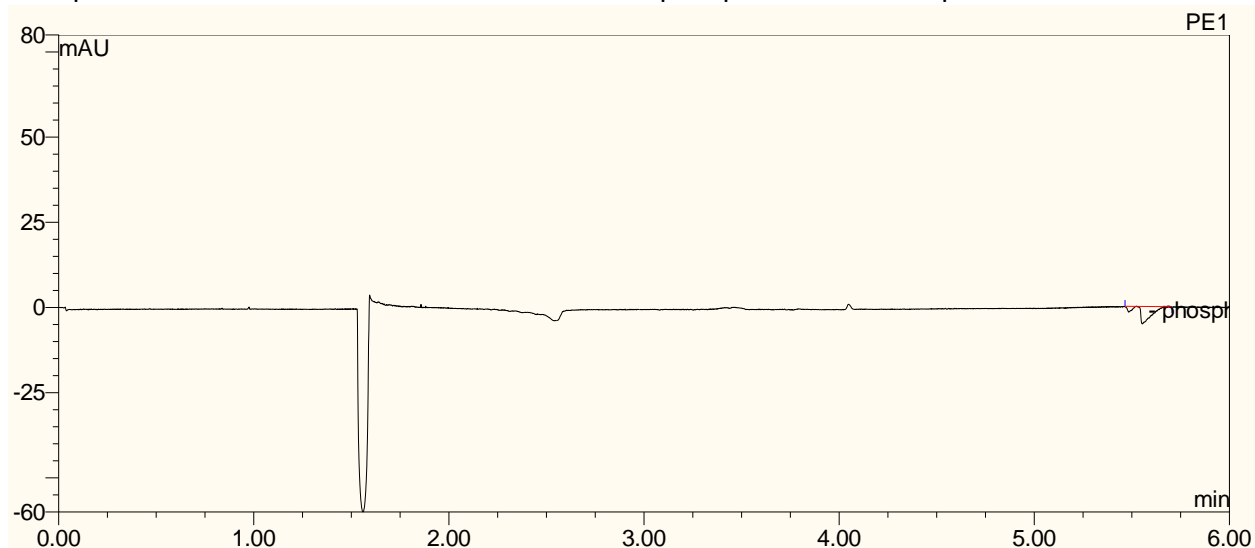

Fig. 4,5 Electropherogram of Phospholan PE 65 solution using 5 mM phthalic acid buffer solution and 20mg EDTA addition, pH adjustment to 9,1 with diethanolamin, fused silica capillary of 50 μm i.d. and 50 cm long (41,5 effective length) temp 30 $^{\circ}\text{C}$, Pressure injection at 50 mbar for 5 sec and detection wavelength at 229 nm were used. The two peaks of phosphate detected in the product sample.

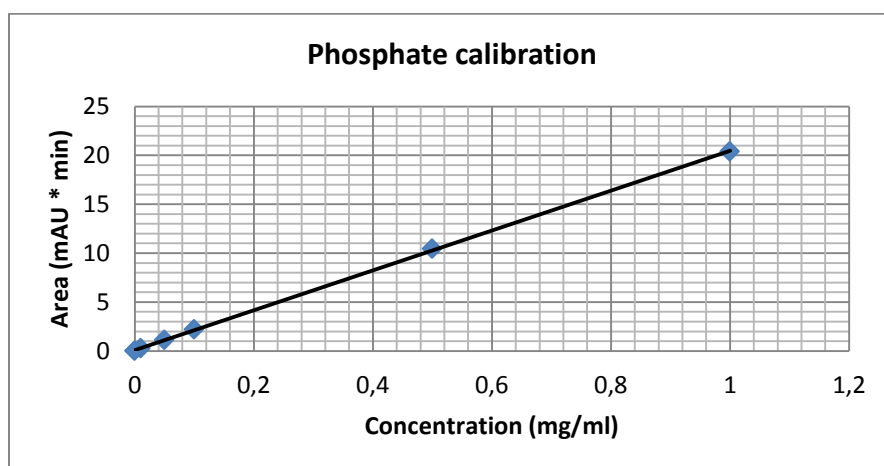

Fig. 4.6 A calibration curve for PA using a 10 mg/ml stock solution. The measuring concentration at 1, 0,5, 0,1, 0,05 and 0,01 mg/ml.

Phosphate acid concentration was able to quantify in all 3 samples of Phospholan PE 65 using the same setting as the phosphate standards. The result from CE system is being compared with an UV- spectrometer system which is an established method to detect PA in Phospholan PE 65. All the results from the UV- spectrometer method are obtained from Akzo Nobels database. The results of both methods are compared in the table 4.1 indicating that CE method detects lower concentration compare to UV-spectrometer detection.

Table 4.1, Result of Phospholan PE 65, UV spectrometer (an existing method) vs. CE system.

Sample nr.	Batch nr.	Result from UV-spectrometer (%)	Result from CE system (%)	Phosphoric acid found with CE (%)
1	04-119651	1,3	0,82	63,1
2	04-120765	1,4	0,83	59,3
3	04-122045	1,3	0,80	61,5

Result of PA in the product was obtainable in 56 min runtime which included runtime of five standards (30 min total), double analysis of the product sample (12 min total) and postrun time (equilibration time) for every run (14 min total). Sample preparation was done within 5 min and standard preparation 15 min.

4.2. Acrylic acid result

Using acrylic acid standards in range of 0,01- 0,5 mg/ml a liner calibration curve was able to construct. The result in electropherogram (fig 4.7) shows that CE was able to separate 3 different peaks of AA in the AA standard solutions. AA was able to be detected in both original buffer and the diluted buffer. However using the diluted buffer AA was able to reach the detector with less than 4 minute run time (fig. 4.8).

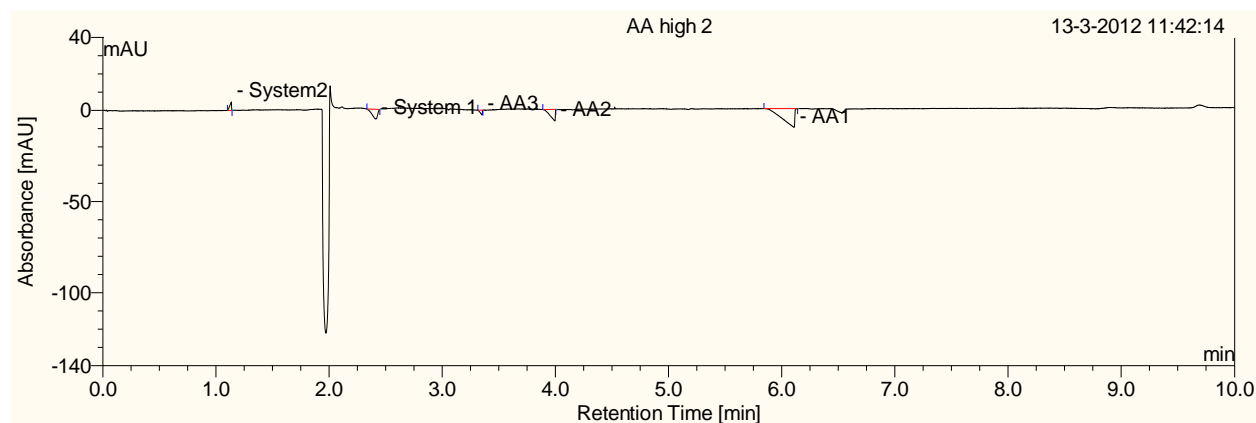

Fig. 4.7, Electropherogram of AA Standard solution of 0,1 mg/ml with 10 mM phthalic acid buffer solution and 40mg EDTA addition, pH adjustment to 9,1 with diethanolamin, fused silica capillary of 50 μm i.d. and 50 cm long (41,5 effective length) temp 30 $^{\circ}\text{C}$, Pressure injection at 50 mbar for 5 sec and detection wavelength at 229 nm were used. Using the original buffer the three peaks of AA were detected within 7 min run time.

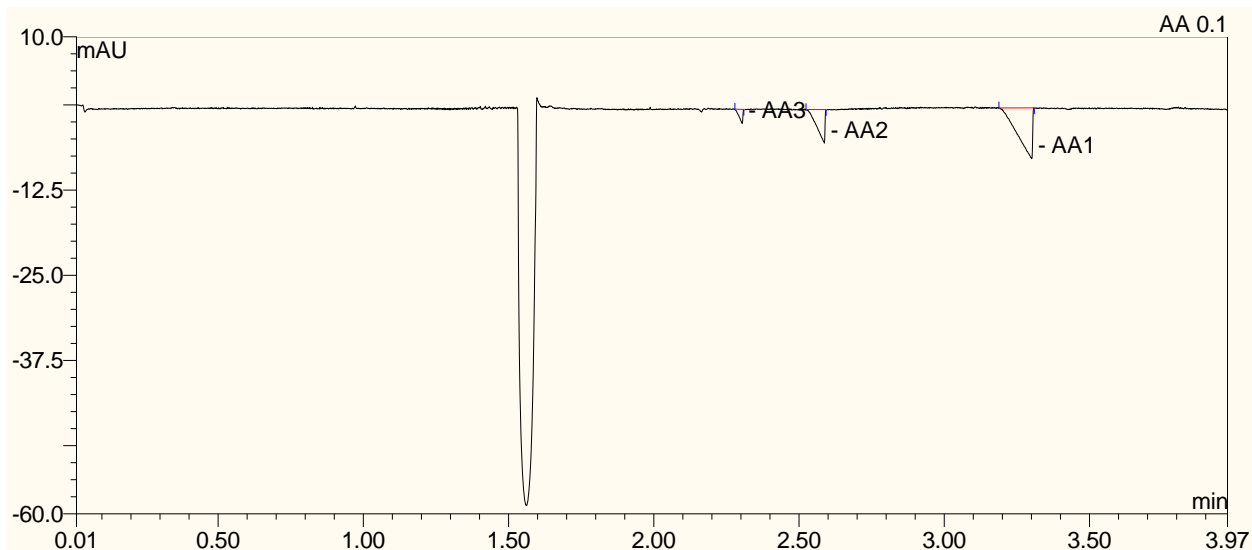

Fig 4.8, Electropherogram of AA standard solution of 0,1 mg/ml with 5 mM phthalic acid buffer solution and 20mg EDTA addition, pH adjustment to 9,1 with diethanolamin, fused silica capillary of 50 μ m i.d. and 50 cm long (41,5 effective length) temp 30 $^{\circ}$ C, Pressure injection at 50 mbar for 5 sec and detection wavelength at 229 nm were used. Using the diluted buffer Three AA peaks were detected within 4 min runtime.

When running the sample solutions of Ampholak YJH 40 only one type, AA1 was present fig. 4.9, therefore construction of the calibration curve excluded peak AA2 and AA3, hence only AA1 is needed for determination of AA concentration in the sample. Construction of a linear AA curve (fig. 4.10) contained only data of AA1 peaks using the diluted buffer.

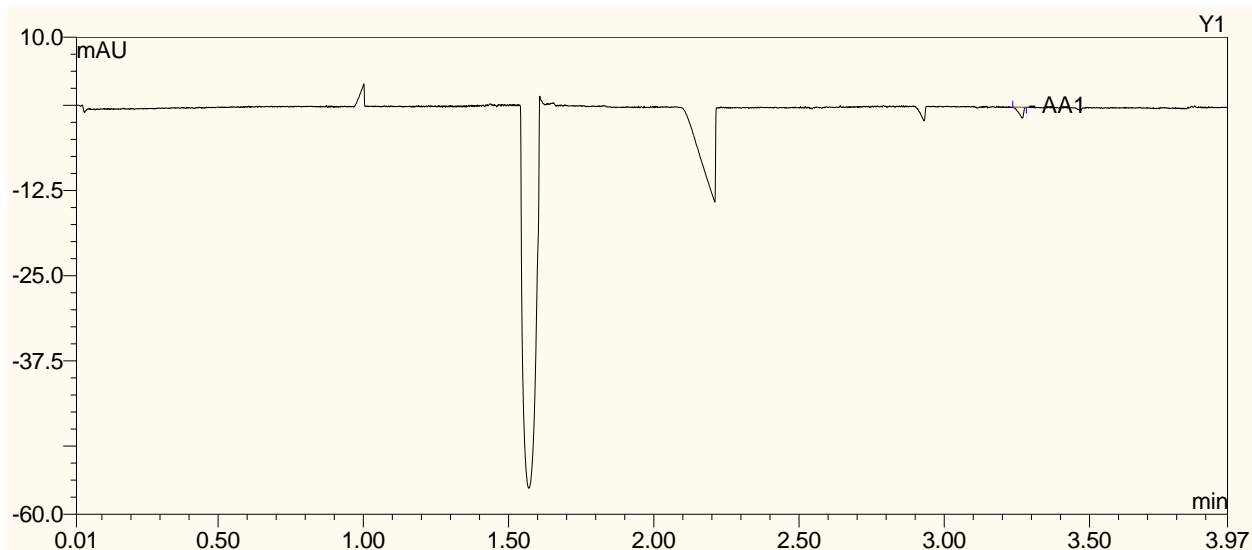

Fig. 4.9, Electropherogram of Ampholak YJH 40 solution with 5 mM phthalic acid buffer solution and 20mg EDTA addition, pH adjustment to 9,1 with diethanolamin, fused silica capillary of 50 μ m i.d. and 50 cm long (41,5 effective length) temp 30 $^{\circ}$ C, Pressure injection at 50 mbar for 5 sec and detection wavelength at 229 nm were used.

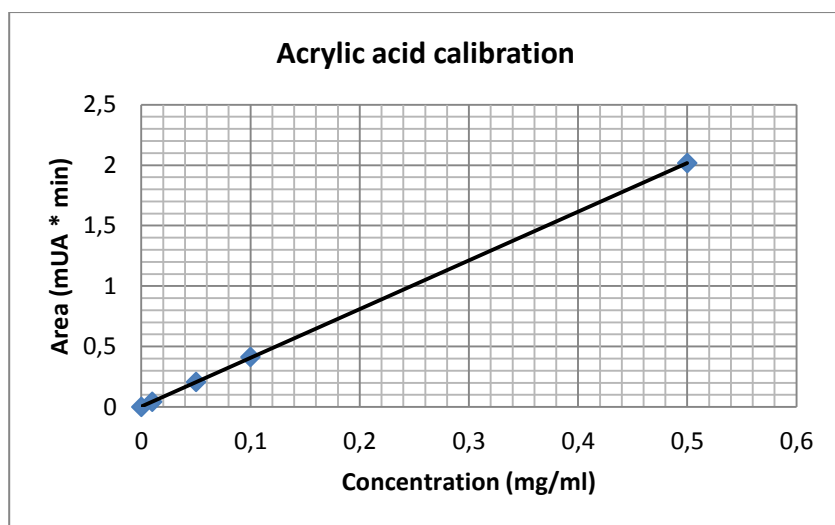

Fig. 4.10, A calibration curve for AA using a 10 mg/ml stock solution. The measuring concentration at 0,5, 0,1, 0,05 and 0,01 mg/ml using the 50% diluted buffer (bigger size curve in appendix 5).

The result from CE system is being compared with an existing method for analyses of AA in the table below.

Table 4.2, CE Result of AA in the sample compared with HPLC method.

Sample nr.	Batch nr.	Result from HPLC system (%)	Result from CE system (%)
1	89-29610	0,91	0,42
2	89-30279	1,15	0,95
3	89-30422	1,32	0,95

Result of AA in the product was obtainable in 38,5 min runtime which included runtime of five standards (17,5 min total), double analysis of the product sample (7 min total) and postrun time for every run (14 min total). Sample preparation was done within 5 min and standard preparation took 15 min.

4.3. 2- Ethylhexylamine result

Using the original buffer of 0,10 mg/ml, 10 mM phthalic acid buffer solution adding 40mg EDTA addition, pH adjustment to 9,1 with diethanolamin, 2- EHA was detectable within 2 minutes. 2- EHA is a positively charge species therefore its traveling faster forward the detector as mention earlier in CZE section. The cations in this case was 2- EHA reaches the detector (1,35 min) following by and EOF (1,85 min) as showed in the electropherogram below (fig 4.11).

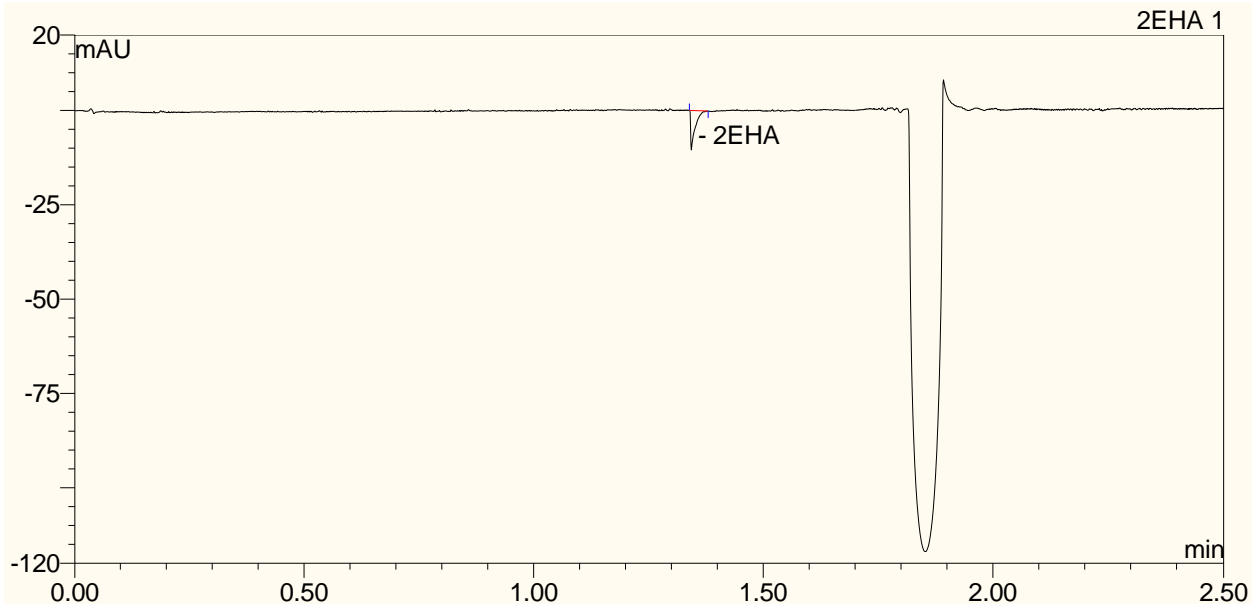

Fig. 4.11, Electropherogram of 2- EHA Standard solution of 1 mg/ml with 10 mM phthalic acid buffer solution and 40mg EDTA addition, pH adjustment to 9,1 with diethanolamin, fused silica capillary of 50 μm i.d. and 50 cm long (41,5 effective length) temp 30 °C, Pressure injection at 50 mbar for 5 sec and detection wavelength at 229 nm were used. 2-EHA was detected within 2 min runtime.

2-Ethylhexylamine (2-EHA) calibration curve show less linear calibration line when using a concentration of 10 mg/ml stock solution, lower limit detection was at 0,1mg/ml fig. 4.13. The solubility for 2 – EHA is 1,6g/l (1,6mg/ml) according to the safety data sheets which verify that the stock sample with 10 mg/ml was not fully diluted. Another observation was the high concentrated (1 and 0,5 mg/ml) stock solution standards has an oily appearance. The irregular concentrations measured from CE system and the poor lower detection range at 0,1 mg/ml are due to the stock solution insolubility which effect the standard samples and the outcome. Using a fully diluted stock solution at 1.2 mg/ml a more liner calibration curve for 2- EHA fig. 4.14 was formed, it also improved the lower detection limit to 0,024 mg/ml fig. 4.12. At 0,024 mg/ml the peak is barely visible therefore a peak at lower concentration than 0,024 mg/ml will be too small to determine a reliable result considering the noise in the baseline that occurs in CE system.

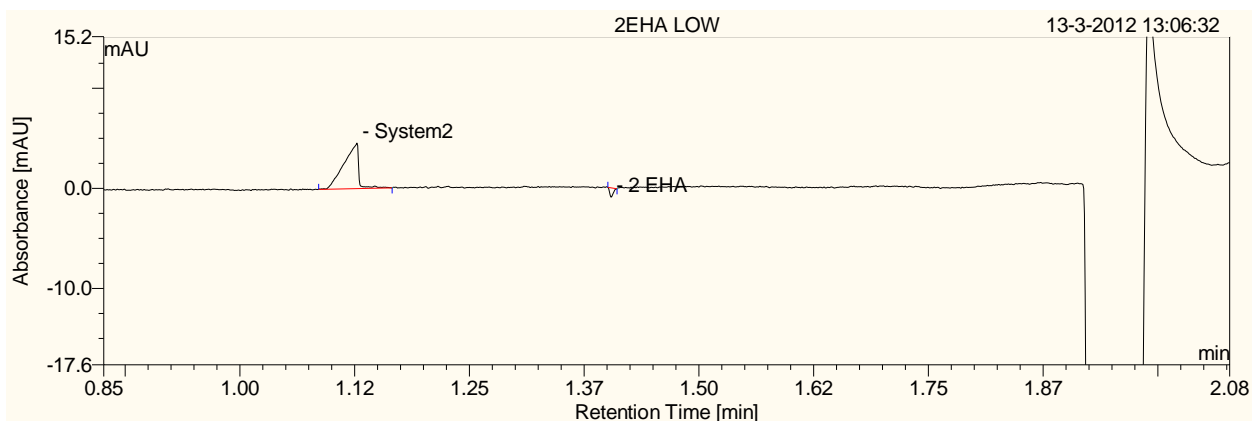

Fig. 4.12, Electroferogram of 2- EHA Standard solution of 0,024 mg/ml with 10 mM phthalic acid buffer solution and 40mg EDTA addition, pH adjustment to 9,1 with diethanolamin, fused silica capillary of 50 μ m i.d. and 50 cm long (41,5 effective length) temp 30 $^{\circ}$ C, Pressure injection at 50 mbar for 5 sec and detection wavelength at 229 nm were used. A small 2-EHA peak was detected.

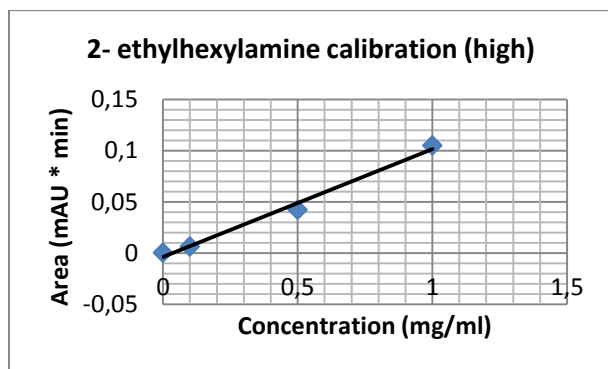

Fig. 4.13 show the calibration curve for 2- EHA using a 10 mg/ml stock solution. The measuring concentration at 1, 0,5, 0,1, 0,05 and 0,01 mg/ml (full size calibration curve can be found in appendix 6).

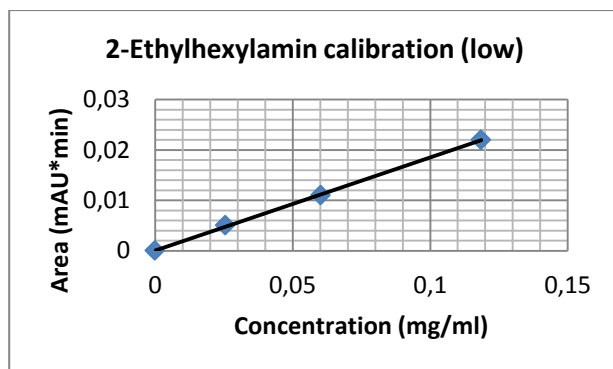

Fig. 4.14 show the calibration curve for 2- EHA using a 1,2 mg/ml stock solution. The measuring concentration at 0,12, 0,06 and 0,024 mg/ml (full size calibration curve can be found in appendix 7).

Sample of Ampholak YJH 40 runs show no trace of 2-EHA in the sample fig 4.15. Due to the concentration in the sample is less than the lower detection limit for 2- EHA. The samples containing 2-EHA in range of 0,01 to 0,02 % was diluted to 0,0002 mg/ml which is below the reliable detectable concentration (0,024 mg/ml). Result from the sample runs are not detectable with current condition, concentration of Ampholak YJH 40 samples needs to amplify to fit the detection range or more suitable buffer for 2-EHA (Wätzig, Degenhardt, & Kunkel, 1998).

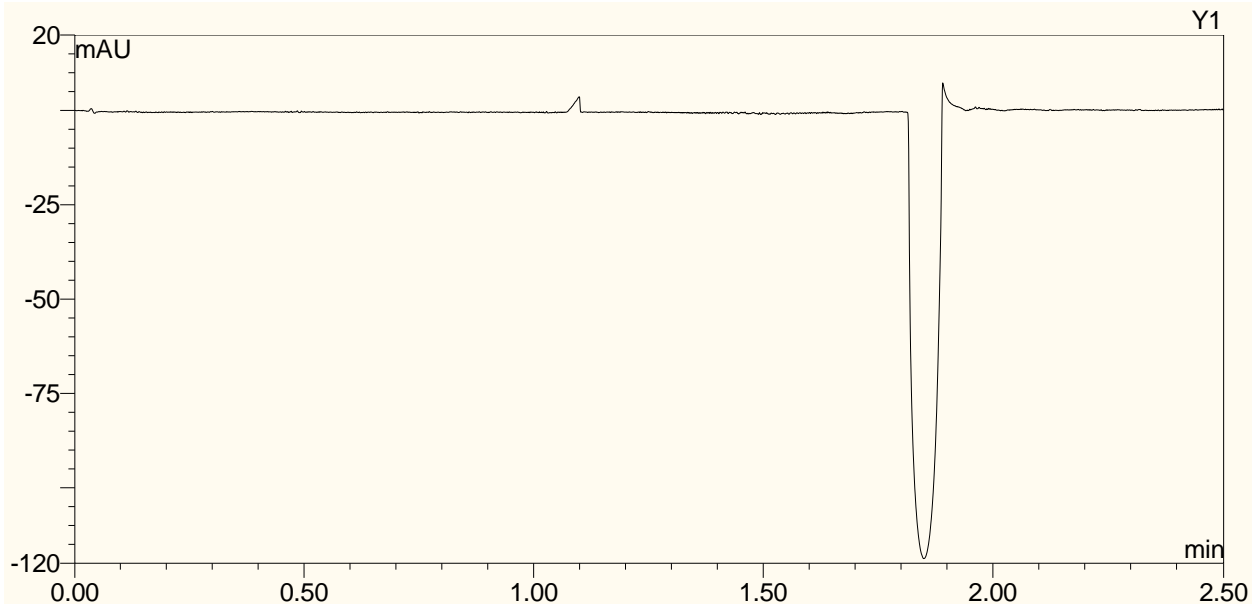

Fig. 4.15, Electropherogram of Ampholak JYH 40 sample with 10 mM phthalic acid buffer solution and 40mg EDTA addition, pH adjustment to 9,1 with diethanolamin, fused silica capillary of 50 μm i.d. and 50 cm long (41,5 effective length) temp 30 $^{\circ}\text{C}$, Pressure injection at 50 mbar for 5 sec and detection wavelength at 229 nm were used. No 2-EHA was detected hence 2-EHA concentration in the sample was below the detection limit of 0,024 mg/ml

Elektrokinetic sample injection (EKI) and various wavelengths of 210, 229, 240, 250 and 230 nm was tested to scan for resolution improvement in 2-EHA. The result indicates that the optimal detection wavelength is at 210 nm (black line) which stands out from other wavelengths fig. 4.16. In the electropherogram 2-EHA peak weakly appeared at signal 210 nm where 2-EHA peak could not be located in other wavelength.

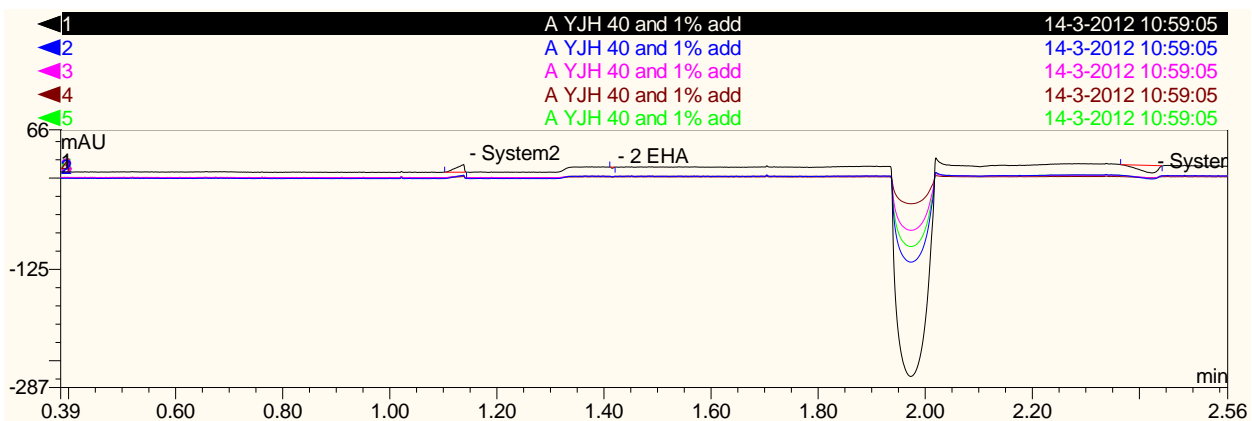

Fig 4.16, Electropherogram of Ampholak JYH 40 sample with 0,01 mg/ml 2-EHA addition, using 10 mM phthalic acid buffer solution and 40mg EDTA additive, pH adjustment to 9,1 with diethanolamin, fused silica capillary of 50 μm i.d. and 50 cm long (41,5 effective length) temp 30 $^{\circ}\text{C}$, Pressure injection at 50 mbar for 5 sec and multisignals detection at 210 (black), 229 (blue), 230 (green), 240 (pink), and 250 (brown) nm were used. 2-EHA peaks was located only at signal 210.

Furthermore an elektrokinetic injection of Ampholak YJH 40 sample with the addition of 0,01mg/ml 2-EHA was tested in the CE system to investigate improvement in resolution for 2-EHA peak. EKI selectively injected positively charge ions in into the capillary, ions that's negatively charge is not selected and remain in the solution. The electropherogram in fig. 4.17 shows a visible peak of 2-EHA addition in Ampholak JYH 40 sample. With EKI injection method the peak resolution was amplified and the peak is more visible compare to pressure injection technique, peak of low concentration of 0,005 mg/ml 2-EHA (below detection limit using hydrodynamic injection) was detected. The area unit data obtain from electropherogram showed a relatively proportioned concentration vs. area unit in table 4.3. The result measured 0,001 mg/ml peak was not fully reliable hence the peak is too small therefore the lower detection limit for IKE in this experiment was determined to 0,005 mg/ml.

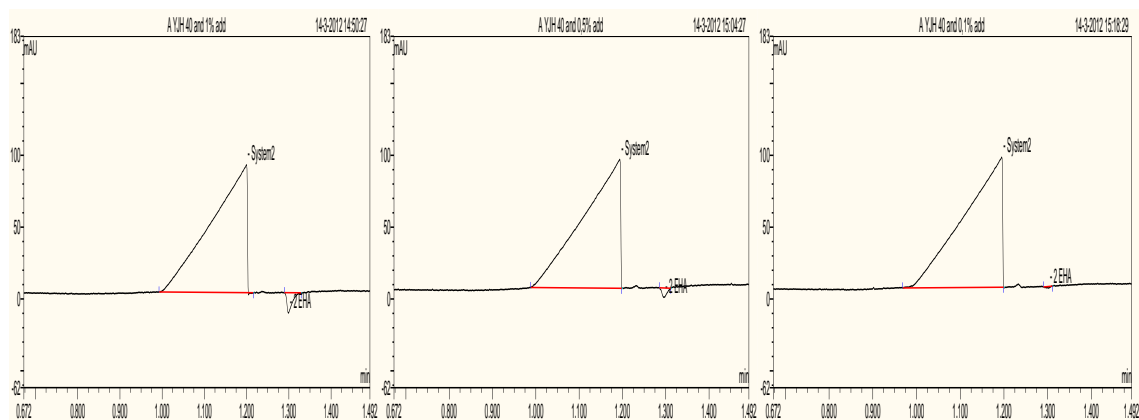

Fig. 4.17, Electropherogram of Ampholak JYH 40 sample with with 0,01 mg/ml (left), 0,005mg/ml (mid) and 0,001mg/ml (right) 2-EHA addition, using 10 mM phthalic acid buffer solution and 40mg EDTA addition, pH adjustment to 9,1 with diethanolamin, fused silica capillary of 50 μ m i.d. and 50 cm long (41,5 effective length) temp 30 $^{\circ}$ C, EKI injection at 25 kv for 10 sec and detection wavelength at 210 nm were used. 2-EHA peak was detectable at in all three samples. The lower detection limit was set to 0,005 mg/ml since the peak in 0,001 mg/ml was too small and not so reliable due to noise interference that occasionally accrued in CE system.

Table 4.3, Data collected from Chromeleon (editing program) showing relation between concentration and area unit.

Concentration added (mg/ml)	Area Unit (mAU* min)
0,01	0,084
0,005	0,041

Result of 2-EHA in the product was not obtainable due to low concentration the total runtime was 28 min which included runtime of five standards (10 min total), double analysis of the product sample (4 min total) and postrun time for every run (14 min total). Sample preparation was done within 5 min and standard preparation 15 min.

4.4. Result of acrylic acid and 2- ethylhexylamine mixture

As mention earlier in the report the quality control for Ampholak YJH 40 consist of quantification of both AA and 2- EHA in the product. For the CE system to be a time beneficial method it was desirable to gain result on both species in a single run. Therefore a sample consisting mixture of both AA and 2-EHA was made for the test run, making sure that the two species in the sample is detectable. Using the original buffer the result from both AA and 2- EHA was obtainable within 7 min run time (fig. 4.18).

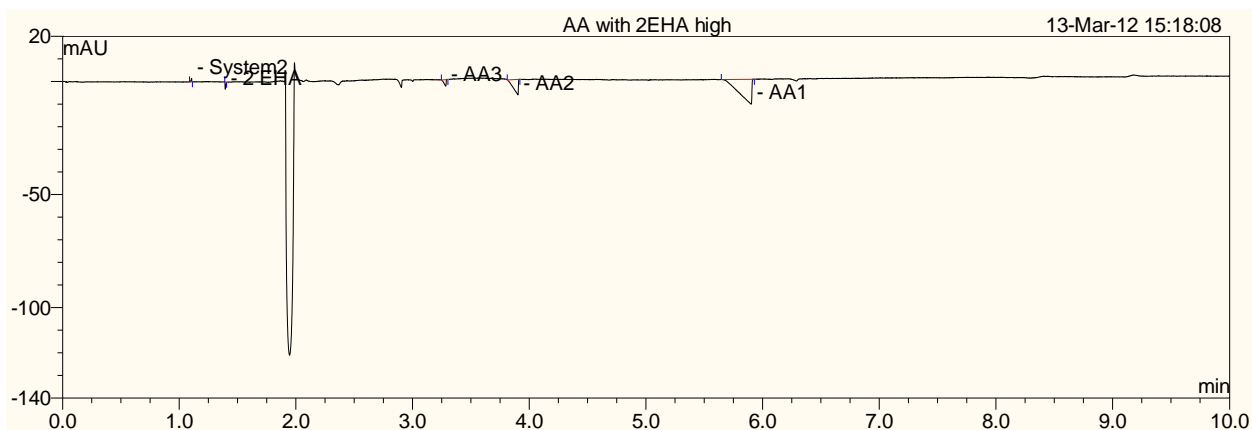

Fig 4.18, Electropherogram of a mixture of AA (0,173 mg/ml) and 2-EHA (0,117 mg/ml) sample with 10 mM phthalic acid buffer solution and 40mg EDTA addition, pH adjustment to 9,1 with diethanolamin, fused silica capillary of 50 μ m i.d. and 50 cm long (41,5 effective length) temp 30 $^{\circ}$ C, Pressure injection at 50 mbar for 5 sec and detection wavelength at 229 nm were used. Both AA and 2-EHA was detectable within 7 min run.

The result (area) acquired from the multi species run (AA and 2-EHA) was compared to the concentration of each substances. In table 4.4 AA area unit from the mixture test are being compared with area unit from pure AA test. The concentrations in the table are calculated using the equation below.

$$\frac{AM_{AA1}}{A_{AA1}} * C_{AA1} = CM_{AA1}, \quad (4.1)$$

Where

AM_{AA1} = Area unit of AA1 in mixture

A_{AA1} = Area unit of AA1

C_{AA1} = AA1 concentration

CM_{AA1} = AA1 concentration in the mixture

Only data from peak AA1 are taken into consideration the result from peaks AA2 and AA3 are excluded in this experiment. Result in table is relatively accurate beside at concentration of 0,173 mg/ml (first sample). The result from the mix sample (AM_{AA1}) shows a 6,3 % greater area unit than a pure AA sample (A_{AA1}) which is affected due mistake in sample preparation.

Table 4.4, Result from a AA run and a sample of AA and 2- EHA in a mixture. Only peak AA1 were investigated. Where AM_{AA1} = Area unit of AA1 in mixture, A_{AA1} = Area unit of AA1, C_{AA1} = AA1 concentration, CM_{AA1} = AA1 concentration in the mixture.

C_{AA1} (mg/ml)	CM_{AA1} (mg/ml)	A_{AA1} (aMU*min)	AM_{AA1} (aMU*min)
	$(\frac{AM_{AA1}}{A_{AA1}} * C_{AA1} = CM_{AA1})$		
0,173	0,184	1,242	1,320
0,086	0,085	0,687	0,677
0,017	0,017	0,151	0,151

Results from 2- EHA peaks were small compare to the AA peaks. The resolution for the peaks is low and small changes in the peaks lead to larger changes in concentration calculated in table 4.5. Concentrations were calculated using the equation (4.2) below.

$$\frac{AM_{2EHA}}{A_{2EHA}} * C_{2EHA} = CM_{2EHA}, \quad (4.2)$$

Where

AM_{2EHA} = Area unit of 2-EHA in mixture

A_{2EHA} = Area unit of 2-EHA

C_{2EHA} = 2-EHA concentration

CM_{2EHA} = 2-EHA concentration in the mixture

Table 4.5, Result from a 2-EHA run and a sample of AA and 2- EHA in a mixture where, AM_{2EHA} = Area unit of 2-EHA in mixture, A_{2EHA} = Area unit of 2-EHA, C_{2EHA} = 2-EHA concentration, CM_{2EHA} = 2-EHA concentration in the mixture.

C_{2EHA} (mg/ml)	CM_{2EHA} (mg/ml)	A_{2EHA} (aMU*min)	AM_{2EHA} (aMU*min)
	$(\frac{AM_{2EHA}}{A_{2EHA}} * C_{2EHA} = CM_{2EHA})$		
0,117	0,122	0,022	0,023
0,058	0,063	0,011	0,012
0,023	0,0184	0,005	0,004

5. Conclusion

The result shows that Capillary electrophoresis (CE) system with indirect UV detection can detect (phosphoric acid) PA, (acrylic acid) AA and 2-ethylhexylamine (2-EHA) in standard solutions using a 9,1 pH buffer. A 10 mg/ml stock solution AA concentration interval between 0,01 to 0,5 mg/ml display a linear calibration curve. PA calibration curve is linear at 0,01 to 1 mg/ml using 10 mg/ml stock solution. 2-EHA is soluble at 1,6 mg/ml therefore a solution of 10 mg/ml is not appropriate as stock solution. This leads to reduce quality of calibration curve and poor lower detection limit. Stock solution of 1 mg/ml 2-EHA with standard solution of 0,024 to 0,1 mg/ml is a suitable concentration level that provide a linear calibration curve. Result indicates that using hydrodynamic injection (HDI) method; linear calibration curve is obtainable for all three substances at given concentration interval.

Two different types of injection method is tested for 2-EHA to gain improvement in respond signal. Result indicates that EKI gives better resolution in signal; 2-EHA peak is more visible and detectable at 0,005 mg/ml which is below the lower detection limit for HDI method. Multiply diode-array detection (DAD) signals of 210, 229, 230, 240, and 250 nm is tested. Result shows that signal 210 nm give better respond compare to other tested signals. Conclusion is 2-EHA respond signal can be improve using detector setting at 210 nm with Elektrokinetic injection (EKI) mode.

Sample containing both AA and 2-EHA is tested to see if they can be detected in a single run. Result shows that within 7 min runtime CE is able to separate AA and 2-EHA in the sample using HDI mode. Even though EKI mode contribute to better signal resolution for 2-EHA, it is not suitable since its selecting 2-EHA (cation) in the sample therefore the amount of AA (anion) injected into the capillary is next to none. No result of AA is obtainable using EKI mode. Result of both species is obtainable in one run which reduce the run time for Ampholak YJH 40 quality control. Quality of 2-EHA peak is being compromise when using HDI mode which is a down side in multi species run.

Result indicates that lower buffer concentration (50%) shorten the run time for both PA and AA. PAs runtime with non-diluted buffer is > 10 min, when switching to 50% diluted buffer the result of PA is obtainable within 6 min. Using the 50% diluted buffer AA runtime is reduce to 3,5 min instead of 6,5 min. Result of 2-EHA is obtain within 2 min runtime using the non-diluted buffer.

Six test samples in the experiment was used to investigate and compared with an existing method of HPLC and UV-spectrometry. CE obtains a lower level of PA and AA compare to an established method use in quality control. Test sample in the experiment requires no pretreatment and therefore the effect from chemicals addition can be excluded. Ampholak YJH 40 test samples show no trace of 2-EHA since the concentration in the sample is below the lower detection limit.

Result of 2-EHA is obtainable after 50 min, 60 min for AA and 80 min for PA. This includes sample preparation and run time for each species. Result indicates that CE requires less time to analyze compare to the existing method, which is beneficial for product quality control process. More data and research is needed in developing a solid CE method. Result from this experiment show promising future for CE application in surface chemistry in Stenungsund. Suggestion of method development and further work will be discusses in upcoming chapter.

6. Further work and improvement

Suggestion of further application of CE system to surfactant is discussed in this section. In quality control and analytical aspect CE is suitable for many analytes. As mentioned earlier CE's wide range of application, short analysis time and simple sample preparation which make it an attractive method for quality control in production. In Akzo Nobel Surfactant numerous control checks of newly produced product occur on a daily basis. Suggestion on further research is based on various documentation and reports of CE-system and its applications.

6.1. Suggestion in improving phosphoric acid analyses with CE

Alternative method to analyse phosphoric acid in solution is to use direct UV detection (260 nm) with running electrolyte consisting of 3 mM $\text{Na}_2\text{MoO}_4 \cdot 2\text{H}_2\text{O}$ (Mo(VI)), 0,05M malonate buffer (pH3) and 45% acetonitrile (CH_3CN) for in-capillary complexation. Results of phosphonate, phosphate and diphosphate in tap water can be acquired with more than ten times higher sensitivity compared to indirect UV detection (Himeno, Inazuma, & Kitano, 2007). Improvement in sensitivity can be made in altering the buffer solution (should fix the double peaks issue), choice of detection and running conditions (Wätzig, Degenhardt, & Kunkel, 1998).

6.2. Suggestion in improving 2-Ethylhexylamine analyses with CE

To gain higher signal of 2-EHA various adjustments are done in the experiment. There is some improvement to the signal but more can be done to optimize the signal level. For example study how much higher concentrated product sample can be done before the peaks are misshaped or inseparable, instead of 0,1g/100ml which 2-EHA is not detectable due to low concentration sample. Increase injection time or altering the BGE to increase conductivity differences between buffer and sample, for example lower the buffer concentration or replace it with a better suited buffer. Reverse phase is another option in lowering the EOF which causes 2-EHA to remain longer in the detection window and therefore increasing the detection time (Agilent Technologies, 2000) (Heiger, 2000).

6.3. Surfactants analyses with CE

Beside AA, PA and 2-EHA analyses there are other species that CE method is suitable for. According to article "Determination of surfactants by capillary electrophoresis" CE system is able to perform a high resolution separation of active content in surfactants (anion, cation) and nonionic surfactants creating a characteristic fingerprint for surfactant mixtures. Single surfactant can be identified and quantified and with more research CE could be a fitting choice for quality control routine of active content in surfactant (Heinig & Vogt, 1999). Conditions of various settings, CE modes, electrolyte and detection are presented in the report which will be a great aid in further method development.

More information on analysis of cationic surfactants to aid further research is described in “Analysis of cationic surfactant by capillary electrophoresis” which uses CZE separation mode with direct UV detection to obtain quantitative and qualitative analyses using tetrahydrofuran addition in buffer system to prevent analyte from absorbing into the capillary (common problems with surfactant analyses in CE system) (Piera, Erra, & Infante, 1997).

Determination of amphoteric surfactants in a detergent is achievable through indirect UV detection. Mixture of amphoteric surfactants was fully separated within 17 min (Koike, Kitagawa, & Otsuka, 2007). Study in determination of cationic and anionic in a single run with dual-opposite injection is worth looking at for further development (Priego-Capote & Luque de Castro, 2005). The report is at starting point, further development require more research if such method is desirable.

There are advancements in nonaqueous capillary electrophoresis (NACE) show promising in separation of neutral species such as surfactants and fatty alcohol ethoxylates. NACE can be used in combination with wide bore capillary with extended optical path length which improves the detection sensitivity (Hong, Bai-Qing, & Tian-Yan, 2010). NACE is base BGE prepared from a pure organic solvents e.g. methanol, ethanol, dimethylsulphoxide, acetone and acetonitrile. This offer solubility for compounds that’s insoluble in water or aqueous carrier. Furthermore organic solven properties can improve separation factor and resolution (Vaher & Koel, 2005).

Alternative method to analyze active content in surfactant should be further developed since the existing method (photometric titration) is not suitable for all surfactant (result vary) plus there are factor that’s affecting the outcome such as sample handling (many step involve in sample preparation). There are issues for further development of the “photometric method” and spare part of photometric titration is no longer manufactured. CE could be the next step in the development of active content detection for Akzo Nobel.

6.4. Dimethylamine analyses with CE

Determination of Dimethylamine (DMA) in quality control is currently using a distillation method (Kjeldahl) which involves a time consuming sample preparation steps before the titration. CE once again offers a fast and simple sample preparation alternative. With indirect UV- detection DMA in fish was able to determent and separated within 5- 10 min using buffer containing 4 mM formic acid, 5mM copper (II) sulfate, and 3 mM crown (Timm & Jørgensen, 2002). Another alternative in DMA analyses with CE system is using contactless conductivity detection. Wide range of amine including DMA could be determent with contactless conductivity detection (CCD) which claims to improve the detection limit compare to indirect UV detection. This method require low conductivity buffer to prevent the joule heating effect. In this case acetic acid (25 mM, pH 3,0 or 0,5M pH 2,5) is an excellent choice of buffer. For more detailed description of the methods please refer to the reference report (Gong & Hauser, 2006).

6.5. Potassium and sodium analyses with CE

CE-system is known to be effective in determine inorganic ions this includes cations such as sodium ion (Na^+) and potassium ion (K^+). Current method to analyze Na and K in a surfactant sample is through atomic absorption spectroscopy (AAS) which is time consuming plus both ions have to analyze separately. CE offer an effective method that could detect both ions in a single run using fused silica capillary (65 cm total length 0,05mm i.d.), indirect UV-detection (214 nm) and hydrodynamic injection (8cm, 40 s). Background electrolyte (BGE) consist of 10 mM N,N-dimethylbenzylamine (DBA), 2 mM 18-crown-6, and 8 mM lactid acid pH 4,65 pH adjust with HNO_3). Result of 14 different inorganic cations in beverage can be determent within 7 min runtime using the settings mentioned (Fung & Lau, 2006). The inorganic ions are also detectable with CCD (Kubán, Kubán, & Kubán, 2002).

6.6. Nitrate and nitrite with CE

Determination of nitrate (NO_3^-) and nitrite (NO_2^-) is an uprising project in environmental monitoring on Akzo Nobel product therefore a rapid method with simple sample preparation is in high demand. CE- system fulfills the requirement needed for analysis of NO_3^- and NO_2^- . Analysis done with EKI injection, untreated silica capillary at 27 total length (20 effective length), direct UV-Detection (214 nm), and 20 mM phosphate buffer provides a rapid separation (8 sec) method for determination of NO_3^- and NO_2^- . Detection limit is set as 6.2 ppb for NO_3^- and 46 ppb for NO_2^- (Melanson & Lucy, 2000) which is below 1 ppm the require detection limit for Akzo Nobel products.

7. Acknowledgment

To Carina Evertse for letting me use the laboratory to conduct the experiment and your expertise guidance in CE. To Rolf Arvidsson for letting me be a part of this highly anticipated CE project which is now in process for further development. It open a new field of analytical method for me. To Gunnar Westman the examiner and supervisor. Thanks to Akzo Nobel laboratory in deventer for letting me borrow the equipment and providing me with the resources. Thanks to Akzo Nobel analytical department in Stenungsund for the financial support for the trip to Deventer, guidance, and the warm welcome. Thank to everyone that supported me through the process.

8. Abbreviations

2-EHA	2- Ethylhexylamine
AA	Acrylic acid
AAS	Atomic absorption spectroscopy
BGE	Background electrolyte
CCD	Contactless conductivity detector
CE	Capillary electrophoreses
CMC	Critical micelle concentration
DAD	Diode-array detection
DMA	Dimethylamine
EKI	Elektrokinetic injection
EO	Ethylene Oxide
EOF	Electro-osmotic flow
HDI	Hydrodynamic injection
HPCE	High performance capillary electrophoresis
HPLC	High performance liquid chromatography
PA	Phosphoric acid
pI	Isoelectric point
QCL	Quality control laboratory
R&D	Research and development
SDS	Sodium doecylsulfate

9. Referents

Agilent Technologies. (2000). *Agilent Capillary Electrophoresis System User's Guide*. Germany: Agilent.

Agilent Technologies. (2000). The comprehensive, interactive tools for users of CE. *Agilent technologies CD-ROM*. Agilent technologies.

BASF Corporation, Celanese, Ltd., Elf Atochem North America, Inc., Rohm & Haas Company, Union Carbide Corporation. (u.d.). *ACRYLIC ACID*. Hämtat från DOW: <http://www.dow.com> den 08 05 2012

Deeb, S. E., Iriban, M. A., & Gust, R. (2011). MEKC as a powerful growing analytical technique. *Electrophoresis*, 32, 166–183.

Fainerman, V., Möbius, D., & Miller, R. (2001). *Surfactants [electronic resource]: chemistry, interfacial properties, applications*. Amsterdam ; New York: Elsevier Science.

Fung, Y., & Lau, K. (2006). Separation and determination of cations in beverage products by capillary zone electrophoresis. *Journal of Chromatography A*, 1118, 144–150.

Gong, X., & Hauser, P. (2006). Determination of different classes of amines with capillary zone electrophoresis and contactless conductivity detection. *Electrophoresis*, 27, 468–473.

Hargreaves, T. (2003). *CHEMICAL FORMULATION, An Overview of Surfactant-based Preparations Used in Everyday Life*. Cambridge, UK: The Royal Society of Chemistry.

Heiger, D. (2000). *High performance capillary electrophoresis: An introduction*. Germany: Agilent Technologies.

Heinig, K., & Vogt, C. (1999). Determination of surfactant by capillary electrophoresis. *Electrophoresis*, 20, 3311-3328.

Himeno, S., Inazuma, N., & Kitano, E. (2007). Simultaneous determination of phosphonate, phosphate, and diphosphate by capillary electrophoresis using in-capillary complexation with Mo(VI). *Journal of separation science vol. 30, issue 7*, 1077-1081.

Hong, T., Bai-Qing, Y., & Tian-Yan, Y. (2010). Recent Advances in Application of Nonaqueous Capillary Electrophoresis. *CHINESE JOURNAL OF ANALYTICAL CHEMISTRY Volume 38, Issue 11, November*, 1670–1677.

Klampfl, C. W., Katzmay, M. U., & Buchberger, W. (1998). Separation of inorganic and organic anions by capillary zone electrophoresis with simultaneous indirect UV and conductivity detection. *Electrophoresis*, 19, 2459-2464.

Koike, R., Kitagawa, F., & Otsuka, K. (2007). Simultaneous determination of amphoteric surfactants in detergents by capillary electrophoresis with indirect UV detection. *Journal of Chromatography A*, 1139, 136–142.

- Kosswig, K. (2000). Surfactant. *Ullmann's Encyclopedia of Industrial Chemistry*, 431-501.
- Kubán, P., Kubán, P., & Kubán, V. (2002). Simultaneous determination of inorganic and organic anions, alkali, alkaline earth and transition metal cations by capillary electrophoresis with contactless conductometric detection. *Electrophoresis*, 23, 3725–3734.
- Melanson, J., & Lucy, C. (2000). Ultra-rapid analysis of nitrate and nitrite by capillary electrophoresis. *Journal of Chromatography A*, 884, 311–316.
- Nobelprize.org. (1948). *The Nobel Prize in Chemistry 1948 Arne Tiselius*. Hämtat från Nobelprize.org: http://www.nobelprize.org/nobel_prizes/chemistry/laureates/1948/tiselius-bio.html den 1 April 2012
- Piera, E., Erra, P., & Infante, M. R. (1997). Analysis of cationic surfactants by capillary electrophoresis. *Journal of Chromatography A*, 275-280.
- PQC Akzo Nobel. (2010). *Ampholak YJH 40 Körningsföreskrift*. Hämtat från Akzo Nobel Surfactant: www.one.akzonobel.intra den 08 05 2012
- PQC Akzo Nobel. (den 05 02 2009). *Körningsföreskrift för Phospholan PE65*. Hämtat från Akzo Nobel Surfactant: <http://one.akzonobel.intra> den 08 05 2012
- Priego-Capote, F., & Luque de Castro, M. D. (2005). Dual-opposite injection capillary electrophoresis for the determination of anionic and cationic homologous surfactants in a single run. *Electrophoresis*, 26, 2283-2292.
- Rosen, M. J., & Kunjappu, J. (2012). *Surfactants and Interfacial Phenomena*. New Jersey: John Wiley & Sons.
- Schramm, L. L. (2008). *Surfactant*. Hämtat från AccessScience: <http://www.accessscience.com>. den 4 05 2011
- Silva, M. (2007). MEKC: An update focusing on practical aspects. *Electrophoresis*, 28, 174–192.
- Tagliaro, F., Manetto, G., Crivellente, F., & Smith, F. (1998). A brief introduction to capillary electrophoresis. *Forensic Science International* 92, 75-88.
- Timm, M., & Jørgensen, B. (2002). Simultaneous determination of ammonia, dimethylamine, trimethylamine and trimethylamine-*n*-oxide in fish extracts by capillary electrophoresis with indirect UV-detection. *Food Chemistry* 76, 509–518.
- Vaher, M., & Koel, M. (2005). Specific background electrolytes for nonaqueous capillary electrophoresis. *Journal of Chromatography A*, 1068, 83–88.
- Weinberger, R. (2000). *Practical Capillary Electrophoresis (Second Edition)*. San Diego, Calif.: Academic, cop.

Weston, A., & Brown, P. (1997). *HPLC and CE [electronic resource] : principles and practice* . San Diego: Academic Press.

Wätzig, H., Degenhardt, M., & Kunkel, A. (1998). Strategies for capillary electrophoresis: Method development and validation for pharmaceutical and biological applications. *Electrophoresis* , 19, 2695-2752.

Appendix 1: Buffer for HPCE

Table.Data (without modification) of various buffers pKa and mobility (Effective mobility for fully ionized buffers at 25°C) (Weinberger , 2000) .

BUFFER	pKa	Mobility($10^{-5} \text{ cm}^2/\text{v s}$)
ZWITTERIONIC BUFFERS		
Aspartate	1.99	+31.6
β -Alanine	3.55	+36.7
β -Alanine	10.24	-30.8
Histidine	9.34	+29.6
MES	6.13	-26.8
ACES	6.75	-31.3
MOPSO	6.79	-23.8
BES	7.16	-24.0
MOPS	7.2	-24.4
TES	7.45	-22.4
DIPSO	7.5	
HEPES	7.51	-21.8
TAPSO	7.58	
HEPPSO	7.9	-22.0
EPPS	7.9	
POPSO	7.9	
DEB	7.91	-26.2
Tricine	8.05	
Glygly	8.2	
Bicine	8.25	
TAPS	8.4	
CHES	9.55	
CAPS	10.4	
CONVENTIONAL (Nonzwitterionic) BUFFERS		
Citrate	3.12, 4.46, 6.40	-28.7 (low pKa value)
Formate	3.75	-56.6
Acetate	4.76	-42.4
Lactate	3.85	-35.8
Phosphate	2.14, 7.10, 13.3	-35.1 (low pKa value)
Borate	9.14	-40.0 (estimate)
Creatinine	4.89	+33.1

Appendix 2: Buffers additive

Table. Data of various buffer additive (without modification) and it uses for CE system (Weinberger , 2000).

Purpose	Reagent	Mechanism
To modify mobility	Transition metals	Complex formation
	Cyclodextrins	Inclusion complex
	Surfactants	Micelle interaction
	Organic solvents	Solvation
	Sulfonic acids	Ion-pair formation
	Quaternary amines	Ion-pair formation
	Borate	Complex with carbohydrates, diols
	Chelating agents	Complex formation with metals
	Crown ethers	Inclusion complex
	Macrocyclic antibiotics	Inclusion complex
	Calixarenes	Inclusion complex
	Dendrimers	Inclusion complex
To modify EOF	Cationic surfactant	Dynamic coating, EOF reversal
	Organic solvents	Affects viscosity
	Linear polymers	Dynamic coating
	Zwitterionic surfactant	Dynamic coating
To reduce wall effects	Cationic surfactant	Dynamic coating, EOF reversal
	Polyamines	Covers silanols
	Linear polymers	Dynamic coating
	Zwitterionic surfactant	Dynamic coating
To maintain solubility	Organic solvents	Hydrophobicity
	Urea	Iceberg effect

Appendix 3: Surfactant use in MEKC mode

Table, Data of surfactant (without modification) use in MEKC (Weston & Brown, 1997).

	Surfactant	Molecular formula	CMC (mM)
Anionic	Sodium decyl sulfate	$\text{CH}_3(\text{CH}_2)\text{OSO}_3^- \text{Na}^+$	8,1
	Sodium dodecyl sulfate (SDS)	$\text{CH}_3(\text{CH}_2)_{11}\text{OSO}_3^- \text{Na}^+$	-
	Sodium tetradecyl sulfate (STS)	$\text{CH}_3(\text{CH}_2)_{13}\text{OSO}_3^- \text{Na}^+$	2,1 (50°C)
	Sodium dodecyl sulfonate	$\text{CH}_3(\text{CH}_2)_{11}\text{SO}_3^- \text{Na}^+$	-
Cationic	Dodecyltrimethylammonium chloride (DTAC)	$\text{CH}_3(\text{CU}_2)_{11}\text{H}^+(\text{CU}_3)_3\text{Cl}^-$	16 (30°C)
	Dodecyltrimethylammonium bromide (DTAB)	$\text{CH}_3(\text{CH}_2)_{11}\text{N}^+(\text{CH}_3)_3\text{Br}^-$	15
	Cetyltrimethylammonium chloride (CTAC)	$\text{CH}_3(\text{CH}_2)_{15}\text{N}^+(\text{CH}_3)_3\text{Cl}^-$	-
	Cetyltrimethylammonium bromide (CTAB)	$\text{CH}_3(\text{CH}_2)_{15}\text{N}^+(\text{CH}_3)_3\text{Br}^-$	0,92
Non Ionic	Octylglucoside		-
	Triton X-100		0,24
Zwitterionic	3-[3-(Cholamidopropyl)dimethylammonio]-1-propanesulfonate (CHAPS)		8
Chiral surfactants	Digitonin		
	Sodium-N-dodecanoyl-L-valinate (SD Val)		5,7 (40°C)
Biological surfactants (Bile Salt surfactants)	Sodium cholate		13-15
	Sodium taurocholate		10-15

Appendix 4: Phosphate calibration curve

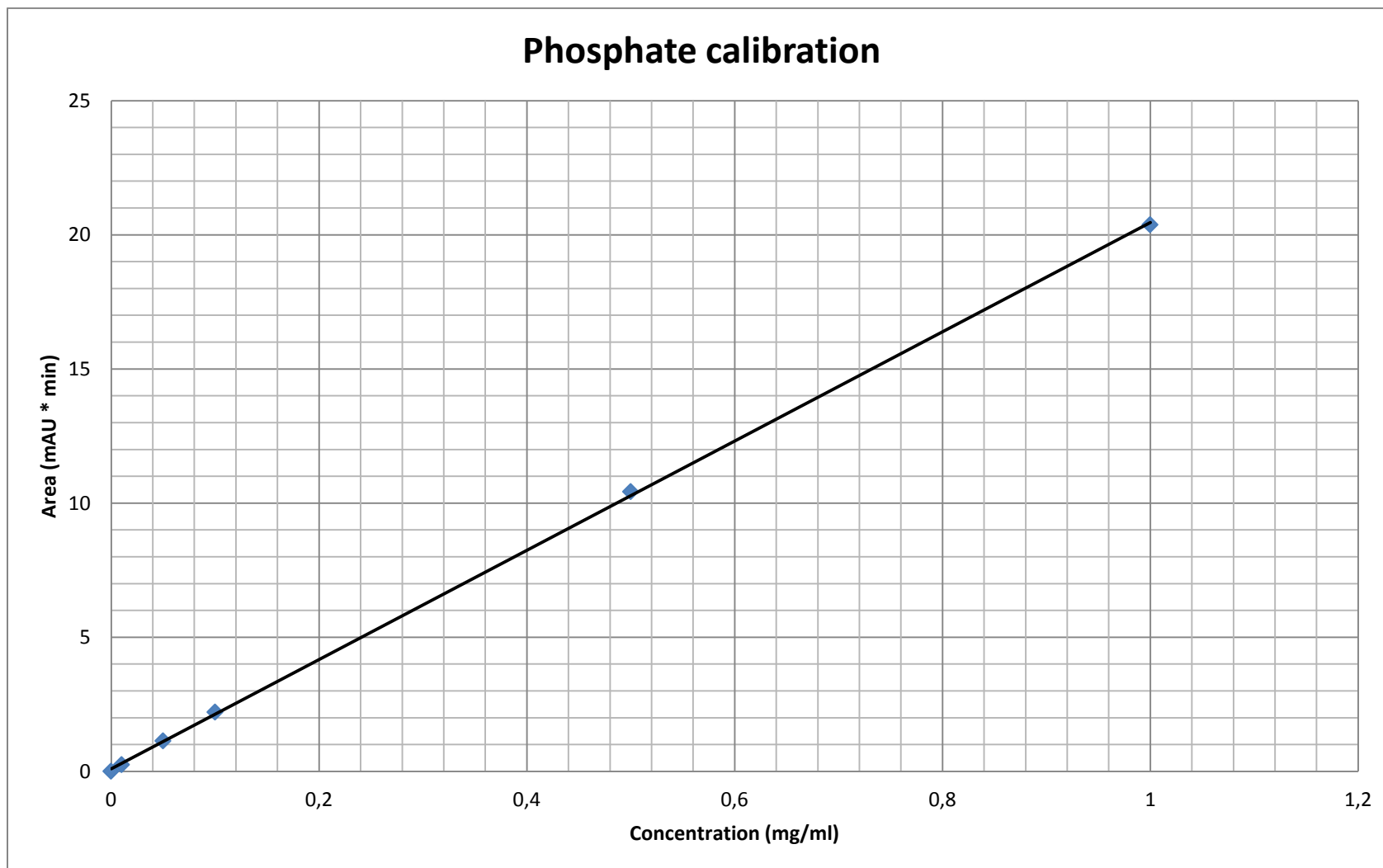

Appendix 5: Acrylic acid calibration curve

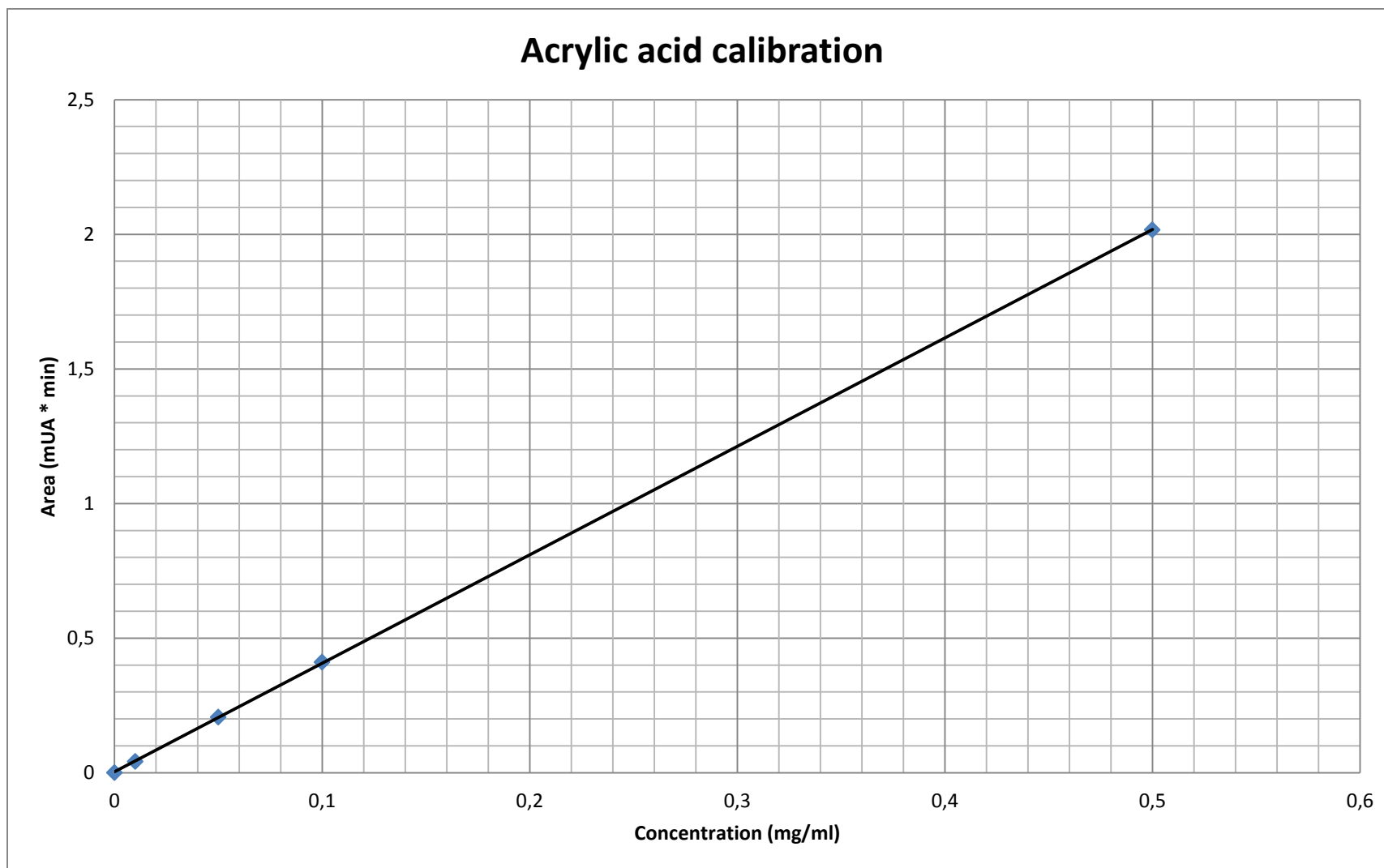

Appendix 6: 2-ethylhexylamine calibration curve from insoluble stock solution.

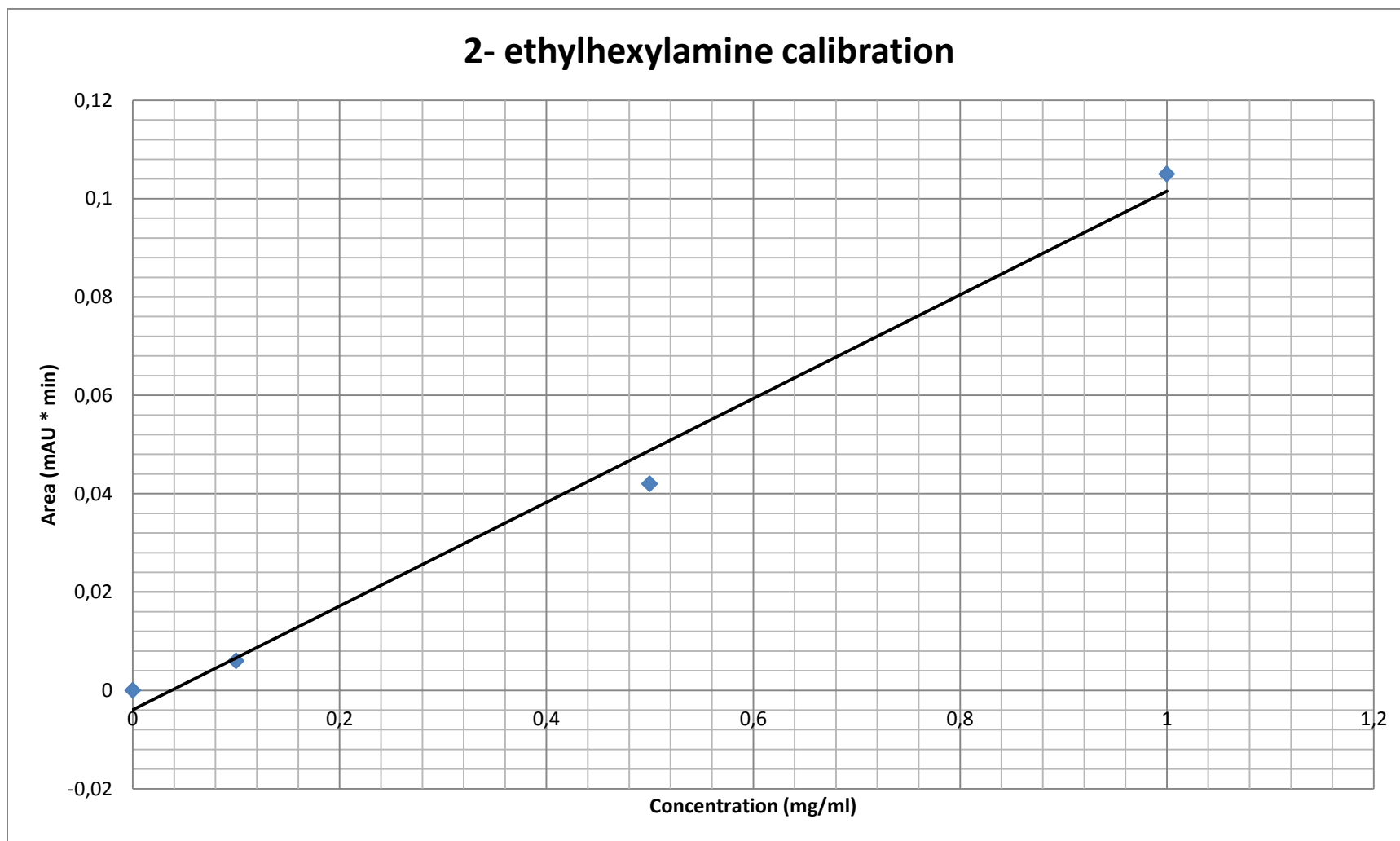

Appendix 7: 2-ethylhexylamine calibration curve from soluble stock solution.

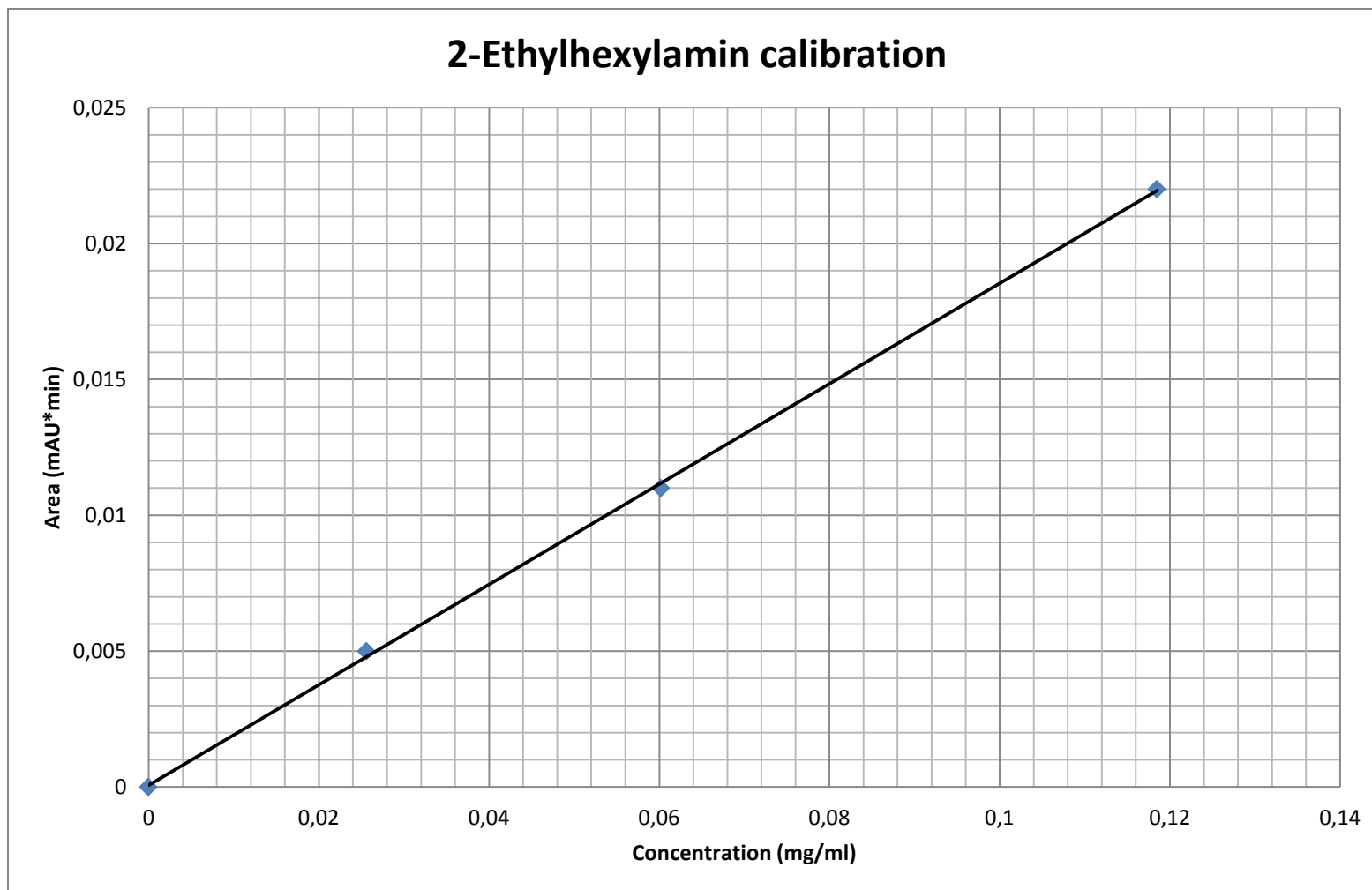

Chalmers University of Technology
SE-412 96 Gothenburg, Sweden
Telephone + 46 (0)31-772 1000
Web: www.chalmers.se