

# CHALMERS



## Design and study of the power grid influence of a single-phase 300 W PFC rectifier

*Master of Science thesis in power electronics*

Henrik Elofsson

Department of Energy and Environment  
*Division of Electric Power Engineering*  
CHALMERS UNIVERSITY OF TECHNOLOGY  
Göteborg, Sweden, 2009



Master of Science thesis in power electronics

**Design and study of the power grid  
influence of a single-phase 300 W PFC  
rectifier**

Henrik Elofsson

**CHALMERS**



Department of Energy and Environment  
*Division of Electric Power Engineering*  
Chalmers University of Technology  
SE-412 96 Göteborg, Sweden  
Göteborg, September 2009



# Design and study of the power grid influence of a single-phase 300 W PFC rectifier

Henrik Elofsson

September 14, 2009

## **Abstract**

This report deals with the problems that arises when the amount of plain single phase diode rectifiers on a power grid becomes too large. Different approaches to alleviate the problems is discussed. Judging on simulations, the active power factor correction seems the most promising method. An active power factor correction unit was built and brought into operation with fairly good results. In simulations the THD of the input current was reduced from 160% when no PFC was used to merely 8% when an active PFC was incorporated.

## Contents

<b>1</b>	<b>Introduction</b>	<b>1</b>
<b>2</b>	<b>Theoretical background</b>	<b>3</b>
2.1	What is EMI? . . . . .	3
2.2	Diode rectifiers . . . . .	3
2.3	Methods for reducing the EMI . . . . .	5
2.3.1	Designing for reduced EMI . . . . .	5
2.3.2	Resonant converters . . . . .	5
2.3.3	Power Factor Correction . . . . .	5
<b>3</b>	<b>Simulations</b>	<b>7</b>
3.1	Without PFC . . . . .	7
3.2	Passive PFC . . . . .	9
3.3	Active PFC . . . . .	11
<b>4</b>	<b>Construction and building</b>	<b>15</b>
<b>5</b>	<b>Measurements</b>	<b>19</b>
5.1	Without PFC . . . . .	19
5.2	Active PFC . . . . .	21
<b>6</b>	<b>Evaluation of the different topologies</b>	<b>23</b>
<b>7</b>	<b>Conclusions and discussion</b>	<b>25</b>
<b>8</b>	<b>Bibliography</b>	<b>27</b>

## List of Figures

1	Rectifier bridge. . . . .	3
2	Rectifier bridge with decoupling capacitor. . . . .	4
3	The voltages and currents of the above rectifiers. . . . .	4
4	Voltages and currents without PFC. . . . .	8
5	Frequency spectrum of the input current without PFC, $THD = 160\%$ . . . . .	8
6	Rectifier bridge with dc side inductor. . . . .	9
7	Voltages and currents with passive PFC. . . . .	9
8	Frequency spectrum of the input current with passive PFC, $THD = 90\%$ . . . . .	10
9	Rectifier bridge with boost converter. . . . .	11
10	Voltages and currents with active PFC, without EMI filter. . . . .	12
11	Frequency spectrum of the input current without EMI filter, $THD = 10\%$ . . . . .	12
12	Voltages and currents with active PFC, with EMI filter. . . . .	13
13	Frequency spectrum of the input current with EMI filter, $THD = 8\%$ . . . . .	13
14	Enlargement of a zero crossing of Figure 12. . . . .	14
15	Schematic of the PFC. . . . .	17
16	Board layout of the PFC. . . . .	18
17	The assembled PFC. . . . .	18
18	The measured current and voltage to the circuit without PFC. . . . .	19
19	FFT of the measured input current to the circuit without PFC, $THD = 260\%$ . . . . .	20
20	The modifications to the PFC. . . . .	21
21	The measured input current to the circuit with active PFC. . . . .	22
22	FFT of the measured input current to the circuit with active PFC, $THD = 100\%$ . . . . .	22





## 1 Introduction

The ratio between real power and apparent power is called power factor. It is desirable to keep a power factor of unity, because of the minimised current caused losses in the power grid that is then obtained. If the current and voltage is purely sinusoidal in shape, the power factor can be obtained as the cosine of the displacement angle between the current and the voltage. Capacitors can be added to adjust the power factor, as the load usually is inductive. This method only works with linear loads, as nonlinear loads produce distorted currents. In order to increase the power factor of such loads more advanced equipment than capacitors is needed. The current is reshaped into sinusoidal form using either a simple low pass filter or using power electronics. This report will show that the latter has several advantages, but it is more difficult to design.

An added advantage of reshaping the current is that the apparatus may inject less harmonic distortion into the power grid, thereby reducing the ElectroMagnetic Interference, EMI. Reducing the harmonics is often required to be able to comply to the rules of ElectroMagnetic Compatibility, EMC [1, page 487].

The goal of the work was to investigate the feasibility of using active power factor correction rectifiers at relatively low power levels and to verify the simulations with measurements.



## 2 Theoretical background

The voltage on the power grid in the ideal case is purely sinusoidal with the frequency 50 Hz and a voltage of 230 V. However, if large enough loads draw current that is out of phase with the voltage or if the current is non-sinusoidal, the grid voltage will be distorted due to the impedance of the grid [1, page 483].

### 2.1 What is EMI?

Electromagnetic interference is the influence different electric components have on each other. EMI exists in two different forms: conducted and radiated. Normally the conducted EMI is several times greater than the radiated. The radiated EMI can also be shielded away using metal casings [1, page 500]. EMI is generated whenever the voltage or current changes rapidly. Henceforth this report will only deal with conducted EMI.

### 2.2 Diode rectifiers

The most basic and commonly used rectifier is a line frequency diode rectifier. It is cheap and easy to design, with its most basic form shown in figure 1. The instantaneous dc-link voltage is the absolute value of the ac-link voltage, as can be seen in figure 3.

Often a decoupling capacitor is added in order to achieve a smooth dc-link voltage. This is illustrated in figure 2, and results in the dc link voltage shape seen in figure 3. Because of this capacitor the circuit only draws current from the grid when the capacitor is being charged, which is when the grid voltage is higher than the voltage in the capacitor. This leads to a greatly distorted current, as can be seen in figure 3.

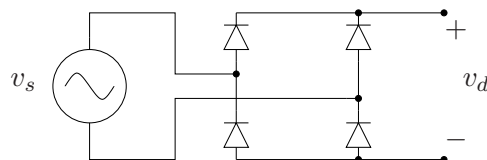

Figure 1: Rectifier bridge.

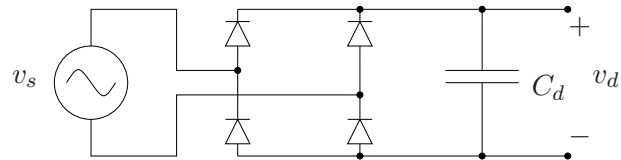

Figure 2: Rectifier bridge with decoupling capacitor.

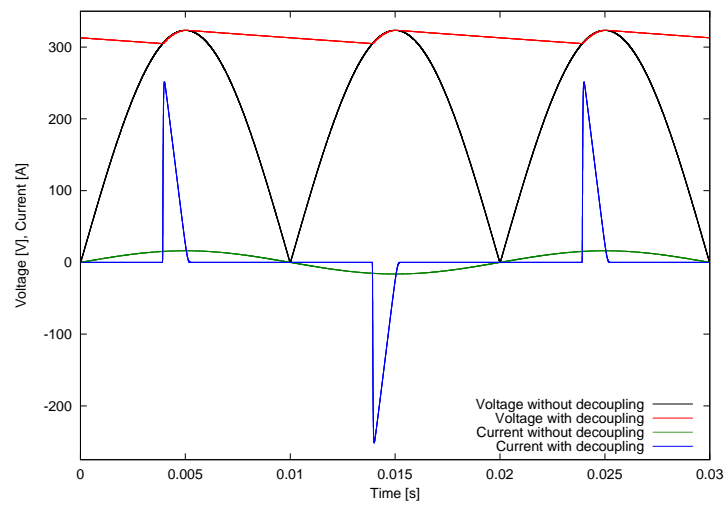

Figure 3: The voltages and currents of the above rectifiers.

## **2.3 Methods for reducing the EMI**

There are several different ways to reduce the EMI from a circuit. One possible solution is to design the circuit in such a way that it produces less EMI. Another is to limit the amount of EMI conducted to the net by using some sort of Power Factor Correction, PFC [1, page 488].

### **2.3.1 Designing for reduced EMI**

A common way to improve the design is to use snubbers to reduce large over-currents and over-voltages during switching. Snubbers are circuits that reduces transients, limits current or voltage derivatives or reshapes switching trajectories [1, page 669]. Reduced switching frequency also lead to decreased EMI, because of the reduced number of transitions per time unit. Minimising stray inductance by careful circuit layout is also important, as it is a source of unwanted oscillations and interference [1, page 722].

### **2.3.2 Resonant converters**

There is also the possibility to use soft switching, where the switching takes place at zero current och zero voltage. These so called resonant converters have the advantages of low  $dv/dt$  and  $di/dt$ , which reduces the switching losses as well as the EMI. This have the added benefit of making higher switching frequencies possible [1, page 249].

### **2.3.3 Power Factor Correction**

The simplest form of power factor correction is to add an inductor to the ac-link, acting as a low pass filter. A more advanced approach is to add power electronics that shapes the current using a regulator and switches of some kind.



### 3 Simulations

The simulations were made in LTspice/SwitcherCAD III, a free SPICE program. The reason for this is that there is a SPICE-model for a commercial power factor controller included in that program. Generally there is no SPICE-models available for PFC-controllers, so the choice was easy. Three different cases were simulated: without PFC, with passive PFC and with active PFC. A concept often used in this report is FFT, Fast Fourier Transform. It is a numerical method used to break up a sampled signal into its frequency components, and present these in a graph. Another concept used often is THD, Total Harmonic Distortion. The THD is a measure of how the distortion in the voltage or current is. It is usually presented as a percentage, but can also be in dB. The definition differs somewhat between different scientific fields, the version presented here is the one commonly used in power systems. One difference is that within the audio field the THD is defined to have a value between 0% and 100%, but with this definition the THD can exceed 100%. In the equation below  $I_h$  denotes the harmonic current with index  $h$ , and  $I_1$  is the root current.

$$THD = \sqrt{\sum_{h \neq 1} \left(\frac{I_h}{I_1}\right)^2} \quad (3.1)$$

#### 3.1 Without PFC

The circuit used in this simulation is the rectifier bridge with decoupling capacitor discussed in section 2.2. Usually the decoupling capacitor is designed to maintain a hold-up time equal to 1.5 times the period time of the line voltage. For 50 Hz this is 30 ms. The maximum allowed voltage ripple and the lifespan of the capacitor must also be considered [1, page 347].

The resulting current is only as bad as in figure 4 if the diodes are directly connected to the grid and not via a transformer. This is because a transformer has a considerable inductance which acts as a low pass filter on the input and makes for a smoother current. In modern equipment the transformer is avoided due to their size and weight, and switching converters is used instead. Figure 5 shows a frequency spectrum of the input current, with a large peak at 50 Hz, but also a lot of harmonics. This is no problem if the load is small compared to the capacity of the grid, as it will not be able to influence the grid in any significant way [1, page 486].

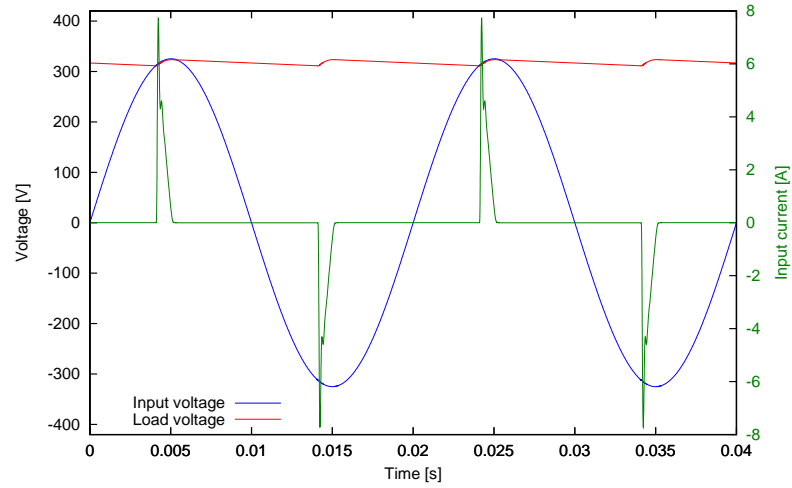
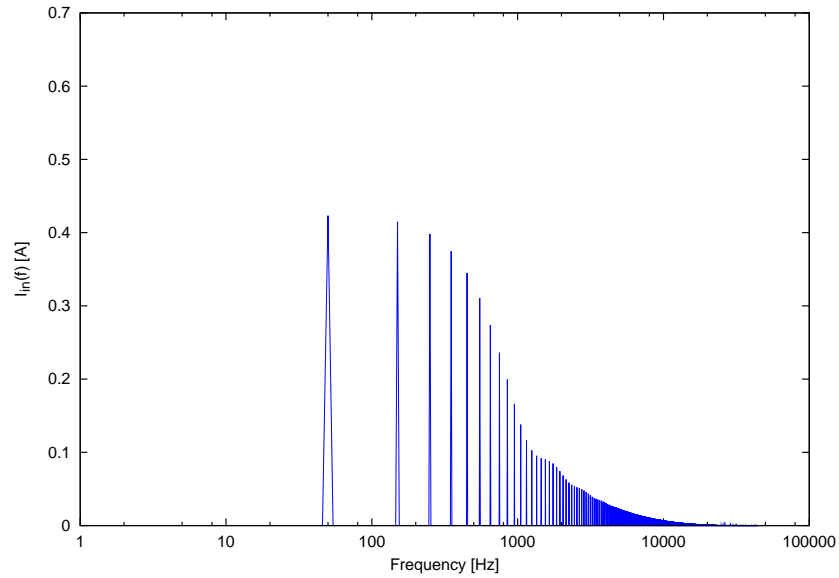

Figure 4: Voltages and currents without PFC.

Figure 5: Frequency spectrum of the input current without PFC,  $THD = 160\%$ .



### 3.2 Passive PFC

The passive PFC used is the simplest possible. It consists of the same rectifier bridge as in the previous simulation but with an inductor added. Passive PFCs can be made more advanced than this, one simple way is to add a low pass filter on the input side. It is also common to put a capacitor on the diode side of the inductor.

The current waveform is significantly enhanced, but is still far from sinusoidal. The FFT reveals that two large harmonics are still present, but there is not much energy left in the higher frequencies.

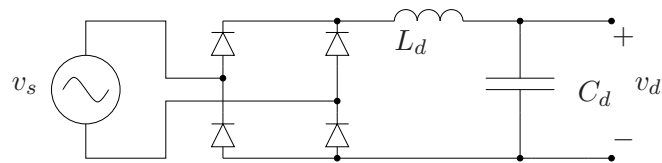

Figure 6: Rectifier bridge with dc side inductor.

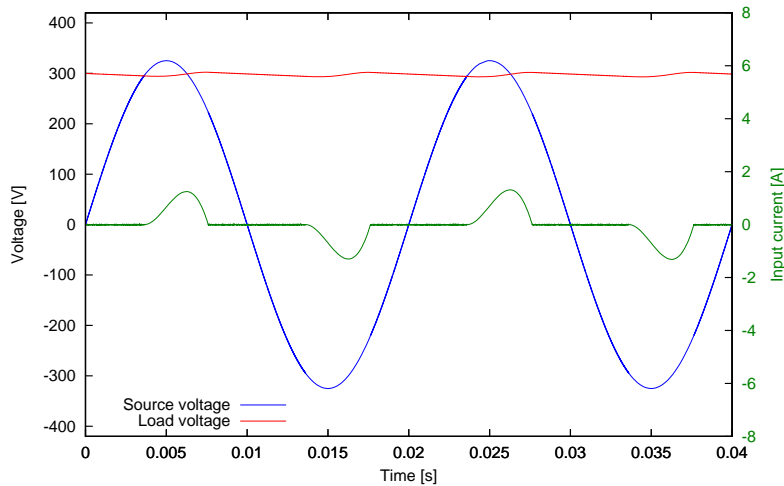

Figure 7: Voltages and currents with passive PFC.

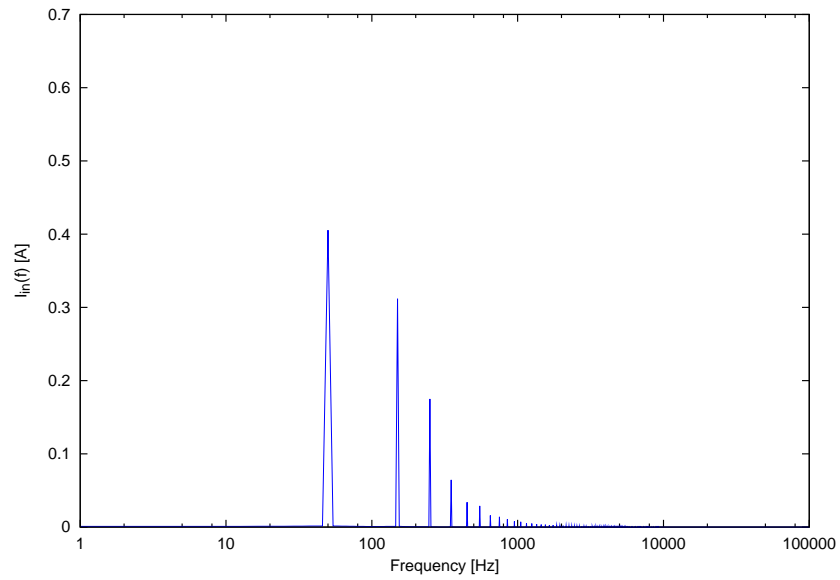

Figure 8: Frequency spectrum of the input current with passive PFC,  $THD = 90\%$ .

### 3.3 Active PFC

The active PFC is basically the same as the passive PFC, but with a switch and a diode added. These together with the coil forms a boost converter. A boost converter is a power electronic device that increases a dc voltage's level [1, page 172]. The converter is controlled in such a way that the current is sinusoidal. This is accomplished by charging the bulk capacitor to a voltage greater than the rectified input voltage. Then it is just a matter of increasing the output voltage from the converter to increase the charge current or vice versa to obtain the desired wave form. The output current from the PFC defines how high the maximum charging voltage needs to be.

In order to further enhance the current waveform a coupled coil was introduced at the grid terminal, which further enhanced the waveforms. This, together with Y-capacitors[6], is a standard design procedure to reduce EMI [1, page 502]. The waveform looks somewhat better because of this (figure 12), but the FFT (figure 13) does not change much. Compared to the FFT from the passive PFC (figure 8) there is a significant improvement, though. The only harmonic of any significance in both spectra's is the third, all other are reduced to a minimum.

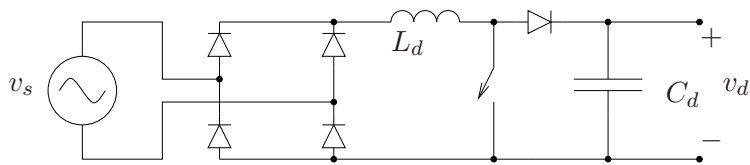

Figure 9: Rectifier bridge with boost converter.

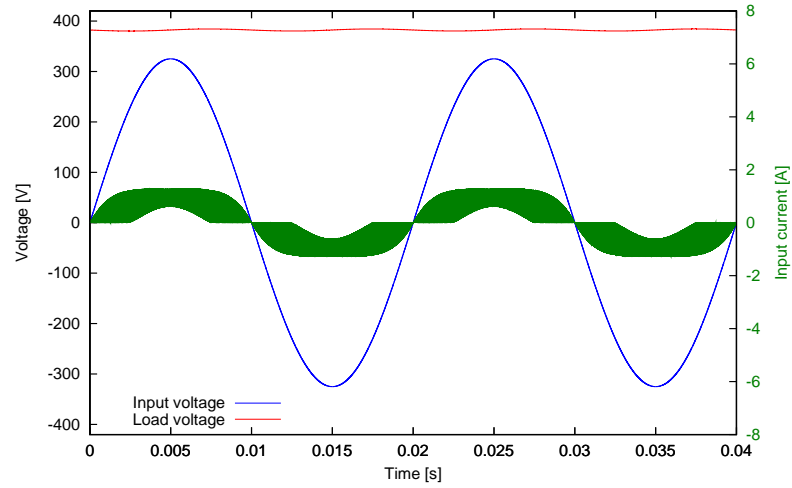

Figure 10: Voltages and currents with active PFC, without EMI filter.

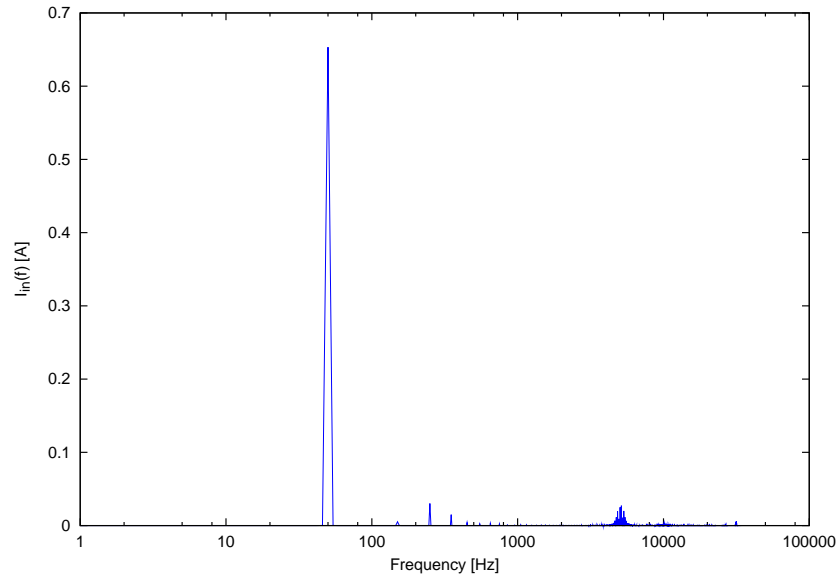

Figure 11: Frequency spectrum of the input current without EMI filter,  $THD = 10\%$ .

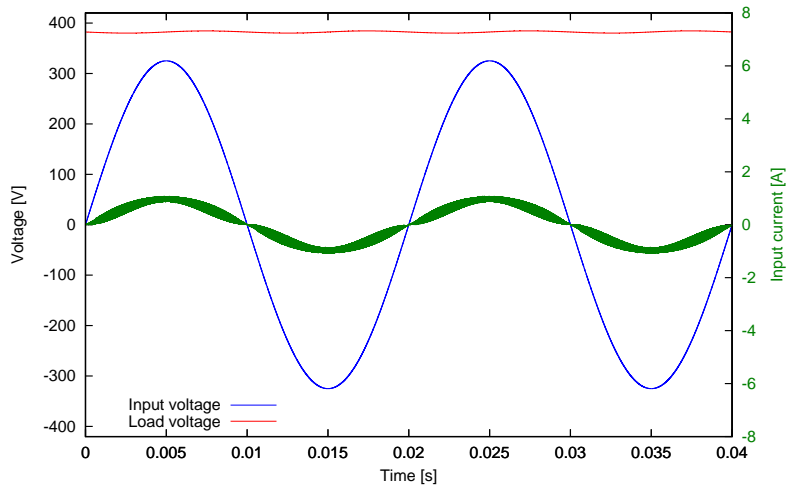

Figure 12: Voltages and currents with active PFC, with EMI filter.

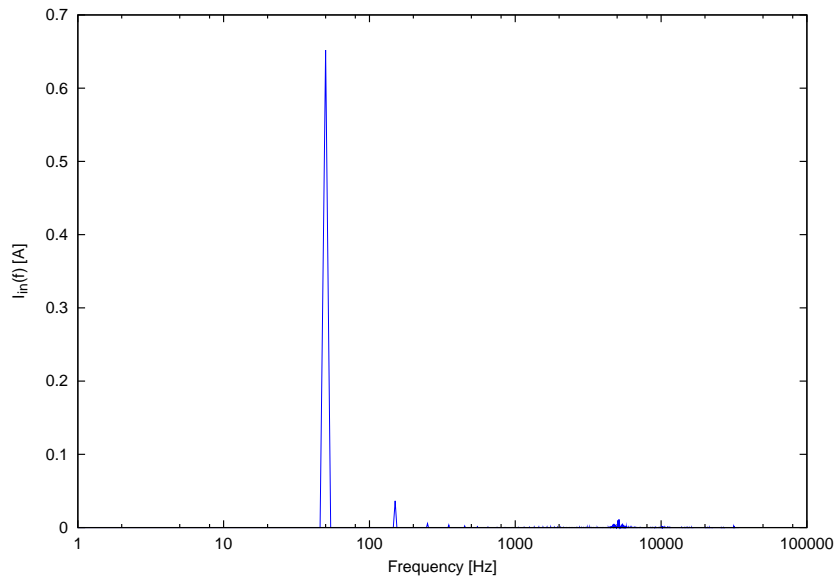

Figure 13: Frequency spectrum of the input current with EMI filter,  $THD = 8\%$ .

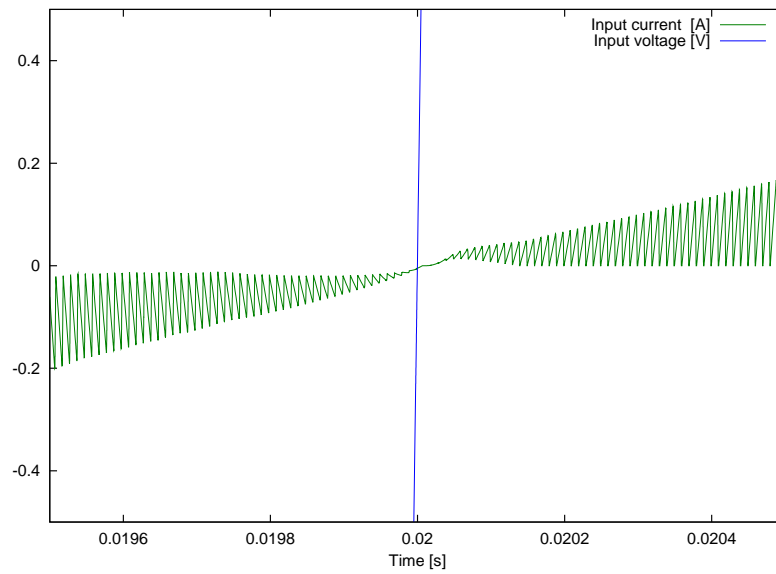

Figure 14: Enlargement of a zero crossing of Figure 12.

## 4 Construction and building

In order to verify the simulations by measurements an active PFC was built. The choice of PFC controller was an International Rectifier 1150, as this seemed the most modern and designer friendly controller on the market. If figure 15 is compared to figure 9 most components are recognised. What is added is mostly circuit protection and measurements components for the converter. The snubber seen on the diode was never implemented, as a SiC-diode was used. These diodes have no reverse recovery, rendering the snubber superfluous [2]. The transistor used is an Infineon CoolMOS Power transistor which is incredibly fast, and have a comparatively small gate charge [3]. This simplifies the gate driver design considerably. A coupled coil is added on the grid connection in order to decrease the common mode currents. It is common to use two serially connected smaller output capacitors instead of one large, due to longer life expectancy of the capacitors [1, page 727]. There is also a wider range of capacitors to choose from when each capacitor only needs to be rated for half the voltage. The drawback from using two capacitors is that if one of the capacitors have a slightly different maximum leakage current from the other, the voltage in the point between them will start to drift. To address this problem resistors is connected in parallel with the capacitors. The resistances is equal and the total resistance is calculated to give a current through the resistors slightly larger than the maximum leakage current of the capacitors. This makes sure that each capacitor only is subjected to half of the total voltage. The rest of the components was chosen in accordance with the design guides for the PFC controller. The inductor was initially designed to give a current ripple of 20% with a rather low switching frequency. Later the frequency was drastically increased and the ripple decreased in the search for better current wave forms. By using a higher switching frequency the switching losses gets higher, but on the other hand it is easier to design output filters to filter out the switching noise. The reason for having double series connected resistors on the output is because ordinary resistors usually are specified with a maximum voltage of 250 V, and the output voltage of the PFC is closer to 400 V. The diode on the top is to charge the output capacitor at start up. It is a large diode that can cope with a large inrush current, but it is slow and have a large forward voltage drop. In the board layout in figure 16 the routing can be studied. All the power traces are placed close to each other, in order to make the current loop as small as possible. All the logic circuitry is located in one low-voltage area of the board. There is also a ground plane under the PFC controller, but that is not visible in the figure. The input voltage range of this design is 85 V – 230 V, and that basically comes for free with an active PFC. The

cost of the design is more or less the same, it is only some minor component values that change.



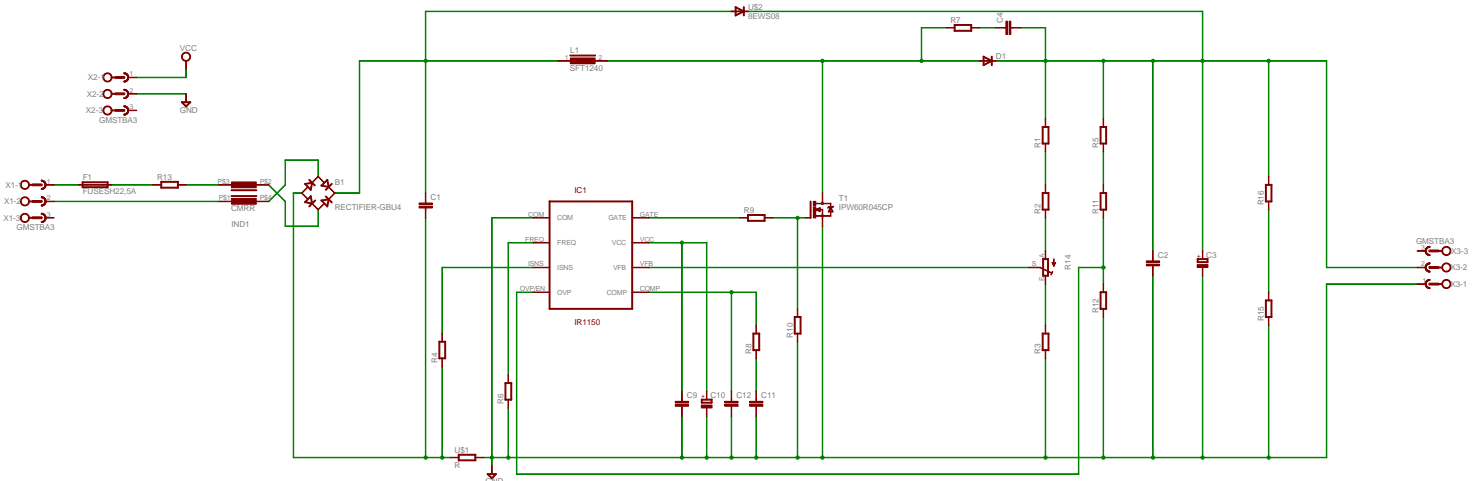

Figure 15: Schematic of the PFC.

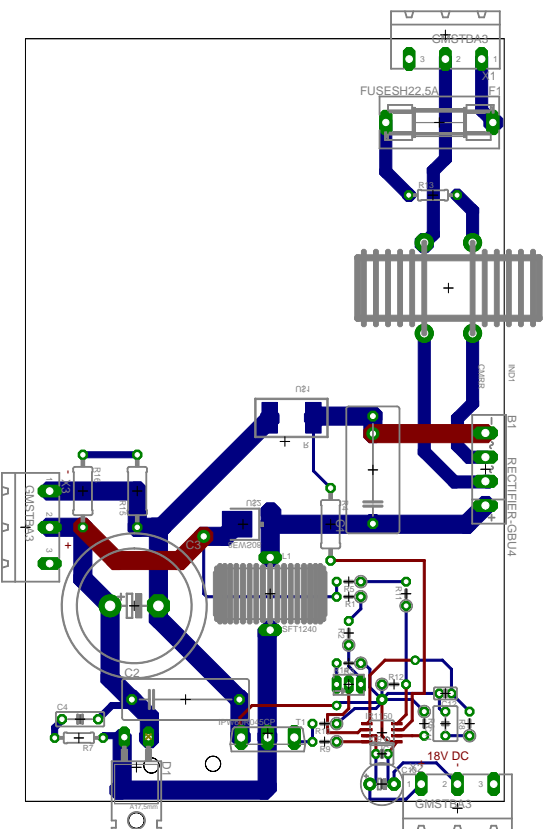

Figure 16: Board layout of the PFC.



Figure 17: The assembled PFC.

## 5 Measurements

Measurements were made using a digital oscilloscope and LEM modules [1, page 727].

### 5.1 Without PFC

For comparison a rectifier without a PFC was built. The current wave forms (figure 18) and FFTs (figure 19) looks very similar to those of the simulated circuit (figure 4 and 5).

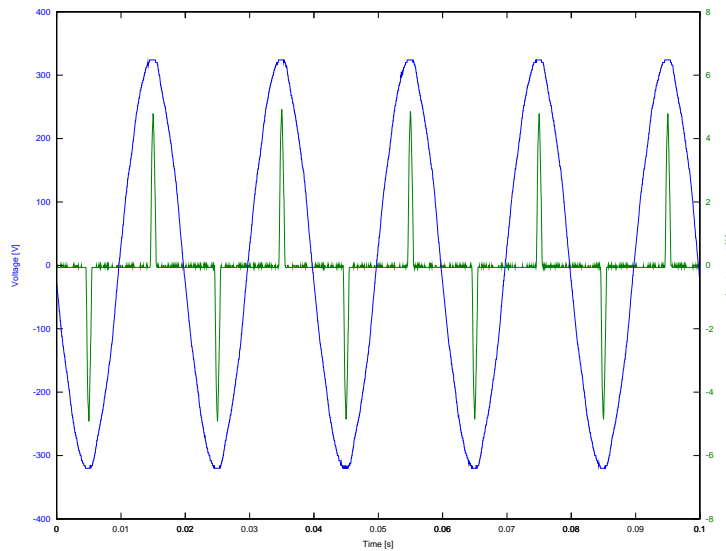

Figure 18: The measured current and voltage to the circuit without PFC.

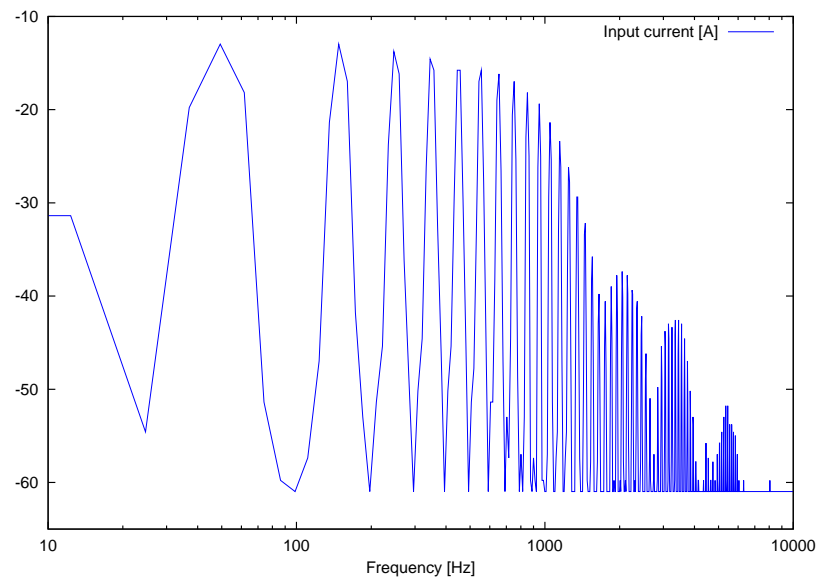

Figure 19: FFT of the measured input current to the circuit without PFC,  $THD = 260\%$ .

## 5.2 Active PFC

At first the active PFC produced really bad waveforms, and a lot of modifications were done to improve the design. The switching frequency was radically increased, the boost inductance was increased as well as decreased, a snubber for the diode was tested but nothing really worked. After some thought about possible reasons for the problem a low pass filter was added (figure 20) on the current sense input to the controller. This is mentioned in the application note[4] for the controller, but was not implemented in the reference design. It is now updated, and the new design includes the capacitor [5]. After this the waveforms were significantly improved, but there is still room for improvement. The voltage regulation works better, with a designed input range of 85 V to 230 V. During the measurements a maximum power of about 250 W were transmitted, to provide some margin to the design goal of 300 W.

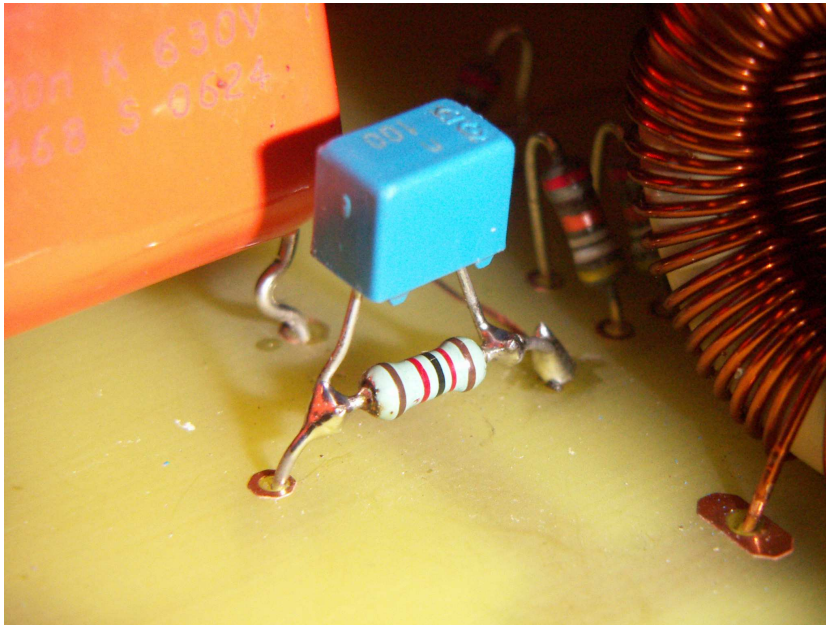

Figure 20: The modifications to the PFC.

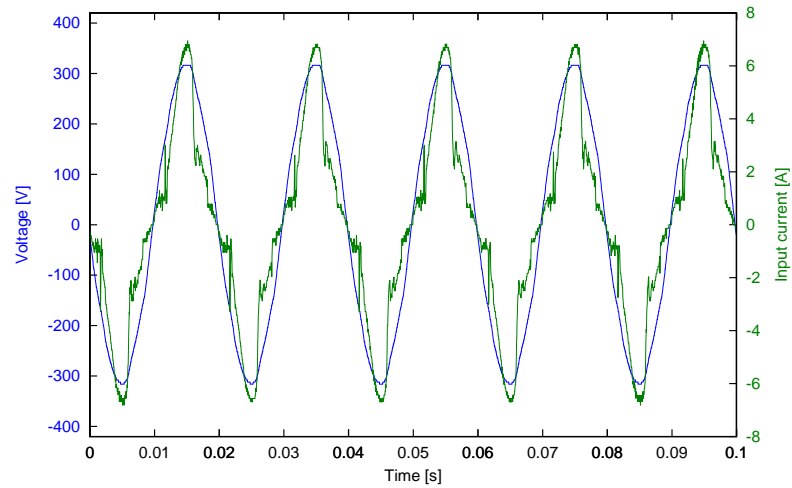

Figure 21: The measured input current to the circuit with active PFC.

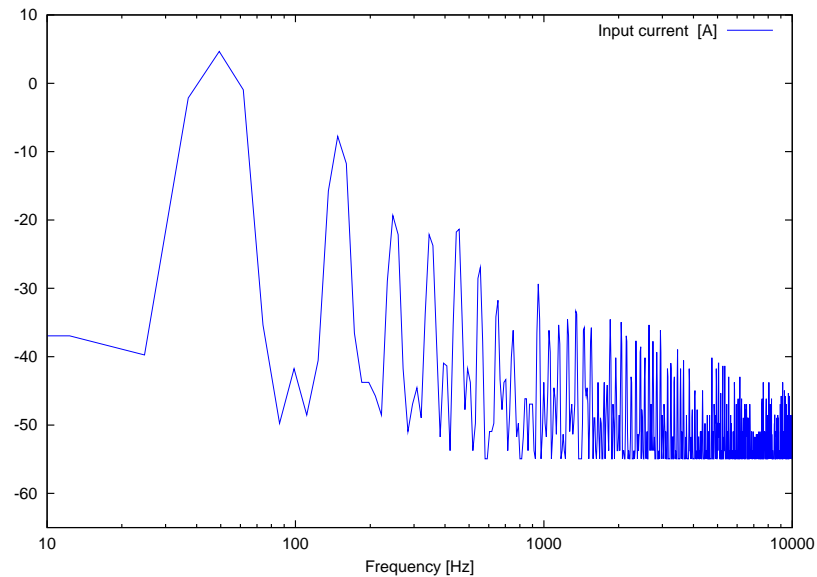

Figure 22: FFT of the measured input current to the circuit with active PFC,  $THD = 100\%$ .

## 6 Evaluation of the different topologies

The active PFC have several advantages over a passive PFC. First and foremost it produces a significantly better current waveform, which yields a higher power factor. It is also considerably lighter, because of the smaller coil needed. Since it incorporates a boost converter it has the added advantage of being able to handle a wide range of input voltages. The boost converter also charges the bulk capacitance to a higher voltage, which gives a longer hold up-time and is beneficial for non linear loads. The passive PFC on the other hand is much easier to design, and has, for small power levels, a lower cost for the materials needed. Since the design is simpler with fewer and simpler components the MTBF can be expected to be longer for a passive PFC.





## 7 Conclusions and discussion

In this study I have looked further into the qualities of different PFC topologies and how they affect the power grid. I have come to the conclusion that the active PFC is superior in almost every respect. The added complexity of the design shouldn't be of any concern for a company dealing with switching power supplies and the gained benefits is enough to leverage the drawbacks. I have also learnt about the complexity of designing switched mode power supplies. My measured values for the circuit without PFC was very similar to those of the simulated circuit, but the wave forms for the active PFC still had room for improvements.

With the new Eco-design regulations[7] that is coming into force in the European Union even the smallest wall mounted battery chargers will need to become more efficient. Basically all external power supplies will have to use switching converters instead of transformers to be able to fulfil the requirements [8, page 19]. Today users of portable equipment are often putting pressure on the manufacturers to provide power supplies that is small and lightweight, and that is also a factor to take into account. Small, lightweight and efficient means that switching converters with active PFCs are called for.

Possible ways forward from here could be to analyse the effects of different PCB trace routing, to replace the dedicated PFC controller with a micro processor to evaluate different control algorithms, or to compare different integrated PFC controllers to each other.



## 8 Bibliography

- [1] Mohan Ned, Undeland Tore M., and Robbins William P. 1995. *Power Electronics: Converters, Applications, and Design*, New York: John Wiley & Sons, Inc.
- [2] [http://www.infineon.com/dgdl/SDT12S60\\_Rev.2.2.pdf?folderId=db3a304412b407950112b408e8c90004&fileId=db3a304412b407950112b439db0f6efa](http://www.infineon.com/dgdl/SDT12S60_Rev.2.2.pdf?folderId=db3a304412b407950112b408e8c90004&fileId=db3a304412b407950112b439db0f6efa), 2007-11-29  
*Silicon Carbide Schottky Diode.*
- [3] [http://www.infineon.com/dgdl/IPW60R045CP\\_rev2.0.pdf?folderId=db3a304412b407950112b408e8c90004&fileId=db3a304412b407950112b42d8e55489b](http://www.infineon.com/dgdl/IPW60R045CP_rev2.0.pdf?folderId=db3a304412b407950112b408e8c90004&fileId=db3a304412b407950112b42d8e55489b), 2007-11-29  
*CoolMOS Power Transistor.*
- [4] [www.irf.com/technical-info/appnotes/an-1077.pdf](http://www.irf.com/technical-info/appnotes/an-1077.pdf), 2007-11-29  
*PFC Converter Design with IR1150 One Cycle Control IC.*
- [5] <http://www.irf.com/technical-info/refdesigns/irac1150-300w.pdf>, 2008-05-25  
*IRAC1150-300W Demo Board User's Guide Rev. 3.0.*
- [6] <http://www.irf.com/technical-info/refdesigns/irac1150-d2.pdf>, 2008-05-25  
*CAPACITORS FOR RFI SUPPRESSION OF THE AC LINE: BASIC FACTS.*
- [7] <http://www.energimyndigheten.se/Global/Filer%20RoT%20-%20F%C3%B6retag/ecee.pdf>, 2008-12-11  
*The Eco-design Directive for Energy Using Products (2005/32/EC).*
- [8] [http://ec.europa.eu/energy/demand/legislation/doc/regulatory\\_committee/2008\\_10\\_17\\_noload\\_condition\\_electric\\_power\\_consumption\\_en.pdf](http://ec.europa.eu/energy/demand/legislation/doc/regulatory_committee/2008_10_17_noload_condition_electric_power_consumption_en.pdf), 2008-12-11  
*... implementing Directive 2005/32/EC of the European Parliament and of the Council with regard to ecodesign requirements for no-load condition electric power consumption and average efficiency of external power supplies.*