

CHALMERS

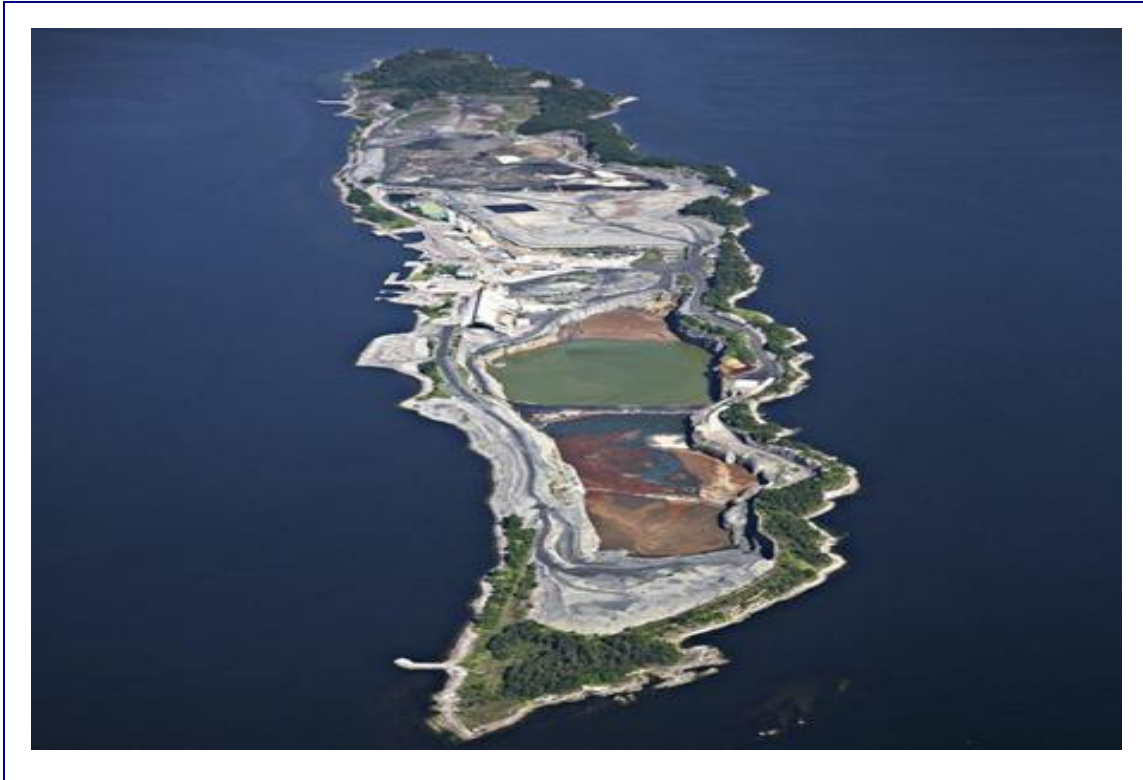

Salt Recovery from Waste to Energy Incineration Fly Ash

A process based on evaporation of brine

Master's Thesis within the Sustainable Energy Systems programme

GUSTAV STENBERG

Department of Civil and Environmental Engineering

Division of Water Environment Technology

CHALMERS UNIVERSITY OF TECHNOLOGY

Master's Thesis BOMX02-16-19

Gothenburg, Sweden 2016

MASTER'S THESIS BOMX02-16-19

Salt Recovery from Waste to Energy Incineration Fly Ash

A process based on evaporation of brine

Master's Thesis within the Sustainable Energy Systems programme

GUSTAV STENBERG

SUPERVISORS

Karin Karlfeldt Fedje

Jale Adawi

Morten Breinholt Jensen

EXAMINER

Ann-Margret Hvitt Strömvall

Department Civil and Environmental Engineering

Division of Water Environment Technology

CHALMERS UNIVERSITY OF TECHNOLOGY

Gothenburg, Sweden 2016

Salt Recovery from Waste to Energy Incineration Fly Ash
A process based on evaporation of brine
Master's Thesis within the Sustainable Energy Systems programme
GUSTAV STENBERG

© GUSTAV STENBERG, 2016

Examensarbete BOMX02-16-19/Institutionen för bygg- och miljöteknik,
Chalmers Tekniska Högskola 2016

Department of Civil and Environmental Engineering
Division of Water Environment Technology
Chalmers University of Technology
SE-412 96 Gothenburg
Sweden
Telephone: + 46 (0)31-772 1000

Cover:
Flight view of Langøya and NOAH AS process (NOAH, 2016).

Chalmers Reproservice
Gothenburg, Sweden 2016

Salt Recovery from Waste to Energy Incineration Fly Ash
A process based on evaporation of brine
Master's Thesis in the Sustainable Energy Systems programme
GUSTAV STENBERG
Department of Civil and Environmental Engineering
Division of Water Environment Technology
Chalmers University of Technology

ABSTRACT

Incineration is a common way to handle municipal solid waste. The remaining residues after the incineration can be divided into two groups, bottom ash and fly ash. The fly ash contains toxic substances such as metal compounds and chlorides and is therefore usually classified as hazardous waste. An industrial company located in Norway is handling fly ash in order to minimise the amount of leached toxic substances. In their process, fly ash is used to neutralize sulfuric acid and thereby immobilize the toxic substances. The chlorides that are not immobilized through the process are leached from the fly ash and diverted to the Oslo Fjord.

In this study, it is investigated whether it is possible to extract salts from fly ash in the industrial process. Ash samples have been extracted from three different positions in the process and from these samples salt solutions were generated. The salts have been dried and crystallised by evaporating the water in the brine. These salts have then been analysed and compared with the regulatory framework for road salt in Scandinavia. The results differ from the three different samples, but for one sample with fly ash mixed with sulfuric acid the results are good and the concentrations of toxic metals are within the limits for road salt in Scandinavia. However, the extracted salt from the industrial process is a mixture of different salts, mainly CaCl_2 , NaCl and KCl . The salts spread on the roads today are mainly NaCl but also CaCl_2 , MgCl_2 are used, however usually not as mixtures.

To get a working process on a large scale, energy is required to evaporate the water in the brine. Therefore it is advantageously to place the salt extraction process close to other industrial activities, which producing waste heat. Different concepts of multiple effect evaporators have been studied with the purpose to investigate how much crystallised salt that can be produced. The evaporator concepts have been designed for two different temperatures on the waste heat. The evaporator using waste heat at the higher temperature (380°C) is more efficient and can produce around 69 000 tonnes of crystallised salt annually. This corresponds to 18 % of the total consumption of road salt in Scandinavia. It is expected that around 100 000 tonnes of salt dissolved in water can be precipitated from the industrial company in Norway, which means that 69 % of this can be evaporated. When trading the salt it may be an advantage to separate the salts from each other. There are technologies for separating but this has not been investigated in this study. The project has great potential and to utilize raw materials throughout the whole production chain is completely in time when raw material shortage is a growing problem in society.

Key words: MSW, fly ash, multiple effect evaporation, road salt, NaCl , CaCl_2 , KCl

Saltåtervinning från flygaska genererad vid avfallsförbränning
En process baserad på indunstning av saltlösning
Examensarbete inom masterprogrammet Hållbara Energisystem
GUSTAV STENBERG
Institutionen för Bygg- och Miljöteknik
Avdelningen för Vatten Miljö Teknik
Chalmers Tekniska Högskola

SAMMANFATTNING

Avfallsförbränning är en vanlig metod för avfallshantering. Slutprodukten från avfallsförbränningen kan delas upp i två delar, bottenaska och flygaska. Flygaskan innehåller en rad olika giftiga ämnen så som metaller och klorider och klassas således som farligt avfall. Ett industriföretag i Norge hanterar flygaska med syfte att minimera urlakning av giftiga substanser. I deras process används flygaska för att stabilisera svavelsyra genom en process som immobiliserar giftiga substanser. Kloriderna som inte immobiliseras i denna process urlakas och leds ut i Oslofjorden.

I den här studien har det undersökts huruvida det är möjligt att utvinna salter ur flygaska från den industriella processen. Askprover har tagits ut ur tre olika punkter i processen. Ur dessa tre punkter har saltlösningar genererats. Vattnet ur dessa saltlösningar har avlägsnats genom indunstning under upphettning. Dessa salter har sedan analyserats och resultatet har jämförts med de krav som ställs på vägsalt idag. Resultaten är spridda för de tre olika provpunkterna men för aska som är blandat med svavelsyra är resultaten bra och mängden giftiga substanser ligger med marginal under de krav som ställs på vägsalt i Skandinavien idag. Salterna utvunna från processen innehåller en rad olika salter, då främst CaCl_2 , NaCl och KCl . Det salt som sprids på vägar idag är främst NaCl men även MgCl_2 och CaCl_2 används men då vanligtvis inte som en mix.

För att få en fungerande process i större skala krävs energi för att indunsta denna saltlösning. Därför är det fördelaktigt att placera denna saltutvinningsprocess nära en annan industriell verksamhet som alstrar spillvärme. Två olika multieffektindunstare har designats med syfte att undersöka hur stora mängder torrt salt som kan produceras. Indunstarna har designats utifrån två olika rökgastemperaturer. Indunstaren som använder spillvärme vid den högre temperaturen (380°C) är mest effektiv och kan producera 69 000 ton torrt salt per år. Detta motsvarar 18 % av den årliga konsumtionen av vägsalt i Skandinavien. Cirka 100 000 ton salt löst i vatten förväntas kunna utvinnas ifrån industrin i Norge vilket betyder att 69 % kan indunstas till salt i kristallform. Vid försäljning av salterna kan det finnas en fördel att separera de olika salterna från varandra. Det finns tekniker för separering men detta har inte undersökts i denna studie. Projektet har stor potential och att utnyttja råvaror genom hela produktionskedjan ligger helt i tiden då råvarubristen blir ett allt större problem i samhället.

Nyckelord: Avfallsförbränning, flygaska, multi-effekt förångare, vägsalt, NaCl , CaCl_2 , KCl

Contents

ABSTRACT	I
SAMMANFATTNING	II
CONTENTS	III
PREFACE	V
NOTATIONS	VI
1 INTRODUCTION	1
1.1 Background	1
1.2 Aim and objectives	3
1.3 Limitations of scope	3
2 LITERATURE STUDY	4
2.1 General facts about road salt	4
2.2 General about MSWI and the produced fly ash	7
2.3 General about NOAH AS and their process today	11
2.4 Crystallisation technologies	12
3 METHOD	15
3.1 Regulations for road salt in Scandinavia	15
3.2 Extraction of salt from the process on Langøya	15
3.3 Brine evaporation	17
4 REGULATIONS FOR ROAD SALT IN SCANDINAVIA	21
4.1 European standardisation	21
4.1.1 Sodium chloride	22
4.1.2 Magnesium chloride	23
4.1.3 Calcium chloride	24
4.1.4 Salt blends	25
4.2 Requirements for road salt in Norway	25
4.3 Requirements for road salt in Sweden	26
4.4 Requirements for road salt in Denmark	27
5 RESULTS AND DISCUSSION	29
5.1 Salt composition	29
5.2 Evaporation and drying process	34
6 CONCLUSIONS	40

7	FURTHER CHALLENGES	41
8	LIST OF LITERATURE	43
9	APPENDIX A – FLOW SHEET	46
10	APPENDIX B – RAW DATA	47
11	APPENDIX C – HEAT BALANCES FOR LOW TEMPERATURE PROCESS	48
12	APPENDIX D – HEAT BALANCES FOR HIGH TEMPERATURE PROCESS	51

Preface

This master thesis was performed during the spring term of 2016 together with the Norwegian company NOAH AS, within the Sustainable Energy System programme at Chalmers University of Technology. At first, I would like to say many thanks to NOAH AS and especially Jale Adawi and Morten Breinholt Jensen, who have helped and supported me through this thesis. I am also thankful for the help from my supervisor, Karin Karlfeldt Fedje, Division of Water Environment Technology at Chalmers University of Technology. She has support me throughout the whole project with technical issues as well as practical tips for the writing of the report. I also want to say thank you to my examiner Ann-Margret Hvitt Strömvall, Division of Water Environment Technology at Chalmers University of Technology, for her help during this thesis.

Notations

BFB	Bubbling fluidised bed
BFBC	Bubbling fluidised bed combustor
CaCl ₂	Calcium chloride
CEN	European Committee for Standardisation
CFB	Circulated fluidised bed
CFBC	Circulated fluidised bed combustor
DOC	Dissolved organic carbons
FBC	Fluidised bed combustion
HRSG	Heat recovery steam generator
ICP	Inductively coupled plasma
KCl	Potassium chloride
LS-value	Liquid to solid value
MBC	Mass burn combustor
MgCl ₂	Magnesium chloride
MSW	Municipal solid waste
MSWI	Municipal solid waste incineration
NaCl	Sodium chloride
NO _x	Nitrogen oxides
SO _x	Sulphate oxides
THC	Total hydrocarbons
TOC	Total organic carbon

1 Introduction

1.1 Background

A growing problem in society is the increased production of waste from households and industry. In 2013 the total amount of waste generated from households in Sweden was around 4 450 000. This equals to 461 kg/person annually. Of all generated waste from households, 33 % was recycled, 50 % was used for energy production, 15 % was used for biologic recovering and the remaining part was used for landfill. (Westin, 2013).

A common way to handle municipal solid waste (MSW) is to use it for production of energy. The residues from incineration can be divided into two groups, fly ash and bottom ash. Bottom ash is the ash that falls down through the bottom of the combustion furnace. After total combustion the metal parts are removed from the bottom ash and the remaining ash may be stored and used as construction material. Fly ash is usually classified as hazardous waste. The reason is that the amount of heavy metals, mainly zinc and lead, is above the limits. The limits are 2 500 mg/kg for both lead and zinc. Also the high pH value and the high level of chlorides make the fly ash classified as hazardous waste (Marit Læg Reid , 2014).

The Norwegian company NOAH AS is today handling around 270 000 tonnes of fly ash from industrial and municipal solid waste incineration annually. Most of the fly ash is derived from Scandinavia. Today all of this fly ash handling takes place on the island Langøya, in the township of Re in Norway. The 270 000 tonnes of fly ash containing lime has alkaline properties and is used to neutralize sulfuric acid from the Norwegian company Kronos Titan, which is producing titanium dioxide. Around 200 000 ton of sulfuric acid is annually neutralized by mixing it with the fly ash. When the fly ash and sulfuric acid are mixed, solid gypsum is created. This gypsum is also binds heavy metals and prevents them from being leached out into the Oslo Fjord. This remaining gypsum is recovered on Langøya. However, the remaining slurry is containing salts leached from the fly ash. This salt slurry, called brine, is pumped through a water treatment plant including a sand- and carbon filter, with the aim to remove remaining particles and dissolved organic carbons (DOC). The brine is today diverted into the Oslo Fjord. Continuous laboratory samples are made by NOAH AS to ensure the right pH value and particle content. Every year 600 000 – 800 000 m³ of treated water is diverted into the Oslo Fjord (Breinholt Jensen, 2016).

The facility on the island Langøya is expected to be fully utilized within a few years and NOAH AS is looking for a new place to recover sulfuric acid with fly ash. One possible proposal is to establish a new facility in Brevik close to Oslo. NOAH AS wants to increase the level of recycled substances from their process. For the new facility the possibility to recover the salts in the water slurry instead of wasting it into the Oslo Fjord is of great interest. If it is possible to recover the salts, it can eventually be used as road salt. This could be both economically profitable and have a positive influence on the environment.

Norcem AS is a cement factory in Brevik, which produces cement, but also waste heat that could eventually be used to evaporate the water from the brine in NOAH AS's further facility. If it is possible to evaporate all water and produce salt in crystallised form the transportation costs will be lower.

Road salt is used in the whole Scandinavia on the roads to remove snow and ice (Wikström, 2016). It can also be used preventively before slippery roads occur. Salt is today the most common alternative to avoid ice and snow on the roads. Sand can only replace salt on low traffic roads. There are other substances such as calcium magnesium acetate, that can be used with same results as salt but the cost is too high today (Trafikverket, 2015). With NaCl, that is the most common de-icing agent, it is possible to melt snow down to -18°C but in most cases the recommendation in Scandinavia is to use salts on roads down to -6°C . Colder than this requires too much salts (Trafikverket, 2015). By this reason road salt is unusual in the northern part of Scandinavian (Wikström, 2016).

The salt consumption is varying from year to year depending on the climate. The total consumption of road salt in Scandinavia the winter 2013/14 was 379 000 tonnes. The annual consumption of road salt for each country is presented in Figure 1 (Freddy Knudsen, 2014).

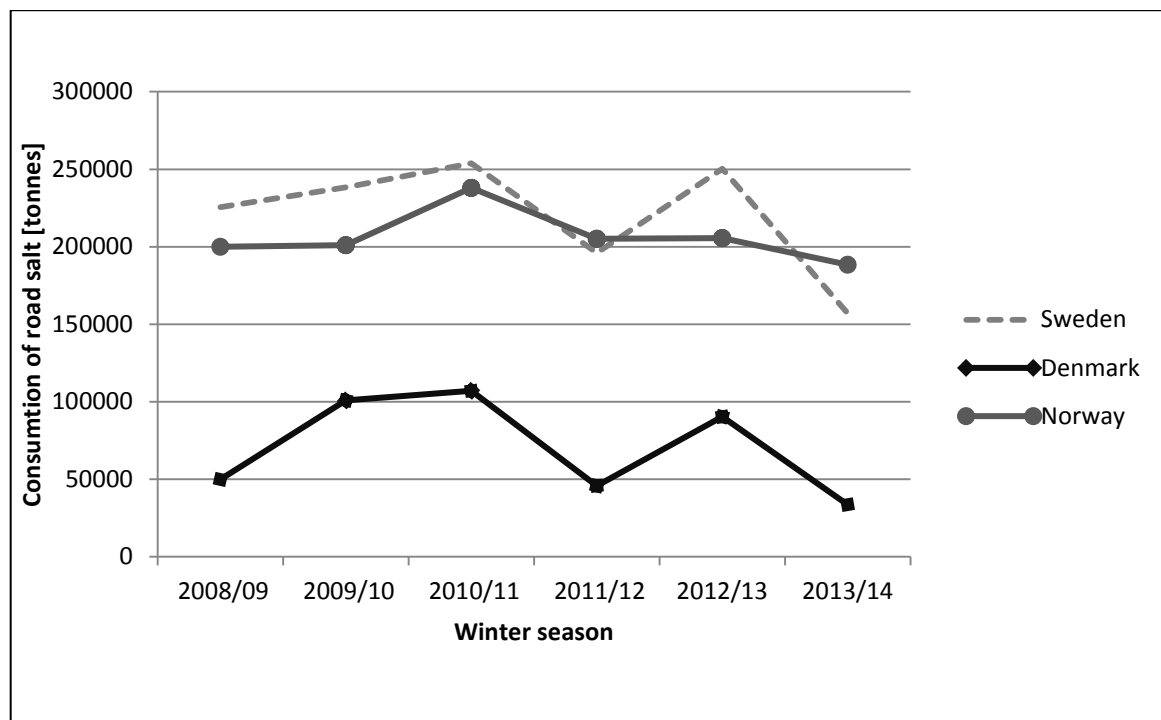

Figure 1 Annually consumption of road salt in Scandinavia

Salt is produced by evaporation of sea water, by salt mining, as a by-product or by a process called vacuum salt. Sea salt is mainly produced in warmer countries where the water is evaporated by the sun in pounds. Vacuum salt is the name of a process where water is injected into salt deposits. This process is used when the deposit is deep in the ground, up to three thousand meters deep, and ordinary salt mining cannot be used. Water is pumped into drill holes, the crystallised salt is dissolved and resulting brine can then be recovered. To produce salt from fly ash is an example of salt produced as by-product. The road salt is today mainly imported from Germany. Most of the road salt is transported dry to minimize the transportation costs. Salt used as a de-icing agent on roads is mainly NaCl originating from salt mining but a small part is also from evaporated salt water and vacuum salt (Eide, 2016).

1.2 Aim and objectives

The aim of this study is to investigate the possibility to recover salts from fly ash. This study was performed for fly ash handled at NOAH AS's process on Langøya in Norway. The possibility to recover salts from the ash can have an environmental- and economic profit and is therefore of great interest. More detailed information about the composition of the brines will be presented and compared with the regulations for road salt in Scandinavia. Methods to evaporate the water from the brine are also of interest.

Scientific questions:

- What is the regulatory framework for road salts used in Scandinavia today?
- What is the composition of different salts in the extracted brine from the process on Langøya?
- How high is the total concentration of salts in the brine?
- What kind of different toxic substances such as toxic metals are present in the salt and in what quantities?
- Is it possible to use the waste energy from an industrial process to crystallise the salts in the brine? How much energy is required?
- Does the salt extracted from Langøya reach the regulatory framework that exists in Scandinavia?

1.3 Limitations of scope

- Methods to separate different salts from each other will be briefly discussed but not analysed in depth.
- Methods for removal of eventually toxic substances from the salt will not be discussed.
- The regulatory framework for road salt usage will only be investigated for Scandinavia.
- Economic calculations for the salt production in large scale will not be investigated.

2 Literature study

2.1 General facts about road salt

There are many ways to maintain the roads when winter conditions occur. Today salt is the most widely used chemical substance for ice control on the road ways. NaCl is the most common but MgCl₂ and CaCl₂ are also used (CEN, 2016).

NaCl is the most used chemical substance for de-icing. NaCl used on roadways today can be divided into three groups depending on the origin.

- Rock salt is obtained from underground deposits by traditional mechanical mining. The salt is then ground to suitable fraction (Demmer, 2014).
- Vacuum salt is also obtained from underground deposits. It is a method where water is pumped through bore holes into underground deposits. The water dissolves the salt crystals so that the resulting brine can be recovered. The deposits used for this method to obtain salt can vary between a few hundred to three thousand meters under the ground. The remaining brine is purified, the water is evaporated with steam and the salt is crystallised. It is interesting to note that all salts in this type of deposits remains from earlier lakes and has already been crystallised once. This has resulted in that CaCl₂ is separated from NaCl (Geertman, 2000).
- Sea salt is produced by using the energy from the sun to evaporate the water. This process is only possible in warm southern countries. Sea water contains different salts, such as NaCl and MgCl₂ and this is separated by utilizing the different metal ions density. Separation by utilizing the different metal ion's density requires much time and is only used when producing sea salt (Demmer, 2014).

The size of the salt particles is of great interest for all salts. As noted above rock salt is ground to the right size but this is not the case for vacuum salt and sea salt. The crystal structure is influenced by many different parameters and the most important parameter is time. A slower evaporation process gives larger crystals. This means that the slow evaporation process for sea salt gives larger crystals than the fast evaporation process for vacuum salt production (Choi, 2005). Overall large crystals are desirable since the risk of clumping is decreased. Too large crystals can always be crushed to the right size. (Eide, 2016)

In complement to NaCl other salts such as MgCl₂ and CaCl₂ are used. KCl is not so commonly used as road salt in Scandinavia today but it would be theoretically possible. KCl is used to produce fertilizer for agriculture. (Eide, 2016)

MgCl₂ is today produced from underground deposits, from sea water, from salt lakes and as a by-product when producing KCl and K₂SO₄. CaCl₂ is mainly produced from calcium carbonate and hydrochloric acid (CEN, 2016). A drawback that has been discussed by using MgCl₂ and CaCl₂, is their negative influence on concrete. Even NaCl degrade concrete and increase the corrosion of the reinforcing bars but not as much as MgCl₂ and CaCl₂ (Gustafsson, et al., 2010). Another drawback with MgCl₂ and CaCl₂ as de-icing agents is their hygroscopic characteristic. It makes it more expensive and advanced to handle due to their ability to attract moisture. On the other hand the hygroscopic characteristic is desirable for dust control on gravel roads.

Therefore $MgCl_2$ and $CaCl_2$ are spread on gravel roads to hold dust down (Vegvesen, 2014).

$MgCl_2$ and $CaCl_2$ are mostly presented with crystallised water. $NaCl$ and KCl are presented as anhydrous salt, which means that no crystallised water is present. $MgCl_2$ used as road salt will normally be presented as hexahydrate, ($MgCl_2 \cdot 6H_2O$). $CaCl_2$ can be found as $CaCl_2$, $CaCl_2 \cdot H_2O$, $CaCl_2 \cdot 2H_2O$ and $CaCl_2 \cdot 6H_2O$ but the most common form used as de-icing agent is $CaCl_2 \cdot 2H_2O$ (Vejdirektoratet, 2006).

Based on the molar masses for the different salts the water content can be calculated, see Figure 2.

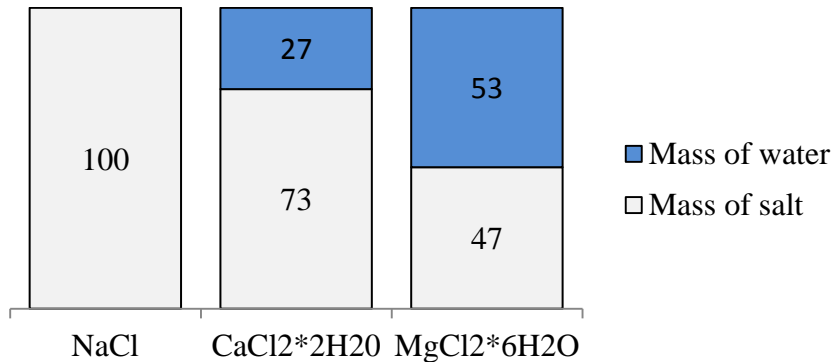

Figure 2 Content of crystallised water in road salt

The price for $MgCl_2 \cdot 6H_2O$ is around 1500 SEK/tonne and around 2000 SEK/tonne for $CaCl_2 \cdot 2H_2O$ and KCl including transport. The lower price for $NaCl$ (600-700 SEK) is probably one of the reasons that $NaCl$ is most common as de-icing agent. Note that this is only estimated prices based on interviews with actors trading with salt.

If a solution is treated as an ideal solution the freezing point can be estimated by the relationship in equation 1. The temperature difference ΔT_f is the temperature decrease for the new freezing point in $^{\circ}C$. Note that this relationship only is an approximation and for precise results more advanced equations are needed (Larson, 2008).

$$\Delta T_f = i \cdot m \cdot K_f \quad [^{\circ}C] \quad (1)$$

where:

i = Van't Hoff factor, the moles of solute particles divided with the moles of solute dissolved,

m = The molality mol_{salt}/kg_{H_2O}

K_f = The molar freezing point depression constant, which is 1.86 for water.

In Figure 3 below a phase diagram for MgCl_2 , CaCl_2 and NaCl is shown. As seen the eutectic point occur when the salt concentration is 21.6 % for MgCl_2 , 23.3 % for NaCl and 30.0 % for CaCl_2 . From the phase diagram the minimum melting temperature for respective salt can be seen. Thereby, it is clear that MgCl_2 and CaCl_2 is a better choice for ice removal when cold temperatures occur.

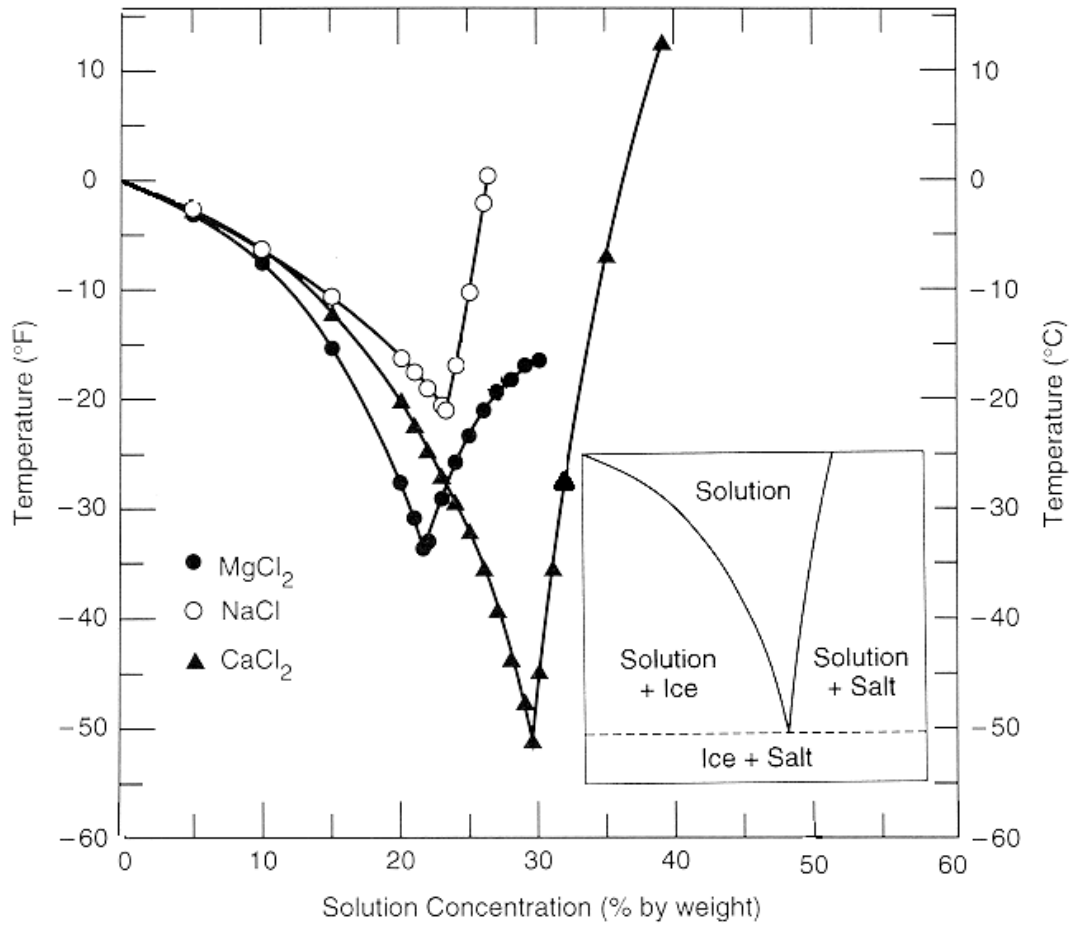

Figure 3 Phase diagram (Anon., 2012)

From the equation 1, the amount of salt needed to melt ice can be estimated. In Figure 4, the result is presented in a plot. As can be seen NaCl is the most efficient, since MgCl_2 and CaCl_2 is presented with crystallised water. However MgCl_2 and CaCl_2 are still the only alternatives for low temperatures.

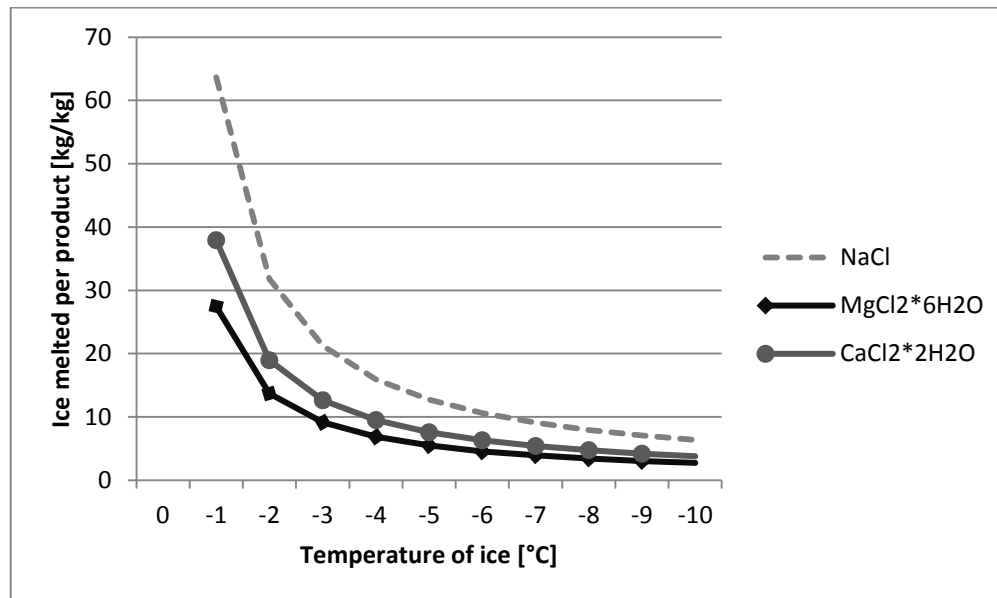

Figure 4 the amount of ice in kg melted per kg salt

2.2 General about MSWI and the produced fly ash

MSW arises from human activity. The waste has to be handled and treated to minimise the impact on the environment and human health. Incineration of MSW fulfils two purposes. Primarily it reduces the amount of waste used for landfill. Incineration of MSW will not completely eliminate the volume of waste but it will be significantly reduced. The reduction is approximately 90 % in volume and 75 % in weight. The energy released by incineration of MSW is also used to produce district heating and electricity (Sassan, 2009).

There are several different technologies for municipal solid waste incineration (MSWI). The most common one is mass burn combustion (MBC) with a moveable grate or in some cases rotary kilns. Incineration of MSW in a fluidised bed combustor (FBC) is also a widespread technology (Peña, 2011).

The MBC with moveable grate is made up by either a horizontal or sloping grate. The grate is moving and transporting the fuel through the furnace, see Figure 5. For a sloping grate the fuel is transported downwards. Primary air is entering under the grate and secondary and tertiary air is entering above the fuel bed to make sure complete burn out (Teir, 2002). The residues after incineration of MSW can be divided into two groups, bottom ash and fly ash. The bottom ash falls through the grate and is then collected. Fly ash is the particles that are light enough to exit the furnace with the flue gas. The fly ash is then collected in the flue gas cleaning system. The temperature in a MBC is around 1 000°C.

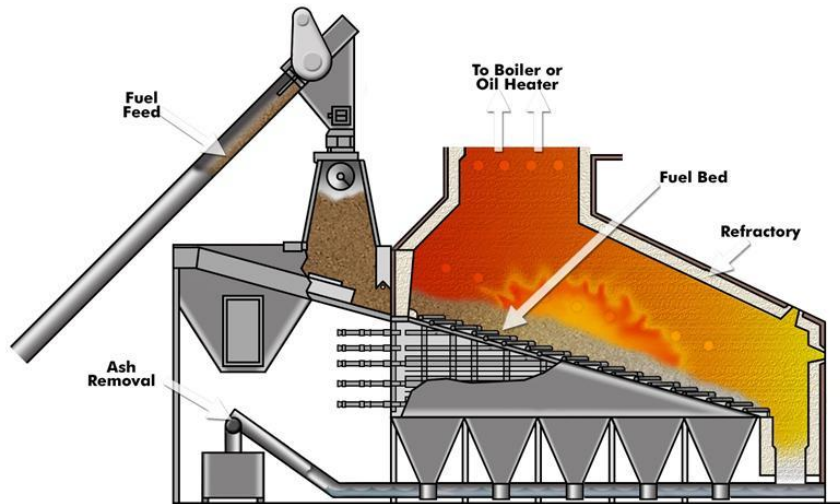

Figure 5 MBC with sloping grate (Anon., 2009)

FBM is a combustion technology where the fuel is suspended in a furnace with a hot bubbling fluidized bed of sand, see Figure 6. The arrangement of air nozzles in the bottom of the furnace creates turbulence that enhances the mixing of the fuel. It is also the primary air that enters at the bottom of the furnace that creates the fluidization of the solid particles. The sand transfers the heat to the water tubes effectively, which enables a low temperature in the furnace, around 850°C. The low temperature will also reduce the formation of NO_x (Karlfeldt Fedje, 2010). Air staging is created by secondary and tertiary air that is entering up streams in the furnace. FBM can be divided into circulated fluidised bed combustors (CFBM) and Bubbling fluidised bed combustors (BFBM). For combustion of MSW, BFBM are almost exclusively used. (Peña, 2011). In a BFBM, the bottom ash is collected in the bottom of the furnace and the fly ash is leaving the furnace with the flue gas on the same way as for an MBC.

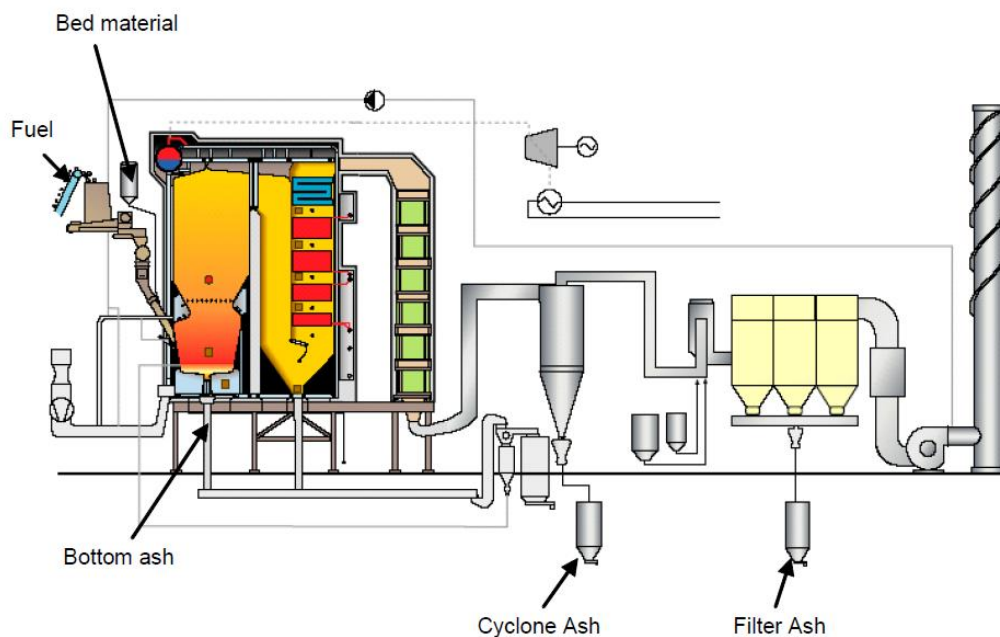

Figure 6 Schematic picture of a BFBC (Metso, 2010)

However bottom ash from both MBC and BFBC consists of mostly non-combustible particles, which are a residual part from household waste. The bottom ash is sent to a reprocessing facility where metals are separated for recovery. The combustible particles are removed and the remaining bottom ash is stored in order to improve its quality. The bottom ash is then suitable as a construction material, for example as filling material for road construction (Cewep, 2009).

MSW is a heterogeneous fuel, which means that the quality of the fuel will vary both over time and between different plants. The fly ash from incineration of MSW is not useable as a construction material due to high level of toxic metals and chlorides. The acceptance for using fly ash from MSWI is low due to the environmental risk for leaching of toxic metals and chlorides. A large part of the fly ash in Scandinavia is therefore sent to Langøya in Norway for further treatment.

As mentioned above the quality of the MSW fuel will vary, which means that also the content in the fly ash will vary. There are also other parameters that affect the content of different substances in the fly ash. A high temperature will evaporate metals with a low boiling temperature point, so that the amount of metals increases in fly ash. This means that the concentration of toxic metals in the fly ash usually is higher for MBC.

However, volatilization of metals also depends on the gas composition. An increased concentration of chlorides such as HCl will increase the volatilization of metals such as Cd, Pb, Cu and Zn. In the same way, an increased concentration of sulphur can decrease the volatilisation of metals. Further the flue gas is cooled down and volatilised metals are condensed into small particles (Wikman, et al., 2003).

The flue gas is passing through a flue gas cleaning system before entering the atmosphere. The particles in the flue gas are in most cases removed in a bag filter or by electrostatic precipitation. Before this filter, CaCO₃, Ca(OH)₂ or sodium hydrogen carbonate (NaHCO₃) can be added to remove SO_x and chlorides (Ronald D. Bell, u.d.).

Equation 2 shows a reaction with slaked lime and hydrogen chloride as reactants. The product after reaction is salt in form of CaCl₂ and water.



Equation 3 shows a reaction in which limestone is used as a neutralizing reagent.

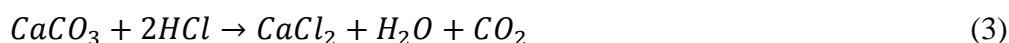

When sodium hydrogen carbonate is used as a neutralising reagent, following reaction occurs, see equation 4 (Ronald D. Bell, u.d.).

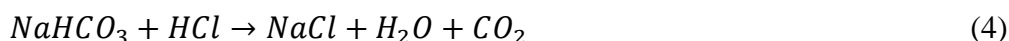

As can be seen the choice of cleaning system affects the production of salts and the amount of produced salt can be regulated by different cleaning systems.

The fly ash is then collected and transported for further treatment. After the bag filter the remaining flue gas sometimes passing a wet scrubber for reduction of chlorides and sulphur. Also, selective catalytic reaction (SCR) or selective non catalytic reaction (SNCR) are used to reduce NO_x.

In Figure 7, a flow sheet of Renova AB's facility in Gothenburg is presented. Renova AB uses MBC. The fuel enters the furnace (2) and the produced energy is then used to produce steam in the steam generator (4). This heat is then used to produce electricity and heat. The flue gas is passing through an electrostatic precipitator (8), where 99 %

of the fly ash is collected. In this process, the fly ash is removed before the flue gas is passing through any other cleaning equipment, which means that the fly ash not is affected by added substances such as limestone. Furthermore the fly ash is cleaned in a wet scrubber (9) and a SNCR (10)

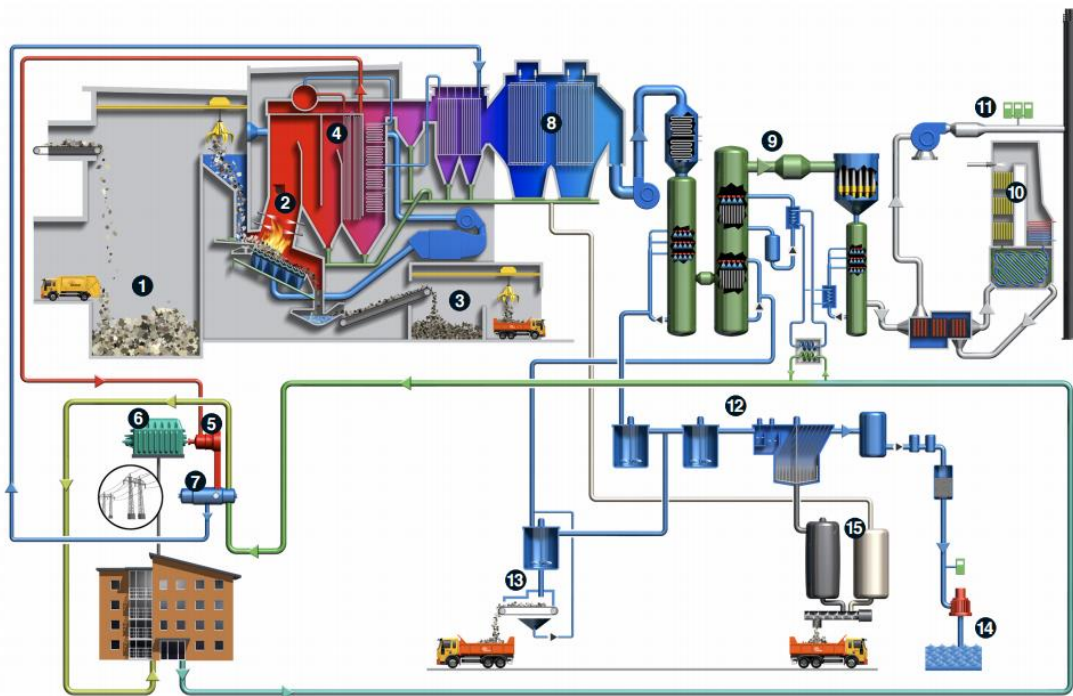

Figure 7 Schematic picture of Renova AB process and their cleaning system (Renova, u.d.).

There are no full-scale plants, which currently extract salts from the fly ash but there is a functional test facility. A company handling fly ash has succeeded to extract salts from fly ash with low concentrations of heavy metals. The fly ash is washed with water and CaCl_2 , KCl , NaCl and ammonium is extracted from the remaining solution. The salts are separated from each other and are then recirculated and reused in the society. For example KCl can be used to produce fertilizer for the agriculture. More details about the technology are not available due to company secrets. (Ragn-Sells, 2016).

A washing process called Halosep has also been developed. In this process, the fly ash is stabilised by mixing it with acid water from the scrubber. The ash particles are then removed and the remaining brine is treated in two steps. In these two steps toxic metals is precipitated by mixing the brine with lye and TMT15. The last mentioned is a 15 % solution of trimercapto-s-triazine trisodium salt. The remaining brine is a blend of mainly CaCl_2 , KCl and NaCl . For more details, see (Rasmussen, 2015)

2.3 General about NOAH AS and their process today

NOAH AS is operating on the island Langøya in Norway in the township Re. Between 1899 and 1985 Langøya was a quarry for extraction of limestone. The total amount of limestone produced was around 45 million tonnes which lead to 9.3 million m³ large crates down to 80 meters under sea level. Since 1985, Langøya is utilized for treatment of hazardous waste, such as fly ash generated from MSWI and sulfuric acid (NOAH, 2016). In Figure 8, a simplified flow sheet for the process on Langøya is presented. For a more detailed flow sheet, see Appendix A – Flow sheet.

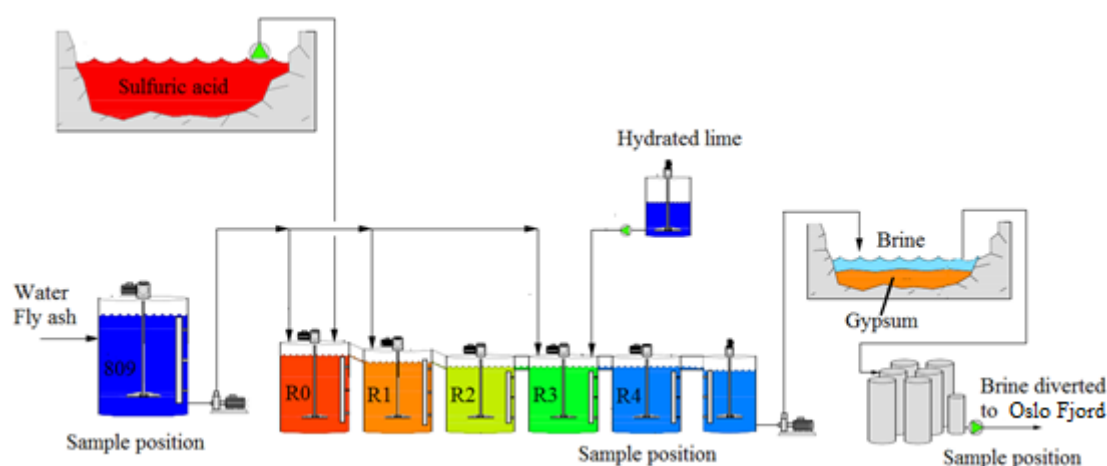
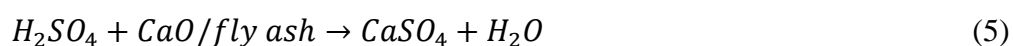

Figure 8 Simplified flow sheet of the process on Langøya

Fly ash is transported from the whole of Scandinavia to Langøya with ships and trucks. The fly ash is unloaded to storage and is then mixed with water in large tanks (809). Salts and some toxic metal compounds are leached from the fly ash. The sulfuric acid transported to Langøya is acidic and needs to be neutralised by the alkaline fly ash solution. The fly ash solution and the sulfuric acid are mixed in vessels R0-R4 until the right pH level is reached in the R4 tank. The reaction between the fly ash and sulfuric acid creates solid gypsum, see equation 5 (Breinholt Jensen, 2015).



Hydrated lime can also be added to reach the right pH level. The remaining gypsum slurry is then pumped to a large crate where the gypsum settles and immobilizing toxic metals and prevent them to be leached. The water containing salt is then recirculated or pumped through a water treatment plant including a carbon- and sand filter to remove particles before it is diverted into the Oslo Fjord. The crates are constantly filled with more gypsum and Langøya will therefore be fully utilized within a few years. The future plan is to build a new facility in Brevik with a similar treatment.

2.4 Crystallisation technologies

The salts extracted from the process on Langøya are solved in brine. To obtain dry salts in crystallised form, the water in the brine has to be removed. Removing water from the brine is a well-known technology that is used for example when producing vacuum salt (GEA, 2012).

To achieve crystallisation, the brine has to be supersaturated, which means that the solution has a concentration above the saturation point. This can be done by cooling, evaporation, chemical reaction and salting out. The most common processes for crystallisation are those using evaporation or cooling. In the evaporation process some of the water in the brine is removed as vapour and the concentration becomes supersaturated. If the soluble curve for the specific salt is steep, supersaturation can be achieved by cooling. In Figure 9, solubility curves as functions of temperatures are plotted. In the right graph the solubility curve is steep and the solution can easily be supersaturated by cooling (GEA, 2012).

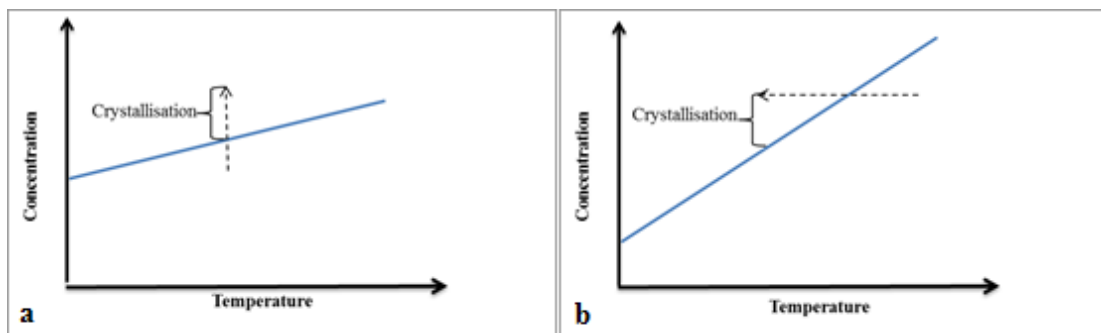

Figure 9 Schematic solubility curves. a) suitable for evaporation and b) suitable for cooling

Different salts have different solubility. In Figure 10 solubility for different salts are presented. As can be seen the curves for CaCl_2 and KCl are steep, which means that supersaturation easily can be reached by cooling. Crystallisation by cooling is therefore usually chosen when the brine is strongly dependent on the temperature (Allan, 2015).

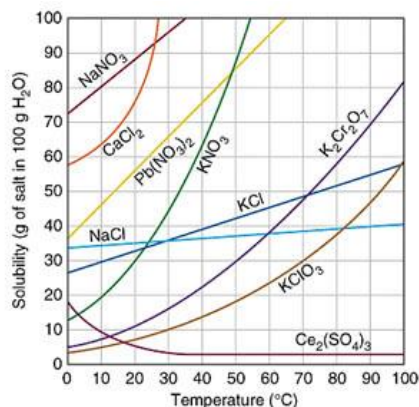

Figure 10 Solubility curves for different salts (Allan, 2015)

Evaporators are used in process industry to concentrate solutions. A dilute solution contains a large amount of water and needs more heat to be concentrated and is therefore more expensive.

In warm countries solar evaporation of sea salt is a common way to crystallise NaCl but in Scandinavian the climate is too cold for this method. Instead, an external heat source such as steam produced from waste heat is used to evaporate the brine. There are many different evaporation techniques available such as spray evaporation, falling film evaporation, forced circulation (FC), turbulence crystalliser (DTB) and OSLO crystalliser. For crystallisation of salts, the three last mentioned are the most common methods. The principle in those three are similar but the mixing of energy and retention time differs. This difference will affect the size of the crystals. The crystal size is 0.2-0.6 mm for a FC crystalliser, 0.5-1.5 mm for a DTB crystalliser and above 1.5 mm for an OSLO crystalliser (GEA, 2012). The crystal size is of great interest for road salt.

When a single evaporator is used for concentration the process is called single effect evaporator. When a number of sequential effects are used in a sequential serial, it is called multiple effect evaporators. Single effect evaporators are simple but the efficiency is low, while the multiple has a higher efficiency. More details can be studied in (Nayak, 2012). This means that the variable costs are lower for a multiple effect evaporator, while the fixed cost during installation is lower for the single effect evaporator. Figure 11 shows a schematic flow sheet of a forward feed multiple effect evaporator system with three effects. Waste heat in the form of steam with temperature $T_{\text{steam, in}}$ is used as heat source. This heat is entering the heat exchanger in effect 1 and is used to heat the brine, which provides the heat of vaporization. Satisfactory static head is provided to the tubes in the heat exchangers to prevent the brine to start boiling in the heat exchanger. The concentration of salt in the brine is increased in effect 1 and is further fed to effect 2. The steam evaporated in effect 1 is used as heat source in effect 2. To make this process possible, the temperature $T_{\text{steam, in}} > T_1 > T_2 > T_3$, which also means that $P_{\text{steam, in}} > P_1 > P_2 > P_3$. In an ideal process without any losses the same amount of heat is transferred in all the effects. It is common with multiple effect evaporators with up to seven effects. In a single effect evaporator the evaporated water from the brine goes to waste but in a multiple effect evaporator the heat of vaporization is used in many steps before going to waste, which increases the efficiency.

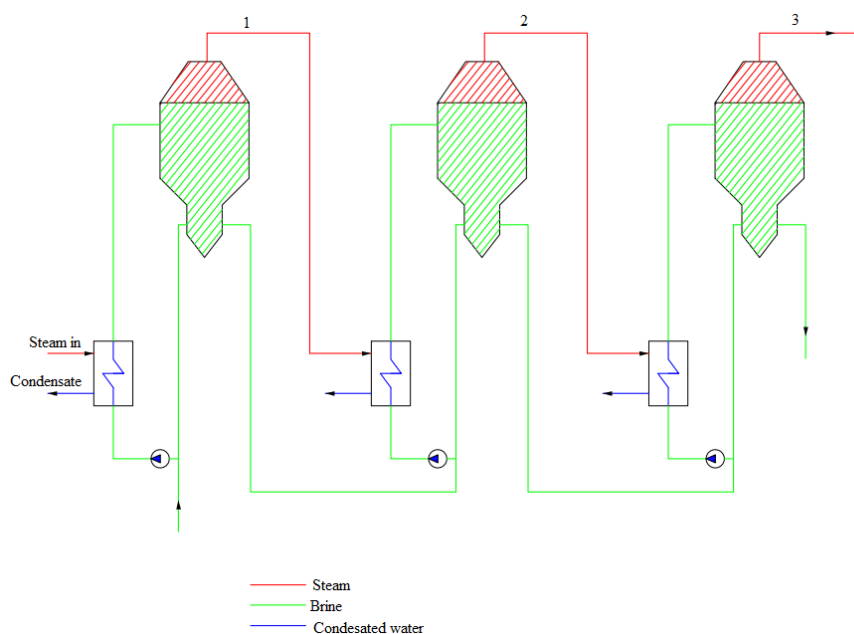

Figure 11 Schematic flow sheet of a forward fed triple effect evaporator

Backward feed multiple effect evaporator is also a common method. The principle is the same as in Figure 11 but the brine is fed in the opposite direction. In this case a pump is needed between all the effects to increase the pressure in each stage. In a backward feed multiple effect evaporation process the temperature of the final product is higher, which can be desirable. (Nayak, 2012).

In a multiple effect evaporator different salts can be separated from each other. The technology is based on the fact that different salts are precipitated at various concentrations. By extracting salts between each evaporator the salts can be separated. The technology is easy to carry out when separating NaCl from CaCl₂ due to the big difference in solubility. It is more difficult to separate NaCl from KCl since their solubilities are similar (Hailong, et al., 2014).

3 Method

In this chapter the aim is to present tools and methods that were used to answer the questions mentioned in purpose, chapter 1.2

3.1 Regulations for road salt in Scandinavia

This part of the investigation is a kind of research task. Information about road salt was collected and analysed for the whole Scandinavia. Experts in the road salt field was contacted and interviewed. Information that was of interest was what kind of salt, such as NaCl , MgCl_2 and CaCl_2 , that was used. Limitations of substances, such as toxic metal compounds, for the different countries were also investigated. The size fraction of the salt crystals is an important parameter but this is not analysed in depth.

3.2 Extraction of salt from the process on Langøya

The experiment to recover salt from fly ash was performed at the NOAH AS facility on Langøya in Norway. The fly ash is treated in different steps in the process on Langøya. The experiment was performed for ash slurry extracted from three different positions at three different times. That means that totally nine samples were extracted. The sample positions can be seen in Figure 8.

- The first sample was extracted from vessel 809 see Figure 12. This sample is an ash slurry with a pH value >12 . The high pH value contributes to high leaching of toxic metals.
- The second sample was extracted from the R4 vessel, see Figure 12. Here sulfuric acid is mixed with the fly ash slurry from vessel 809, which creates gypsum. The low pH value contributes to low leaching of toxic metals.
- The third sample was extracted from the brine that is diverted into the Oslo Fjord. This brine has passed through a water treatment plant (Breinholt Jensen, 2016).



Figure 12 a) 809 vessel from a view above and b) the drain crane for the R4 vessel.

The samples were extracted from the process at 2016-02-11, 2016-02-23 and 2016-03-02. Approximately a 4.5 kg sample was taken from each sample position mentioned above. All the 4.5 kg samples were vacuum filtered through a filter paper from Whatman. The filter paper with a diameter of 110 mm was ashless. This filter paper collects small particles ($<2\ \mu\text{m}$) and is commonly used for determination of insoluble particles.

For the filtration a Büchner funnel made of porcelain with fritted glass and an Erlenmeyer flask with a side arm was used. To the side arm a tube was connected that lead to a vacuum source. Between the Büchner funnel and the Erlenmeyer flask a rubber bung was connected to ensure no air leakage. All of the six samples extracted from the process were filtered one by one. See Figure 13.

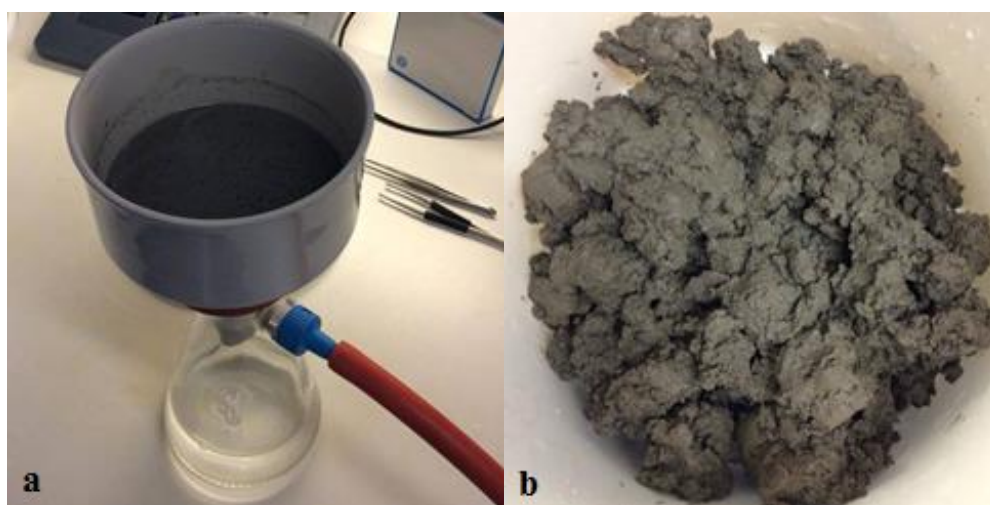

Figure 13 a) Vacuum filtration of fly ash from the R4 tank. In the bottom of the Erlenmeyer flask the transparent salt brine is shown. b) Remaining ash mud after filtration

All the insoluble ash particles were removed by filtration and a transparent water like solution remained. Approximately 2.5 kg of brine was produced for each of the 4.5 kg ash slurry samples. The remaining ashes were not analysed further.

For each of the six remaining brines a 50 ml sample was sent to an external company for ion chromatography. This is a method for analysing the amount of different cations and anions, which was done to estimate the amount of different salts such as, KCl, NaCl, MgCl_2 and CaCl_2 . From the ion chromatography the theoretical total amount of anhydrous salt per kg brine was calculated. From this, the total amount of salt with crystallised water such as $\text{MgCl}_2 \cdot 6\text{H}_2\text{O}$ and $\text{CaCl}_2 \cdot 2\text{H}_2\text{O}$, was calculated.

The remaining brines were heated to its boiling point in a pan until nearly all water was evaporated and the salt crystals were precipitated. The consistence at this time was viscous slurry. The remaining moisture was then evaporated in an around 160°C oven.



Figure 14 Pictures shows the evaporation process from salt brine to crystallised salts. These pictures are for salts leached from tank 809, 2016-02-23. a) Brine after that the brine was heated for 35 minutes. b) Viscous slurry after boiling process (90 minutes). c) Dry crystallised salt after drying in the oven.

The crystallised salts recovered from the three different positions were sent to be analysed with respect to metals, sulphate (SO_4), total organic carbon (TOC), total hydro carbon (THC) and pH value.

All metals were analysed with inductively coupled plasma (ICP), by NOAH AS, which is a mass spectrometry technology. This is done by ionizing the sample with inductively coupled plasma. A mass spectrometer is then used to separate and quantify the ions. The salt analysed with ICP was dissolved with nitric acid. This method is commonly used for the detecting of metals and also several non-metals. TOC, THC and pH were analysed externally by another company.

Mean values from these results were then calculated and compared with the requirements for road salts in Scandinavia.

3.3 Brine evaporation

The future facility in Brevik will be located close to a cement industry. This cement industry is today emitting waste heat in terms of flue gas. The temperature of the flue gas leaving the furnace is around 380°C . The mass flow of the flue gas is about 42 kg/s. This flue gas is then quenched with water to a temperature around 230°C before it is routed the atmosphere, (Breinholt Jensen, 2016). In this part of the thesis it will be investigated if it is possible to use this heat source for crystallise salt from the brine extracted on Langøya. The water will be removed in a multiple effect evaporator process followed by a rotary drier. Both the high temperature position (380°C) and the low temperature position (230°C) in flue were of interest in this investigation.

The calculations were performed for brine with the same composition as the brine extracted from vessel 809. This means that the concentration of anhydrous salts into the evaporation facility is 17 wt%, see Table 8. The salt is not totally dried in the multiple evaporation facility. In this study the concentration were increased to 90 wt% anhydrous salt. The remaining water has to be removed in a rotary drier. However the salt extracted from vessel 809 contains CaCl_2 with crystallised water, which means that the final product still contain 7 wt% water molecules. This means that the final product out from the rotary drier contains 93 wt% anhydrous salts.

The evaporating process uses steam as a heat source and the energy released to condense the steam is used for the evaporating process. Therefore steam has to be produced in a heat recovery steam generator (HRSG), which uses the heat in the flue gas. The flue gas at the two different positions is assumed to be an ideal gas with a specific heat capacity equal 1 kJ/kgK. The change in total energy of an ideal gas is given by equation 6 (Nikolai, 1997).

$$\Delta Q = \dot{m}(h_2 - h_1) = \dot{m}C_p(T_2 - T_1) \quad [J] \quad (6)$$

where:

ΔQ = Transferred heat [kW]

C_p = Specific heat capacity [kJ/kgK]

\dot{m} = mass flow [kg/s]

T = Temperature [°C]

h = Enthalpy [kJ/kg]

As seen from equation 6, a high flue gas inlet temperature (T_1) and a low flue gas exhaust temperature (T_2) entail a large energy exchange. However the exhaust flue gas temperature from the HRSG needs to be at least 150°C since the flue gas is containing sulphur. A lower temperature than this will result in sulphur dew point corrosion (Nikolai, 1997). In Figure 15 a schematic picture of a heat exchanger is presented. This picture is relevant for all type of heat exchangers discussed in this study, including the HRSG.

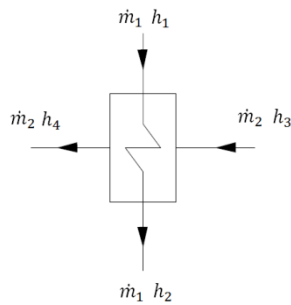

Figure 15 Principle of a heat exchanger

If no heat losses to surrounding are assumed in the heat exchanger, the heat balance is according to equation 7.

$$(h_1 - h_2)\dot{m}_1 = (h_4 - h_3)\dot{m}_2 \quad (7)$$

where:

\dot{m} = mass flow [kg/s]

h = Enthalpy [kJ/kg]

All heat exchangers in the process are assumed to be counter flow heat exchangers and minimum pinch points of 30°C are assumed. This can easily be seen in a temperature-heat flux diagram. A schematic picture of a temperature-heat flux diagram for a HRSG producing saturated steam is presented in Figure 16. Position 1 and 3 symbolise the inlet- respectively outlet temperature of the flue gas. Position 6 and 4 symbolise the inlet- respectively outlet temperature for the water. The minimum pinch point is here the temperature difference between point 2 and 5.

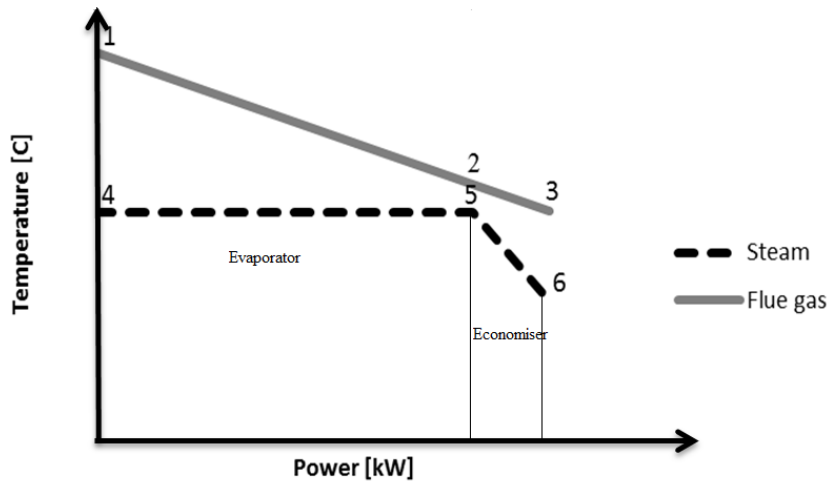

Figure 16 Schematic temperature-heat flux diagram

Further the temperature of the feed water into the HRSG has to be 120°C. This temperature is reached in the feed water tank, see Figure 17.

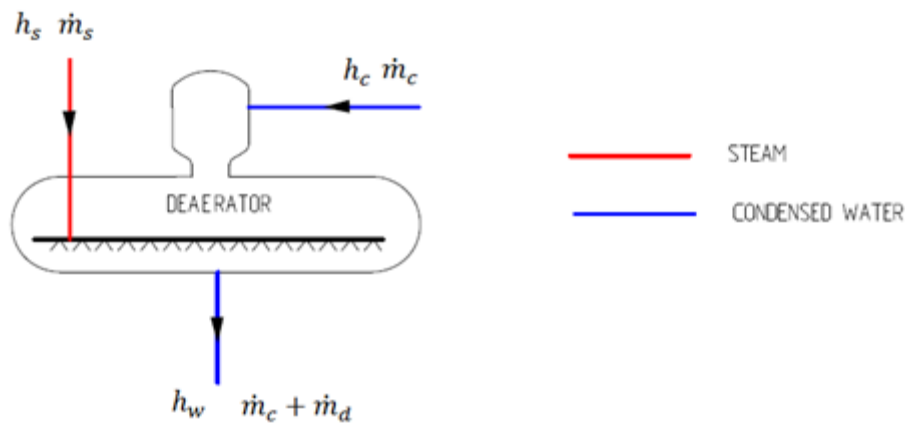

Figure 17 Principle of a feed water tank with a deaerator

A deaerator is used to remove oxygen and other dissolved gases such as CO₂ from the condensate and feed water. This is necessary to avoid corrosion in the HRSG (Nikolai, 1997). Steam is used to strip the gas, which then is released through a vent valve in the top of the deaerator. The energy into the deaerator needs to be the same as the energy out from the deaerator, see equation 8 (Nikolai, 1997).

$$h_c \dot{m}_c + h_s \dot{m}_s = h_w (\dot{m}_c + \dot{m}_d) \quad (8)$$

where:

\dot{m} = mass flow [kg/s]

h = Enthalpy [kJ/kg]

Heat exchangers are also designed to preheat the brine before entering the evaporation facility. For this, hot condensate is used. The energy balance is given by equation 7 above.

Two different multiple effect evaporators were then designed; one for the high temperature process and one for the low temperature process. The number of effects

depends on the temperature of the heat source, which in this case is saturated steam produced by the flue gas. The pinch points for the heat exchangers in the evaporators are also here set to 30°C. In Figure 18, a schematic flow chart of an evaporation effect is presented.

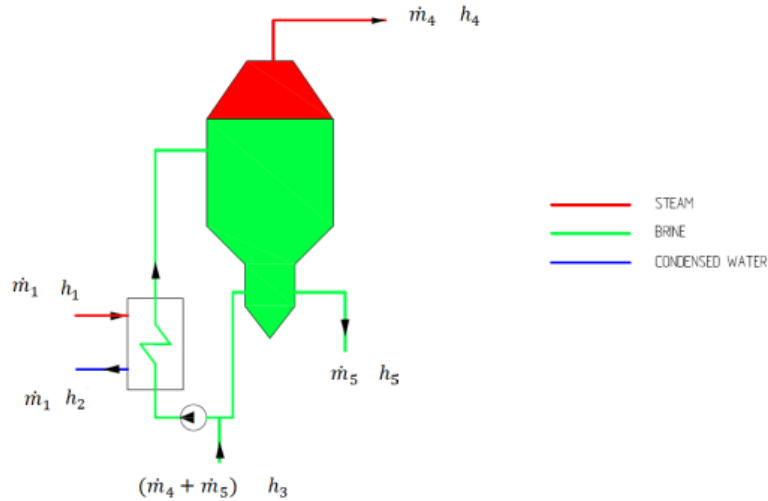

Figure 18 Principle of a single evaporation effect

According to Figure 18 following energy balance applies, see equation 9 (Nikolai, 1997).

$$\dot{m}_1(h_1 - h_2) + (\dot{m}_4 + \dot{m}_5)h_3 = \dot{m}_4h_4 + \dot{m}_5h_5 \quad (9)$$

where:

\dot{m} = mass flow [kg/s]

h = Enthalpy [kJ/kg]

As mentioned before it is stated that the preheated brine into the first effect contains 17 wt% anhydrous products and the brine exit the last effect contains 90 wt% of anhydrous salt. In the evaporation facility the brine reaches supersaturation due to removal of vapour. To optimize the evaporation facility, the brine was preheated with the condensed live steam before entering the first effect of the evaporation process.

For this study it was assumed that all salts were fed through the whole evaporation process. In reality there may be advantages to extract salts between all the different effects. The thermodynamic properties for the brine were also assumed to be the same as for water.

Between all effects a throttle is used to reach the new lower pressure in the next effect. Also pumps are used to feed the brine. Both the throttles and pumps are assumed to work isentropic. When saturated water is fed through a throttle, steam is created. In this study this is neglected since the amount of steam produced by the throttles is small compared to the steam produced in the evaporators (Nikolai, 1997).

4 Regulations for road salt in Scandinavia

The salt extracted from the process on Langøya has to meet the today's limitations to be approved as road salt. In this chapter regulatory framework for the Scandinavian countries is presented. In addition a future European standardisation concerning salts is presented since it will probably be of great importance in a few years. Important parameters for road salt is moisture content, amount of other substances than salts, such as toxic metals, pH value, anti-caking agents, size fraction of the salt crystals and proportion of different salts for blends. The size fraction of the salt crystals is an important parameter. If the crystals are too small it leads to large lumps and the time for the salt to be dissolved will increase. Too large crystals will also increase the dissolution time. However, all this data is not stated in detail in this report but to give a glimpse of how the requirements for crystal fraction might look, Table 1 below shows the Norwegian requirement.

Table 1 Salt fraction analyse for road salt in Norway

Salt fraction analysis for road salt in Norway	
Sieve size [mm]	Salt sifted through the sieve [wt%]
0.125	≤ 5
1	20-100
4	80-100
6.3	100

4.1 European standardisation

The European Committee for Standardization (CEN) has developed a new standard for road salt usage, which most likely will be released 2017-07-08 (CEN, 2016). CEN, also called European standard, is a federation that establishes standards for 33 European countries. CEN is one of three standardization organizations in Europe. European committee for Electro technical Standardization (CENLEC), and European Telecommunication Standards Institute (ETSI) is the other two. The CEN organization is located in Brussels and is cooperation with the European Union since 2013-01-01. CEN is an organization for development of European Standards and technical documents. CEN establishes standards for many different sectors such as chemicals, construction, etc. (CEN, 2016).

The CEN plays an important role for the European market. It makes it easier for companies to sell their products or services to customers around Europe (CEN, 2016).

It is important to note that this is only a standard and not a regulation but it will probably have a great impact in the long term because there are no clear regular frameworks existing today. Standards are voluntary and regulations are mandatory (CEN, 2015). The European standard for road salt usage specifies requirements of NaCl, MgCl₂ CaCl₂ and multi chloride blends for using on roadways for winter maintenance. The requirements are specified for salt both in crystallised form and for salt in brine (Azifi, 2016).

Something all of the different salts have in common is the limitations for the presence of toxic metals compounds and THC. In Table 2 this limitations are stated.

Table 2 General chemical requirements for NaCl, MgCl₂, CaCl₂ and KCl

General chemical requirements for NaCl, MgCl ₂ , CaCl ₂ and KCl	
Parameter	Limit [mg/kg]
Metals	
Aluminium	≤ 50
Arsenic	≤ 2.5
Cadmium	≤ 2
Cobalt	≤ 2
Chromium	≤ 5
Copper	≤ 5
Mercury	≤ 0.5
Nickel	≤ 5
Lead	≤ 5
Zinc	≤ 20
THC	≤ 100

Note 1- The determination of toxic metal compounds is done for pH 4 and is stated as mg/kg anhydrous product.

For natural based salts like rock salt, solar salt and vacuum salt the amounts of aluminium and total hydro carbon (THC) is negligible. Therefore determination of these substances only needs to be done for by-product salt.

As has been mentioned, there are also specific requirements for the size fraction of the crystals, which is stated in coming CEN standard (CEN, 2016).

4.1.1 Sodium chloride

NaCl in crystallised form can be divided into three groups depending on the moisture content; dry NaCl, semi-dry NaCl and wet NaCl. For NaCl stored in a silo dry salt is recommended to avoid caking. For rock salt a maximum of 0.2 wt% moist is recommended and for vacuum salt 3.5 wt% moist is recommended. Specific requirements for NaCl in crystallised form and NaCl in brine are presented in Table 3. Further, a test with 10 litres of brine shall pass through a sieve with a size of 0.5 mm. After washing with water on the sieve no insoluble residues should be remaining.

Table 3 Specific requirements for NaCl in crystallised form and in brine

Requirements for NaCl					
Parameter	Limit, dry NaCl	Limit semi-dry NaCl	Limit wet NaCl	Limit, brine	Unit
Moisture ⁽²⁾	≤ 0.6	≤ 2.0	≤ 6.1	-	wt%
NaCl ⁽¹⁾	≥ 90			18 – 26	wt%
Sulphate	≤ 3 ⁽¹⁾			≤ 0.6 ⁽⁴⁾	wt%
Anti-caking agent ⁽³⁾	3-125			-	mg/kg
Water insoluble matters	-			≤ 0.03	wt%
pH ⁽⁴⁾	5-10			-	-

Note 1- The amount of sulphate for crystallised salt and the amount NaCl is given in wt% of anhydrous product. Note that the concentration of NaCl is measured as total chloride content and sulphate is measured as water soluble sulphate.

Note 2- The moist contents are expressed as H₂O in the delivered undried salt. A minimum moisture content above 0.2 wt% is recommended to avoid dust during handling.

Note 3- Sodium-, potassium- or calcium ferrocyanide should primarily be used but other anti-caking agents than ferrocyanide are also allowed if it has same characteristics.

Note 4- In brines, pH and sulphate is determined for a solution with 10 wt% NaCl.

4.1.2 Magnesium chloride

The CEN-standard comprises also restrictions for usage of MgCl₂. MgCl₂ can be delivered as flakes, prills, pellets and as brine. In Table 4 general chemical requirements for MgCl₂ can be found.

Table 4 General chemical requirements for MgCl₂

Requirement for MgCl ₂			
Parameter	Limit, flakes, pellets, prills	Limit, brine	Unit
Chlorides			
MgCl ₂	≥ 46.5	16 – 33	wt%
Other chlorides	≤ 5.0 ⁽¹⁾	≤ 5.0 ⁽²⁾	wt%
Water insoluble matter	≤ 0.5 ⁽¹⁾	≤ 0.1 ⁽²⁾	wt%
Sulphate	≤ 1.5 ⁽¹⁾	≤ 1.0 ⁽²⁾	wt%
pH	5-11 ⁽²⁾		-

Note 1- Other chlorides (expressed as NaCl), sulphate (SO₄) and insoluble matter are determined as wt% in anhydrous product.

Note 2- In brine other chlorides (expressed as NaCl), sulphate (SO₄), pH and insoluble matter are determined in a 10 wt% solution.

In addition to this, TOC has to be presented for MgCl₂ that is produced from a secondary source like fly ash. TOC is used to determine the environmental impact of the product. No specific limits are set for TOC in the CEN-standard today.

4.1.3 Calcium chloride

CEN is also preparing a standard for usage of CaCl₂ as road salt. CaCl₂ is used both as de-icing agent and for dust control and stabilization of gravel roads. CaCl₂ can be delivered as flakes, pellets, prills, granules and as a brine. In Table 5 general chemical requirements for MgCl₂ can be found.

Table 5 General chemical requirements for CaCl₂

General chemical requirements for CaCl ₂				
Parameter	Limit			Unit
	Flakes	Pellets, prills granules	Brine	
Chlorides				
CaCl ₂	≥ 75	≥ 94	16 - 36	wt%
Other chlorides ⁽¹⁾		≤ 5.0 ⁽¹⁾	≤ 5.0 ⁽²⁾	wt%
Water insoluble matter		≤ 0.5 ⁽¹⁾	≤ 0.2 ⁽²⁾	wt%
Sulphate ⁽¹⁾		≤ 0.5 ⁽¹⁾	≤ 0.5 ⁽²⁾	wt%
pH		5-11 ⁽²⁾		-

Note 1- Other chlorides (expressed as NaCl), sulphate and insoluble matter are determined as wt% in anhydrous product.

Note 2- In brine other chlorides (expressed as NaCl), sulphate (SO₄), pH and insoluble matter are determined in a 10 wt% solution.

In addition to these chemical requirements, TOC has to be analysed for CaCl₂ for the same reason as for MgCl₂.

4.1.4 Salt blends

Blends can either be produced by mixing specific salts or as a by-product. Multi chloride blends can either be MgCl₂ with NaCl and/or KCl or it can be CaCl₂ with NaCl and/or KCl. General chemical requirements for blends are presented in Table 6.

Table 6 General chemical requirements for blends

General chemical requirements for blends [mg/kg]			
Parameter	Solid blends	Liquid blends	
		MgCl ₂ as a basis	CaCl ₂ as a basis
Sulphate ⁽²⁾	≤ 1.5	≤ 1.0 ⁽⁴⁾	≤ 0.5 ⁽⁴⁾
MgCl ₂	≥ 10 ⁽¹⁾	≥ 2.5	
CaCl ₂	≥ 10 ⁽¹⁾	≥ 2.5	
MgCl ₂ , CaCl ₂ , NaCl, KCl	-	≥ 16 ⁽³⁾	
Water insoluble matter	-	≤ 0.2	

Note 1- The concentration CaCl₂ respectively MgCl₂ shall be measured as wt% of total accumulation of salts including CaCl₂, MgCl₂, NaCl and KCl. The concentration shall be calculated as dry product.

Note 2- The concentration is measured for dry product.

Note 3- The total amount of MgCl₂, CaCl₂, NaCl, KCl shall be at least 16 wt%

Note 4- Sulphate shall be measured in a solution with a concentration of 10 wt% with anhydrous product.

The content of metals shall succeed the values in Table 2. As for MgCl₂ and CaCl₂, TOC has to be determined for blends produced from fly ash.

4.2 Requirements for road salt in Norway

The Norwegian roadways is requiring around 200 000 tonnes of salt annually for de-icing (Freddy Knudsen, 2014). Norway is only handling salts in crystallised form. Statens Vegvesen Vegdirektoratet are managing snow and ice on the Norwegian roads. Vegdirektoratet is not handling the salt, they are just hiring contractors and make sure to maintain clear roads. Norway is, like the other countries in Scandinavia, using mainly NaCl as de-icing agent. The minimum content of NaCl is regulated to 98 wt% of anhydrous product. Other salts like MgCl₂ and CaCl₂ are also used to maintain the roads. These are mostly used for dust control and stabilization of gravel roads but in exceptional cases it is also used as de-icing agent. The salt should beyond this conform to the requirements in Table 7 (Vegvesen, 2014).

Table 7 Requirements for Norwegian road salt

General requirements for Norwegian road salt		
Parameter	Limit	Unit
Content of other water soluble salts, for example SO ₄ , Ca and Mg	≤ 1.0	wt%
Content of other water soluble substances	≤ 1.0	wt%
Water content for salt produced from sea water	≤ 4.0	wt%
Water content in rock salt,	≤ 1.0	wt%
Water content in salt produced vacuum process.	≤ 3.0	wt%
Content of anti-caking agent, sodium ferrocyanide.	≤ 100	mg/kg

Note 1- The substances is expressed as wt% of anhydrous product

There are no precise limits for heavy metals and salts today and the reason is probably that only original salt is used, which has low levels of metals. All road salt in Norway is today purchased in dry crystallised form but there are four different methods to spread the salts on the roads.

- Spreading of dry crystallised salt. This method is only used when the roadway is wet.
- Spreading of humidified salt. Salt and water is mixed in the plow trucks spreader and normally a mixture of 30 wt% salt is used. Min 25 wt% salt is a requirement to ensure an effective de-icing agent.
- Spreading of fine grained humidified salt. All of the salt crystals should be able to pass through a 4 mm sieve and 50 wt% should be able to pass to a 1 mm sieve. Moreover, the same rules apply as for spreading of humidified salt.
- Spreading of brine. The brine should have as high salinity as possible and a minimum salinity of 20 wt%.

The reason that Norway is buying all salt in crystallised form is the lower transportation cost. The brine is therefore produced in Norway by mixing dry crystallised salt and water.

4.3 Requirements for road salt in Sweden

Sweden spreads around 200 000 tons of salt as de-icing agent annually. Trafikverket, the Swedish traffic organisation, manages the roads all over the country. Trafikverket is not a purchaser of road salt and is not responsible for the distribution of the salt. Trafikverket hires contractors who purchase the salt and distribute it on the roadways.

In Sweden there is a limit of 97 wt% pure NaCl. The remaining 3 wt% is mainly moisture and gypsum. There is also a small part of sodium ferrocyanide, which is added by the supplier, to avoid caking. Furthermore, Trafikverket has a ban list with forbidden substances. In this list substances like lead, cadmium and mercury are stated. Substances in this list are not allowed to use if nothing else is specified. However, this restriction is unclear since there always are small concentrations of toxic metal compounds. It is thus no accurate specification for substances in the road

salt. Trafikverket strives for salt not containing more toxic substances than the background nature where the salt is used (Trafikverket, 2015).

Furthermore, they rank chemicals in four groups with perspective to environmental impact, BASTA- and BETA-criteria (Trafikverket, 2014). However there are no labelling requirements for road salt in Sweden, which means that the content of substances is unclear.

In addition to this the amount of carbon dioxide in ton per kg produced salt is of great interest. There are no limits for this today but these restrictions are likely to be tightened in the future. This can probably open up opportunities for salt recovered from fly ash.

Most of the Swedish road salt is purchased as rock salt. This salt is pure and cheap and it is possible to decide the size of the salt particles. However, vacuum salt is sometimes used in southern Sweden as well as sea salt.

4.4 Requirements for road salt in Denmark

Road salt that is used in Denmark is mostly NaCl but MgCl₂ and CaCl₂ are also used. Sometimes also urea and calcium acetate are used as de-icing agent. Denmark is using around 40 000- 100 000 tonnes of salt annually. In Denmark Vejdirektoratet is managing the roads but, like in Norway and Sweden the contractors are the ones handling with the salt. The road salt used in Denmark shall not contain substances that can be harmful for human or the environment in normal use. Further, the road salt should not contain any substances that can substantially reduce the friction of the road way (Vejdirektoratet, 2006).

NaCl is delivered as sea salt, rock salt or vacuum salt. Following information must be presented when delivering NaCl.

- Particle shape/structure of the NaCl particles. This affects the salts ability to clumping.
- Salt fraction analysis.
- Moisture content when delivering.
- Amount and type of anti-caking substance. The maximum amount is 150 mg/kg if potassium ferrocyanide is used and 120 mg/kg if sodium ferrocyanide is used.
- Content of other substances than NaCl, both soluble and insoluble. The maximum content for soluble substances is 1,5 wt%.

Regulations for moisture content of NaCl are different depending on the salts origin. The maximum content of moisture is 3 wt% for vacuum salt, 4 wt% for sea salt and 1 wt% for rock salt.

CaCl₂ and MgCl₂ are also used in Denmark, mostly at temperatures below -15 C. CaCl₂ can also be used in mix with NaCl to achieve a better result. Further, CaCl₂ and MgCl₂ are used for dust control and stabilization of gravel roads in Denmark.

Following information must be presented when delivering CaCl_2 and MgCl_2 (Vejdirektoratet, 2006).

- Particle size and shape/structure.
- Content of CaCl_2 determined as anhydrous product.
- If it is delivered in crystallised form, brine or powder.
- Content of other substances than NaCl , both soluble and insoluble. The maximum content for soluble substances is 2 wt%.

5 Results and discussion

Based on the aim and objectives with this study, the results are presented and discussed in this chapter.

5.1 Salt composition

By the filtration process brines were generated. An important parameter is the amount of salts dissolved in the brine. A higher concentration entails lower energy usage during the crystallisation process. The results from the ion chromatography are presented in Appendix B – Raw data. The elements are presented as ions dissolved in the water. To calculate the proportion of different salts created when evaporating all the water, an assumption is made. It is assumed that all chlorides is bonded to K, Mg, Ca respectively Na. Determinations also shows that the amount of Cl is consumed at the same time as all the metals K, Mg, Ca and Na are consumed. This confirms that the assumption was reasonable. In Table 8 the amount of different salts dissolved in the brine is presented. As can be seen, the brine from all the three sample points consists of mostly NaCl, CaCl₂ and KCl. Low concentrations of MgCl₂ are also presented. It can also be seen that the highest concentration of salts is in the brine extracted from vessel 809 where the concentration of anhydrous salt is 17.3 wt%. The diverted brine has low concentrations of salts because the brine is diluted by rainfall. For this reason, brines extracted from vessel R4 and 809 are of greater interest.

Table 8 Salt concentration in brines from three different positions in the process

Salt concentration in brine [wt%]			
Parameter	R4, pH<12	809, pH>12	Diverted brine
NaCl	5.5	7.0	3.5
KCl	2.9	3.8	1.7
MgCl ₂	0.2	0.0	0.1
CaCl ₂	3.5	6.4	1.9
Sum anhydrous salt	12.2	17.3	7.1
Crystallised water H ₂ O	1.4	2.1	0.7
Sum salt, crystallised water	13.6	19.4	7.9

The salt in the brines generated from the three different sample positions were crystallised. The colours of the generated salts vary, see Figure 19. The reason for the red hue, for the salts extracted from R4 vessel and from the salt extracted from the brine diverted to the sea, is the increased amount of iron, which originates from the sulfuric acid.



Figure 19 Salt extracted from the process on Langøya. The picture shows a) 809, b) R4 and c) diverted brine. The sample positions can be seen in Figure 8.

In Table 9, the proportions of different anhydrous salts are presented. As seen the highest concentration is NaCl in all the three different samples. The reason that the amount of CaCl₂ is lower in the R4 vessel than in vessel 809 is the reaction between the sulfuric acid and the calcium that creates solid gypsum that precipitates from the brine, see equation 10



Table 9 Proportion of different salts for anhydrous products

Proportion of different salts for anhydrous product [wt%]			
Parameter	R4, pH<12	809, pH>12	Diverted brine
NaCl	45.4	40.5	48.4
KCl	24.1	22.2	24.0
MgCl ₂	2.0	0.0	1.7
CaCl ₂	28.5	37.3	26.0
Sum	100	100	100

If the values instead is presented for CaCl₂*2H₂O and MgCl₂*6H₂O, the concentrations of different salts in the dry product are different, see Table 10. These values are of great interest since the salt, CaCl₂ and MgCl₂ are traded with crystallised water and the price is also presented for salt with crystallised water.

Table 10 Proportion of different salts for salt with crystallised water

Proportion of different salts for salt with crystallised water [wt%]			
Parameter	R4, pH<12	809, pH>12	Diverted brine
CaCl ₂ *2H ₂ O	33.9	44.1	31.2
KCl	21.6	19.8	21.7
MgCl ₂ *6H ₂ O	3.8	0.0	3.2
NaCl	40.8	36.1	43.9
Sum	100	100	100

Since specific limits for toxic materials, like toxic metal compounds are unclear for the Scandinavian countries, these parameters are compared with the CEN standard. For metals and THC the limits are independent of what kind of salt that is studied. The generated salts from Langøya compared with the CEN standard can be seen in Table 11. For specific values for all the different samples, see Appendix B – Raw data. The values are also compared with a NaCl rock salt that is spread on the Scandinavian roads today. As can be seen, all values are within the limits and most of them with a comfortable marginal. The only value that is close to the limit is zinc for the salt extracted from vessel 809. As can be seen in Appendix B – Raw data, this value is also over the limits, 24, respectively 29 mg/kg, for two of the three different samples. This is equal to a standard deviation of 11,2. Salt extracted from vessel 809 may therefore cause problem when trading it as road salt if the zinc is not removed. The amount of zinc can probably be reduced by decreasing the pH value, which causes precipitation of zinc. For salt extracted from vessel R4 and from the diverted water, all values are well within the limits. It can also be seen that the values for the salt extracted from vessel R4 and from the diverted brine is close to the values for the rock salt, which contributes to good opportunities for further usage as road salt. A higher pH value entails that more metal compounds are leached to the brine. This is the reason for the higher amount of metal compounds such as zinc and aluminium in vessel 809 than in the R4 vessel.

Table 11 Content of toxic substances for the three different salt samples

Content of toxic substances [mg/kg]					
Parameter	CEN limits	Rock salt	R4, pH<12	809, pH>12	Diverted brine
Metals					
Aluminium	≤ 50	---	3.2	4.4	3.1
Arsenic	≤ 2.5	0.4	0.4	0.4	0.4
Cadmium	≤ 2	0.02	0.50	0.02	0.03
Cobalt	≤ 2	0.1	0.1	0.1	0.3
Chromium	≤ 5	0.1	0.1	0.1	0.1
Copper	≤ 5	0.1	0.1	0.1	0.1
Mercury	≤ 0.50	---	0.02	0.02	0.02
Nickel	≤ 5	0.2	0.2	0.2	0.2
Lead	≤ 5	0.2	0.2	1.0	0.2
Zinc	≤ 20	0.1	0.3	18.7	0.1
THC	≤ 100	---	20.2	20.4	20.6

Note 1- Values are stated as mg/kg anhydrous product

Sulphate, pH and TOC are also important parameters since the approaching CEN standard regulates this. The limits are different for brines and salt in crystallised form. In Table 12 these values are presented for the salts extracted from Langøya. The limits, presented in the CEN standard, for pH and sulphate are also different for different type of salts, see Chapter 4.1. However, the pH value for both brine and crystallised salt is outside the limit for salts extracted from vessel 809. Salts extracted from the diverted brine and the R4 vessel, are both within the limits for all type of salts.

For CaCl₂ in crystallised form, the limit for sulphate is set to 0.5 wt%. This means that the content of sulphate is outside the limit for salt extracted from the R4 vessel and from the diverted brine. However, it is hard to draw any conclusions from this since the salt extracted from Langøya is a mix of different salts. How the sulphate is distributed when separating the salts from each other is not investigated in this study. The amount of sulphate in the crystallised salt is within the limits for all other types of salts. The amount of sulphate is also within the limits for salts in brine. TOC has to be presented for salt generated as a by-product but there are no limits for this parameter.

Table 12 Values for pH, sulphate and TOC

Values for pH, sulphate and TOC			
Parameter	R4, pH<12	809, pH>12	Diverted brine
Crystallised salt			
pH	8.3	11.5	8.4
Sulphate	0.8	0.4	1.9
TOC	0.1	32.4	0.1
Brine			
pH	8.3	11.5	8.4
Sulphate ⁽¹⁾	0.1	0.1	0.2

Note 1- The concentration of sulphate is for a 10 wt% solution

Norway and Sweden use NaCl as a de-icing agent. This means that the salts have to be separated. Denmark is sometimes using blends as de-icing agents but the restrictions for the proportions is unclear. In this case, it could be an opportunity to use the salt extracted from Langøya without any separation. Sweden, Denmark and Norway are however using either CaCl₂ or MgCl₂ for dust stabilization of gravel roads.

The new CEN standard that will be released opens up opportunities to use both CaCl₂, MgCl₂ and multi chloride blends as de-icing agent in Sweden and Norway. However, there are still restrictions for the proportion of different salts in multi chlorides blends. The blends can either be traded as solid blends or as liquid blends, see Table 6. For solid blends there is a minimum requirement of 10 wt% of MgCl₂ and CaCl₂ respectively. This is not the case for the salt extracted from Langøya. The amount of MgCl₂ is far below 10 wt%. Nor for liquid blends the properties of different salts are within the limits. The amount of MgCl₂ has to be at least 2.5 wt%. These limits can be reached by addition of MgCl₂.

Separate salts from each other and trade it as pure NaCl, MgCl₂, CaCl₂ respectively KCl is also an opportunity. Different salts have different properties and it can therefore be an advantage to trade it separately. For example, KCl can be used for production of fertilizers for agriculture. To some extent, this can be done during the evaporation process, which will be discussed later.

Moisture content is irrelevant in this case, since this can be regulated during the evaporation and drying process of the salt. Insoluble matters depend on the filtration process, which in this case is done in a laboratory. The anti-caking substance is added separated to the salt and is not analysed. The size fractions of the salt crystals can be affected during the evaporation process but this is not investigated in this study.

The salts extracted from Langøya have a low concentration of toxic metal compounds, especially salts extracted from the R4 vessel. The concentration of salts in the brine extracted from R4 is also high.

5.2 Evaporation and drying process

For the brine generated from vessel 809, two evaporation and crystallisation processes have been designed. The concentration of salts in the brine extracted from vessel 809 is 17 wt% and is used in these calculations. Two different Heat recovery steam generators (HRSG) were designed, one using flue gas with a temperature of 230°C and one using flue gas with a temperature of 380°C. By this, saturated steam can be generated at two different pressures. High temperature and pressure of the steam is desirable but if the temperature and pressure are too high, the transferred amount of heat will decrease. Thus, this is a balance.

In Figure 20 below, the temperature-heat flux diagram for the low temperature HRSG is presented. The feed water with a temperature of 120°C and a pressure of 4 bars is heated in the economiser to 143°C. Further on this water is evaporated to saturated steam.

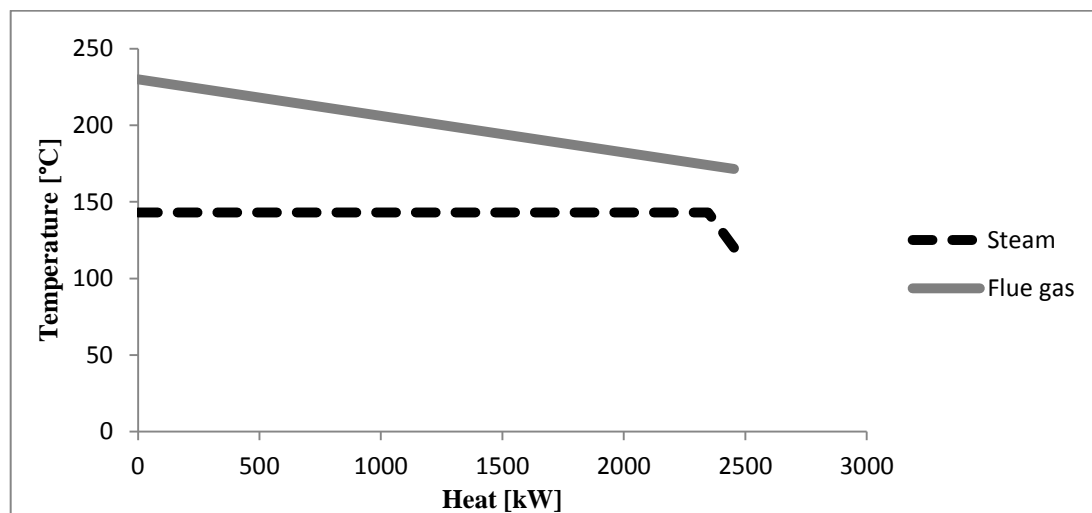

Figure 20 Temperature-heat flux diagram for low temperature process

In Figure 21 the temperature-heat flux diagram for the high temperature HRSG is presented. Here 212°C saturated steam at 20 bars pressure is produced.

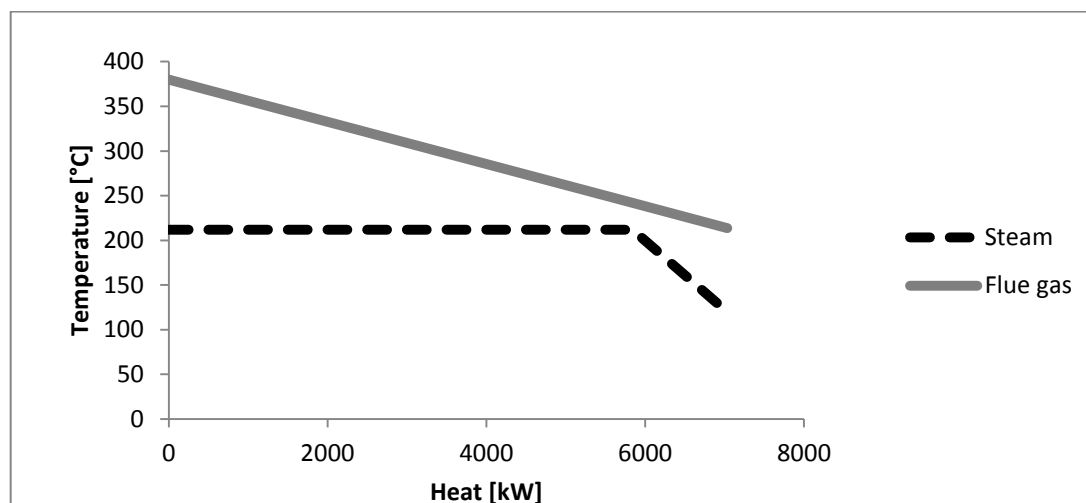

Figure 21 Temperature-heat flux diagram for high temperature process

In Table 13 the two different HRSG are compared. As can be seen, more than twice as much heat is transferred for the high temperature HRSG, which means a steam mass flow of 1.1 kg/s respectively 3.1 kg/s. Further the pinch point is around 30°C in both cases.

Table 13 Summary, low-, and high temperature HRSG

	HRSG 1 (low temperature)		HRSG 2 (high temperature)	
	Flue gas	Water/steam	Flue gas	Water/steam
Inlet temperature [°C]	230	120	380	120
Outlet temperature [°C]	172	143	213	212
Pressure [bar]	1	4	1	20
Mass flow [kg/s]	42	1	42	3
Min pinch [°C]	31		30	
Transferred heat [kW]	2454		7034	

A small part of the produced steam is directly recirculated to the deaerator and the remainder is fed to the first effect in the evaporator. In Figure 22, a flow chart for the low temperature process is presented. Here all the important values are presented and as can be seen two effects are possible. However, it is calculated that 2.2 kg_{brine}/s can be fed into the process if the concentration of anhydrous salt constantly should be 90 wt% out from the last effect in the evaporator. Note that the brine is preheated with condensate from the live steam before entering the first effect. The mass flow out from the last effect is 0.41 kg/s. This is further fed to the drier where the concentration of anhydrous salt is increased from 90 wt% to 93 wt%. The mass flow of the final product out from the dryer is 0.39 kg/s. In Appendix C – Heat balances for low temperature process data for heat exchangers, evaporation effects, deaerator and rotary dryer are presented.

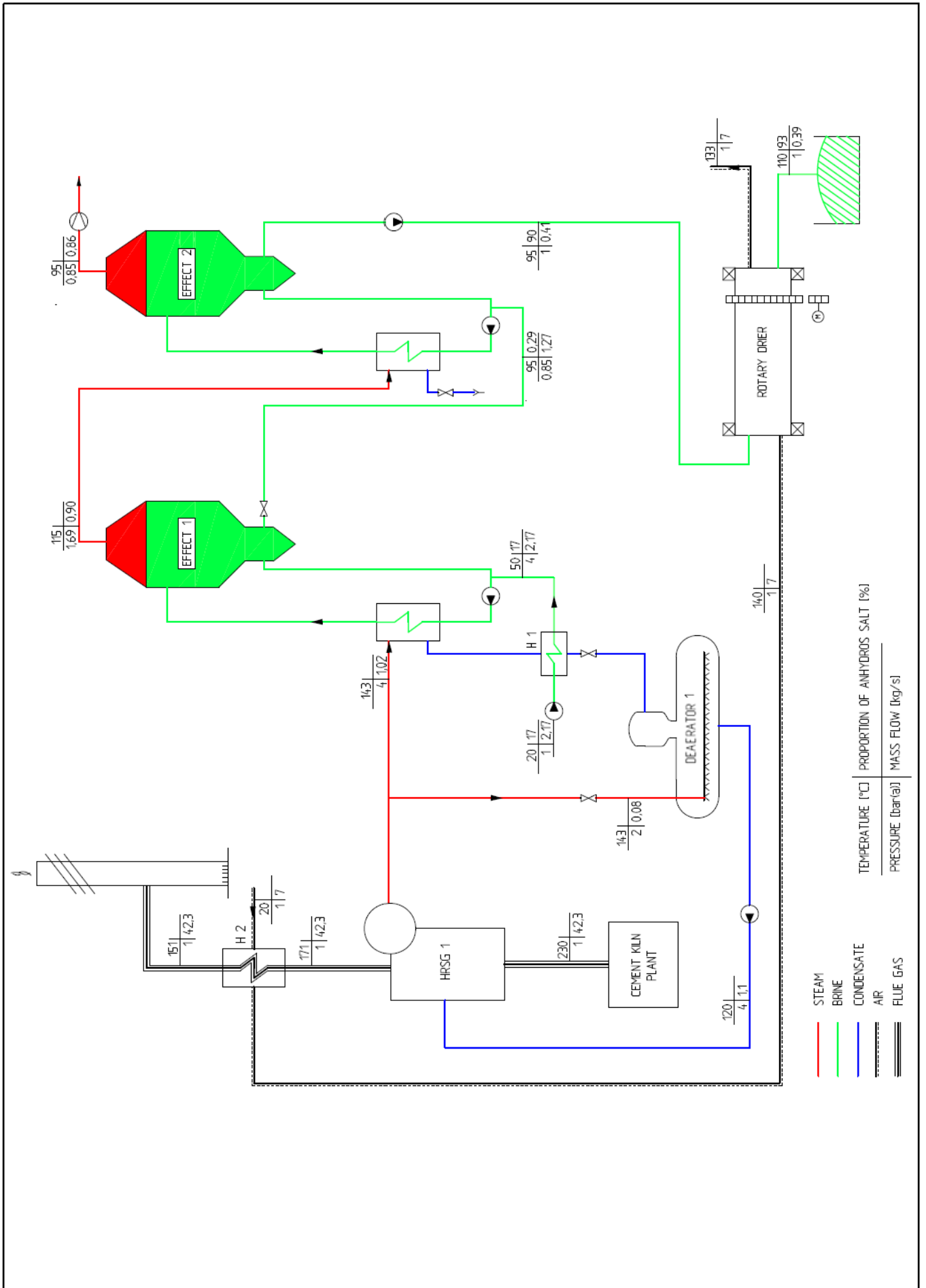

Figure 22 Low temperature multiple effect evaporation facility with two effects

In Figure 23, the flow chart for the high temperature process are shown where also all important values are presented. The principle is the same as for the low temperature evaporator facility. Since the temperature and pressure of the live steam is higher, 5 effects are possible. Here, 13.2 kg_{brine}/s are fed into the first effect. This brine is preheated in two steps. The mass flow out from the last effect is 2.5 kg/s. The slurry containing 90 wt% anhydrous salt is then dried in the rotary dryer to 93 wt% anhydrous salt. The mass flow of the final product out from the dryer is 2.4 kg/s. In Appendix D – Heat balances for high temperature process, data for heat exchangers, evaporation effects, deaerator and rotary dryer are presented.

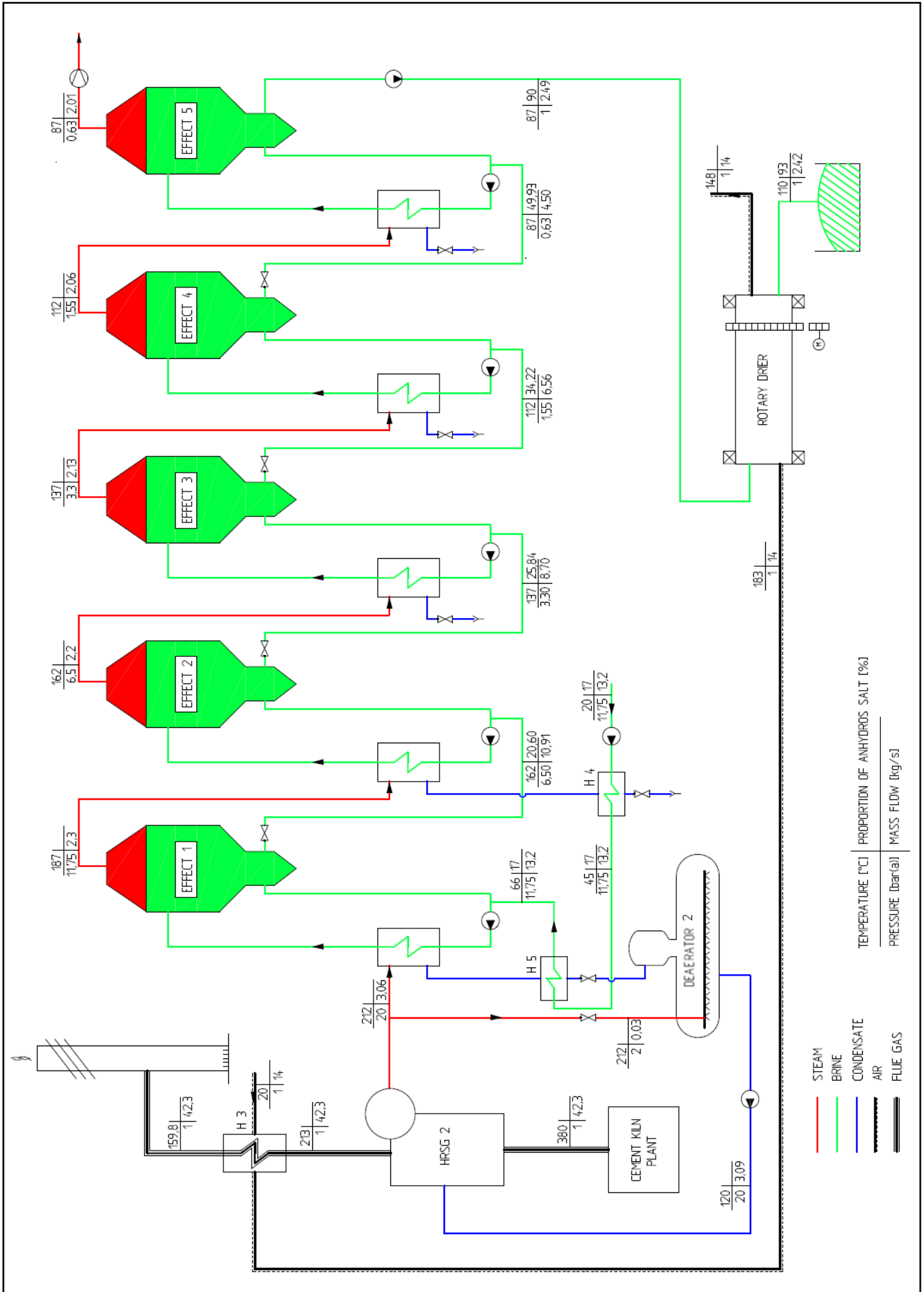

Figure 23 High temperature multiple effect evaporation facility with five effects

In Table 14, a summary is stated. As expected, the high temperature process is much more efficient. The amount of produced salt is also much higher for the high temperature process. Since the high temperature process has 5 effects the process is more complex and the installation cost will be higher. This is however not discussed in this project.

Table 14 Summary of low- and high temperature evaporation facility

	Low temperature process (230°C)	High temperature process (380°C)
Number of effects	2	5
Flue gas energy usage [MW]	2.5	7.0
Inlet mass flow of brine (17 % anhydrous salt) [ktonnes/year]	62.5	380.2
Outlet mass flow (93 % anhydrous salt) [ktonnes/year]	11.2	69.7
Evaporated water [ktonnes/year]	50.7	308.2
Efficiency [$\text{kg}_{\text{product}}/\text{MJ}$ flue gas]	0.2	0.3

For the further facility in Brevik around 100 000 tonnes of salts can be extracted from the fly ash annually. This means that there is energy enough to crystallise around 69 %. This applies only if the concentration of salts in the extracting brines will be the same in Brevik as on Langøya. It is possible to re-circulate the water through the process, which probably increases the concentration of salts in the brine. This entails a lower energy use during the evaporation and more crystallised salt can be produced. A risk with recirculating is that a larger amount of toxic metals also leaches to the brine.

Another alternative is just to increase the salt concentration and trade it as brine. The transportation costs will be higher for brines than salts in crystallised form but it can probably be an alternative for roads nearby. The storage will also be larger for brine, which can be an economic and practical problem. Even for salt in crystallised form the storage might be thought due the high hygroscopic characteristics for MgCl_2 and CaCl_2 . The salt has to be stored in storage with dry humidity.

In addition to this, it can be worth considering what the waste heat can be used for if it is not used for crystallising salt. There might be other alternative that can be positive in both cost and environmental perspective.

6 Conclusions

Salt was extracted from three different positions in NOAH's facility on Langøya. The most important thing in this study was to find out whether the properties of the extracted salt reaches the regularly framework in Scandinavia today. Since the regulatory framework for road salt in Scandinavia today is flawed, many parameters were compared to a new CEN-standard, which handles road salt. The concentration of toxic metals is well within the limits for the salt extracted from the R4 vessel and from the diverted brine. For salt extracted from vessel 809 the concentration of zinc is close to the limit, which is probably due to the high pH value. Further the pH value is too high for the salt extracted from vessel 809. Since the salt extracted from the R4 vessel is neutralised with sulfuric acid the pH value is lower and within the limits. This means that in this case the salt extracted from the R4 vessel is the best alternative. However the concentration of salts in the R4 vessel is lower than in the vessel 809. This is a drawback during the crystallisation process.

The salt extracted from all the samples is a mixture of mainly CaCl_2 KCl and NaCl . A small part is also MgCl_2 . Today most of the salt used for de-icing is NaCl , mainly because of the low price. Other salts are also used sometimes for de-icing and CaCl_2 and MgCl_2 are also used for dust control of gravel roads. A mix of different salts is used sometimes but there are still regulations for the proportions of different salts. The salts extracted from Langøya are not totally within these limits.

There are two ways to solve this problem. One way is to add specific salts to reach the right proportions for the blend. The other way is to separate the different salts from each other. This can probably be done during the crystallisation process.

The salt can be traded both as brine and in crystallised form. Most of the salt is today traded in crystallised form due to the lower transportation cost. For NOAH's further facility in Brevik waste heat from Norcem AS cement industry can be used to evaporate the water in the brine. Two different calculations were performed for two different temperatures of the waste heat, 230 °C and 380 °C. The multiple effect evaporation facility designed for the highest temperature was found to be much better. The high temperature evaporation facility was designed with 5 effects and a following drier. From this process around 380 000 tonnes can be evaporated annually. This means a total production of around 70 000 ton of salts annually, which corresponds to 18 % of the total consumption of road salt in Scandinavia. The high temperature evaporating facility produces more than six times more salt than the low temperature evaporation facility, which only has two effects.

In a multiple effect evaporator there are also possibilities to separate different salts from each other, which can be desirable. If the different salts are separated from each other, KCl can be used for production of fertilizer for the agriculture. There is a company that has succeeded to separate salts, with similar compositions, from each other, which prove that this is possible (Ragn-Sells, 2016). There is a great potential in this project and the obstacles are small. There are still some areas, which need to investigate in more detail before a complete concept can be presented.

7 Further challenges

- The salt extracted from Langøya is a mix of mainly CaCl_2 , KCl and NaCl . It may be favourable to trade with the salts separated from each other. This separation might eventually be done during the evaporation process by utilizing precipitation of various salts at different concentrations. To know if this is possible, further tests need to be done. A test where the brine is evaporated in many steps and where the precipitated crystals after each step are separated by filtering should be performed. All these salt samples must then be analysed. NaCl and CaCl_2 have saturation points far away from each other and are thus theoretically easy to separate. It is more difficult to separate NaCl from KCl . The temperature of the brine during the evaporation in different steps can also be varied since the solubility as a function of temperature is various for different salts. In a real process the precipitated salt crystals have to be extracted between each step. By changing the number of effects and the pressure in each effect, the concentration and amount of precipitated crystals can be varied. In this way salts can be separated from each other, completely or partially.
- The concentration of toxic metal compounds in the salt extracted from Langøya is low, especially for the salt extracted from the R4 vessel. However it is still unclear how the toxic substances are affected if the salts are separated from each other. A new test for separated salts has to be done to assure that not all toxic metals are bound to a certain salt. This can entail that the toxic contents are above the limits.
- The energy usage during the evaporation process can be minimised by increasing the concentration of salts in the incoming brine. This can eventually be done by recirculating the water that is used for leaching the salts from the fly ash. A risk with this is that also the concentration of toxic metals increase in the brine. Further test with recirculating water can advantageously be carried out.
- An important parameter for road salts is the fractions of the crystals. Different evaporation technologies lead to different size of the salts. This has to be investigated in more detail.
- A possibility is to trade the salt as brine. The amount of energy during the evaporation process will reduce but on other hand the transportation- and storage cost will increase. An economic- and environmental evaluation has to be prepared.

- An economic calculation for both running cost and the fixed cost for installation of a new facility has to be prepared. The revenues for the traded salt should cover these costs.
- Analyse the salts in order to find out if there are presence of other toxic substances, such as dioxins. It is not likely but should still be checked for safety.

8 List of literature

Allan, 2015. [Online]

Available at: <http://www.sciencegeek.net/Chemistry/taters/solubility.htm>

[Used 24 04 2016].

Anon., 2009. [Online]

Available at: <http://pudeb.com/reciprocating-grate-wood-boiler-and-heating-systems-wellons-fei/>

[Used 22 05 2016].

Anon., 2012. <http://www.fhwa.dot.gov/publications/research/safety/95202/005.cfm>.

[Online]

Available at: <http://www.fhwa.dot.gov/publications/research/safety/95202/005.cfm>

[Used 03 06 2016].

Azifi, A., 2016. *Interview With Anissa Azifi, CEN, Brussel* [Intervju] (11 02 2016).

Breinholt Jensen, M., 2015. *Ny behandlingsmetode av farlig avfall med CO₂-rik røykgass*, u.o.: NOAH AS.

Breinholt Jensen, M., 2016. [Intervju] (15 02 2016).

CEN, 2016. *European Committee for standardization*. [Online]

Available at: <https://www.cen.eu/about/Pages/default.aspx>

[Used 15 02 2016].

CEN, 2016. *European Committee for standardization*. [Online]

Available at: <https://www.cen.eu/about/RoleEurope/Pages/default.aspx>

[Used 15 02 2016].

CEN, 2016. *Winter service equipment and products - De-icing agents -Part 1: Sodium chloride - Requirements and test methods*, Brussel: European committee for standardization.

CEN, 2016. *Winter services equipment and products - De-icing agents - Part 2: Calcium chloride and Magnesium chloride - Requirements and test methods*, u.o.: CEN.

Cewep, 2009. *Enviromentally sound use of bottom ash*, u.o.: Cewep.

Choi, B. S., 2005. *CRYSTALLIZATION CHARACTERISTICS OF NaCl CRYSTAL SIZE DISTRIBUTION ASSOCIATED WITH A CMSMPR CRYSTALLIZER*, u.o.: The University of Utah.

Demmer, R., 2014. *Vission on winter road maintenance*, u.o.: Akzo Nobell.

Eide, F., 2016. *Hansson % Möhring* [Intervju] (18 02 2016).

Freddy Knudsen, K. N. A. A. B. N. K. M. R., 2014. *Vintertjeneste i de Nordiske land. Statusrapport 2014*, Norge: NVF.

GEA, 2012. *Mass Crystallization from solutions*, Duisburg: GEA.

- Geertman, R. M., 2000. *Sodium Chloride: Crystallization*, u.o.: Akzo Nobel.
- Gustafsson, M., Blomqvist, G., Jonsson, G. & Ferm, M., 2010. *Effekter av dammbindning av belagda vägar*, u.o.: IVL.
- Hailong, T., Aris, E. & Yangsheng, L., 2014. *Recovery of soluble chlorides salts from the wastewater generated during the washing process of municipal solid wastes incineration fly ash*, Beijing: Peking University.
- Karlfeldt Fedje, K., 2010. *Metals in MSWI fly ash - problems or opportunities*, Göteborg: Chalmers University of Technology.
- Larson, D., 2008. [Online]
Available at: <http://www.foothill.edu/attach/psme/sinha.fpdepression.pdf>
[Used 14 03 2016].
- Marit Læg Reid , 2014. *Oppsummering av aske fra A til Å*, u.o.: NOAH AS.
- Metso, 2010. *Metso Power AB*. u.o.:u.n.
- Nayak, M., 2012. *Design and simulation of a multiple-effect evaporator using vapor bleeding*, u.o.: Department of chemical engineering national institute of technology, Rourkela.
- Nikolai, V. K., 1997. *Advanced energy systems*. Berlin: Taylor & Francis.
- NOAH, 2016. [Online]
Available at: <http://www.NOAH.no/wp-content/uploads/2016/03/Behandlingssted-Lang%C3%B8ya.jpg>
[Used 13 05 2016].
- NOAH, 2016. *NOAH AS*. [Online]
Available at: <http://www.NOAH.no/For-kunder/Behandlingssteder/Lang%C3%B8ya>
[Used 14 03 2016].
- Peña, J. A. P., 2011. *Bubbling Fluidized Bed (BFB), When to use this technology?*, Madrid: Foster Wheeler Global Power Group.
- Ragn-Sells, 2016. *Ragn-Sells*. [Online]
Available at: <http://www.mynewsdesk.com/se/ragnsells/pressreleases/kommersiella-salter-utvinns-ur-aska-fraan-avfallsfoerbraenning-1402014>
[Used 17 05 2016].
- Rasmussen, E., 2015. *Sambehandling af RGA og scrubber væske fra forbrændingsanlæg med HALOSEP processen*, København: Miljøstyrelsen.
- Renova, u.d. [Online]
Available at: <http://www.renova.se/om-renova/anlaggningar/avfallskraftvarmeverket/>
[Used 21 05 2016].

Ronald D. Bell, G. E. S. F. B. M. M. R. G., u.d. *CALCIUM CARBONATE SCRUBBING OF HYDROGEN CHLORIDE IN FLUE GASES*, Texas: u.n.

Sassan, S., 2009. *Human Settlement Development*. 3 red. Oxford: UNESCO.

Teir, S., 2002. *Modern Boiler Types and Applications*, Helsinki: Helsinki University of Technology Department of Mechanical Engineering .

Trafikverket, 2014. *Trafikverket*. [Online]

Available at: <http://www.trafikverket.se/for-dig-i-branschen/miljo/Material-och-kemiska-produkter/Farliga-amnen-i-material-och-varor/Kriterier-for-bedomning-av-farliga-amnen-i-material-och-varor/>

[Used 19 02 2016].

Trafikverket, 2015. *Trafikverket*. [Online]

Available at: <http://www.trafikverket.se/resa-och-trafik/underhall-av-vag-och-jarnvag/Sa-skoter-vi-vagar/Vintervaghallning/Vagsalt/>

[Used 01 02 2016].

Trafikverket, 2015. *Trafikverket*. [Online]

Available at: <http://www.trafikverket.se/resa-och-trafik/underhall-av-vag-och-jarnvag/Sa-skoter-vi-vagar/Vintervaghallning/Vagsalt/Om-vagsalt/>

[Used 01 02 2016].

Vegvesen, S., 2014. *D2 Tegninger og supplerende dokumenter D2-ID9300a Bruk av salt*, u.o.: Statens vegvesen.

Vejdirektoratet, 2006. *VEJEDRIFT Tømidler, sand og grus til glatførebekæmpelse*, u.o.: u.n.

Westin, J., 2013. *Avfallsverige*. [Online]

Available at: <http://www.avfallsverige.se/statistik-index/avfallsstatistik/>

[Used 29 01 2016].

Wikman, K., Berg, M. & Nordin, A., 2003. *Termisk rening av askor*, Stockholm : u.n.

Wikström, A., 2016. *Saltning av vintervägar - en otidsenlig metod*, Luleå: Luleå tekniska universitet.

9 Appendix A – Flow sheet

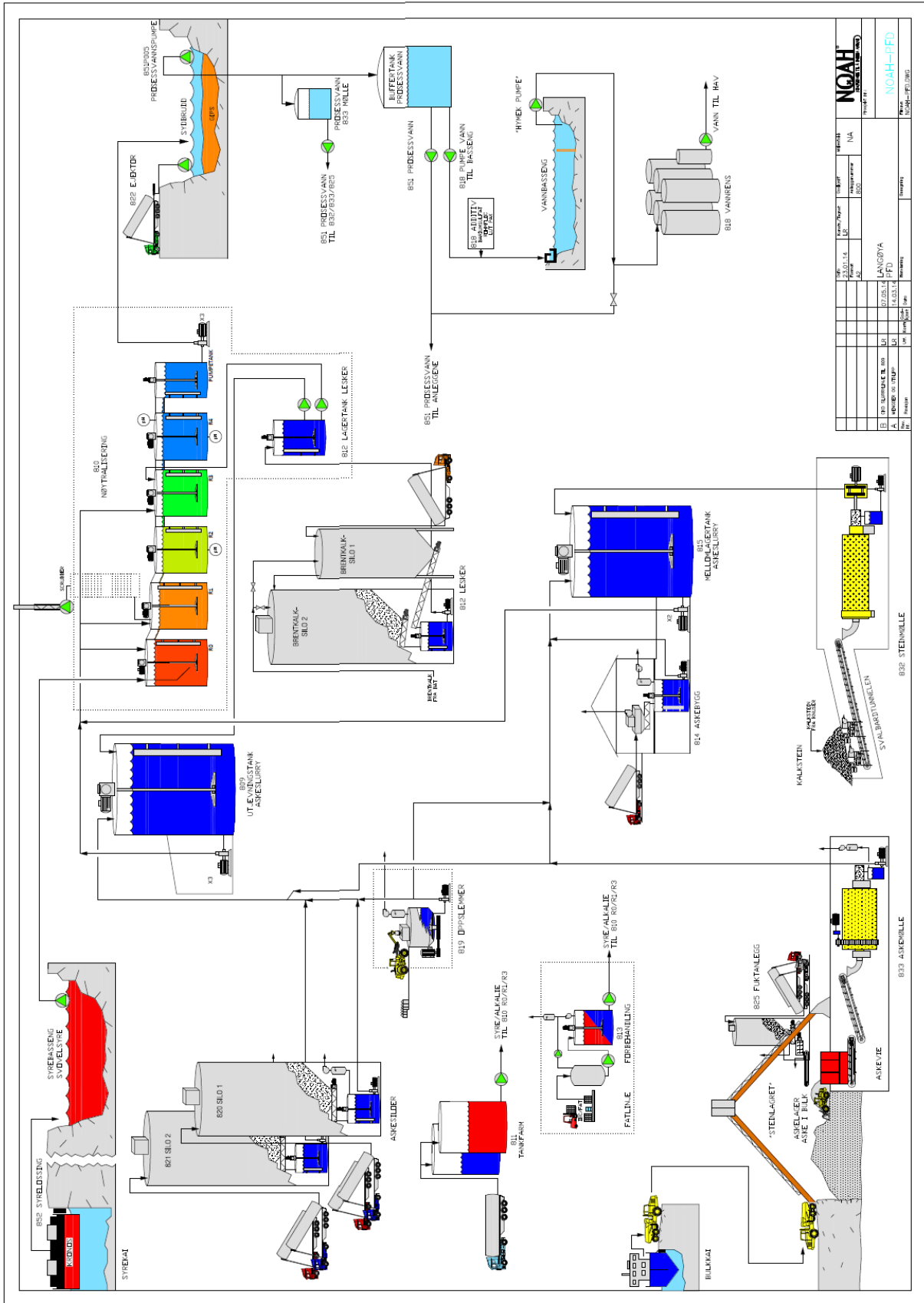

10 Appendix B – Raw data

Parameter	809	R4	809	R4	Diverted brine	809	R4	Diverted brine	R4	Diverted brine	Unit
	11-feb	11-feb	23-feb	23-feb	25-feb	01-mar	01-mar	01-mar	01-mar	01-mar	
pH	11,30	8,10	11,80	8,50	7,80	11,50	8,30	8,90	-		
As	0,40	0,40	0,40	0,40	0,40	0,40	0,40	0,40	0,40	0,40	mg/kg TS
Ba	81,00	66,00	110,00	42,00	21,00	110,00	78,00	23,00	23,00	23,00	mg/kg TS
Cd	0,02	0,49	0,02	0,36	0,02	0,02	0,65	0,03	0,03	0,03	mg/kg TS
Co	0,10	0,10	0,10	0,10	0,49	0,10	0,10	0,10	0,10	0,10	mg/kg TS
Cr	0,10	0,10	0,10	0,10	0,10	0,10	0,10	0,10	0,10	0,10	mg/kg TS
Cu	0,10	0,10	0,10	0,10	0,10	0,11	0,10	0,10	0,10	0,10	mg/kg TS
Mo	0,44	0,47	0,30	0,49	0,49	2,70	0,38	0,39	0,39	0,39	mg/kg TS
Ni	0,20	0,20	0,20	0,20	0,20	0,20	0,20	0,20	0,20	0,20	mg/kg TS
Pb	0,43	0,20	0,51	0,20	0,20	2,00	0,20	0,20	0,20	0,20	mg/kg TS
Sb	0,40	2,10	0,40	1,70	0,82	0,40	2,40	0,78	0,78	0,78	mg/kg TS
Se	0,30	0,30	0,30	0,30	0,30	0,30	0,30	0,30	0,30	0,30	mg/kg TS
Sn	0,10	0,10	0,10	0,10	0,10	0,10	0,10	0,10	0,10	0,10	mg/kg TS
Tl	0,30	0,30	0,30	0,30	0,30	0,30	0,30	0,30	0,30	0,30	mg/kg TS
V	0,10	0,10	0,10	0,10	0,10	0,10	0,10	0,10	0,10	0,10	mg/kg TS
Zn	3,20	0,30	24,00	0,10	0,16	29,00	0,44	0,10	0,10	0,10	mg/kg TS
TN	7,50	430,00	13,00	860,00	460,00	10,00	640,00	260,00	260,00	260,00	mg/kg TS
THC	20,19	20,12	20,58	20,00	20,92	20,40	20,58	20,18	20,18	20,18	mg/kg TS
TOC	0,10	0,10	0,10	0,10	0,10	97,00	0,10	0,10	0,10	0,10	% TS
Al	6,67	3,21	2,75	3,94	3,03	3,78	2,59	3,20	3,20	3,20	mg/kg TS
Hg	0,02	0,01	0,02	0,02	0,02	0,02	0,02	0,02	0,02	0,02	mg/kg TS
Cl-	Not analysed	Not analysed	105 000	70 000	Not analysed	121 200	84 800	49 350	49 350	49 350	mg/L
F-	Not analysed	Not analysed	50	50	Not analysed	25	18	26	26	26	mg/L
NO3	Not analysed	Not analysed	50	50	Not analysed	20	10	31	31	31	mg/L
PO4	Not analysed	Not analysed	5	5	Not analysed	1	1	1	1	1	mg/L
SO4	Not analysed	Not analysed	753	1 200	Not analysed	938	1 220	1 570	1 570	1 570	mg/L
Ca	Not analysed	Not analysed	26 200	12 000	Not analysed	27 300	16 800	7 700	7 700	7 700	mg/L
K	Not analysed	Not analysed	22 400	18 200	Not analysed	23 800	17 100	10 300	10 300	10 300	mg/L
Mg	Not analysed	Not analysed	2	647	Not analysed	5	778	347	347	347	mg/L
Na	Not analysed	Not analysed	31 300	26 700	Not analysed	32 000	23 300	15 600	15 600	15 600	mg/L
Sr	Not analysed	Not analysed	67 100	25 000	Not analysed	62 500	28 100	20 400	20 400	20 400	µg/L

11 Appendix C – Heat balances for low temperature process

In following appendix heat balances for all equipment in the low temperature evaporator process are presented. All tables and figures below can be coupled the flow sheet presented in Figure 22

HRSG 1				
	Primary side		Secondary side	
	Flue gas inlet	Flue gas outlet	Water inlet	Steam outlet
Temperature [°C]	230.0	171.6	120.0	143.0
Pressure [bar]	1.0		4.0	
Cp [kJ/(kgK)]	1.0		4.2	---
Enthalpy [kJ/kg]	---		503.8	2738.0
Mass flow [kg/s]	42.0		1.1	
Heat of vaporization [kJ/kg]	---		2134.0	
Min pinch [°C]	31.1			
Transferred heat [kW]	2453.7			

Air heater (HX1)		
	Flue gas	Air
Inlet temperature [°C]	171.6	20.0
Outlet temperature [°C]	151.6	140.0
Cp [kJ/(kgK)]	1.0	1.0
Mass flow [kg/s]	42.0	7.0
Min pinch [°C]	31.6	
Transferred heat [kW]	840.0	

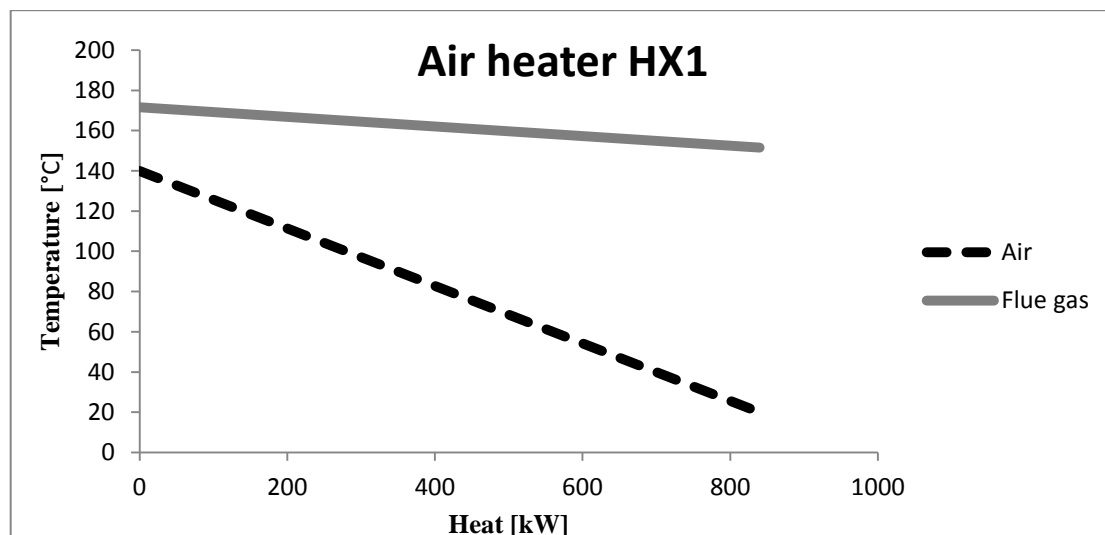

Brine preheater (HX2)		
	Condensate	Brine
Inlet temperature [°C]	143.0	20.0
Outlet temperature [°C]	80.0	49.7
Cp [kJ/(kgK)]	4.2	4.2
Mass flow [kg/s]	1.0	2.2
Min pinch [°C]	93.3	
Transferred heat [kW]	270.7	

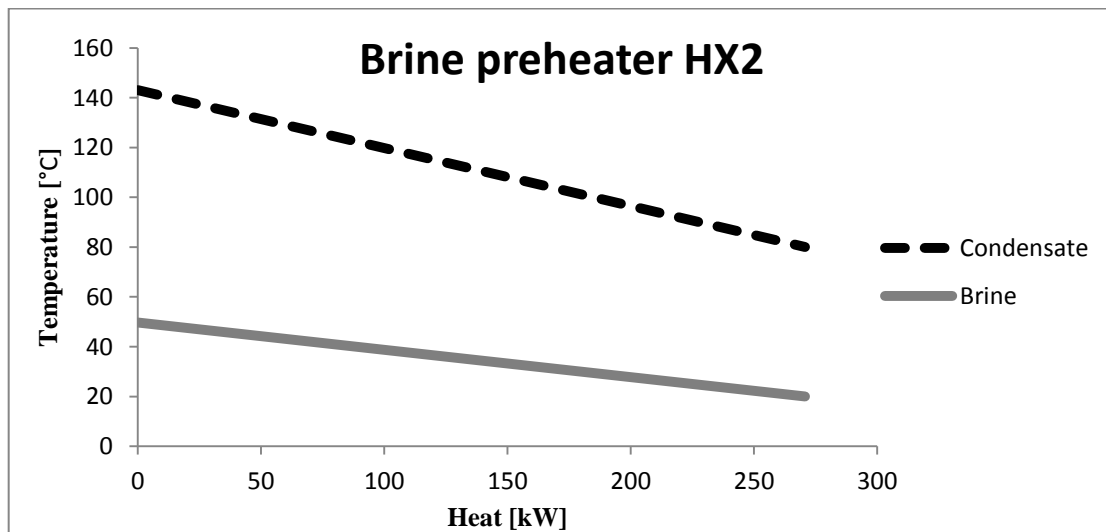

Effect 1		
	Steam	Brine
Heat steam [kW]	2800.9	2420.8
Transferred Heat [kW]	2183.0	2800.9
Pressure [bar]	4.0	1.7
Temperature inlet [°C]	143.0	56.4
Temperature outlet [°C]	143.0	115.0
Heat of vaporization [°C]	2130.0	2188.0
Mass flow steam [kg/s]	1.0	0.9

Effect 2		
	Steam	Brine
Heat steam [kW]	2395.5	2309.7
Transferred Heat [kW]	1962.3	1962.3
Pressure [bar]	1.7	0.9
Temperature inlet [°C]	115.0	95.2
Temperature outlet [°C]	115.0	95.2
Heat of vaporization [°C]	2188.0	2269.0
Mass flow steam [kg/s]	0.9	0.9

12 Appendix D – Heat balances for high temperature process

In following appendix heat balances for all equipment in the high temperature evaporator process are presented. All tables and figures below can be coupled the flow sheet presented in Figure 23

HRSG 2				
	Primary side		Secondary side	
	Flue gas inlet	Flue gas outlet	Water inlet	Steam outlet
Temperature [°C]	380,0	213,7	120.0	212.0
Pressure [bar]	1.0		20,0	
Cp [kJ/(kgK)]	1.0		4.2	---
Enthalpy [kJ/kg]	---		908.0	2798.0
Mass flow [kg/s]	42.3		3.1	
Heat of vaporization [kJ/kg]	---		1890.0	
Min pinch [°C]	29.9			
Transferred heat [kW]	7034.1			

Air heater (H 3)		
	Flue gas	Air
Inlet temperature [°C]	213.7	20.0
Outlet temperature [°C]	159.8	183.0
Cp [kJ/(kgK)]	1.0	1.0
Mass flow [kg/s]	42.3	14.0
Min pinch [°C]	30.7	
Transferred heat [kW]	2282.0	

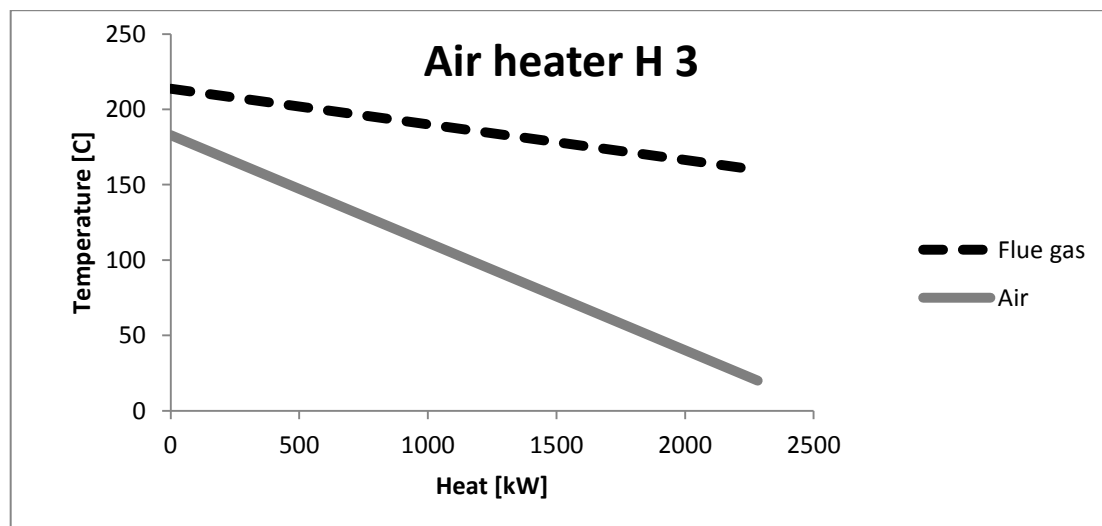

Brine preheater (H 4)		
	Condensate	Brine
Inlet temperature [°C]	187.0	20.0
Outlet temperature [°C]	50.0	44.0
Cp [kJ/(kgK)]	4.2	4.2
Mass flow [kg/s]	2.3	13.2
Min pinch [°C]	30.0	
Transferred heat [kW]	1330.2	

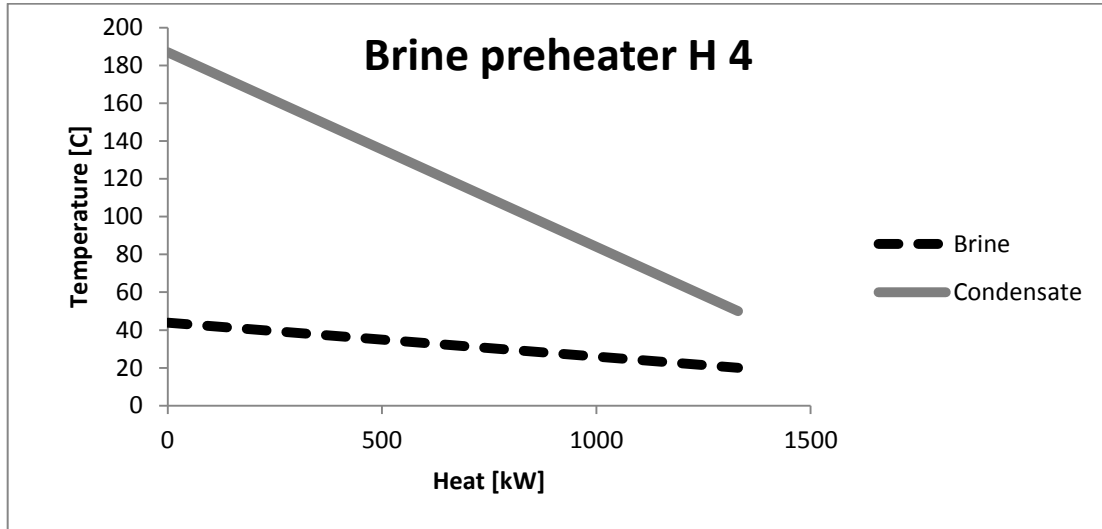

Brine preheater (H 5)		
	Condensate	Brine
Inlet temperature [°C]	212.0	44.0
Outlet temperature [°C]	115.0	66.6
Cp [kJ/(kgK)]	4.2	4.2
Mass flow [kg/s]	3.1	13.2
Min pinch [°C]	71.1	
Transferred heat [kW]	1258.9	

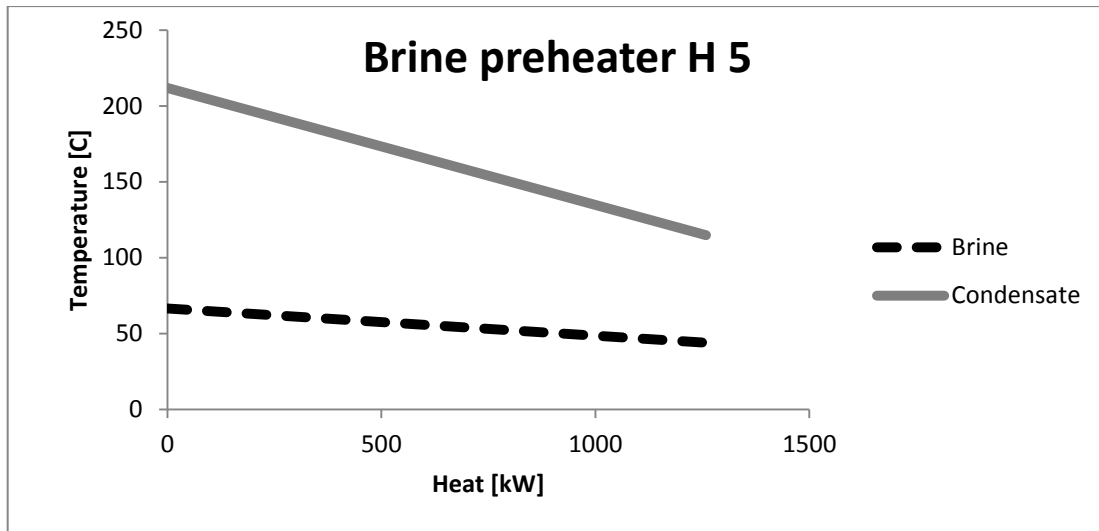

Effect 1		
	Primary side	Secondary side
Heat Steam[kW]	8569.9	6434.4
Transferred Heat [kW]	5786.7	5786.7
Pressure [bar]	20.0	11.8
Temperature inlet [°C]	212.0	63.9
Temperature outlet [°C]	212.0	187.0
Heat of vaporization [°C]	1890.0	1986.0
Mass flow steam [kg/s]	3.1	2.3

Effect 2		
	Primary side	Secondary side
Heat Steam[kW]	6407.1	6107.0
Transferred Heat [kW]	4591.31	4591.3
Pressure [bar]	11.8	6.5
Temperature inlet [°C]	187.0	162.0
Temperature outlet [°C]	187.0	162.0
Heat of vaporization [°C]	1986.0	2075.0
Mass flow steam [kg/s]	2.3	2.2

Effect 3		
	Primary side	Secondary side
Heat Steam[kW]	6096.9	5818.7
Transferred Heat [kW]	4591.3	4591.3
Pressure [bar]	6.5	3.3
Temperature inlet [°C]	162.0	137.0
Temperature outlet [°C]	162.0	137.0
Heat of vaporization [°C]	2075.0	2154.0
Mass flow steam [kg/s]	2.2	2.1

Effect 4		
	Primary side	Secondary side
Heat Steam[kW]	5817.8	5566.6
Transferred Heat [kW]	4591.3	4591.3
Pressure [bar]	3.3	1.6
Temperature inlet [°C]	137.0	112.0
Temperature outlet [°C]	137.0	112.0
Heat of vaporization [°C]	2154.0	2222.0
Mass flow steam [kg/s]	2.1	2.1

Effect 5		
	Primary side	Secondary side
Heat Steam[kW]	5563.3	5323.2
Transferred Heat [kW]	4591.3	4591.3
Pressure [bar]	1.6	0.6
Temperature inlet [°C]	112.0	87.0
Temperature outlet [°C]	112.0	87.0
Heat of vaporization [°C]	2222.0	2290.0
Mass flow steam [kg/s]	2.1	2.0