

CHALMERS



Methods of Increasing Thermal Efficiency of a Counter Flow Air to Air Heat Exchanger

An investigation of parameters influence on the thermal efficiency

Master of Science Thesis in the Master's Programme Structural Engineering and Building Performance Design

KARL LARSSON
FREDRIK PIHLQUIST

Department of Energy and Environment
Division of Building Services Engineering
CHALMERS UNIVERSITY OF TECHNOLOGY
Göteborg, Sweden 2011
Master's Thesis 2011:08

MASTER'S THESIS 2011:08

Methods of Increasing Thermal Efficiency of a Counter Flow Air to Air Heat Exchanger

An investigation of parameters influence on the thermal efficiency

*Master of Science Thesis in the Master's Programme Structural Engineering and
Building Performance Design*

KARL LARSSON

FREDRIK PIHLQUIST

Department of Energy and Environment
Division of Building Services Engineering
CHALMERS UNIVERSITY OF TECHNOLOGY

Göteborg, Sweden 2011

Methods of Increasing Thermal Efficiency of a Counter Flow Air to Air Heat Exchanger
An investigation of parameters influence on the thermal efficiency

Master of Science Thesis in the Master's Programme Structural Engineering and Building Performance Design

KARL LARSSON

FREDRIK PIHLQUIST

© KARL LARSSON & FREDRIK PIHLQUIST, 2011

Examensarbete / Institutionen för Energi och Miljö,
Chalmers tekniska högskola 2011:08

Department of Energy and Environment
Division of Building Services Engineering
Chalmers University of Technology
SE-412 96 Göteborg
Sweden
Telephone: + 46 (0)31-772 1000

Chalmers Repro Service / Department of Energy and Environment
Göteborg, Sweden 2011

Methods of Increasing Thermal Efficiency of a Counter Flow Air to Air Heat Exchanger
An investigation of parameters influence on the thermal efficiency

Master of Science Thesis in the Master's Programme Structural Engineering and Building Performance Design

KARL LARSSON

FREDRIK PIHLQUIST

Department of Energy and Environment

ABSTRACT

In passive and low-energy houses the energy consumption of the heating system should be minimized in order to meet the standards of such houses. The ventilation system should therefore be optimized to recover as much heat as possible from the exhaust air. The company REC Indovent produces air to air counterflow fixed plate heat exchangers for this type of houses. They provide two heat exchangers for this master thesis, which are tested practically with focus on thermal efficiency. The first one is a standard unit and the second is custom made with a smaller distance between the lamellas creating a denser heat exchanger.

Measurements show that the denser heat exchanger returned a higher thermal efficiency, likely because its larger heat transfer area. Experiments also show that the airflow was uneven distributed through the exchanger on the exhaust side since the fan is placed right before the heat exchangers inlet. Calculations showed that an even distributed airflow can improve the thermal efficiency. Air guides were used to direct the air more even and consequently the thermal efficiency was increased. The benefits of using air guides proved to be more distinct for the original heat exchanger than for the modified, since the last one showed a relatively good air flow distribution without using any type of air guidance. This is probably dependant on the fact that the pressure drop is larger for the modified unit than for the original one and then works as a diffuser. The use of air guides resulted in an increase of thermal efficiency from 73.0% to 78.4% for an airflow of 55 l/s and from 74.6 to 81.0% for an airflow of 86 l/s. The thermal efficiency of the heat exchanger with a larger surface area was measured to 82.3% for an airflow of 55 l/s and 80.8% for an airflow of 82 l/s.

The power consumption was logged during the test in order to predict how the modifications affected the Specific Fan Power, SFP. The SFP was slightly increased when using air guides in both units. The increase was measured to 0.01 kWh/(m³/s) for the lower airflow and up to 0.18 kWh/(m³/s) for the higher airflow.

Since an increased thermal efficiency and also a more compact product will increase the risk of attaining freezing damages in the heat exchanger, these modifications should also be tested during cold conditions when freezing is likely to occur.

Key words: air to air counter flow fixed plate heat exchanger, thermal efficiency, airflow distribution, air handling unit

Metoder för att öka temperaturverkningsgraden för en motströms plattvärmeväxlare
En undersökande studie av parametrar som inverkar på temperaturverkningsgraden
Examensarbete inom Structural Engineering and Building Performance Design

KARL LARSSON

FREDRIK PIHLQUIST

Institutionen för Energi och miljö

Avdelningen för Installationsteknik

Chalmers tekniska högskola

SAMMANFATTNING

För att möta kraven på energianvändning måste passivhus och lågenergihus med ett energieffektivt ventilationssystem med en värmeväxlare som möjliggör en hög återvinningsgrad av frånluftsvärme. REC Indovent är ett företag som tillverkar motströms plattvärmeväxlare till dessa hus. För detta examensarbete tillhandahåller de två värmeväxlare, en i standardutförande och en specialtillverkad med tätare lamellavstånd.

Mätningarna visade att den tätare värmeväxlaren gav en högre verkningsgrad, vilket troligtvis beror på en ökad värmeöverföringsarea. Vidare tester visade också att luftflödesfördelningen var ojämnt fördelad genom växlaren på frånluftsidan. Orsaken verkar vara att fläkten är placerad precis innan värmeväxlaren. Beräkningar tyder på att ett jämnt fördelat luftflöde kan öka temperaturverkningsgraden. Genom att styra luften med hjälp av luftguider kunde luftflödet fördelas så att en relativt jämn fördelning uppnåddes och en ökad temperaturverkningsgrad kunde påvisas. Ökningen visade sig vara tydligare för standardvärmeväxlaren än för den modifierade, då luftflödesfördelningen i den sista redan var relativt jämn. Orsaken till detta beror troligtvis på det ökade tryckfallet i den tätare värmeväxlaren jämfört med standardväxlaren. Det högre motståndet i växlaren kan få den att fungera som en diffusor. Användandet av luftguider resulterade i att verkningsgraden ökade från 73% till 78.4% för ett luftflöde på 55 l/s och från 74.6% till 81.0% för ett luftflöde på 86 l/s. Verkningsgraden för luftbehandlingsaggregatet med ökad värmeöverföringsarea kunde mätas upp till 82.3% för ett luftflöde på 55 l/s och 80.8% för ett luftflöde på 82 l/s.

Effekten loggades under experimenten för att få en bild av hur modifikationerna påverkar specifik fläkteffekt, SFP. SFP ökade något när luftguiderna installerades. Detta kunde mätas upp i båda aggregaten. Ökningen mättes upp till 0.01 kWh/(m³/s) för det låga flödet och upp till 0.18 kWh/(m³/s) för högflödet.

Då en ökad temperaturverkningsgrad och även en tätare produkt kan öka risken för att frysskador i värmeväxlaren kan uppkomma, bör dessa modifikationer också testas under kalla förhållanden då risk för frysskador föreligger.

Nyckelord: motströms plattvärmeväxlare, temperaturverkningsgrad,
luftflödesdistribution, luftbehandlingsaggregat

Contents

ABSTRACT	III
SAMMANFATTNING	IV
CONTENTS	V
PREFACE	VII
NOTATIONS	VIII
1 INTRODUCTION	1
1.1 Purpose	1
1.2 Objective	1
1.3 Delimitations	1
1.4 Method	1
2 THEORY	3
2.1 Heat transfer	3
2.1.1 Convection	3
2.1.2 Conduction	4
2.1.3 Radiation	4
2.2 Efficiencies	5
2.2.1 Thermal efficiency	5
2.2.2 Effectiveness	6
2.2.3 Energy efficiency	6
2.3 Heat exchanger	7
2.3.1 Logarithmic mean temperature difference	8
2.3.2 Rotary heat exchanger	9
2.3.3 Fixed plate heat exchanger	9
2.3.4 Condensation in heat exchanger	11
2.4 Thermal efficiency and effectiveness dependent on outdoor temperature	11
2.5 NTU method	13
2.6 U-value	14
2.7 Specific fan power	15
2.7.1 Fan	15
2.7.2 Air pressure in ductworks	15
3 EXPERIMENTS	17
3.1 Materials	17
3.1.1 Measuring equipment	17
3.1.2 Air handling unit and ductwork	18
3.1.3 Setup of test site	20
3.2 Verification of results	22
3.2.1 Temperature distribution in a channel	22

3.2.2	Deviation amongst the temperature meters	25
3.3	Determination of UA-value for a heat exchanger	26
3.4	Thermal efficiency of heat exchanger	28
3.5	Airflow distribution and effectiveness of the heat exchanger	32
3.6	Redistribution of air by air guides and the resulting thermal efficiency	39
3.7	Energy usage of air handling unit	50
4	UNCERTAINTIES IN RESULTS	52
5	AUXILIARY HEATING DEMAND	53
5.1	Duration diagram	53
5.2	Energy savings	55
6	CONCLUSIONS	57
6.1	Air Handling Unit 1	57
6.2	Air Handling Unit 2	57
6.3	Recommendations of further studies	58
7	REFERENCES	60

Preface

This master thesis has been carried out at the master's programme Structural Engineering and Building Performance Design, in the field of Building Services Engineering at the Department of Energy and Environment, Chalmers University of Technologies, Sweden.

The initiative to the master thesis was taken by the company REC Indovent. The tests have been performed at Chalmers on air handling units provided by REC Indovent.

Throughout the project we have had guidance that has brought us forward. We would therefore like to thank our supervisor Anders Trüschel and Mattias Gruber for their valuable help during the thesis, examiner Jan-Olof Dahlenbäck and Håkan Larsson for his support in the laboratory. REC Indovent played an important role, especially through Björn Frännhagen and Claes Jäderholm.

Karl Larsson and Fredrik Pihlquist

Göteborg May 2011

Notations

Roman upper case letters

A	Cross-sectional area [m ²]
A_{Aux}	Area of auxiliary heating demand in duration diagram [cm ²]
A_s	The specific area of the heat transfer surface [m ²]
C_e	Heat capacity rate of the exhaust air [W/K]
C_s	Heat capacity rate of the supply air [W/K]
C_{max}	Maximum heat capacity rate of C_e and C_s [W/K]
C_{min}	Minimum heat capacity rate of C_e and C_s [W/K]
D_h	Hydraulic diameter [m]
$K_{lamella}$	Conductance in a lamella [W/K]
L	Characteristic length [m]
NTU	Number of transfer units [-]
Nu	Nusselt number [-]
P_w	Wetted perimeter [m]
Pr	Prandtl number [-]
\dot{Q}	The heat flux between two medium [W]
Re	Reynolds number [-]
SFP	Specific fan power [kW/(m ³ /s)]
T	Temperature [K]
U	Heat transfer coefficient [W/(m ² K)]
V	Velocity [m/s]
\dot{V}	Airflow [m ³ /s]
\dot{V}_e	Exhaust airflow [m ³ /s]
\dot{V}_{dim}	Largest airflow in the air handling unit [m ³ /s]
\dot{V}_s	Supply airflow [m ³ /s]
W_b	Emissive power [W/m ²]
ΣW_t	Sum of the electrical power for supply and exhaust fan [kW]

Roman lower case letters

c	Air speed [m/s]
$c_{p,e}$	Specific heat capacity of the exhaust air [J/(kg·K)]
$c_{p,s}$	Specific heat capacity of the supply air [J/(kg·K)]

$c_{p,min}$	Minimum specific heat capacity of the two airstreams [J/(kg·K)]
d	Thickness [m]
dT/dx	Thermal gradient [K/m]
f_{hours}	Scale factor [(h/year)/cm]
f_{temp}	Scale factor [°C/cm]
h	Convective heat transfer coefficient [W/m ² K], Hours [h]
k	Constant [Pa·s ² /m ⁶], Thermal conductivity [W/mK]
k_f	Thermal conductivity of fluid [W/mK]
\dot{m}_s	Mass flow of the supply air [kg/m ³]
\dot{m}_e	Mass flow of the exhaust air [kg/m ³]
\dot{m}_{min}	Minimum mass flow of the two airstreams [kg/m ³]
p_d	Dynamic pressure [Pa]
Δp	Pressure drop [Pa]
Δp_{tot}	Total pressure drop in the system [Pa]
q	Heat flow [W]
q_{max}	Maximum possible heat flow [W]
q''	Heat flux per unit area [W/m ²]
$t_{e,1}$	Temperature of the inlet media on the exhaust side [°C]
$t_{e,2}$	Temperature of the outlet media on the exhaust side [°C]
$t_{s,1}$	Temperature of the inlet media on the supply side [°C]
$t_{s,2}$	Temperature of the outlet media on the supply side [°C]
t_{year}	Annual mean temperature [°C]
Δt	Temperature difference [°C]
Δt_{ln}	Logarithmic mean temperature difference [°C]
Δt_m	Linear mean temperature difference [°C]
Δt_1	Temperature difference between the warmer airstreams inlet and the colder airstreams outlet [°C]
Δt_2	Temperature difference between the warmer airstreams outlet and the colder airstreams inlet [°C]

Greek lower case letters

α_c	Convective heat transfer coefficient [W/(m ² ·K)]
ε	Effectiveness [-]
η_{fan}	Total fan efficiency [-]
η_t	Thermal efficiency [-]

λ	Thermal conductivity [W/(m·K)]
μ	Dynamic viscosity [Pa·s]
ν	Kinematic viscosity [m ² /s]
ρ	Density of air [kg/m ³]
σ	Stefan Boltzmann constant 5.67×10^{-8} [W/(m ² ·K)]
τ	Operating time [h/year]

1 Introduction

The importance of constructing low-energy and passive houses has grown through the last decade. Since those houses have none or small heating systems, compared to regular residential houses, a considerable part of the total energy consumption is constituted by the energy to power the air handling unit in such houses. Therefore, there is a need for an effective and energy-saving HVAC-system in order to minimize the energy consumption in low-energy or passive houses. Most of the air leaving or entering a these houses is transported by fans and not by leakage through the building envelope. Since this air then must pass through an air handling unit, there is a great potential to recover energy of the outgoing air by means of integrating the air handling unit with a heat exchanger. The company REC Indovent, a designer of HVAC systems for low-energy and passive houses, wants to evaluate and improve the heat exchanger's thermal efficiency in their air handling unit Temovex 400 and they have asked if Chalmers can evaluate different solutions in a master thesis.

1.1 Purpose

The main purpose is to find suggestions of ways to improve the existing heat exchanger and use the learning outcomes to suggest future studies considering the design of heat exchangers. Another purpose is to give the authors a more practical point of view in the field of heat recovery.

1.2 Objective

The objective is to improve the thermal efficiency of an existing heat exchanger, provided by REC Indovent. Another outcome should be to improve the knowledge, for the readers of the report, in the field of effective heat exchangers.

1.3 Delimitations

This master thesis will focus on ways of improving the thermal efficiency of the heat exchanger, which is a part of an air handling unit. This should be done without creating unnecessary pressure drops, which will increase the energy demand for the fan. The pressure drop and thermal efficiency is related to the size of the airflow. Tests will therefore be carried out for two different airflows to simulate two different sizes of air handlings units, as REC Indovent provides several sizes of air handling units. REC Indovent will, for this master thesis, provide two types of air handling units. They differ in means of heat transfer area and test will be carried out on these two units. Furthermore, fans and air flowing through the air handling unit may cause noise, however, the effect of sound and vibrations will not be taken into account in this master thesis. The influence of condensation and freezing in the heat exchanger will not be considered due to limited possibilities to create conditions for condensation and freezing.

1.4 Method

Literature studies will be carried out in order to improve the knowledge in the field. Measurements on an existing air handling unit will be done and evaluated.

Measurements to be executed are: temperature, airflow and airspeed. In order to simulate two different sizes of air handling units, the experiments will be carried out for two different airflows. These experiments will be carried out on two different air handling units, one regular and one denser heat exchanger with a larger heat transfer area. Possible ways of improve the air handling units will be suggested after an experimental evaluation.

2 Theory

A large number of parameters decide the properties of a heat exchanger. To be able to improve the heat transfer rate in a heat exchanger there is a need to fully understand the underlying mechanisms of heat transfer and how they influence the design of heat exchangers. The following chapter presents theoretical knowledge such as the fundamentals of heat transfer, theory behind heat exchangers, the efficiencies related to heat exchangers, the NTU-method and basic knowledge about specific fan power. All experiments in Chapter 3 will be carried out based on this theory.

2.1 Heat transfer

Heat transfer is a process in which energy is transported by convection, conduction or radiation. A temperature gradient is needed to transfer heat. Basic heat transfer theory is essential in our study to make it clear how energy is transferred through a heat exchanger in order to investigate possible improvements.

2.1.1 Convection

Energy transported by air movements is known as convection and usually occur between fluids and surfaces. Initially, convection may be divided into two groups; natural and forced convection. Natural convection is caused by temperature differences, which lead to air movements since the air density varies with temperature. These air movements are, however, not of significant size compared to forced convection, where a fan may create a large air speed. The heat transfer rate increases with a greater air speed, why forced convection is preferable when large heat transfer is requested. Furthermore, the airflow can be categorized as laminar or turbulent, where a turbulent flow transfers more heat than laminar flow. Whether airflow is turbulent or laminar is determined by Reynolds number, which is a dimensionless ratio between inertia and viscous forces.

$$Re_L = \frac{VL}{\nu} \quad (2.1)$$

The critical Reynolds number for a turbulent flow between two surfaces is approximately 1100 (Abel, Jagemar & Widén, 1997). A lower value implies a laminar flow, whereas a larger value represents a turbulent flow. In case of flow in a pipe or duct the characteristic length L is named the hydraulic diameter D_h and calculated as

$$D_h = \frac{4A}{P_w} \quad (2.2)$$

However, in order to know the magnitude of the heat flux due to convection, the convective heat transfer coefficient, α_c , has to be determined. When considering a heat exchanger the convective heat transfer coefficient is of interest since it is related to the U-value and the actual heat transfer rate through the exchanger. The coefficient depends on a wide range of parameters such as; the fluids properties, speed and the surface geometrical layout to mention some. Determination of the convective heat transfer coefficient can either be theoretical or practical. Theoretically it can be determined by calculating the Nusselt number for the specific case. It is defined as the relation between the convective and conductive heat transfer coefficients, as

$$Nu = \frac{hD_h}{k_f} \quad (2.3)$$

As the definition shows, a large Nusselt number indicates a high convective heat flow and a turbulent airflow. When the heat transfer through convection and conduction are closer to be equal, i.e. a lower Nusselt number, the flow is of laminar nature. The Nusselt number is dimensionless and, when considering forced convection, a function of Reynolds and Prandtl number. Exactly how the Nusselt number is described in these dimensionless parameters is a matter of the surface and fluid properties. For instance, what fluid that is issued and how the surface is designed in terms of corrugation and channel dimensions etcetera. Therefore, the equations for Nusselt number may differ dependent on what case that is in question and are derived experimentally from case to case. The Reynolds number is previously mentioned and the Prandtl number is defined as the ratio between momentum and thermal diffusivity.

$$Pr = \frac{\mu c_p}{k} \quad (2.4)$$

In contrast to Reynolds and Nusselts number, the Prandtl number is not a function of any length variable and is hence only a property of the fluid and its state. It can for this reason be found in property tables for a specific fluid.

2.1.2 Conduction

Heat transferred from atom to atom by collisions and vibrations, without a net mass flow, is named conduction. Conduction is the main way to transport heat in solid material since it is not possible for convection or radiation to take place there. The magnitude of the heat flux can be described by Fourier's law for a one-dimensional case

$$q'' = -\lambda \frac{dT}{dx} \quad (2.5)$$

The heat flows towards the region with lower temperature, shown by the minus sign in equation (2.5). Considering an air to air heat exchanger, thermal conduction appear through the lamellas from the hot air side to the cold air side. Due to the forced and turbulent airflow no conduction is assumed to appear in the air stream.

2.1.3 Radiation

Energy may, in contrast to convection and conduction, also be transported without connection to a material, as thermal radiation. Energy is released from a surface and received by another and the magnitude of the heat flux is dependent on the temperature and the properties of the surfaces. The largest amount heat that can be emitted from a surface is according to Stefan-Boltzmanns law

$$W_b = \sigma T^4 \quad (2.6)$$

Such surface is called a blackbody and its properties are ideal, which does not exist in reality. However, thermal radiation is not of significant size in air to air heat exchangers as the radiation energy is transported from surface to surface and not from surface to air.

2.2 Efficiencies

To measure and grade a heat exchanger there is a need for describing how much energy that can be recovered. This report will handle three types of defining how well a heat exchanger is working; thermal efficiency, effectiveness and energy efficiency.

2.2.1 Thermal efficiency

The thermal efficiency is a measurement of how much heat that can be recovered in a specific moment. It varies between different heat exchangers and is because of that reason a measurement of how efficient the exchanger is. Thermal efficiency is defined as the obtained temperature lift divided to the maximum temperature lift that could possible occur. As two airflows runs through the heat exchanger, two thermal efficiencies may be calculated. One on supply and one on exhaust side. In this report the thermal efficiency on the supply side is used which is defined as

$$\eta_t = \frac{t_{s,2} - t_{s,1}}{t_{e,1} - t_{s,1}} \quad (2.7)$$

The temperatures used to determine the thermal efficiency are measured in connection to the heat exchanger according to Figure 2.1.

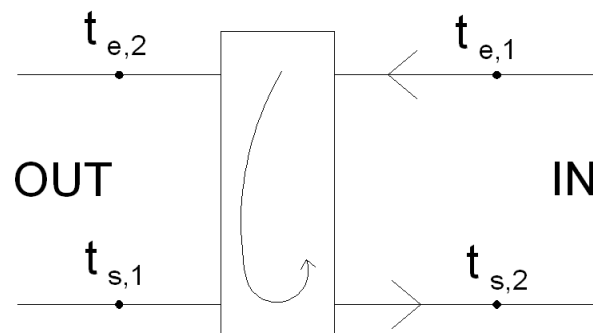

Figure 2.1 Temperatures before and after a heat exchanger on supply and exhaust side of ventilation system.

What influences the thermal efficiency is the relation between supply and exhaust flow through the heat exchanger. For instance, a larger exhaust than supply flow will increase the thermal efficiency at the supply side, whereas it will be decreased at the exhaust side. A larger airflow transports a greater amount of energy, why the temperature lift becomes greater at the supply side with larger exhaust flow than supply flow. The inlet temperatures might be the same but the thermal efficiency still changes if the airflows are of different sizes.

Another aspect is that unequal airflows will increase the energy consumption for the whole building. For instance, a larger flow on the supply side means that the exhaust air will not be able to heat the supply air to the desired level, which increases the load on the heater leading to unnecessary energy consumption. The energy consumption might increase if the exhaust flow is the largest one, since the resulting underpressure in the building leads to infiltration of outdoor air into the building. This infiltrated air will be heated by other sources than the air handling unit. This is more closely described in Section 3.5

What also affects the thermal efficiency is an uneven distribution of the airflow through the heat exchanger. In a plate heat exchanger the air flows in channels, every second exhaust air and every other supply air, and in order to optimize the thermal efficiency the flow in each channel needs to correspond to the flow in the neighbouring channel. The supply airflow may be just as large as the exhaust flow but if the two flows are not distributed in the same manner, through the heat exchanger, the thermal efficiency is decreased.

2.2.2 Effectiveness

Effectiveness is another way of describing how much energy that has been recovered in a heat exchanger. It is especially used in connection with the NTU-method, presented in Section 2.5. It is determined by the actual energy change in one airflow divided by the greatest energy change that could take place. It is defined as

$$\varepsilon = \frac{\dot{Q}}{\dot{Q}_{max}} \quad (2.8)$$

The heat gained or lost in the supply air stream through the heat exchanger is defined as:

$$\dot{Q} = \dot{m}_s c_{p,s} (t_{s,2} - t_{s,1}) \quad (2.9)$$

or equally for the exhaust air stream

$$\dot{Q} = \dot{m}_e c_{p,e} (t_{e,1} - t_{e,2}) \quad (2.10)$$

and the maximum heat transfer in equation (2.8) is defined as

$$\dot{Q}_{max} = (\dot{m}c_p)_{min} (t_{e,1} - t_{s,1}) \quad (2.11)$$

It may be observed that when $\dot{m}_s c_{p,s} = \dot{m}_e c_{p,e}$ equation (2.8) results in a division between two temperature differences. Hence, the effectiveness is equal to the thermal efficiency on condition that the two mass flows and specific heat capacities are of equal sizes.

2.2.3 Energy efficiency

The energy efficiency describes how much energy that is recovered by the heat exchanger in relation to the total heating demand for the air handling unit during a year.

$$\eta_e = \frac{Q_{hx}}{Q_{tot}} \quad (2.12)$$

The heat recovered by the exchanger is related to its thermal efficiency and a higher thermal efficiency will result in a better energy efficiency. However, the energy efficiency has an upper limit of 100%, since the thermal efficiency is at most 100%. Another variable that affects the energy efficiency is the inlet temperature of the air from the air handling unit. A lower inlet temperature results in a better energy efficiency since the total energy demand is decreased, provided that the thermal efficiency of the heat exchanger is constant. There is an outdoor condition where the

thermal efficiency is good enough to lift the outdoor air temperature to the required inlet temperature and at warmer conditions the thermal efficiency has to be decreased, in order not to get a too high inlet temperature. The thermal efficiency can be lowered either by decreasing the rotational speed, in case of a rotary heat exchanger, or by bypassing air, if a plate heat exchanger is in question. With a lower inlet temperature is the total time increased when the thermal efficiency of the heat exchanger is deliberately reduced. As a result, the energy efficiency is increased even though the thermal efficiency is decreased during longer periods of time. The energy efficiency and the parameters it depends on may be illustrated graphically in a duration diagram.

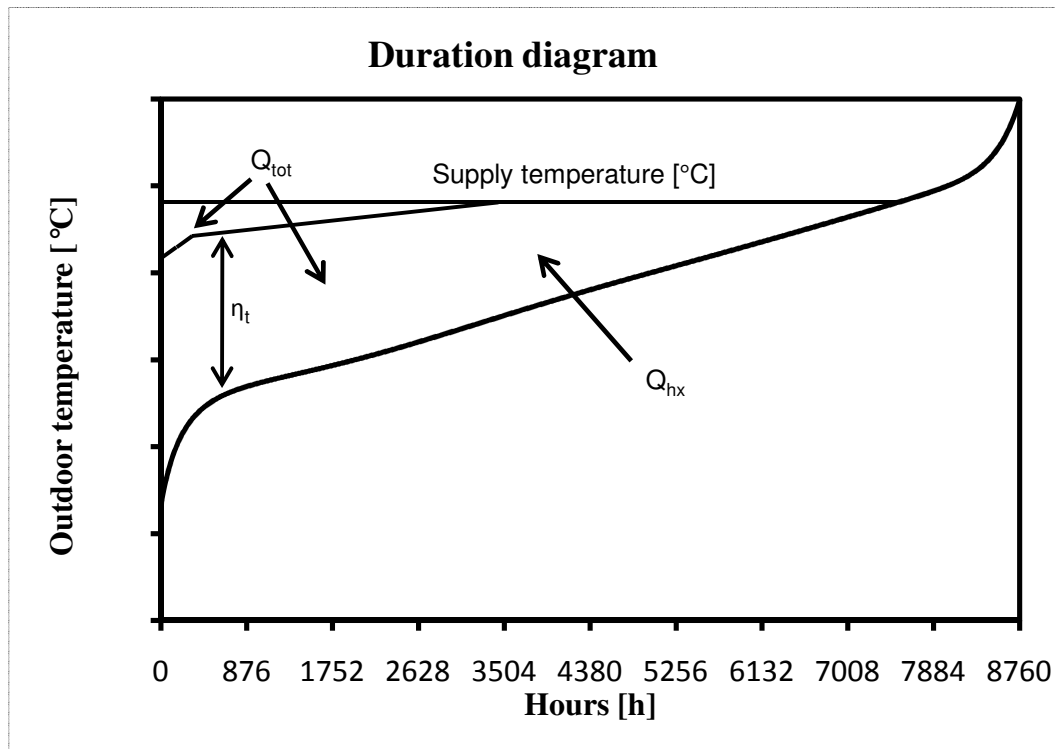

Figure 2.2 Duration diagram with total energy demand, Q_{tot} , and energy recovered, Q_{hx} .

Figure 2.2 shows a duration diagram where the area enclosed by the inlet temperature, t_{in} , and the duration line is the total energy demand, Q_{tot} . Dependent on the thermal efficiency, η_t , the area of the energy supplied by the heat exchanger is altered and hence the energy efficiency, according to equation (2.12).

2.3 Heat exchanger

In order to be able to reduce the energy losses through a ventilation system there is a need to recover energy from air leaving the building. An air to air heat exchanger does this by means of transferring energy between two air channels. Energy can be transferred either as sensible or latent heat. The latent heat is transferred by the air as moisture solved in the air and is transformed into sensible energy when the moisture condenses in the airstream. Consequently, in order to transfer latent heat by air some air leakages between the two airstreams are required. However, if the condensation

takes place in the airstream that releases energy to the other, some part of this latent heat will be transferred as sensible heat.

Depending on type, geometry and material, the heat exchangers properties vary considering thermal efficiency and pressure drop over the unit. This report will not treat every heat exchanger in detail. Experiments will be carried out on a counter flow plate heat exchanger and therefore the focus in the following section will be on plate heat exchangers. Nevertheless, the rotary heat exchanger and some fixed plate heat exchangers besides the counter flow heat exchanger will be described briefly to give the reader a better background of the benefits and drawbacks of different types of heat exchangers.

Independent of what type of heat exchanger that is in question, temperature differences must be present as the heat exchangers function is to transfer heat. Therefore are different temperature differences, needed for calculations, presented in this section.

2.3.1 Logarithmic mean temperature difference

In order to get a heat flux through the heat exchanger there must be a temperature difference between the two airflows running through it. To be able to determine this heat flux the temperature difference has to be known. A trivial solution is just to use the inlet and outlet temperatures according to

$$\Delta t_m = \frac{\Delta t_2 + \Delta t_1}{2} \quad (2.13)$$

However, the logarithmic mean temperature difference is preferably used when the temperature difference varies within the exchanger. It provides an average temperature difference that reflects the difference more accurate compared to what a regular mean temperature difference does. To determine the logarithmic mean temperature difference, inlet and outlet temperatures of the fluid have to be known for both sides of the heat exchanger. It is defined as (Abel & Elmroth, 2007, p.233).

$$\Delta t_{ln} = \frac{\Delta t_2 - \Delta t_1}{\ln \frac{\Delta t_2}{\Delta t_1}} \quad (2.14)$$

The temperature differences, Δt_1 and Δt_2 , in equation (2.14) are equal to the difference in temperature between the two airflows at the same side of the heat exchanger. In the special case when these two differences are equal to each other is the logarithmic mean temperature difference not valid, since the denominator equals zero. Then is the difference calculated according to equation (2.7).

The temperature distributions for both supply and exhaust air streams, for a counter flow heat exchanger, can be shown principally in a diagram. While the air flows through the heat exchanger, it is either heated or cooled. As the heat exchanger in this master thesis is of counter flow type the temperature distribution may look as Figure 2.3.

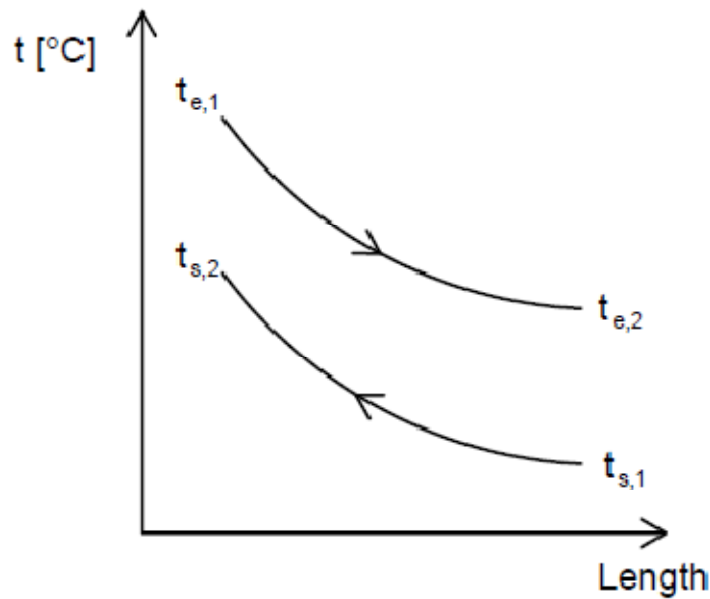

Figure 2.3 Temperature distribution through counter flow heat exchanger.

When determining the properties of the heat exchangers it is of great help to know the logarithmic mean temperature difference in order to determine the heat flow in the heat exchanger, thus

$$\dot{Q} = UA\Delta t_{ln} \quad (2.15)$$

2.3.2 Rotary heat exchanger

The rotary heat exchanger consists of a rotor connected to a cylinder with a large number of small holes piercing it, allowing air to pass through. It is revolving between two airstreams, letting heat or heat and moisture be recovered from one airstream to another. The cylinder is heated by the warm air and then it rotates into the cold airstream where it releases energy.

In rotary heat exchangers there is always some leakage between the airstreams due to pressure differences in the channels. It can be positive to recover some of the indoor humidity this way but the drawback of this is that it is difficult to control the air leakage and prevent contaminants passing from the exhaust air to the clean supply air. When handling large air quantities, this leakage can in some cases be neglected when the volume of contaminated air is small compared to the total air volume.

In constructions with high demands of air quality, for instance a surgery ward, a rotary heat exchanger might not be the proper choice. However, in other cases it might be a good choice since the rotary heat exchanger works in counterflow mode and transports air through narrow channels, which results in a high effectiveness amongst heat exchangers (ASHRAE, 2004, p. 44.10). Generally it exceeds 85% (Shah & Sekulić, 2003, p.51).

2.3.3 Fixed plate heat exchanger

The fixed plate heat exchanger is an effective energy recovery unit of sensible heat that can meet high demand of air quality since the air leakage of a plate heat exchanger is in many cases negligible. The heat is transferred by convection and

conduction. The unit is made of several lamellas creating air channels where the two airstreams are overlapping each other in order to transfer heat. There are three types of air configurations of fixed plate heat exchangers; parallel, cross flow and counter flow heat exchanger.

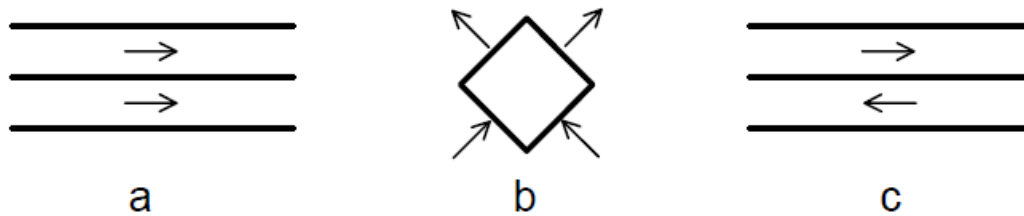

Figure 2.4 Three different types of plate heat exchangers; parallel flow (a), cross flow (b) and counter flow (c).

In the parallel heat exchanger both airstreams enters the heat exchanger on the same side. This means that if the mass flows are equal, the outlet temperature of the two airstreams, in an infinite parallel heat exchanger, will both reach the mean temperature between the two inlet temperatures. Consequently, the effectiveness will never exceed 50% theoretically.

The cross flow heat exchanger is arranged so that the two airstreams enters the heat exchanger perpendicular to each other. This type of airflow arrangement will increase the effectiveness further, but generally not above 75% (ASHRAE, 2004, p. 44.10). However, the cross flow heat exchanger is a relatively small unit with adequate efficiency that is commonly used. Sometimes more than one cross flow heat exchanger is installed in a row, letting the warm air pass the cold air more than once. This type is called a multiple-pass heat exchanger and will increase the effectiveness to 60%-85% (ASHRAE, 2004, p. 44.10).

The heat exchanger with the highest theoretical thermal efficiency is the counter flow heat exchanger which is designed so that the outlet of the colder air meets the inlet of the warmer air, allowing maximum exchange of energy between the two airstreams. This arrangement provides the highest theoretical value of effectiveness amongst the three heat exchangers, up to 100% (ASHRAE, 2004, p. 44.10).

Since the heat transfer rate is not only dependent of the logarithmic mean temperature, but also the U-value and the specific area, it is of interest to investigate how to optimize these factors in the design of a heat exchanger. The specific area describes how large area that connects one media to another. Increasing the specific area requires an increase in size of the heat exchanger, either by increasing the length or the quantity of lamellas. In order to improve the U-value a number of modifications can be carried out. As mentioned earlier, the heat is transferred by convection and conduction. Changing material or altering the thickness of the plates will change the conductive resistance. Changing the boundaries for the flow such as altering the pattern of the plate's surfaces or varying the height of the channels in between the plates will both induce a new convective heat transfer coefficient. The distance between the lamellas is usually varying between 2.5 mm to 12.5 mm according to ASHRAE (2004, p. 44.9). A high heat transfer rate is connected to small distance between the lamellas but the drawback is then a greater pressure drop over the heat exchanger. The flow should also be turbulent which is usually created by printing a pattern on the plate's surface, preventing the flow from becoming laminar.

2.3.4 Condensation in heat exchanger

Condensation occurs when humid air comes in contact with a surface that is colder than the air's dew point. This is most likely to occur in the winter when the indoor air is warm and humid in contrast to the cold and dry outdoor air. When the temperature of the condensate is below zero degrees Celsius, freezing might occur. The ice particles will increase the flow resistance through the heat exchanger, causing the pressure drop to increase. Freezing can also lead to severe damage as water expands when forming ice. A high-efficient heat exchanger is more at risk for creating conditions favourable for ice accumulation since the warm and humid exhaust air will release more heat to the colder supply airstream, increasing the possibility for the exhaust air to reach temperatures below zero degrees Celsius.

Condensation can also be beneficial in plate heat exchangers. When condensation occurs, latent heat is released at the condensation area and transferred by conduction and convection to the inlet airstream. Although the condensation increases the heat transfer, it must then be removed from the system in order to prevent unnecessary pressure drops and freezing damages. There should be a clear approach of how to deal with the accumulating condensation. For instance a drainage system for the condensate can be installed.

2.4 Thermal efficiency and effectiveness dependent on outdoor temperature

A heat exchanger's thermal efficiency is dependent on the ambient conditions. Differences in temperature might result in differences in thermal efficiencies.

The outdoor temperature is varying during a year and hence the inlet temperature into the heat exchanger. As the density of the air varies with the temperature, the inlet air has different density over the year or from hour to hour. In addition, the air density also changes with different relative humidity. The relative humidity does not, however, influence the density as much as the temperature does, especially not at lower temperatures, for instance below zero degrees Celsius, as the air cannot contain that much humidity at such conditions. The following table shows the air density at different temperatures (Hagentoft, 2001, p. 408).

Table 2.1 The air density varies with the temperature. The air density is in this table based on a relative humidity of 50%.

Temperature [°C]	Air density [kg/m ³]
-20	1.395
-10	1.341
0	1.291
10	1.244
20	1.198

The heat capacity rates for the supply and exhaust airflows are calculated as

$$C_s = \dot{m}_s c_{p,s} \quad (2.16)$$

$$C_e = \dot{m}_e c_{p,e} \quad (2.17)$$

The massflows are depending on the density and airflow. As a result, the heat capacity rate varies at the supply side, whereas it is approximately constant at the exhaust side, on condition the air volume flows are constant. Consequently, the heat capacity rate at the supply side increases with colder temperatures provided the air volume flow is constant.

A greater heat capacity rate at the supply side in the heat exchanger needs more energy in order to raise the temperature one degree Celsius. The heat is transferred from the exhaust airflow, where the heat capacity rate is constant. Therefore, the thermal efficiency is decreased when the outdoor temperature decreases. How the heat capacity rates vary due to density changes of the air may be described by a ratio between them. If plotted in a diagram it looks as the following diagram.

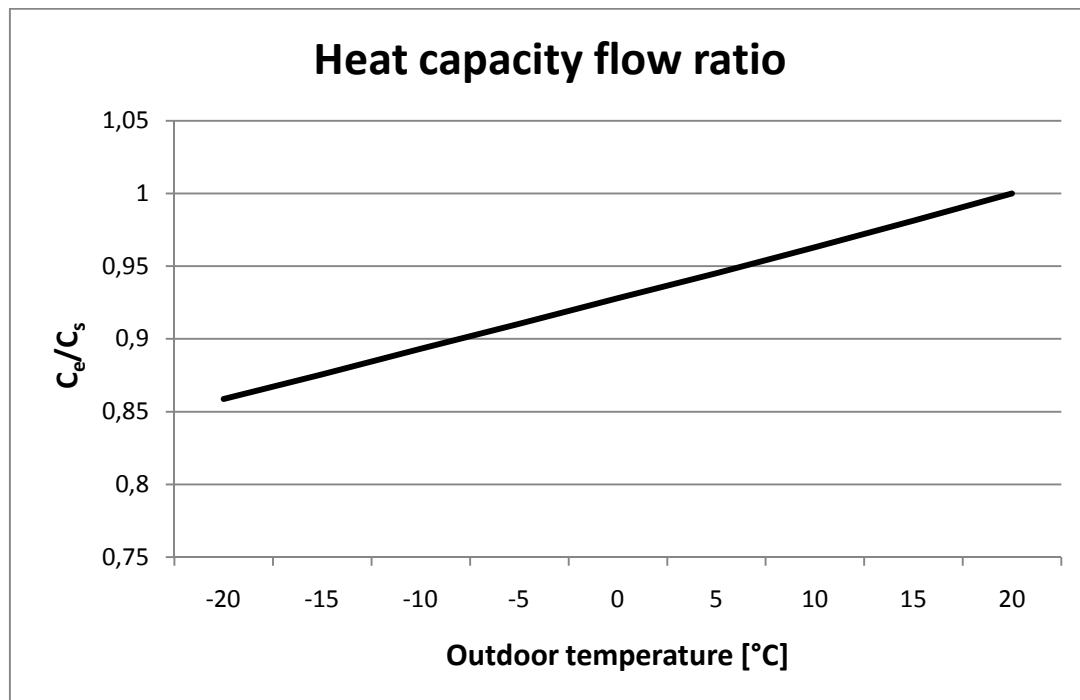

Figure 2.5 Different temperatures results in a heat capacity flow ratio that changes. As the air volume flows and specific heat capacities are identical for both flows, the heat capacity flow ratio ends up in a ratio between the densities. The air densities of the inlet conditions are used in this figure.

Insertion of equation (2.7), (2.9), (2.11), (2.16) and (2.17) into (2.8) gives an equation where the effectiveness depends on the heat capacity rate ratio and the thermal efficiency.

$$\eta_t = \frac{C_e}{C_s} \varepsilon \quad (2.18)$$

From this equation and Figure 2.5 it may be concluded that the thermal efficiency deviates more from the effectiveness the colder the outdoor temperature is.

2.5 NTU method

The NTU-method or the Number of Transfer Units method is an approximation method used for estimating the effectiveness of a heat exchanger when the logarithmic mean temperature is comprehensive or impractical to calculate (Incropera, DeWitt, Bergman and Lavine 2007, p. 686). It was developed by W. M. Kays and A. L. London. Principally this method is based on two equations involving the properties of the medias, the heat transfer coefficients and the specific heat transfer area. The effectiveness is a function of NTU and the quota between the smaller and the larger heat capacity rate.

$$\varepsilon = f\left(NTU, \frac{C_{min}}{C_{max}}\right) \quad (2.19)$$

$$NTU = \frac{UA_s}{C_{min}} \quad (2.20)$$

The effectiveness correlation with the NTU factor depends of the design of the heat exchanger. Each type of heat exchanger has its own tabulated values. For a counter flow heat exchanger with plain surfaces the effectiveness can be calculated according to equation (2.21) (Shah & Sekulić, 2003, p.124). For equal flows equation (2.22) can be used.

$$\varepsilon = \frac{1 - \exp[-NTU(1 - \frac{C_{min}}{C_{max}})]}{1 - \frac{C_{min}}{C_{max}} \exp[-NTU(1 - \frac{C_{min}}{C_{max}})]} \quad (2.21)$$

$$\varepsilon = \frac{NTU}{NTU + 1} \quad (2.22)$$

Figure 2.6 shows how the effectiveness varies with varying flows in a counter flow heat exchanger, when keeping the UA-value constant. The effectiveness is calculated according to equation (2.21) and (2.22). As Section 2.4 concluded the thermal efficiency varies with outdoor temperature. Figure 2.6 shows that the effectiveness is also depending on the temperature since a decreased outdoor temperature causes the specific heat rate ratio to increase and consequently the supply effectiveness decreases.

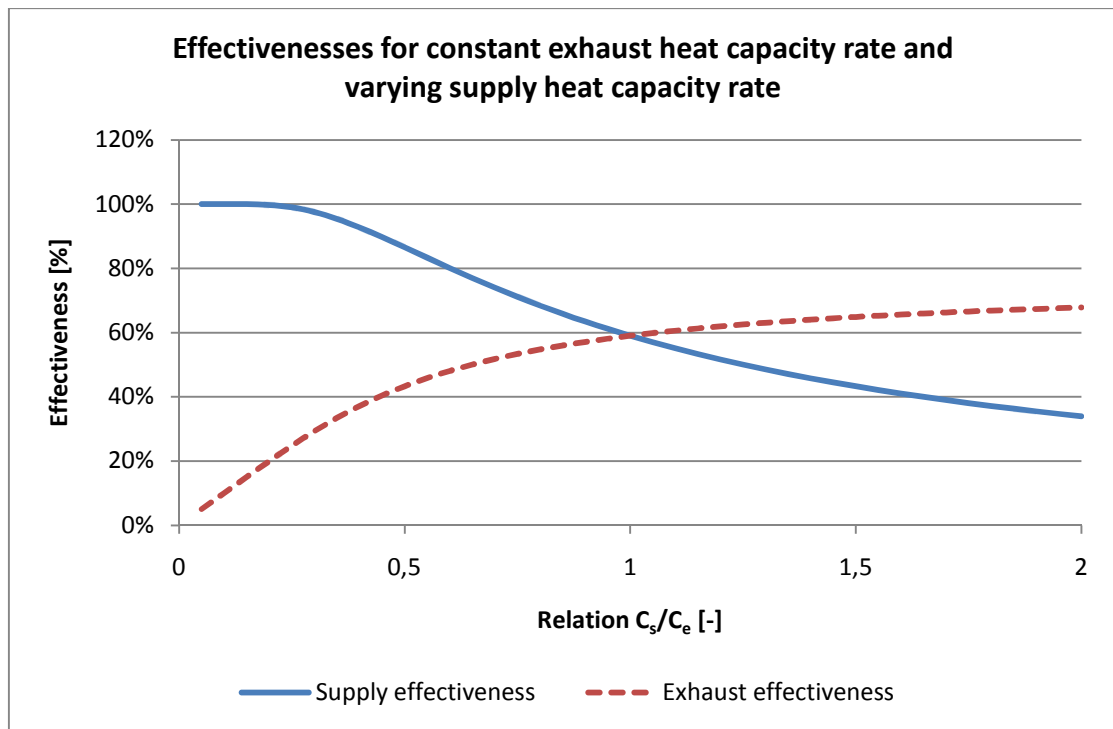

Figure 2.6 The effectiveness for a counter flow heat exchanger varies with the airflows as seen above. In this example the airflow represents one single channel in the heat exchanger with a constant UA-value.

2.6 U-value

The U-value is a figure that reveals a constructions heat transfer properties. An U-value for a material is calculated according to the equation

$$U = \frac{\lambda}{d} \quad (2.23)$$

Applied on a plate heat exchanger as in our unit is the U-value depending on both the conductive and the convective heat transfer coefficients. The two airstreams are separated by the surface heat transfer resistance and the thermal resistance in the lamella as seen in Figure 2.7. This network can be reduced to one U-value according to equation (2.24).

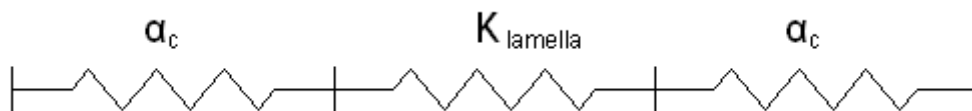

Figure 2.7. Heat transfer through a lamella with surface resistance on two sides. The more turbulent flow, the higher it gets which results in a lower surface resistance.

$$U = \frac{1}{\frac{1}{\alpha_c} + \frac{1}{U_{lamella}} + \frac{1}{\alpha_c}} \quad (2.24)$$

In order to calculate an accurate NTU-value, the correct U-value for one lamella must be determined. Consequently, to calculate a correct effectiveness one need to know the convective heat transfer coefficients, the thermal properties of the lamellas and the heat capacity rates. Since air movements are relatively difficult to predict, the heat transfer coefficient and U-value is usually determined through experiments.

2.7 Specific fan power

A way to describe how much electrical energy that is consumed by the fan in relation to the airflow passing is by the specific fan power, SFP. A low SFP value is the effect of an energy efficient ventilation system. According to the Swedish National Board of Housing, Building and Planning (Boverket), the SFP value is advised to be kept lower than 2.0 kW/(m³/s), when considering a system with both supply and exhaust ventilation (Boverket 2011). The SFP value for a system with supply and exhaust fans is calculated as

$$SFP = \frac{\Sigma \dot{W}_t}{\dot{V}_{dim}} \quad (2.25)$$

2.7.1 Fan

Another important part of the air handling unit is the fan, which function is to pressurize the system. As a result, a pressure difference occur which is the driving force for an airflow. To reach a low SFP value it is important to have fans whose energy consumption is low. To achieve this it is essential that the fan has a sufficient efficiency and the pressure drop over the duct system is low, in order to meet the demands. The electrical energy used by a fan may be calculated as

$$\dot{W}_t = \frac{1}{\eta_{fan}} \Delta p_{tot} \dot{V} \quad (2.26)$$

2.7.2 Air pressure in ductworks

Air that flows in a duct has a total pressure that is the sum of the static and dynamic pressure. The dynamic pressure is a matter of the airspeed and density of the air

$$p_d = \frac{\rho c^2}{2} \quad (2.27)$$

However, the dynamic pressure constitutes a small part of the total pressure, why it is often ignored. The static pressure is of greater magnitude and the static pressure drop has to be determined for a specific duct system, in order to choose an appropriate fan. How large the static fan pressure is, that has to be created by the fan, is a matter of how large the airflow is together with the design and layout of the ductworks. Due to

friction between the air and the duct the airflow continuously lose pressure. In case of a turbulent flow the relation between static pressure drop and air volume flow is

$$\Delta p = k\dot{V}^2 \quad (2.28)$$

In addition to the pressure drop in the ductworks, all units such as heaters, coolers, humidifiers, filters and heat exchangers constitute single pressure drops.

3 Experiments

The next chapter will present how a number of tests of the air handling unit have been carried out. Experiment to ensure the trustworthiness of the result will be described, followed by tests of determining the properties of the air handling unit. Then the results have been evaluated and further tests have been done to improve the thermal efficiency of the heat exchanger.

3.1 Materials

The following section will introduce the equipment necessary to carry out the experiments. The different measuring equipment will be presented, followed by a description of the air handling unit and how the test site is assembled.

3.1.1 Measuring equipment

When measuring the thermal efficiency the temperature meters are the most important equipment. The tests have been carried out using temperature meters which has been inserted in the middle of the duct. Some tests have been carried out to ensure the reliability of the results and determine the magnitude of potential error sources. The deviation amongst these temperature meters is investigated by performing an ice water test, described in Section 3.2.2, where also a reference meter, Dostmann P650, was used to verify the reliability of the results. To ensure that the temperature meters measures the actual mean temperature of the air in the duct system, the temperature distribution of the air in the ducts have been monitored. This experiment is carried out by using a SwemaAir 300 attached to an integrated velocity and temperature meter.

However, in order to ensure that the results can be compared between each other, the flow on the supply and the exhaust side needs to be monitored. This has been done by measuring the differential pressure with a SwemaAir 300 attached to a differential pressure meter.

One way of determining the SFP is to measure the air handling unit's power consumption. To do this, an Esic PM498 has been used. A complete list of the measuring equipment and their accuracies is presented in Table 3.1.

Table 3.1 Measuring equipment and their properties. The properties are taken from each products manual except from the uncertainty of the temperature meters which are measured in Section 3.2.2.

Equipment	Measures	Accuracy
Temperature meters	<i>Temperature</i>	± 0.2 °C (measured)
Dostmann P650	<i>Temperature</i>	± 0.1 °C
SwemaAir 300	<i>Temperature</i>	± 0.4 °C
	<i>Velocity</i>	$\pm 3\%$, minimum 0.03 m/s
	<i>Pressure</i>	$\pm 3\%$ from measured Pa
Esic PM498	<i>Power</i>	$\pm 3\%$, minimum ± 2 W

3.1.2 Air handling unit and ductwork

The tests have been carried out on two different heat exchangers. They are both components of an air handling unit. These air handling units will be denoted as AHU 1 and AHU 2. Besides the heat exchanger, the air handling unit consists of a supply and exhaust fan, two filters, a 0.9 kW heater and a control panel with a regulating system inside. The dimensions of the unit are illustrated in Figure 3.1, which represents AHU 1. The figure also shows that all ducts are attached at the top of the unit. Behind the heat exchanger, in the back of the air handling unit, two transporting channels run. One of them transports the outdoor air to the bottom of the unit where it enters the heat exchanger. After the heat exchanger the air is passing through the fan and the heater before it leaves the unit into the supply duct system.

In contrast to the supply fan, the exhaust fan is placed before the heat exchanger. As a result, the exhaust fan is blowing the exhaust air into the heat exchanger while the supply fan is creating an underpressure that will force the supply air through the heat exchanger. The exhaust air is then leaving the heat exchanger at the bottom of the unit and is directed away from the unit after being transported in the other transporting channel. In other words, the exhaust air transported through the air handling unit in the opposite way as the supply air. AHU 2 works in the same way as AHU 1 but is a mirror image of AHU 1 and is not drawn in the following figure.

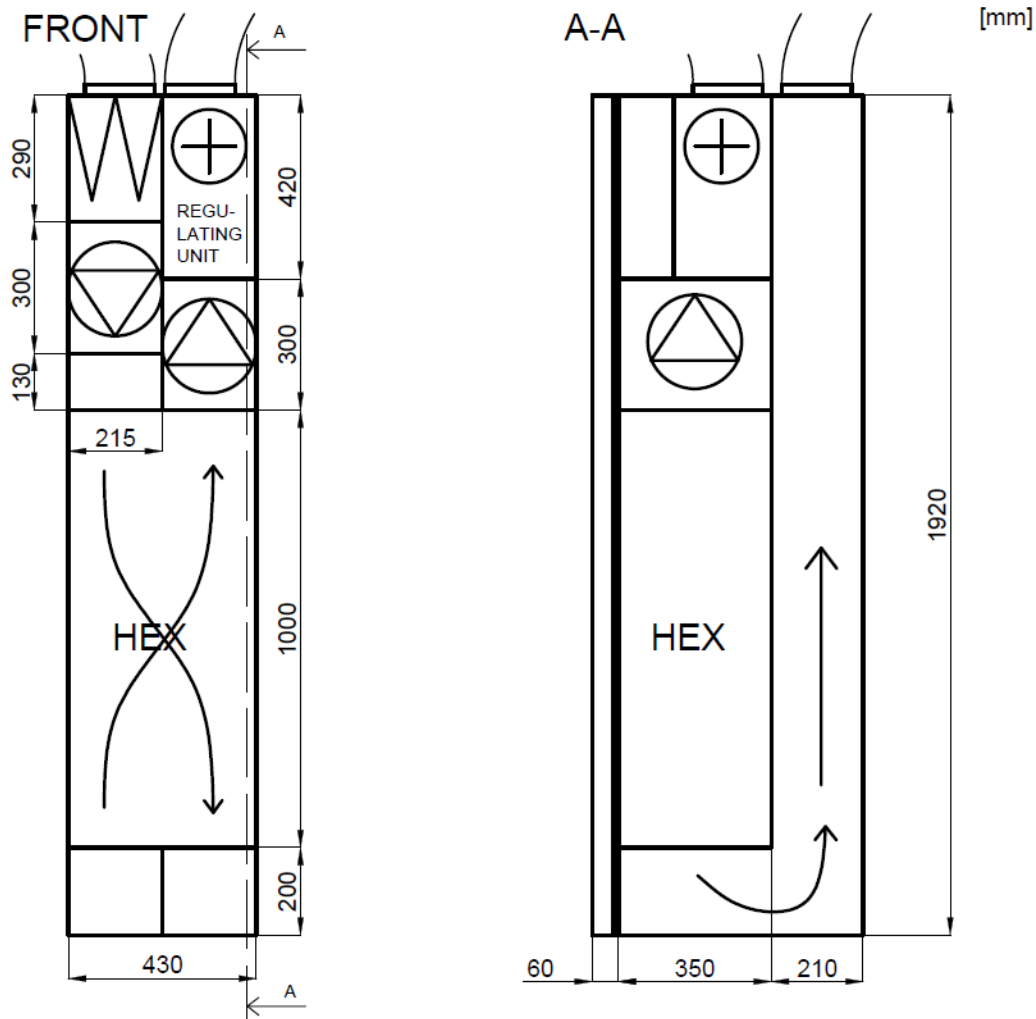

Figure 3.1 Air handling unit seen from front and right side. The fan directed downwards is the exhaust fan. The rectangle on the left in the right hand picture represents the door. All the ductwork are attached to the connection on the top of the unit. AHU 2 is mirrored with the exhaust fan located to the right of the unit.

3.1.2.1 Heat exchanger

The heat exchanger in AHU 1 is a counter flow plate heat exchanger made of 66 corrugated aluminium sheets put together with a distance of four millimetres between each sheet. In every other channel supply air runs and every other exhaust air runs, hence 33 channels in each direction. The aluminium sheet has dimensions according to Figure 3.2 and a thickness of about 1 millimetre. This design results in a total heat transfer area of 45 m².

AHU 2 consists of a more compact counter flow heat exchanger with an increased number of lamellas. The total number of aluminium sheets has been increased by 40%, which gives a heat transfer area of about 61.4 m². Otherwise the heat exchanger in AHU 2 is identical to the one located in AHU 1.

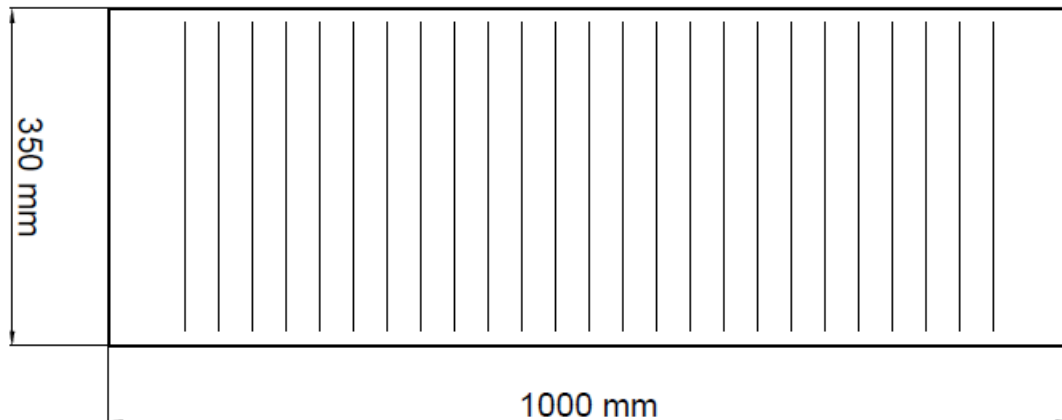

Figure 3.2 Dimensions of one aluminum lamella. The lamella is placed vertically inside the heat exchanger.

The corrugation is horizontally orientated which means that the airflows perpendicular to the corrugation. The corrugation is made to ensure turbulent airflow and thus a greater heat transfer. The profile of the corrugated lamella is according to Figure 3.3 with a wavelength of 35 millimeters and an amplitude of 2.25 millimeters.

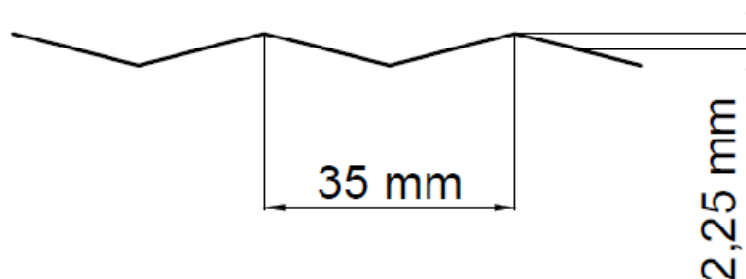

Figure 3.3 The corrugation design of the aluminum lamella.

3.1.3 Setup of test site

The test sites for both AHU1 and AHU2 are assembled in the same manner. They are placed on a mezzanine floor in a lab building. Attached to the top of the units is all the ductwork. The outdoor air runs along a four meter long duct, the supply air is directed to the ground floor through a 25 meter long duct, the room air is taken from the roof through a one meter long duct and the exhaust air is directed out of the building through a 25 meter long duct. The temperature meters are placed in a drilled hole in every channel approximately one meter from the air handling units. In order to measure the flow in the ducts a hole was drilled, allowing a differential pressure meter to be inserted. The flow is measured at both exhaust and supply side of the duct system. Since the risk for condensation in the heat exchanger is negligible for the conditions in the experiments, the drainage pipe for condensation water is blocked so that the measured flow in the ducts represents the actual flow through the heat exchanger. A principal scheme of the test site and how the different meters are placed is presented in Figure 3.4.

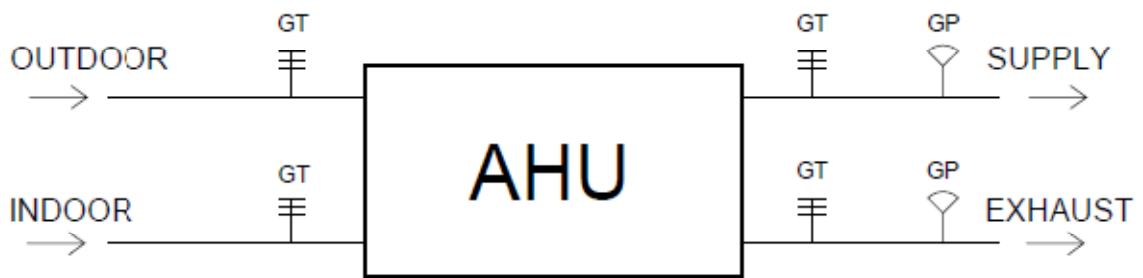

Figure 3.4 Principal scheme of the air handling unit and meters used for the tests.

Since the temperatures are measured before and after the fans in the air handling unit the fans will affect the thermal efficiency of both supply and exhaust side. As shown in Section 3.1.2 the supply fan is located right after the heat exchanger, increasing the supply temperature further before reaching the temperature meter, leading to an increased supply thermal efficiency. The exhaust fan is located before the heat exchanger increasing the temperature of the exhaust air before entering it, which means that some of the exhaust fan energy is recovered in the heat exchanger. However, the room temperature is measured before the fan and consequently the air entering the heat exchanger is slightly higher than the measured. Figure 3.5 illustrates how the temperature varies over the air handling unit in between the temperature sensors. Before the supply air reaches the temperature sensor it will also exchange some heat with the surrounding depending on the temperature difference between supply air and room temperature. These facts will cause the thermal efficiency on the supply side to be raised and lowered on the exhaust side. The supply thermal efficiency will increase at a higher rate than the exhaust thermal efficiency will decrease since some of the heat generated by the exhaust fan will be recovered in the heat exchanger. How the thermal efficiencies depend on the temperature lift over the fans are illustrated in Figure 3.6.

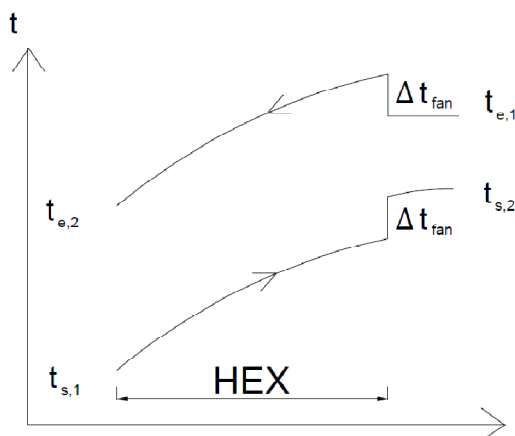

Figure 3.5 Influence of fan for the temperatures of air leaving and entering the heat exchanger. The supply air is heated even further after the fan if the ambient air is warmer than the supply air. The inlet of the exhaust air is the same as the room temperature and therefore the temperature of the air before the fan is constant.

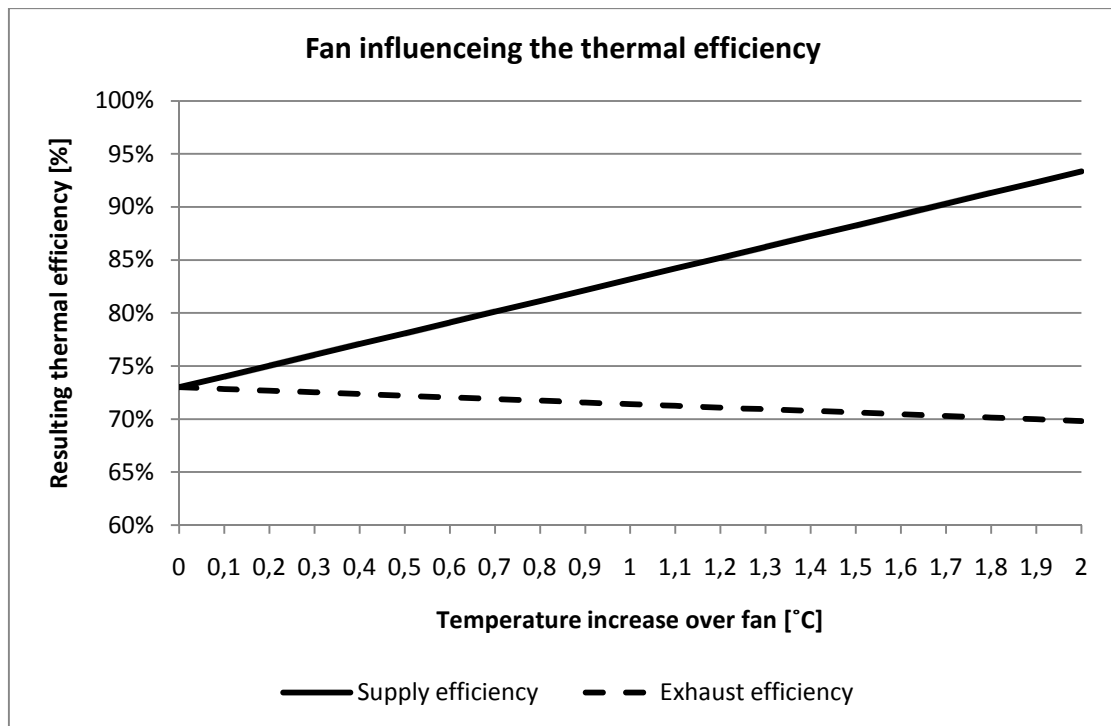

Figure 3.6 An illustration of how the thermal efficiencies vary with increasing temperature lift over the supply and exhaust fan. Here the actual thermal efficiency of the heat exchanger is 73%. With no temperature lift the thermal efficiencies on both sides equal the actual thermal efficiency.

3.2 Verification of results

In order to validate the results of the experiments there is a need for evaluate the accuracy of the testing equipment. This is done by experiments ensuring the quality of the results given by the meters. First an experiment mapping the air temperature distribution in the ducts is carried out followed by an experiment that aims to investigate how the temperature meters deviate amongst each other.

3.2.1 Temperature distribution in a channel

The location of the temperature meters can have significant influence on the test results. In order to be sure that the result given from the temperature meters are reliable there is a need to examine how well the temperature measured at the location of the temperature meters correlates with the mean temperature in the airstream.

Aim

The temperature meters, whose results are used to calculate the thermal efficiency of the heat exchanger, are placed in a drilled hole in the channel. The sensor is eight centimetres long which means that the temperature is measured approximately at the centre of the duct since the duct dimension is 16 centimetres, as seen in Figure 3.7. This test aims to ensure that temperatures measured at this depth returns a representative value for the mean temperature in the channel.

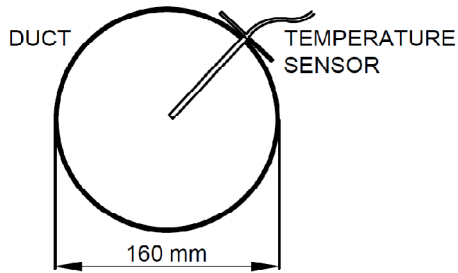

Figure 3.7 Principal sketch of how the temperature sensor is located in the duct. The sensor measures the temperature with the tip of thermometer which is located in the middle of the duct.

Material

1 SwemaAir 300

Method

The temperature distribution is measured in the outdoor and the supply air channels. The SwemaAir 300 is inserted into the same holes where the temperature meters should be placed and the temperature is measured every 10 mm. The SwemaAir 300 is insulated where it pierces the duct, to avoid air infiltration from the surrounding as shown in Figure 3.8

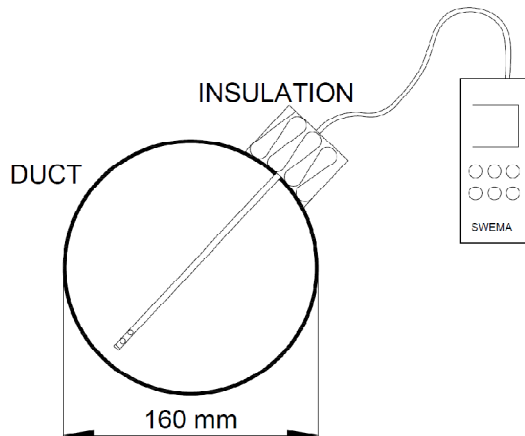

Figure 3.8 Method to measure air temperature distribution in a channel. The penetration hole is insulated in order to avoid air infiltration from the outside.

Result

The temperature distribution varies in the outdoor and supply air duct as shown in Figure 3.9 and Figure 3.10. A dotted line in each figure marks the mean temperature in each case. The deviation between the highest and the lowest temperature in the outdoor and the supply air duct is 0.6 °C respectively 0.3 °C and the maximum deviation from the mean temperature is 0.4 °C and 0.2 °C. In the span of 70-90 mm, where the temperature meters should be placed, the maximum deviation from the mean temperature is 0.1 °C for both the outdoor and the supply air duct.

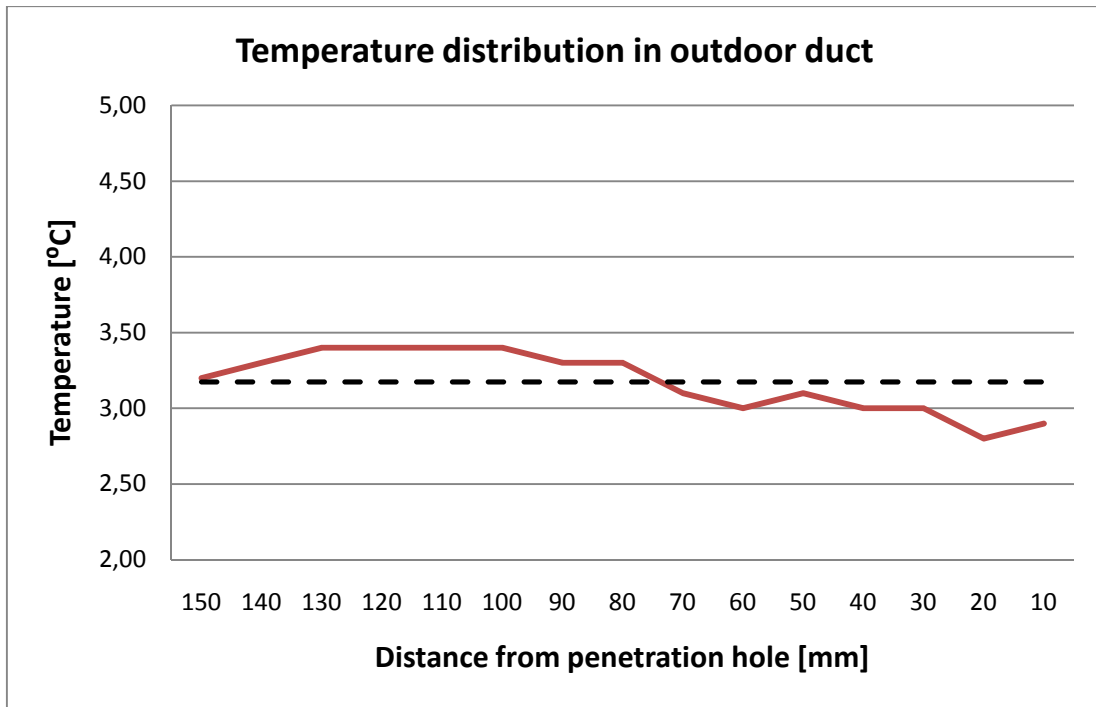

Figure 3.9 Temperature distribution in the outdoor air duct. The temperature deviation is less than 1°C. The dotted line shows the mean temperature.

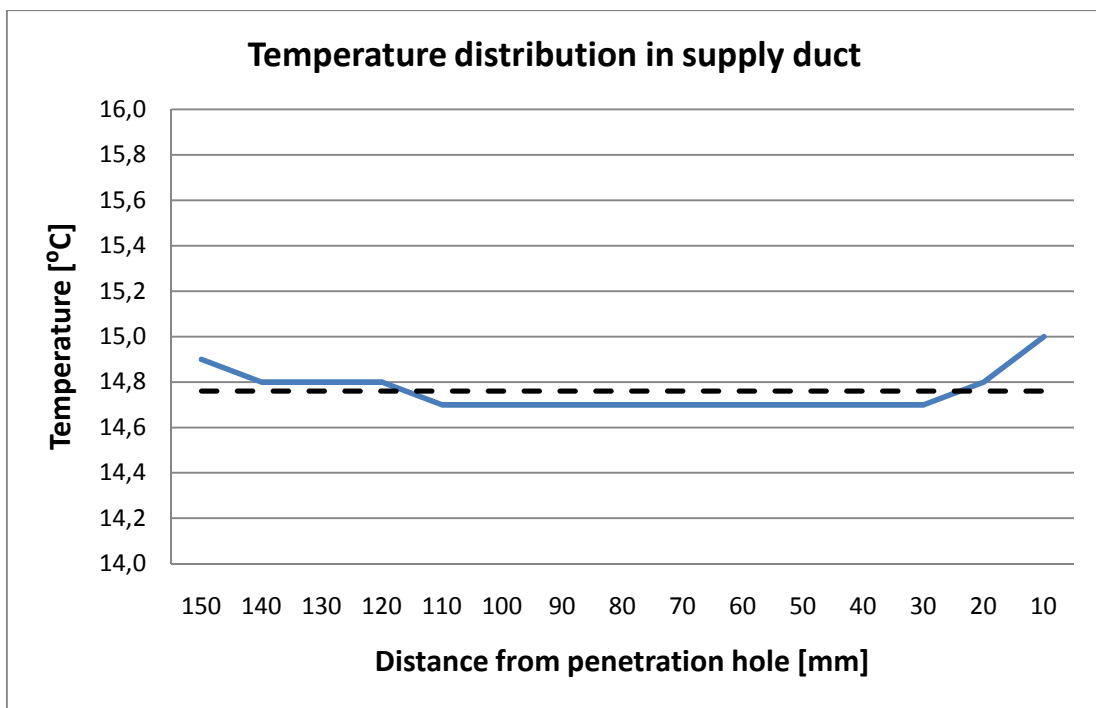

Figure 3.10 Temperature distribution in the supply air duct. The temperature deviation is below 0.5°C. The temperature deviates at most between 0-30 mm into the duct. The dotted line shows the mean temperature.

Conclusion

Since the ambient air had a temperature of about 21 °C during the measurement and the channels are not insulated a reasonable result would show a slightly larger temperature along the sides of the duct. In the supply air channel the temperature

distribution is of such pattern, as Figure 3.10 shows. In the outdoor air duct, however, the temperature distribution shows a more irregular pattern. The cause is probably that the airflow is turbulent at the measurement point. However, the temperature measured 80 mm into the channel corresponds well with the mean temperature in the same point. This is valid for both the outdoor and the supply air side.

The measured temperatures can be considered accurate enough to generate reliable results in this report. But when calculating the uncertainty of the final result, the influence of the location of the temperature meters should be regarded. This uncertainty can be set to ± 0.1 °C since this is the largest deviation between the mean temperature and the measured temperature close to the area where the temperature meters will be placed.

3.2.2 Deviation amongst the temperature meters

Four temperatures are needed in order to calculate a heat exchanger's thermal efficiency on both supply and exhaust side, outdoor, supply, indoor and exhaust temperatures. These temperatures are measured with four individual temperature meters. A well mapped correlation between these meters is needed to ensure an accurate value of the calculated thermal efficiency.

Aim

The aim is to ensure the quality of the temperature meters to verify that they can be used for temperature measurements. The deviation amongst the meters should also be determined.

Material

4 temperature meters, 1 Dostmann P650, 1 ice-water mixture

Method

The temperature sensors were placed through an insulated lid into the ice-water mixture. The reason for using ice and water is that the temperature is known, 0°C, and any measurement deviation may therefore easily be observed. In addition, the Dostmann P650 was put into the ice-water mix. The reason for this is to compare the temperature sensors with a more accurate meter.

Result

The result is shown graphically in Figure 3.11 where the meters measured the temperature. The temperature was constant during the test where three of them measured the temperature to 0.19°C while the last one measured 0.16°C. The more precise Dostmann P650 showed a temperature of 0.07°C. This means that the measurement equipment slightly deviate from the assumed temperature, 0°C, in the ice-water mixture.

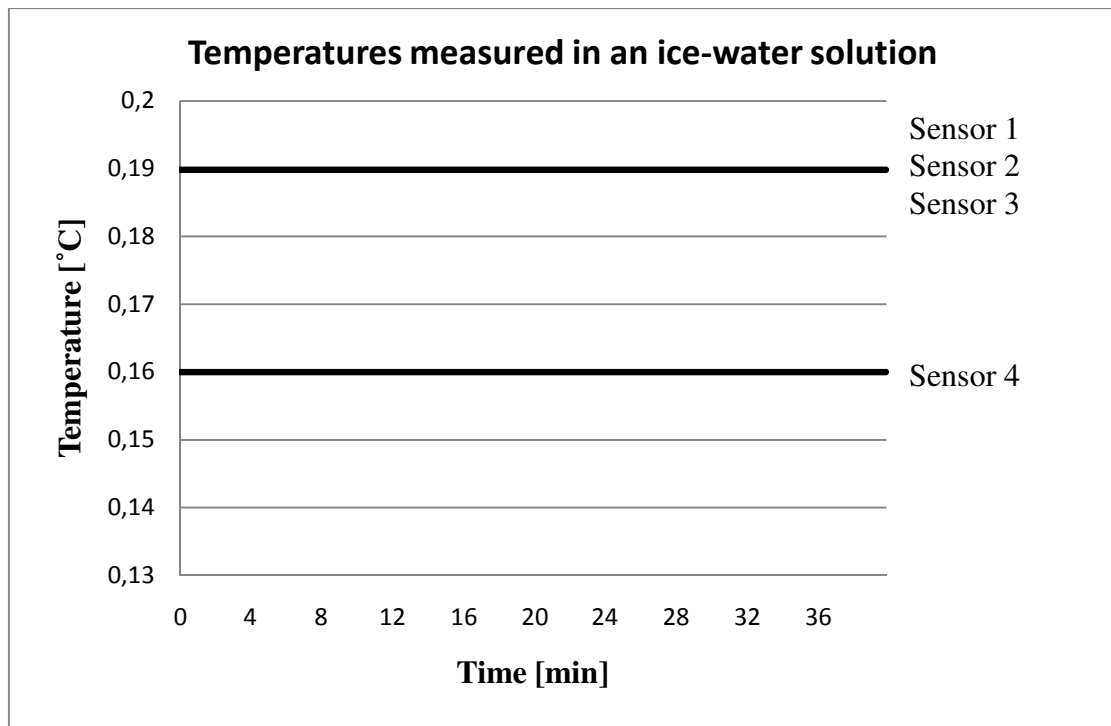

Figure 3.11 Temperatures measured by the temperature meters put in an ice-water mixture. The more precise Dostmann P650 measured 0.07°C in the solution.

Conclusion

The test result shows that the indicators deviate about $0.16\text{-}0.19^{\circ}\text{C}$ from the actual temperature. However, they do not differ considerably between each other or the magnitude of the error is approximately the same for all indicators. Therefore, they are considered to be accurate enough to be used for computing temperatures and thermal efficiencies.

When calculating uncertainties of the temperature sensors the difference between minimum possible value for the Dostmann P650 and the maximum measured value of the temperature sensors could be used. However, the temperature in the ice-water mixture cannot be less than 0°C which means that the Dostmann P650 does only deviate at maximum 0.07°C from the true value of the lower limit in this case. Therefore the temperature meters can be said to measure the temperature with an accuracy of $\pm 0.2^{\circ}\text{C}$.

3.3 Determination of UA-value for a heat exchanger

The UA-value is a measure of how much heat that can be transferred through the heat exchanger at one degree temperature difference. U is a figure that varies dependent on a variety of parameters, such as air speed, grade of turbulence, corrugation and material of the lamella. Predicting the interaction of these parameters returns a relatively unsure value of the heat transfer properties, compared to an experimental solution. Therefore, this section will determine the UA-value for both AHU 1 and AHU 2 experimentally.

The UA-value is an essential property to determine, as it is a required input data when calculating effectivenesses according to an effectiveness-NTU relation. Such relation is described in detail in Section 2.5. It also gives an understanding of the heat transfer properties of the heat exchanger. In addition, it would be of interest to know what parameters that the UA-value depends on and how they can be increased so as to enhance the heat flux further.

Aim

This experiment has the purpose of determining the UA-value of the two heat exchangers in AHU 1 and AHU 2. Two flows will be regarded for both air handling units in order to see how the flow influences the UA-value.

Material

Temperature meters, AHU 1 and AHU 2.

Method

The temperatures of the airflows before and after the heat exchanger at both supply end exhaust side were measured on the test site described in Section 3.1.3. The magnitude of the airflow was also registered during the test. An assumption made during the calculations was that the energy change of one airstream is equal to the heat transferred through the lamellas. This gives the relation

$$\dot{V}\rho c_p \Delta t = UA\Delta t_{ln} \quad (3.1)$$

Since the airflow and all temperatures are measured, the UA-value for the heat exchanger can be determined according to equation (3.1). This method considers the heat exchanger as a closed system and does not take any heat exchange with the surroundings into consideration.

Flows in AHU 1 were set to 55 l/s and 86 l/s and for AHU 2 they were set to 55 l/s and 82 l/s. The reason AHU 2 was set to this flow is that the fans could not reach an airflow of 86 l/s in AHU 2. The heat transfer area, A, is 45 m² for AHU 1 and about 63 m² for AHU 2. A large UA-value is desired, since the purpose of a heat exchanger is to transfer as much heat as possible.

Results

The UA-value has been calculated for two different airflows in each unit. AHU 2 has a higher UA-value than AHU 1. The results for both air handling units are presented in Table 3.2. The UA-value is higher for the case with higher flow, even though the thermal efficiency is decreased.

Table 3.2 Calculated UA-value for AHU 1 and AHU 2 according to measurements.

	AHU 1		AHU 2	
Airflow [l/s]	Supply efficiency [%]	UA-value [W/K]	Supply efficiency [%]	UA-value [W/K]
55	70	177	82	208
86	67	203	81	282

Conclusion

For both units the UA-value increased for the higher flow. A higher airflow through the heat exchanger means that the airspeed also increases. The convective heat

transfer coefficient, described in Section 2.1, depends on the airspeed along the surface and is increased with a larger airspeed. The U-value for one lamella is calculated according to equation (2.24) and depends on the convective heat transfer coefficient. Consequently, an increased airspeed will induce an increased UA-value. This seems to be valid even though the thermal efficiency is lowered. It seems like the UA-value is strongly dependent on the airspeed.

3.4 Thermal efficiency of heat exchanger

One of the main purposes of this master thesis is to improve the heat exchanger which is placed in the air handling unit, which was presented in Section 3.1.2. One way of grading the heat exchanger is to measure its thermal efficiency, η_t , as it reveals how much energy that has been recovered.

Aim

The purpose of this experiment is to determine the thermal efficiency of the heat exchangers, at their original design. It is a vital knowledge to have when doing changes in the design of the heat exchanger, in order to be able to compare the new thermal efficiency with the original one. The thermal efficiency, η_t , is a good indicator if the changes made implies any improvements or not.

Material

Temperature meters, AHU 1 and AHU 2.

Method

The thermal efficiency, on the supply side, was calculated according to equation (2.7) by measuring the necessary temperatures. All temperatures were measured in the ducts in direct connection to the air handling unit during several periods of time with similar outdoor conditions. The temperature indicators were put into the ducts according to Figure 3.7 and registered the temperature every fifth second. The airflows were 55 l/s and 86 l/s for AHU 1 respectively 55 l/s and 82 l/s for AHU 2.

Results

The results are presented in Figure 3.12 to Figure 3.15 where the thermal efficiency is shown for the two air handling units and the different flows. Each measurement carried out for AHU 2 was done during night-time when the outdoor temperature was low. Then a selection of values was picked out where the outdoor temperature is relatively constant, since the air density will affect the thermal efficiency according to Section 2.4. Another reason for doing measurements during low outdoor temperature conditions is that a low outdoor temperature implies a larger temperature difference in equation (2.7) and therefore a more accurate value of the thermal efficiency. If all thermal efficiencies are measured during similar conditions they will be easier to compare without taking the effect of the air density into consideration.

For AHU 1, the average efficiency for the low flow case is 73.0% while it is 74.6% for the high flow case. The denser AHU 2 returns higher values, 82.3% for the low flow and 80.8% for the high flow.

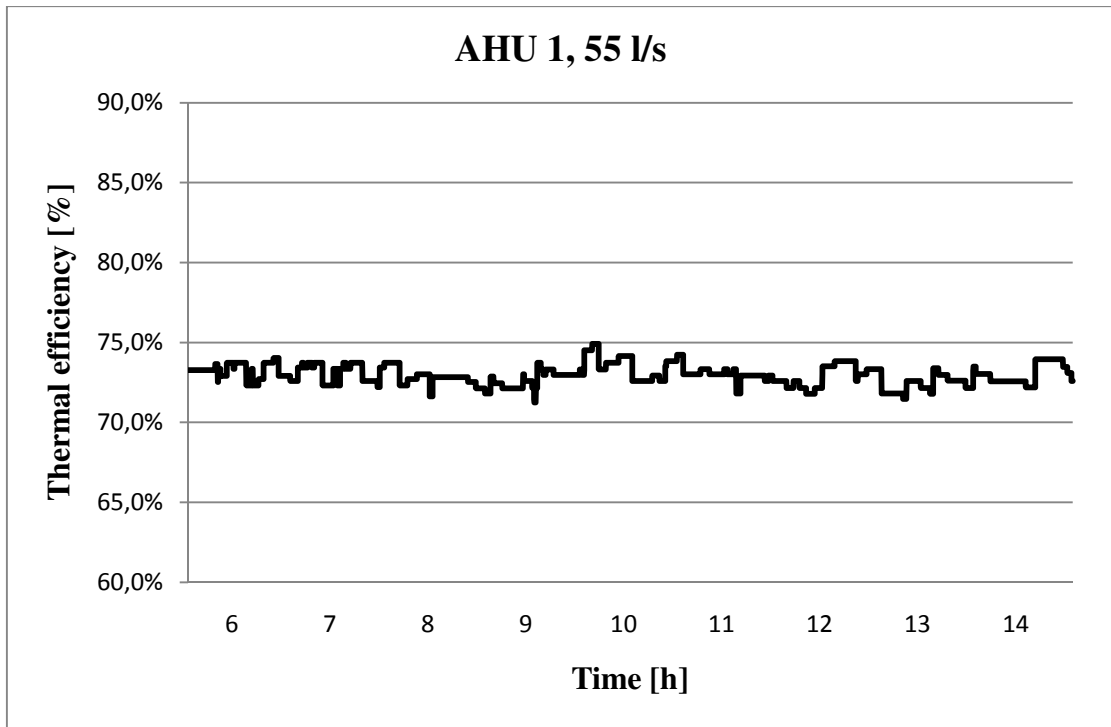

Figure 3.12 Thermal efficiency of the AHU 1 with an airflow of 55 l/s. The outdoor air temperature varied between 10-12 °C with a mean temperature of 11.1 °C. A certain period during the measuring time was chosen when the outdoor temperature was constant which is why the values on the x-axis do not start with zero.

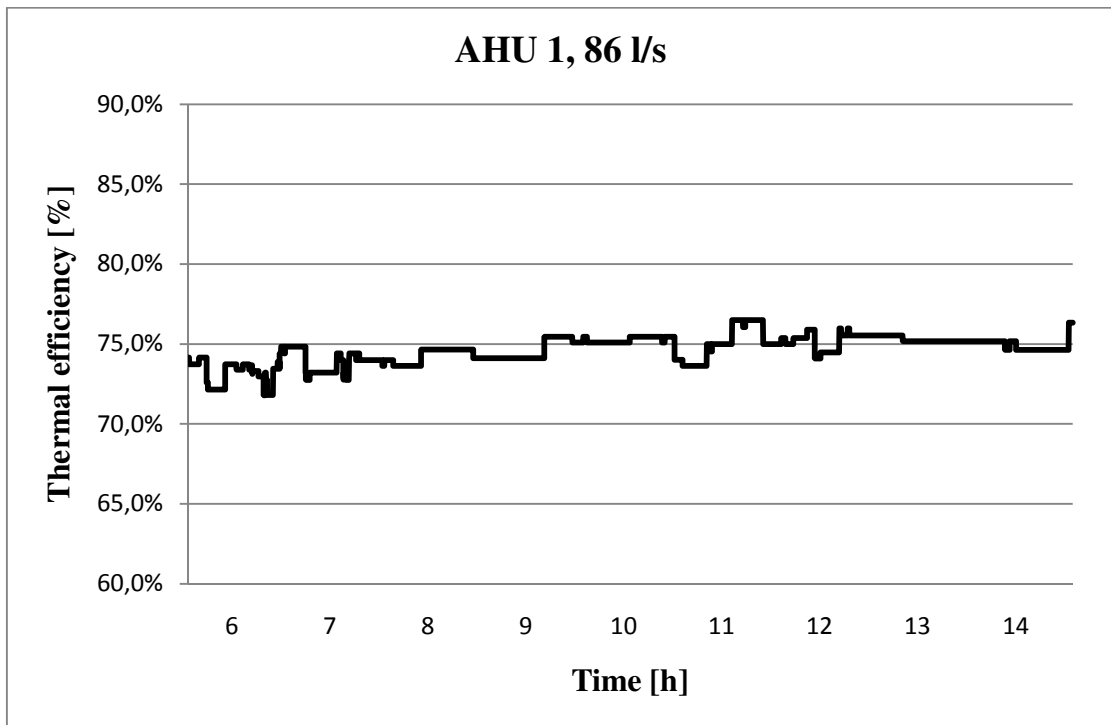

Figure 3.13 Thermal efficiency of AHU 1 with an airflow of 86 l/s. The outdoor air temperature varied between 10.7-11.7 °C with a mean temperature of 11.3 °C.

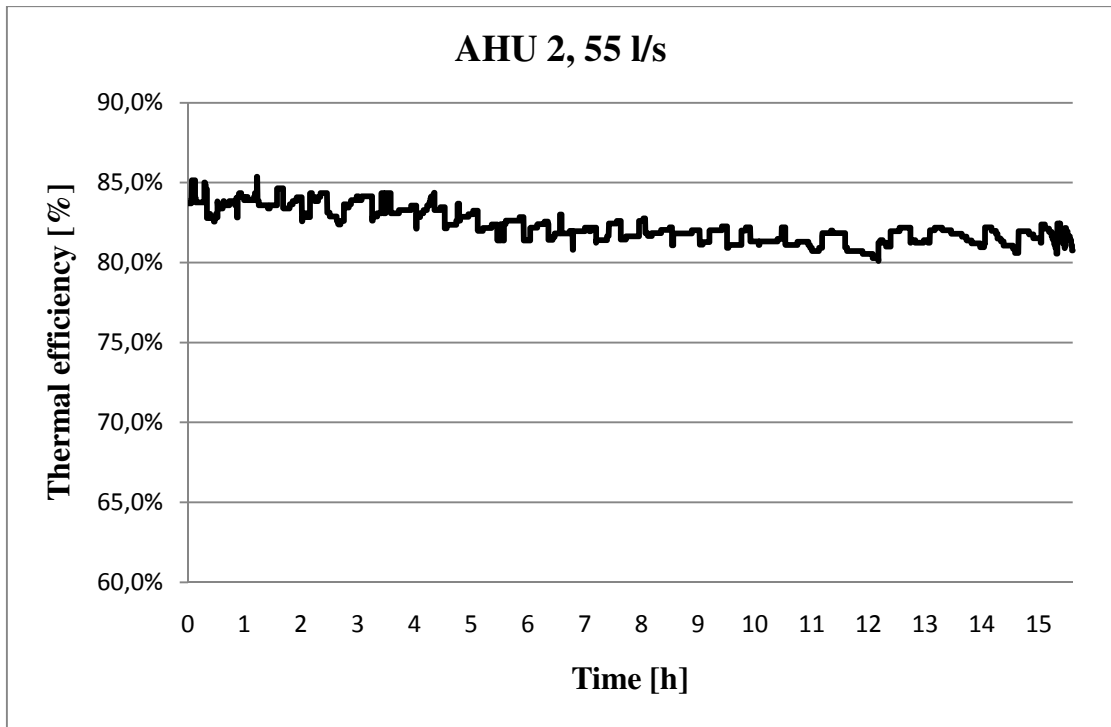

Figure 3.14 Thermal efficiency for AHU 2 for the low flow case. The temperatures were measured during one night with relatively constant outdoor temperature which is why the thermal efficiency is also relatively constant. Outdoor air temperature varied between 5-10°C with a mean temperature of 7.2°C.

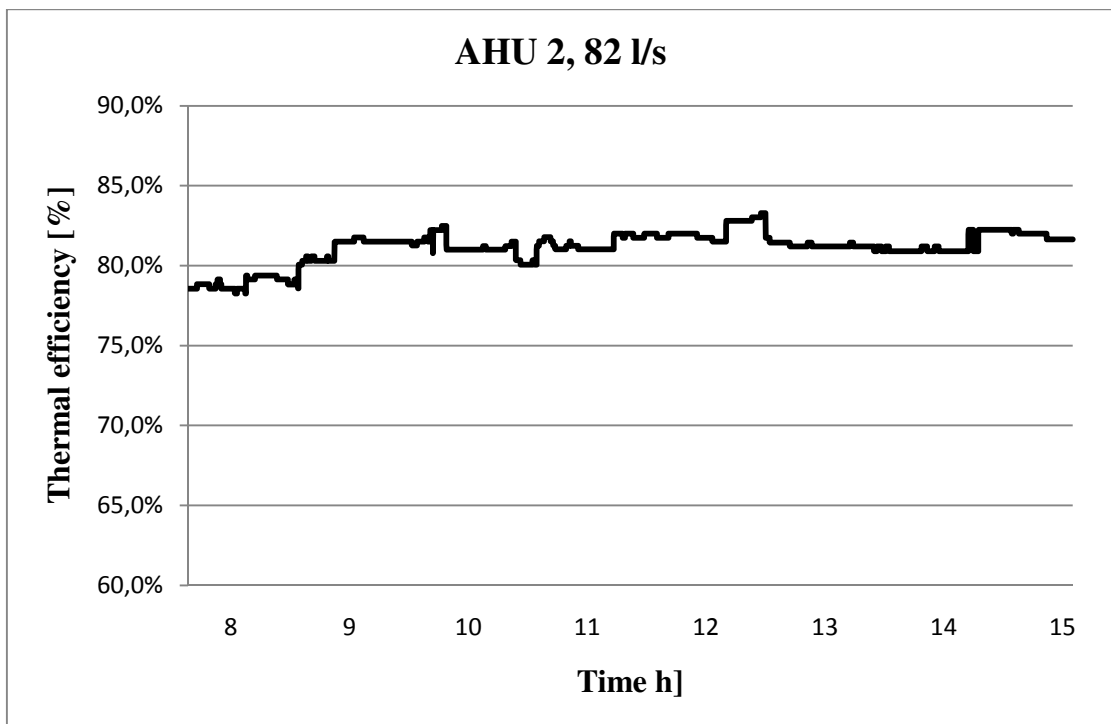

Figure 3.15 Thermal efficiency for AHU 2 for the high-flow case. The temperatures were measured during one night and the thermal efficiency was calculated for a time period when the outdoor temperature was low and relatively constant. The outdoor air temperature varied between 8-10°C with a mean temperature of 8.8°C.

Conclusion

The thermal efficiency differs slightly dependent on what size of airflow that runs through the air handling unit. The unit has a better efficiency when the airflow is lower, as can be seen when comparing the figures for the low-flow case with the figures for the high-flow case. One explanation to this behaviour may be done by the ϵ -NTU relation presented in Section 2.5. According to equation (2.19) is the effectiveness a function of NTU and a ratio between the minimum and maximum heat capacity rates through the heat exchanger.

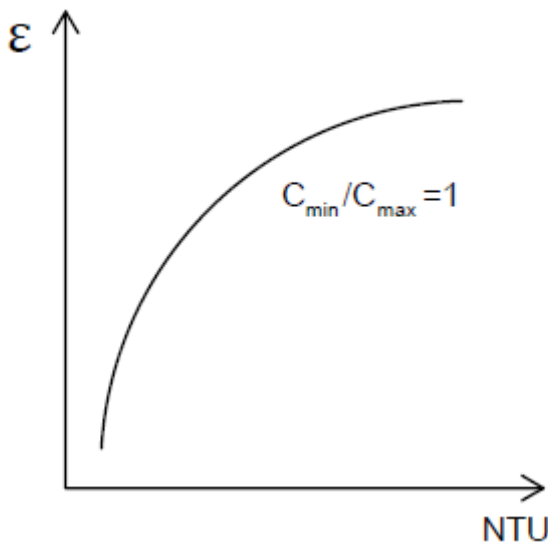

Figure 3.16 Principal diagram of how effectiveness is related to NTU.

This ratio equals one in our case as the supply and exhaust airflows are of identical size in the measurements. Figure 3.16 shows how the effectiveness principally varies with the NTU-value, on condition that both heat capacity rates are of same size.

The NTU-value is determined according to equation (2.20) and is decreased when the airflow is increased, since the thermal efficiency and effectiveness decreases. The NTU-value depends on the UA-value and C_{\min} . What probably happens when the airflows are increased is that the U-value, and hence the UA-value, is increased since larger air speed implies greater heat transfer. But C_{\min} increases more than the U-value, why the NTU-value decreases. A lower NTU-value results in a lower effectiveness, according to Figure 3.16.

As all temperatures were measured after or before the air enters the air handling unit, the temperatures may have been affected not only by the heat exchanger but also by the fans. The fans are considered to heat up the airflows slightly since they pass straight through them. Heat transfer is also likely to take place between the air handling unit and the ambient air. These temperature changes due to other effects than in the heat exchanger, may affect the resulting thermal efficiency. Nevertheless, since only thermal efficiencies are compared with each other, any improvements will still be visible despite these errors.

3.5 Airflow distribution and effectiveness of the heat exchanger

According to the theory about efficiencies in Section 2.2, the thermal efficiency depends not only on the relation between the supply and exhaust flows, but also on how the airflows are distributed through the heat exchanger. It is therefore an important experiment to do as the thermal efficiency tells how efficient the heat exchanger is. The theory calculations in this section is based on a counter flow heat exchanger without corrugation, which explains the slightly lower resulting values for the effectiveness in table Table 3.3. However, what is important here is to note the variation in effectiveness for different flows.

Aim

The aim is to measure the flow distribution on the heat exchanger's exhaust and supply side to evaluate if there is room for improvements regarding the air distribution between the lamellas. In addition, the effectiveness of the heat exchanger, corresponding to the actual air distribution through it, should be determined. This should be compared with the effectiveness when the air is perfect distributed to see what improvements that can be done. All experiments should be executed on both AHU 1 and AHU 2.

Material

1 SwemaAir 300, 2 plexiglass boards, 2 pipes, AHU 1 and AHU 2

Method

A transparent plexiglass board was mounted at the bottom of the heat exchanger so that the outlet of the exhaust could be seen even with the cover on. A hole is piercing the plexiglass, allowing insertion of the SwemaAir 300 to carry out the necessary measurements. The SwemaAir 300 was mounted inside a 65 mm diameter pipe, as seen in Figure 3.18, in order to avoid disturbances from turbulent air right after the heat exchanger. Measurements regarding both flow and temperature were carried out in 15 different spots creating a homogenous pattern over the bottom of heat exchangers, as seen in Figure 3.17 and Figure 3.19. This assembles the channels in five groups with approximately 6-7 channels in each group. Three values were measured in each group, left side, middle and the right side. The experiment was carried out four times to reduce the risk for reading errors and it was done for the flows 55 l/s respectively 86 l/s for AHU 1 and 55 l/s and 82 l/s for AHU 2. The velocity distribution was mapped on the supply side in the same manner. Simultaneously, the temperatures were measured in order to be able to calculate the UA-values for the heat exchangers for all air flows.

To calculate the effectivenesses for the heat exchangers the UA-value was calculated according to equation (3.1) and a mean value for each lamella was used. The effectiveness was then calculated for each group according to equation (2.21) and (2.22) and an overall effectiveness was calculated with respect to the airflow in each channel.

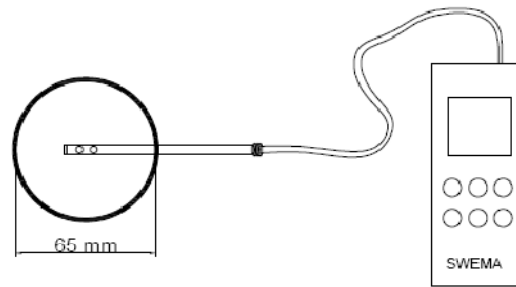
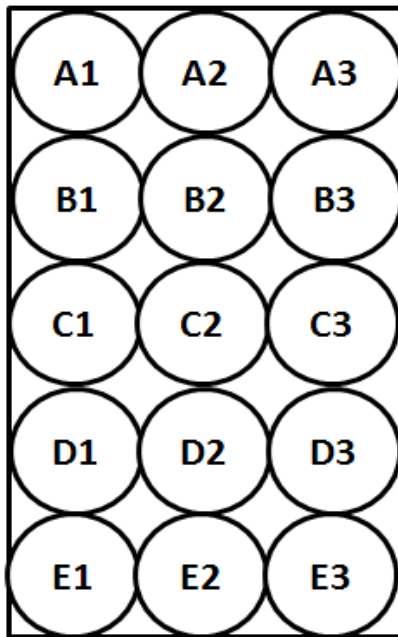

Figure 3.17 Measuring points. One temperature and velocity was measured in each point then the mean value was calculated for each group (A,B,C,D,E). Group A is located at the innermost of the heat exchanger.

Figure 3.18 Arrangement of the Swema Air 300. The measuring node was placed in the middle of the cylinder

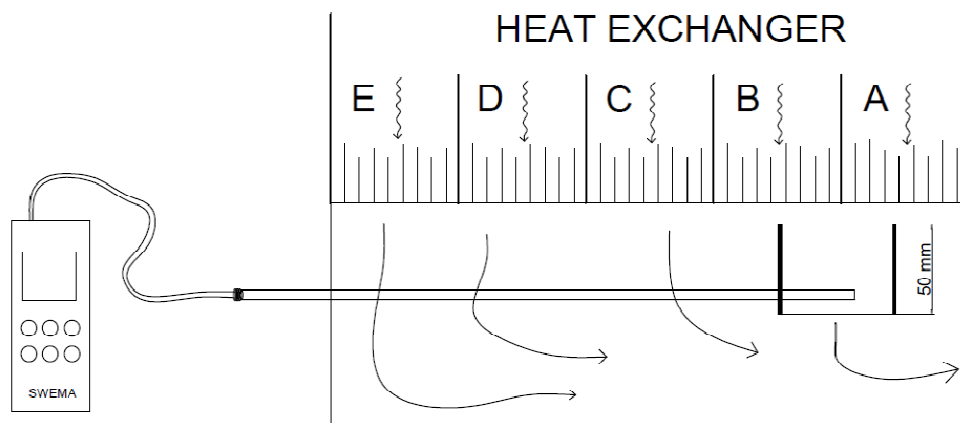

Figure 3.19 Procedure of measuring velocities. The cup with the measuring node was inserted below the heat exchanger, taking measurements on the out-coming air. The same method was used to map the airflow distribution at the supply side.

Result

The results are presented in diagrams where the airflow in each group is presented as percentage of total flow. Both Figure 3.20 and Figure 3.22 present the air distribution on the exhaust side in AHU 1, whereas Figure 3.21 and Figure 3.23 present the corresponding distributions for AHU 2. In all exhaust distributions are a significant

part of the airflow concentrated to group B and C, while the smallest flows are located in group A and E.

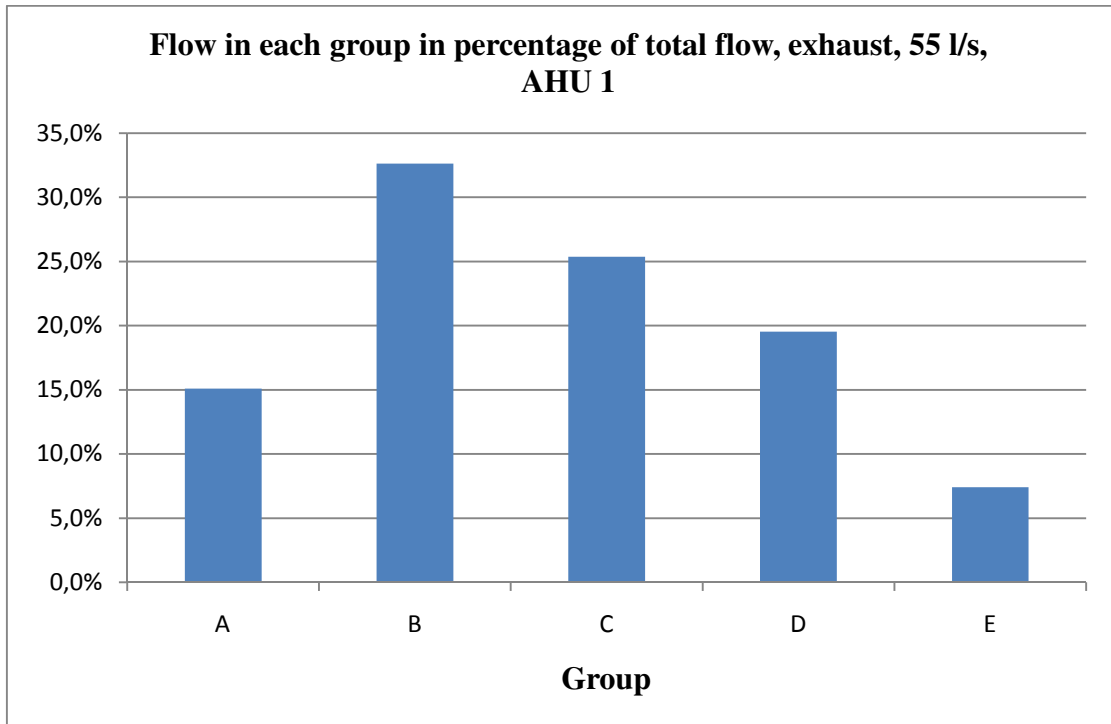

Figure 3.20 Flow distribution on exhaust side in AHU 1 for the low-flow case. The flow share in group B is 4.4 times larger than it is in E.

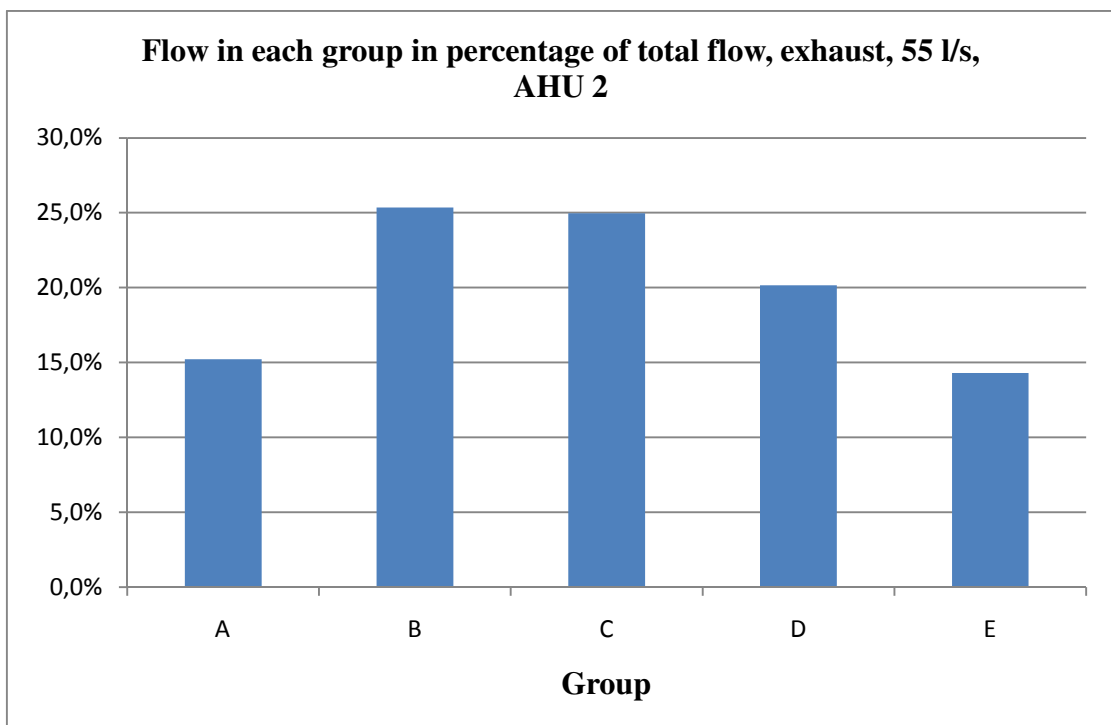

Figure 3.21 Flow distribution on exhaust side in AHU 2 for the low-flow case. The flows are largest at channels in the middle of the heat exchanger.

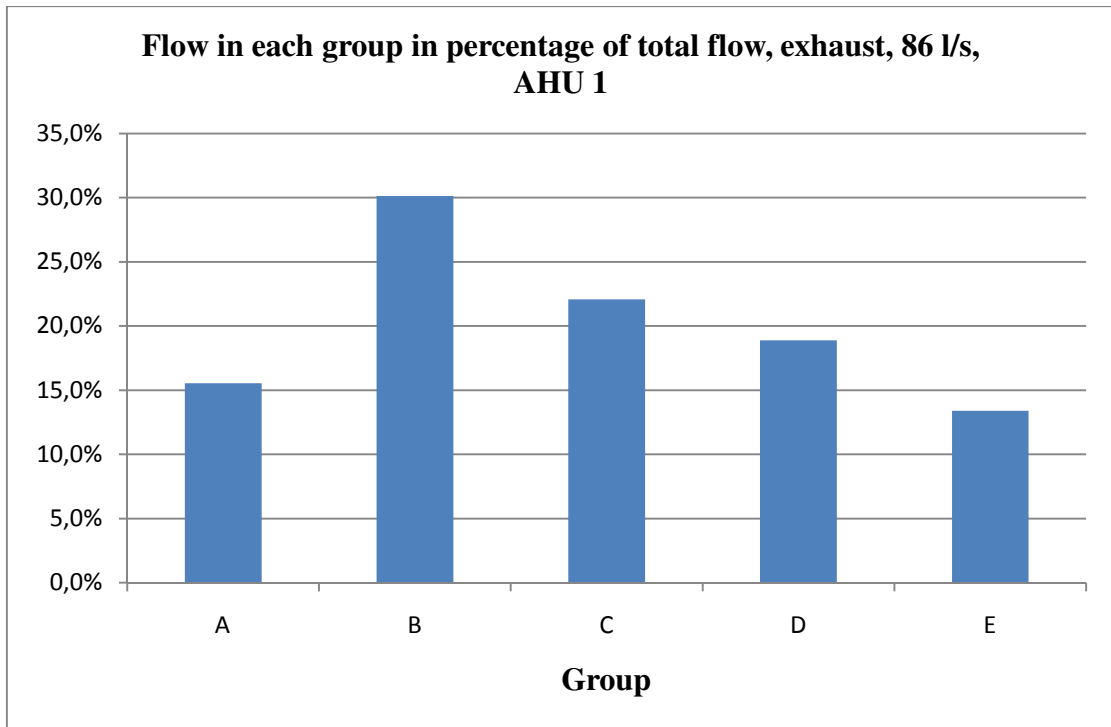

Figure 3.22 Flow distribution on the exhaust side in AHU 1 for a flow of 86 l/s. Like Figure 3.20 this distribution shows great variation in the flow distribution in different channels.

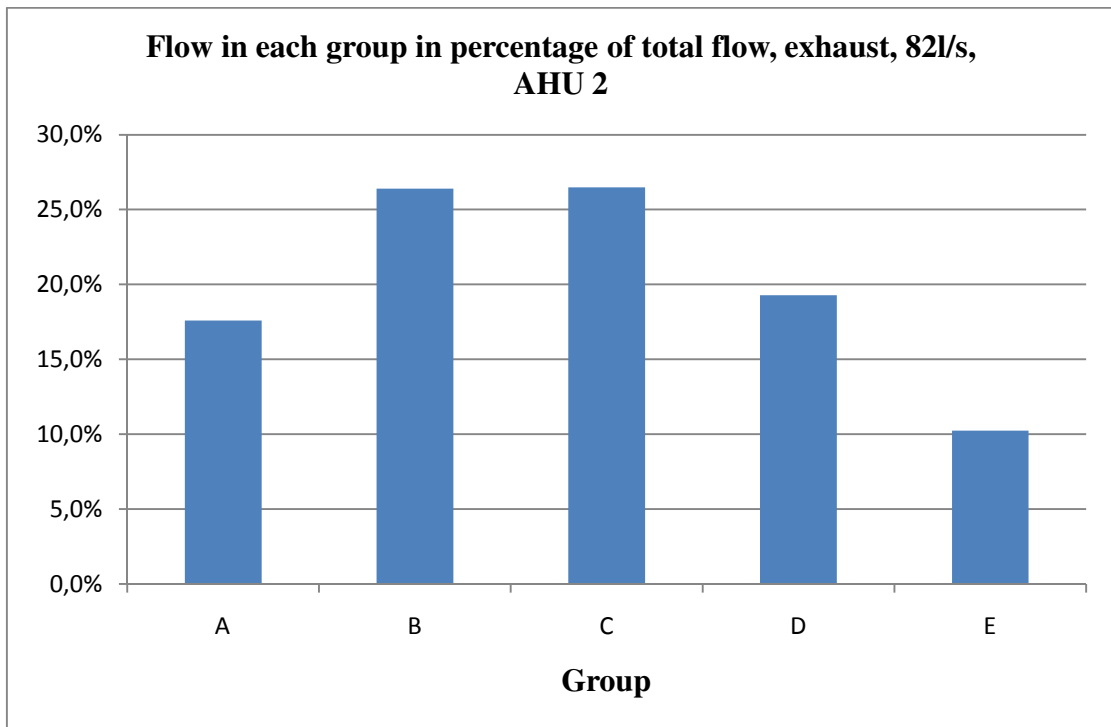

Figure 3.23 Flow distribution on exhaust side in AHU 2 for the high-flow case. The distribution shows the same pattern as the low-flow case on AHU 2.

On the supply side the airflow distribution looks as presented in Figure 3.24 and Figure 3.26. This airflow distribution is, compared to the exhaust air distribution, more even. The air flow share in the low-flow case varies from 16% to 23% and the

high-flow case varies from 16% to 21%. The smallest airflow is located in group A in both cases.

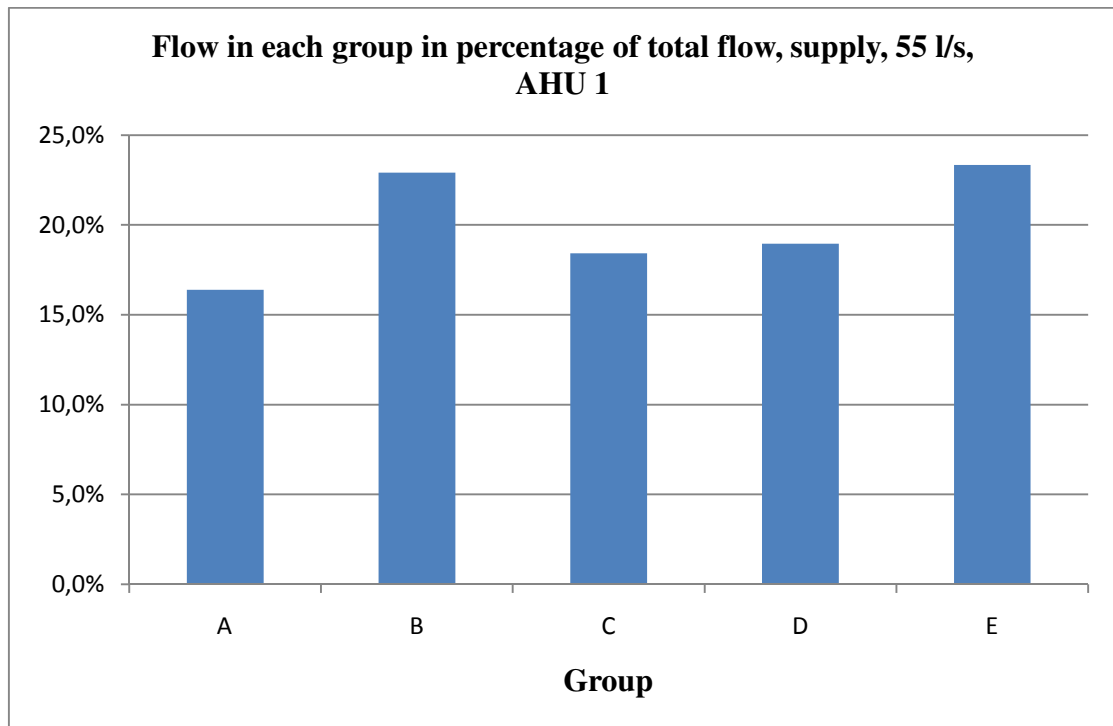

Figure 3.24 Flow distribution in AHU 1 on the supply side for the low-flow case.

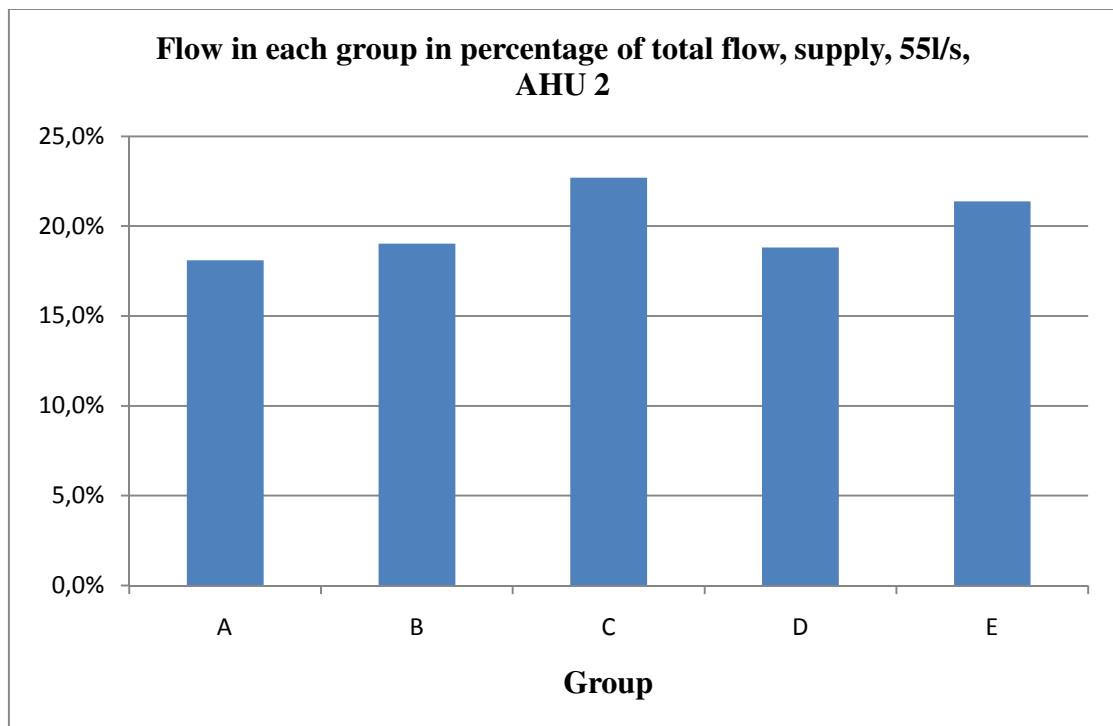

Figure 3.25 Flow distribution in AHU 2 on the supply side for the low-flow case.

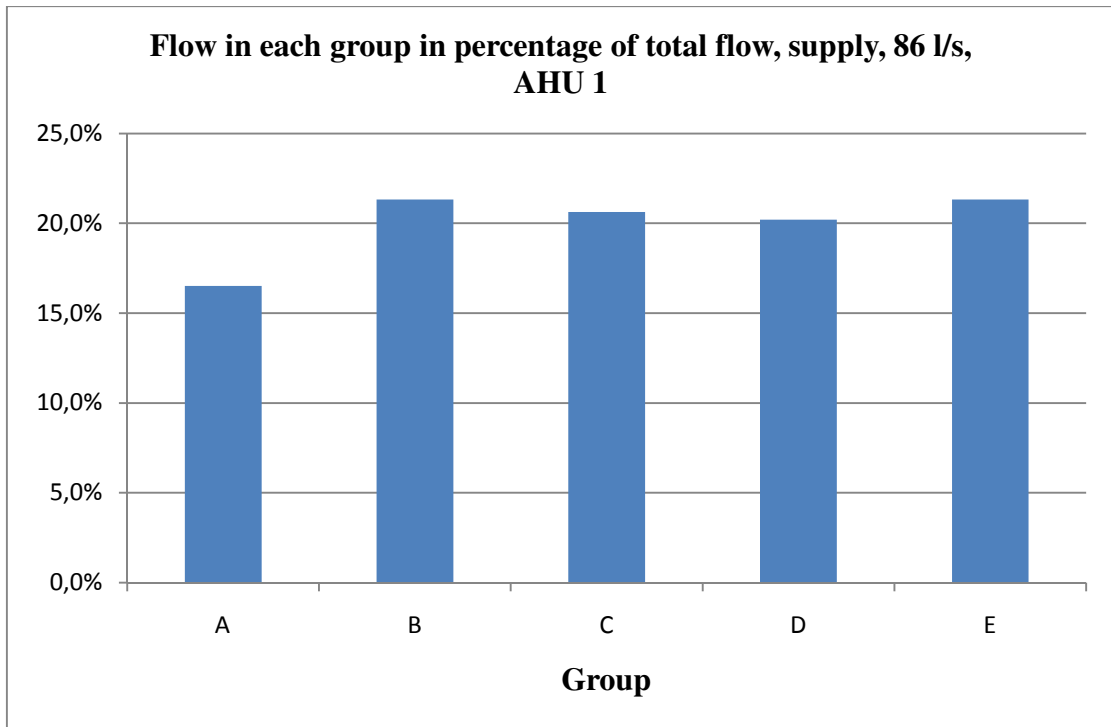

Figure 3.26 Airflow distribution in AHU 1 on the supply side for the high-flow case.

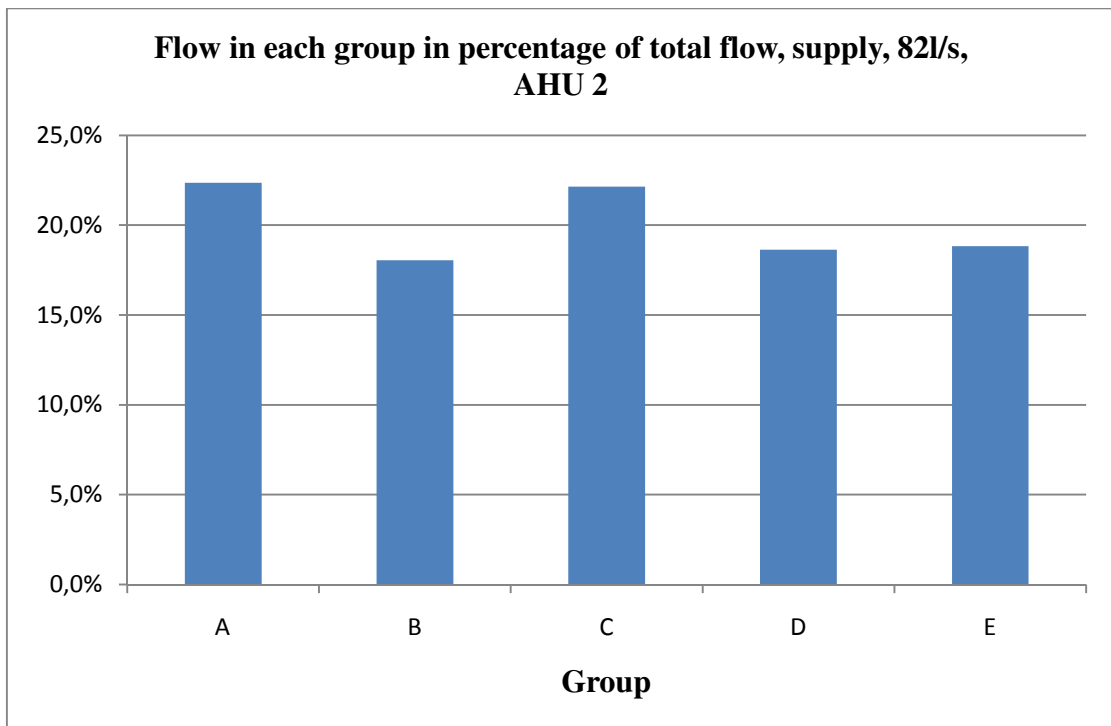

Figure 3.27 Airflow distribution in AHU 2 on the supply side for the high-flow case.

From the measured flow distribution and UA-values a theoretical effectiveness was calculated from equation (2.21) for both flows. The effectivenesses were also calculated for an even airflow distribution. These effectivenesses are presented in Table 3.3. The deviation between the effectiveness for the actual flow distribution and

the effectiveness for an even distribution is greater in the low flow case since the UA-value for the low-flow case is lower than it is for the high-flow case. The calculations show that it should be possible to increase the effectiveness by 13.8 percentage units for the low-flow case and 7.4 percentage units for the high-flow case.

Table 3.3 Theoretical effectivenesses for the heat exchanger, with the measured airflow distribution and an even airflow distribution. The corrugation of the lamellas has not been taken into consideration in the calculations.

	55 l/s	86l/s
Effectiveness for actual flow distribution	51.5%	56.1%
Effectiveness for an even distribution	66.9%	63.3%
Deviation	13.8%	7.2%

Conclusion

It is evident that the exhaust flow in the channels located in the middle of the heat exchanger is greater than it is in the outer and inner channels for both AHU 1 and AHU 2. All measurements on the exhaust side returns an unfavourable distribution where a great part of the airflow is concentrated in B and C. The distribution is, however, a little bit better in AHU 2 than in AHU 1. For instance, for the low-flow case in AHU 1 runs about 60% of the total airflow in group B and C, while only 7% runs in group E. The distribution is slightly better for the high-flow case but it still shows a distribution similar to the low-flow case, in the exhaust side. The reason for these uneven distributions at the exhaust side is probably due to the fact that the exhaust fan is located before the heat exchanger. The airstream from the fan is concentrated on group B and C where the largest airflows runs according to the measurements.

On the supply side, however, is the supply fan placed after the heat exchanger and hence, creating a better distribution. According to the results is the supply distribution definitely better than the exhaust distribution. The airflow share in each group is approximately within 18-22% for all cases. Therefore, the supply distribution is considered to be good enough not to consider any guidance of the supply airflow through the heat exchanger.

According to Table 3.3 does an even airflow distribution return a higher effectiveness for all flows. The effectiveness-values are first calculated according to the actual flow distribution through the heat exchanger and then when the airflows were assumed to be even distributed. The deviation between the predicted effectiveness for the actual flow and the measured thermal efficiency in Section 3.4 is likely due to the equation (2.21), which does not take the printed pattern on the lamella surface into consideration. This print should increase the turbulence in the airstreams and consequently the effectiveness. The important information from Table 3.3, however, is the fact that the effectiveness may be increased when having an even distribution instead of an uneven distribution. Hence, methods concerning guidance of air should be investigated to even out the flow and increase the effectiveness of the heat exchanger.

There might be some problems with this measurement method regarding precision. The method divides the exhaust of the heat exchanger into five groups. This provides a relatively low resolution on the test results. It would be of interest to measure the flow in each heat exchanger channel and not on channel groups.

3.6 Redistribution of air by air guides and the resulting thermal efficiency

It is shown in Section 3.5 that the exhaust air is uneven distributed through the heat exchangers. Calculations made in the same section reveals the fact that an even distributed air through the heat exchanger will result in an increased effectiveness. Therefore the possibility to distribute the exhaust airflow more even with air guides in the airstream between the exhaust fan and the heat exchanger should be investigated. The following section will present the experiments concerning guidance of airflow on the exhaust side and a selection of the air guide configurations.

Aim

The aim with the experiment is to increase the thermal efficiency of the heat exchanger by redistributing the airflow on the exhaust side. The flow should be as equal as possible in every channel in the heat exchanger. The experiment should be carried out for two different flows and air handling units. An air guide configuration creating an even airflow distribution for both of the cases should be sought for.

Material

AHU 1, AHU 2, 3 cut cardboard rectangles (Figure 3.28), 1 SwemaAir 300, 1 plexiglass board, 1 pipe.

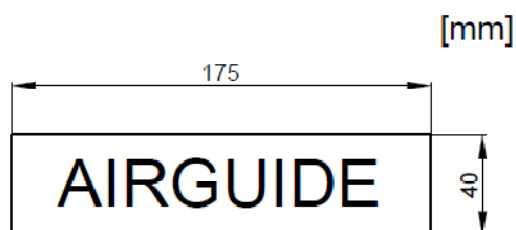

Figure 3.28 Dimensions of the cardboard rectangle used for air guiding.

Method

The air handling unit with the duct system and the temperature sensors were arranged as in Section 3.1.3. Cardboard air guides were placed in different patterns in the area between the exhaust fan and the heat exchanger and the temperatures were continuously logged so that the thermal efficiency could be calculated for each configuration. Some cases were more closely monitored and measured during a whole night, when the outdoor temperatures were lower than during the day. These measurements lasted approximately 15-16 hours and were carried out for the case with no air guides and for configuration 3 for both AHU 1 and AHU 2. Since these experiments are carried out during night-time, when the temperature difference between room and outdoor air are larger than during the day, they should return a more certain value.

During each test the airflow distribution was measured in the same manner as in Section 0. After each time a setup was tested, the resulting airflow distribution was evaluated and an educated guess for improving the distribution with an upgraded configuration was made. Then the same method was used for testing the new setup. A complete even airflow distribution will be when 20% of the total flow runs through each group in the heat exchangers. During all experiments the power to the air

handling unit was monitored and those results are presented in 3.7. For AHU 1 the experiment was carried out for two flows, 55 l/s and 86 l/s, and for AHU 2 it was done for the flows 55 l/s and 82 l/s.

Result

A selection of setups for the air guides with their corresponding thermal efficiency is presented in the following sections. The measured thermal efficiencies for the two air handling units with no air guidance are taken from Section 3.4. The thermal efficiency for AHU 1 was measured to 73.0% for the low-flow case and 74.6% for the high-flow case and for AHU2 82.3% for the low-flow case and 80.8% for the high-flow case. The experiments carried out during night

Configuration 1

One cardboard air guide was placed right below the fan exhaust, as seen in Figure 3.29, in order to relocate the air that flows through channel group B to the outer channel groups. This configuration resulted in an airflow distribution presented in Figure 3.30 to Figure 3.33. The high-flow case returns a more evenly distributed airflow between the channels, especially for AHU 1. However, in all cases the airflow distribution is concentrated in the middle channels of the heat exchanger. The thermal efficiencies are presented in Table 3.4.

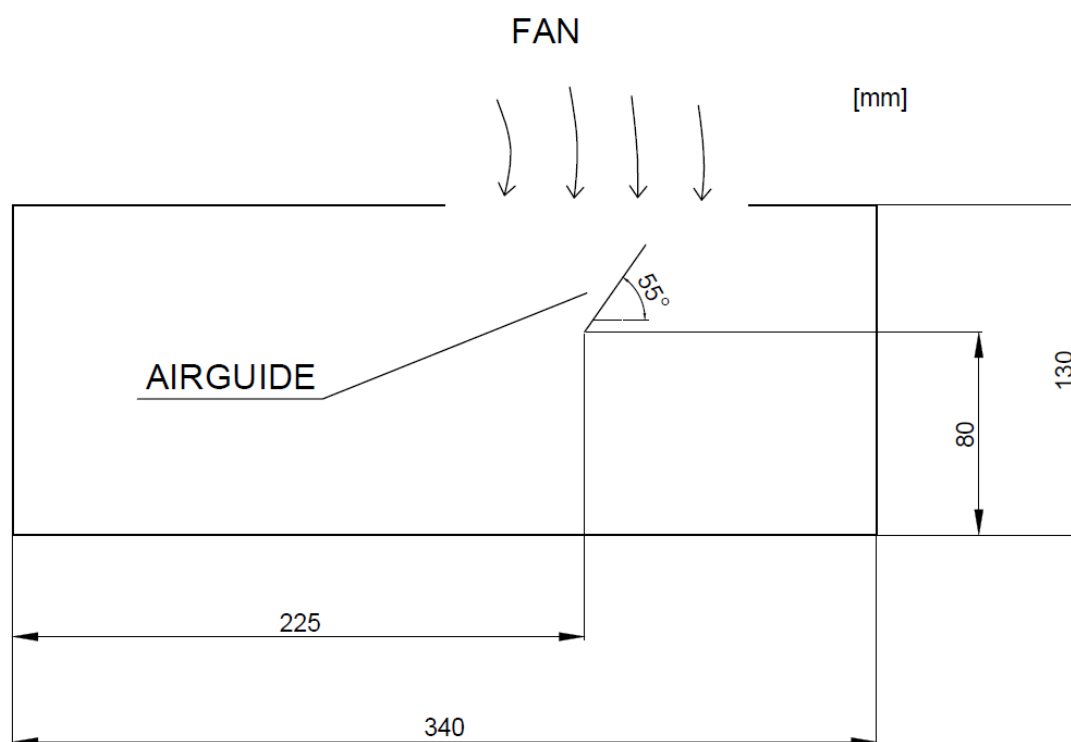

Figure 3.29 Air guide configuration 1. One cardboard guide was used.

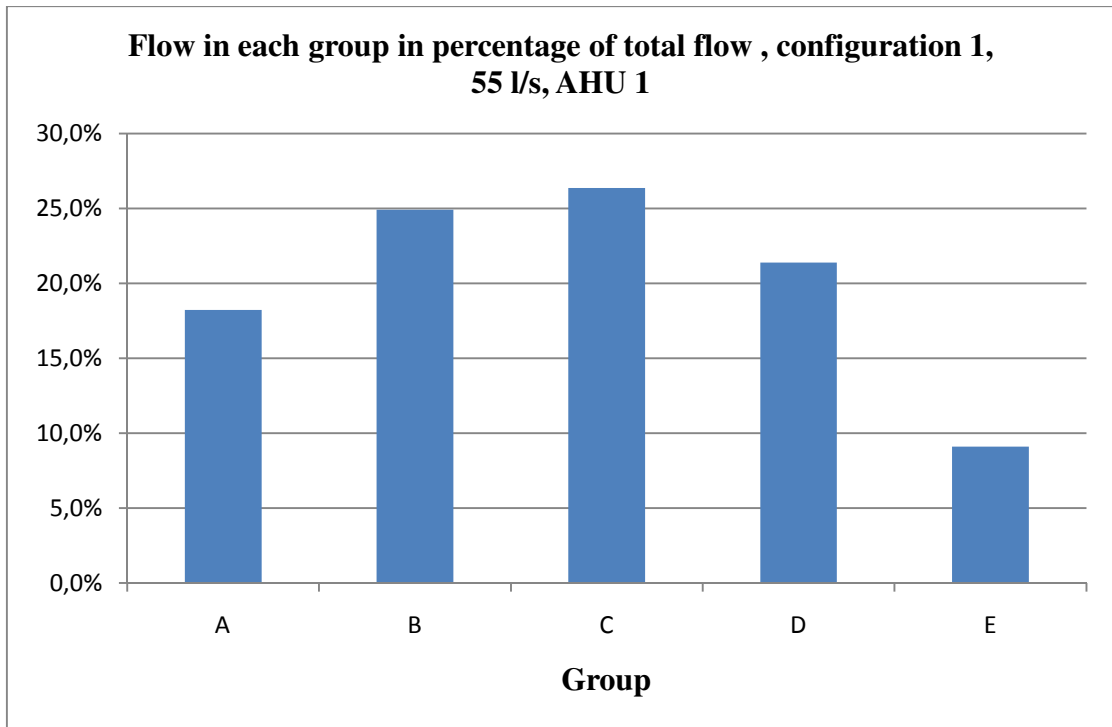

Figure 3.30 Airflow distribution for configuration 1 for the low-flow case. The flow in group B has been reduced compared to the original distribution but the flow through group A and E are still smaller than the flow in the other groups.

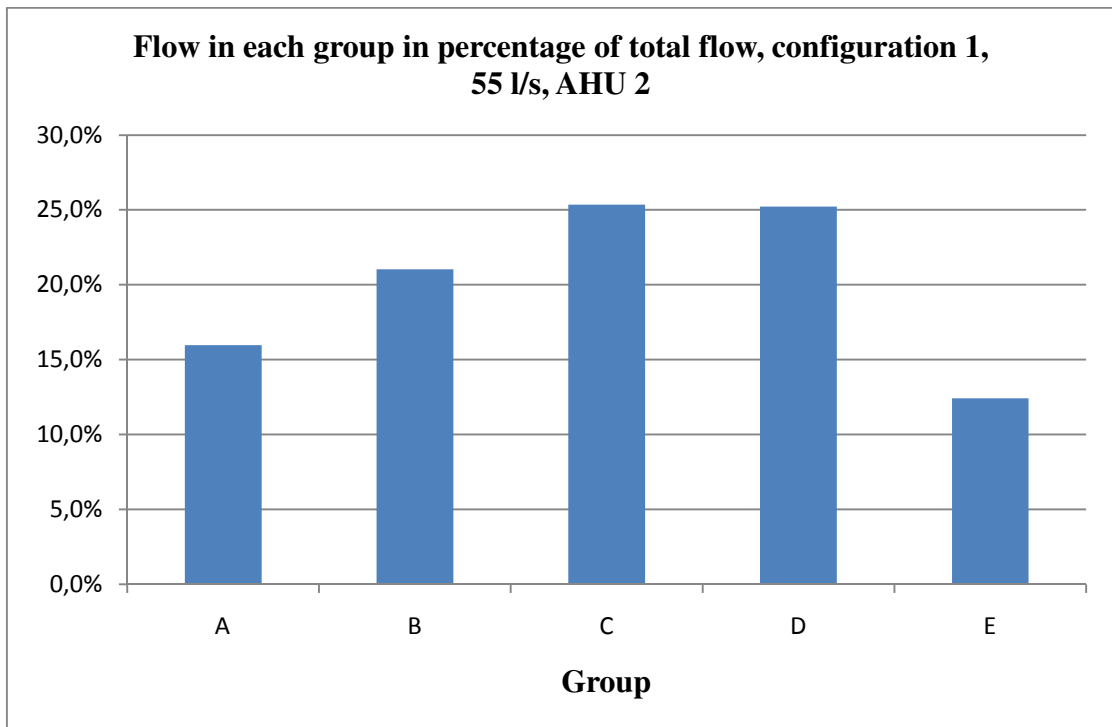

Figure 3.31 Airflow distribution for configuration 1 for the low-flow case in AHU 2.

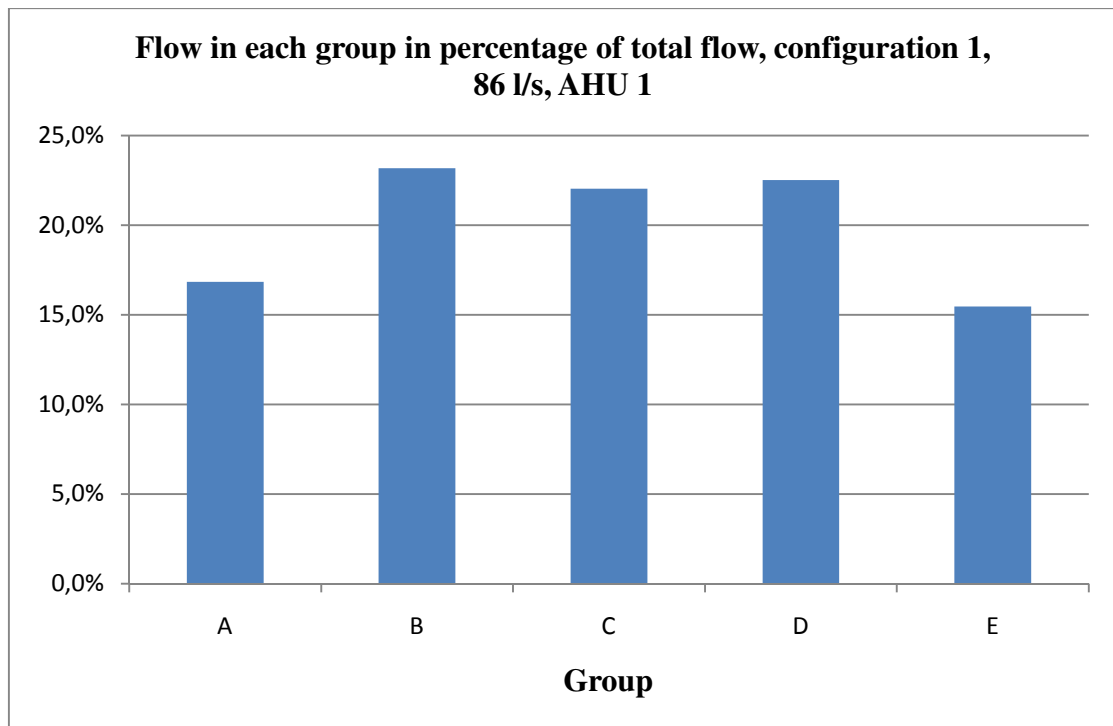

Figure 3.32 Airflow distribution for configuration 1 for the high-flow case in AHU 1. The distribution is more even than it is for the low-flow case in Figure 3.30.

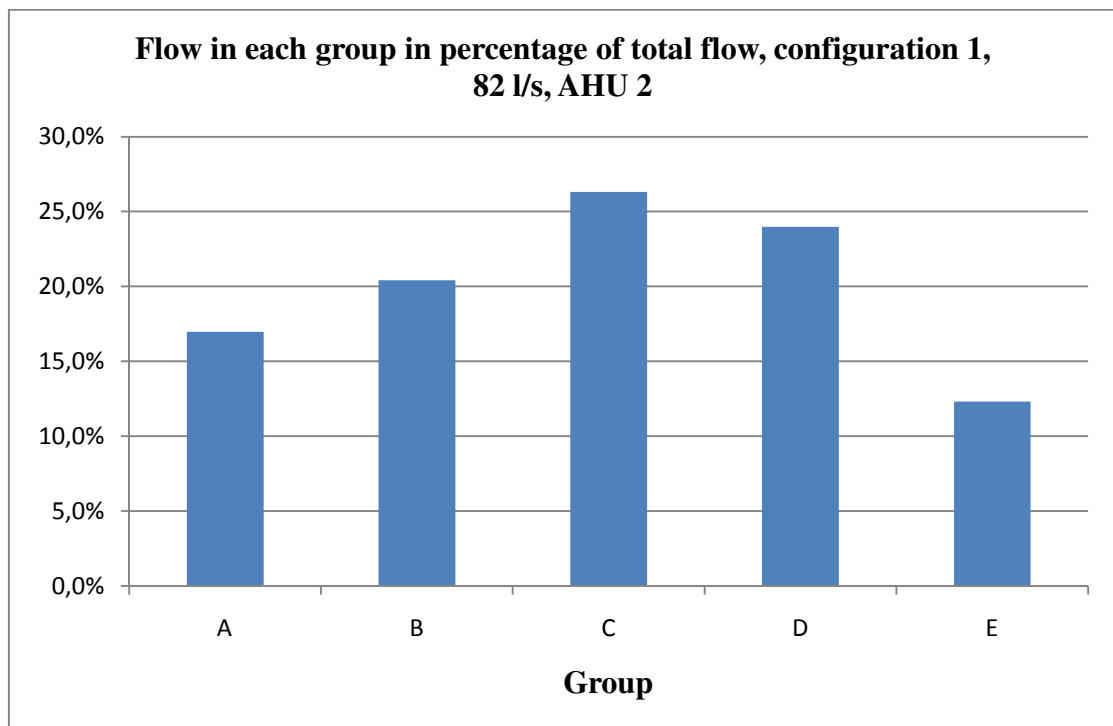

Figure 3.33 Airflow distribution for configuration 1 for the high-flow case in AHU 2.

Configuration 2

In order to force more air to the outer channel groups, D and E, two cardboard air guides was inserted below the exhaust of the fan as illustrated in Figure 3.34. The

resulting airflow distributions are presented in Figure 3.35 to Figure 3.38. For the low-flow case in AHU 1, illustrated in Figure 3.35, some improvements can be found. The distribution is more evenly distributed than for configuration 1. The flow distribution for the higher flow in the same unit, presented in Figure 3.37, is similar to the distribution for the same flow in configuration 1, apart from a reduced flow in group E.

The airflow distribution in AHU 2 for both flows has taken a relatively equalized form, but there is still room for improvements especially in the high-flow case. The majority of air still runs through the middle channels and this must be handled. The thermal efficiencies can be found in Table 3.4.

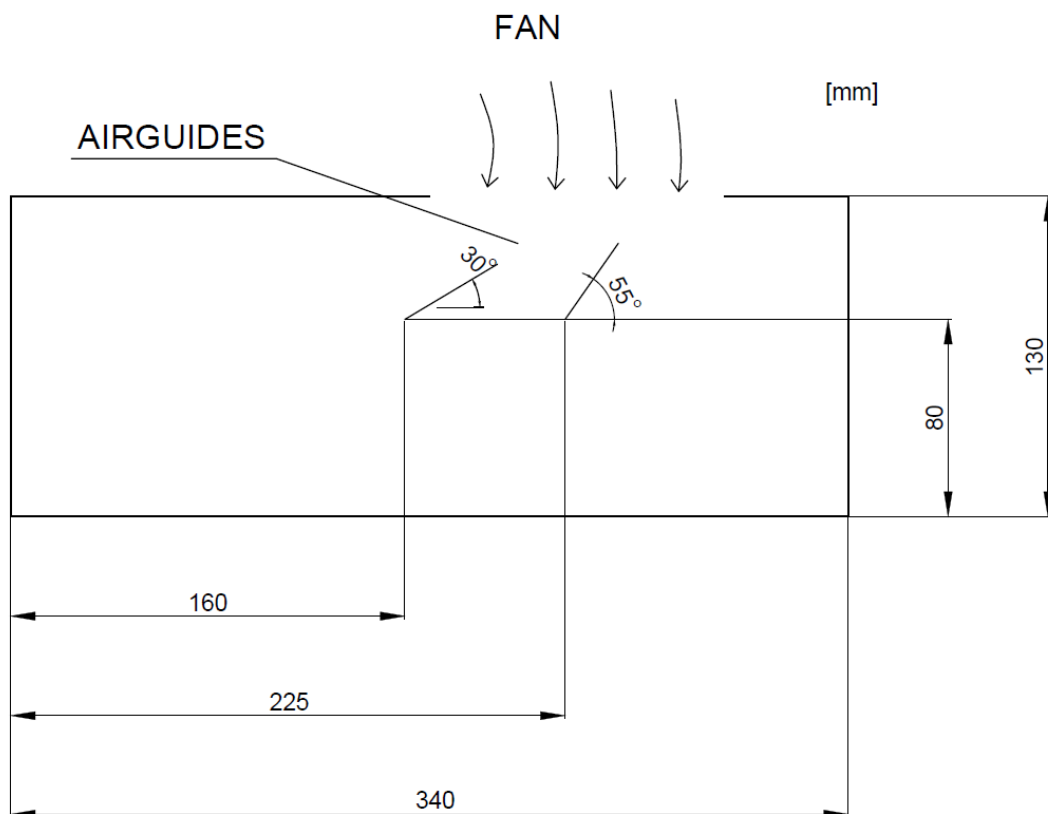

Figure 3.34 Air guide configuration 2. Two cardboard guides were used.

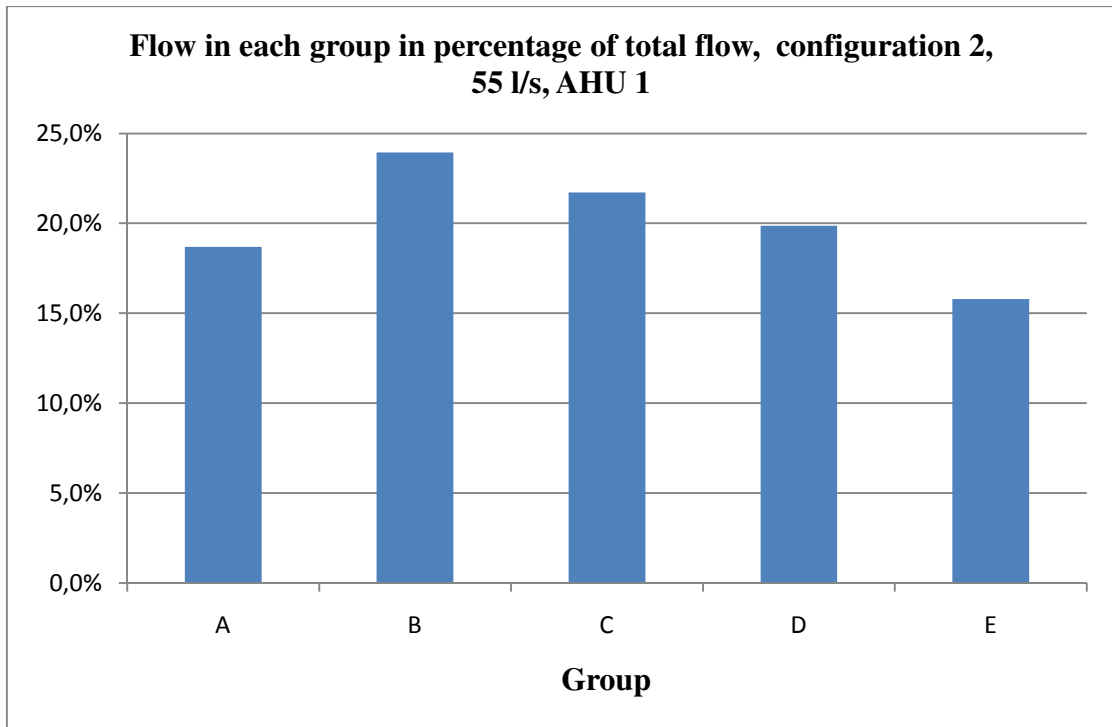

Figure 3.35 Airflow distribution for the low-flow case for configuration 2.

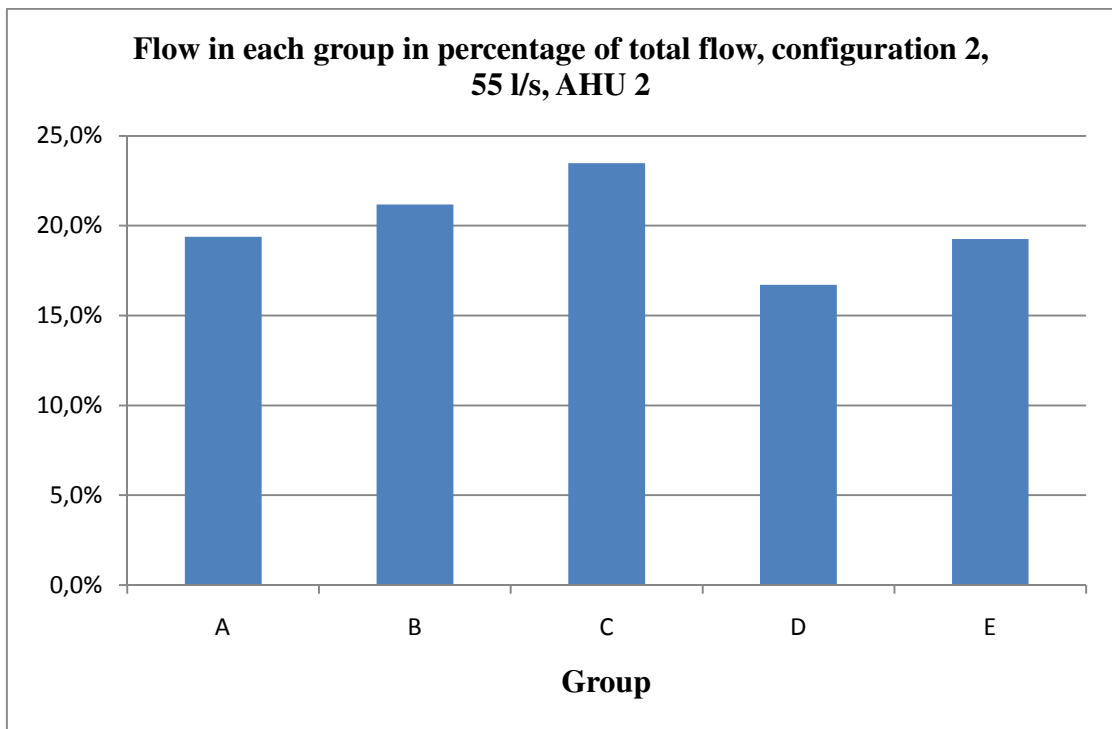

Figure 3.36 Airflow distribution for configuration 2 for the low-flow case in AHU 2.

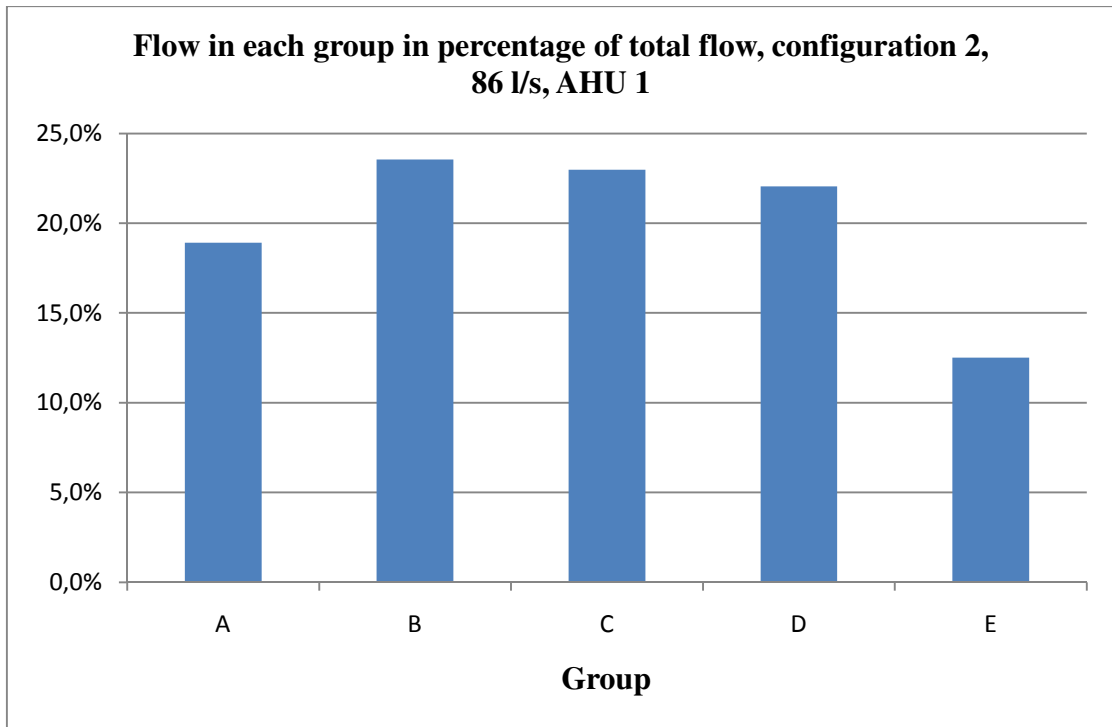

Figure 3.37 Airflow distribution for the high-flow case for configuration 2.

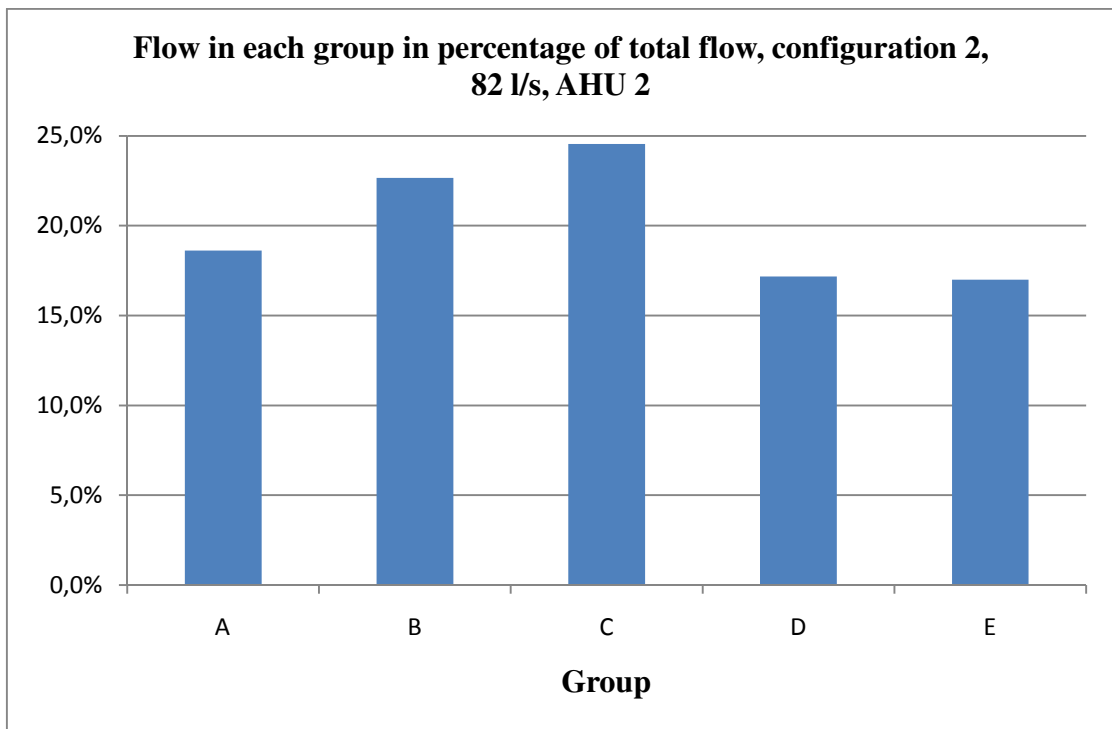

Figure 3.38 Airflow distribution for configuration 2 for the high-flow case in AHU 2.

Configuration 3

This configuration is made with three cardboard air guides located at the exhaust of the fan, one to increase the flow through group A and the other two to direct air to group D and E, as seen in Figure 3.39. The outer air guide has a decreased angle compared to configuration 2 in order to increase the airflow even more through

group E. The airflow distribution in all cases is the most equal distribution that has been measured in these tests. In AHU 1 the flow through each group is 20% of the total flow with a deviation less than $\pm 3\%$, which was considered an equal enough distribution. In AHU 2 the distribution is almost as even as for AHU 1. This distribution is more focused to group E. The resulting thermal efficiencies are presented in Table 3.4.

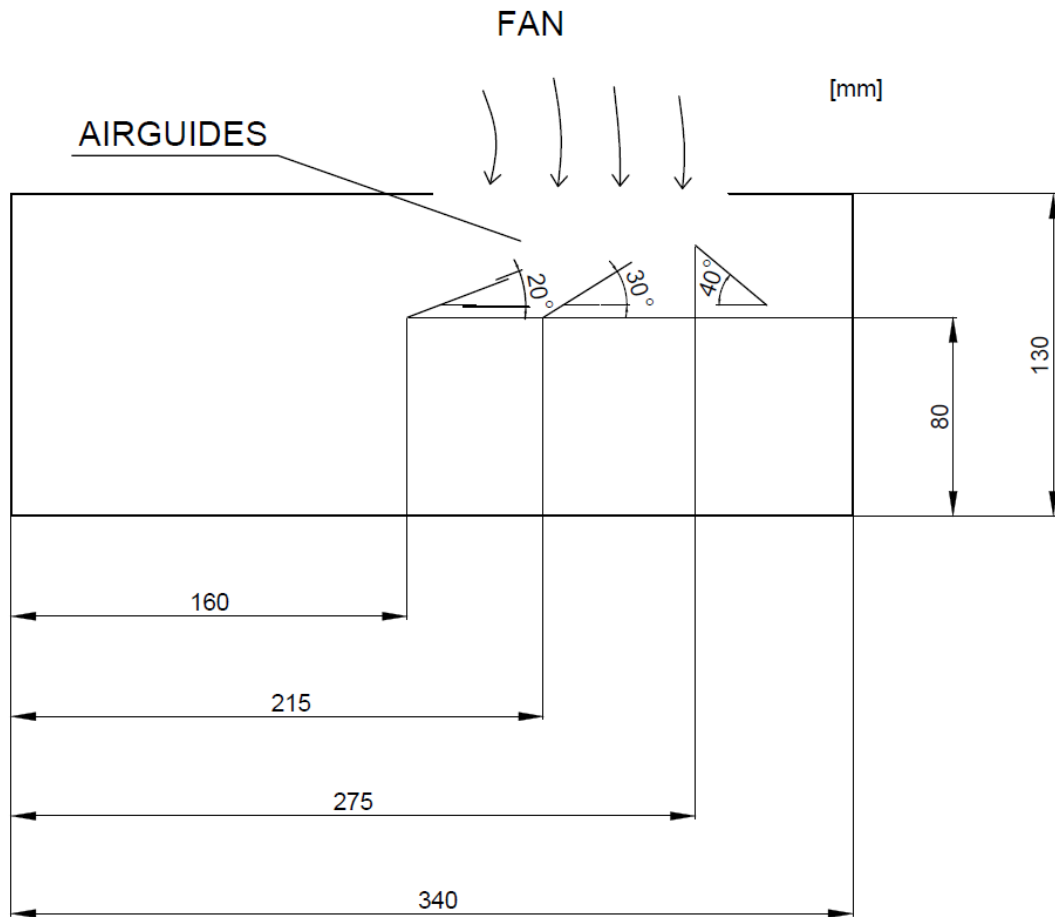

Figure 3.39 Air guide configuration 3. Three cardboard guides were used.

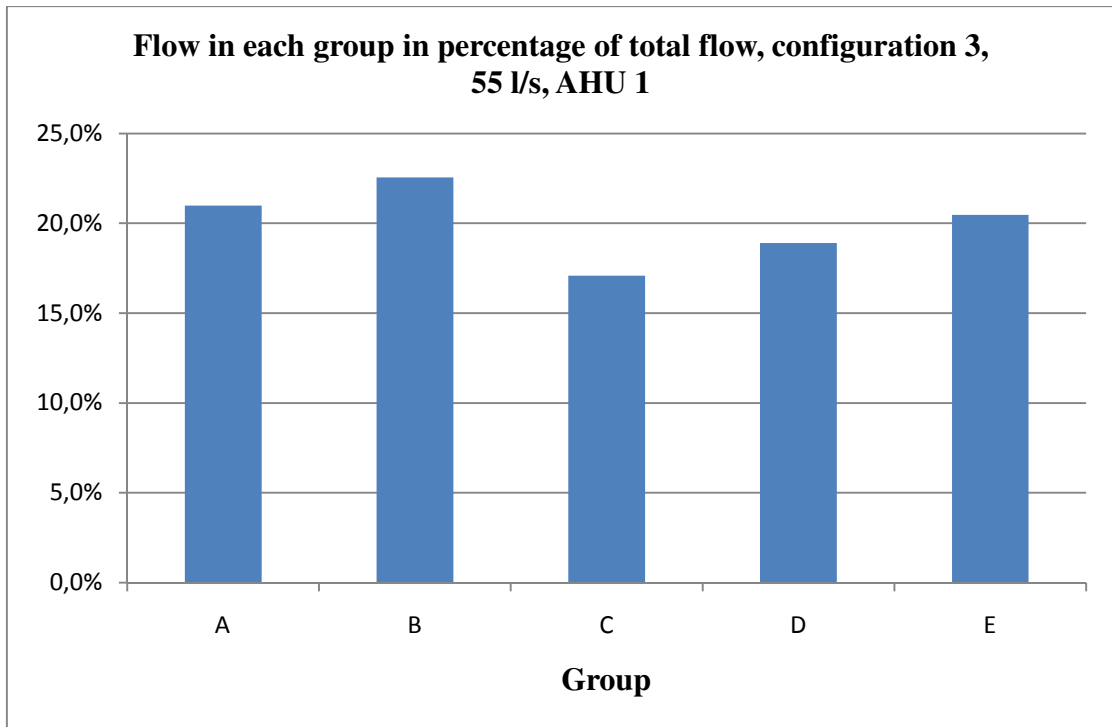

Figure 3.40 Airflow distribution for the low-flow case for configuration 3.

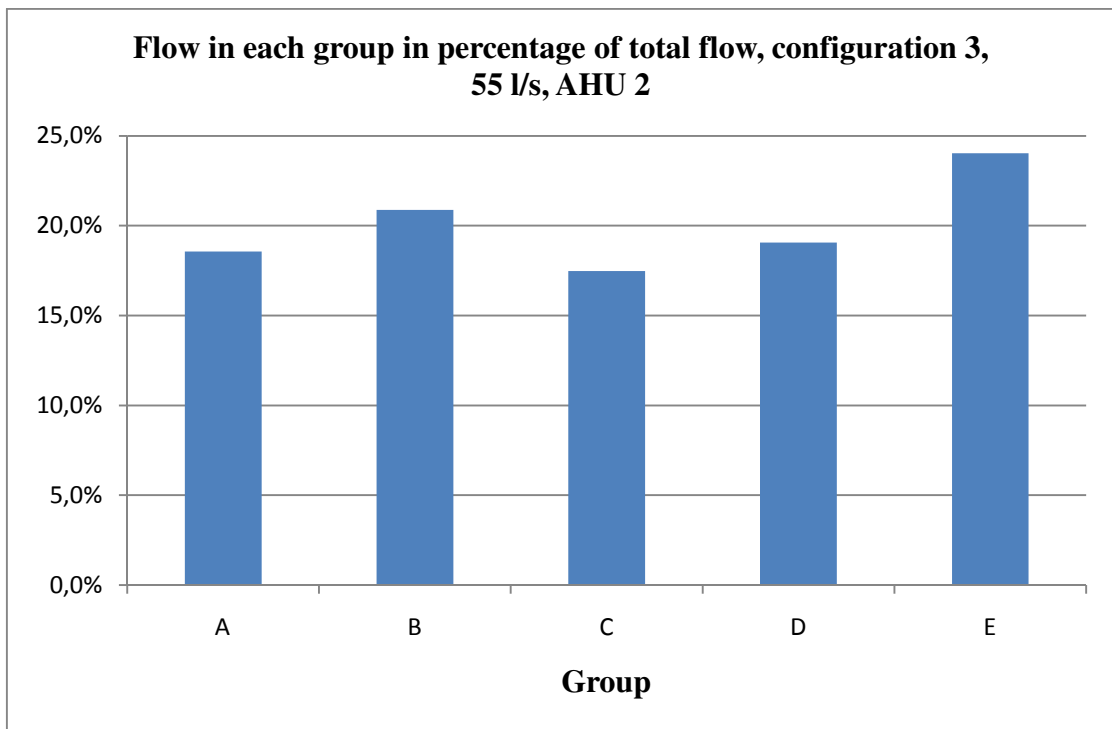

Figure 3.41 Airflow distribution for configuration 3 for the low-flow case in AHU 2.

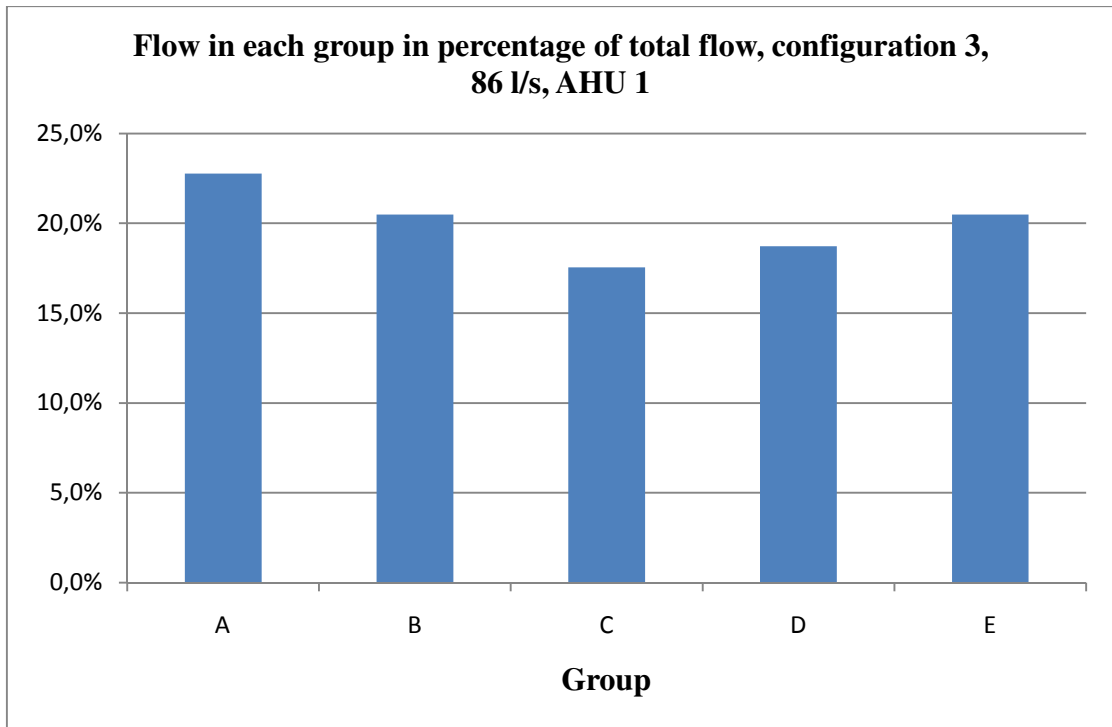

Figure 3.42 Airflow distribution for the high-flow case for configuration 3.

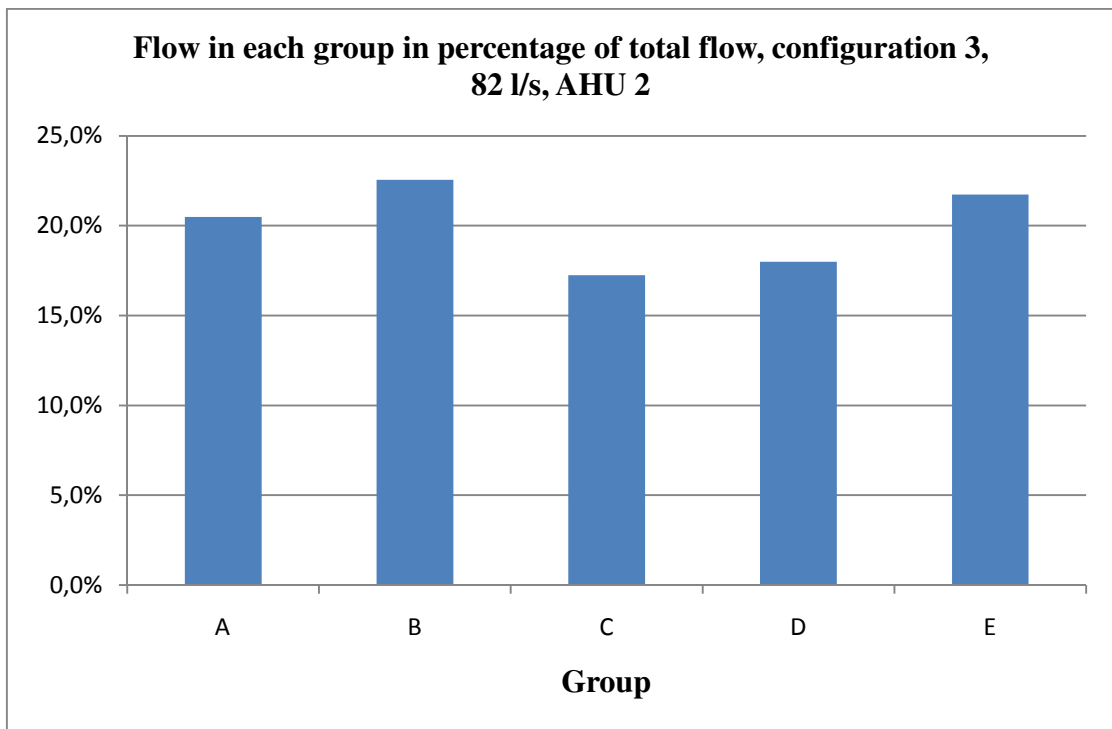

Figure 3.43 Airflow distribution for configuration 3 for the high-flow case in AHU 2.

Table 3.4 Thermal efficiencies for the three configurations of air guides. For configuration 2 the thermal efficiency was higher for the higher flow. The thermal efficiencies for AHU 2, no guides and configuration 3, is based on measurements carried out during night-time when the outdoor temperature is low which generates a lower thermal efficiency than for the measurements carried out during warmer outdoor conditions .

	AHU 1		AHU 2	
Configuration	55 l/s	86 l/s	55 l/s	82 l/s
No guides	73.0%	74.6%	82.3%	80.8%
1	74.0%	73.4%	80.8%	77.8%
2	75.1%	76.4%	81.8%	81.0%
3	78.4%	81.0%	82.8%	81.8%

Conclusion

In Section 0 the thermal efficiency for AHU 1 is determined to 73.0% and 74.6% for the low-flow case respectively the high-flow case. The best configuration for the lower flow proved to be configuration 3 which generated a thermal efficiency of 76.6%. For the high-flow case configuration 2 returned the highest thermal efficiency. However, the result for configuration 2 may be unreliable since no other test result returns a higher thermal efficiency for the high-flow case compared with the low-flow case. If the results for thermal efficiency for configuration 2 are compared with the same case for AHU 2, the results for AHU 2 follow the pattern with a decreased thermal efficiency for a higher flow.

AHU 2 with its larger heat transfer area returns thermal efficiencies of 82.3% for the low flow and 80.8% for the high flow. These values are higher than for both configuration 1 and 2 but not for configuration 3. The thermal efficiencies for the case with no guides and with configuration 3 are based on temperatures measured during one night. Since the thermal efficiencies for configuration 1 and 2 are based on measured temperatures during half an hour, the uncertainty of the results might be larger for these cases. Also these values were measured during day-time when the outdoor temperatures were higher than for the temperatures measured during the night. How the thermal efficiency depends on the outdoor temperature is described in Section 2.4.

Configuration 3 is possibly a proper choice for both flows. This configuration returns the most even airflow distribution and should consequently provide the highest thermal efficiency according to the theory in Section 3.5. The results in this section verify that the theory is also applicable in reality.

For AHU 2 the thermal efficiency increase is not as evident as it is for AHU 1. In Section 3.5 it is shown that the airflow distribution is relatively even compared to the corresponding distribution for AHU 1. This might depend on a higher pressure drop through the denser heat exchanger, which lets it work in the same way as a diffuser. Therefore, it might be more difficult to improve the airflow distribution and changes will also have smaller influence on the resulting thermal efficiency. Consequently, it

might not be as useful to mount air guides for this type of heat exchanger. It seems as an already high thermal efficiency can be difficult to improve to a greater extent.

3.7 Energy usage of air handling unit

The air handling unit requires energy input to function and to fulfill its purpose. The parts that need electricity in the air handling unit are the fans and the heater. The heater is shut off in our measurements, as a heat input from the heater would confuse the thermal efficiency measurements of the heat exchanger. Therefore, the fans are the only units in use. Their power demand depends on its efficiency, the pressure drop and the required air volume flow, according to equation (2.26).

Aim

The energy usage of the air handling unit is essential information to have as it determines the operative costs of the unit. This test aims therefore to determine the unit's power usage during operation. It should also be measured for different air guide configurations and airflows to observe any differences. In addition, the specific fan power should be determined according to equation (2.25).

Material

The material used was AHU 1, AHU 2 and the power meter Esic PM498.

Method

While measuring the efficiency over night, was the power use continuously measured by the power meter. It also measured the total energy consumption and time during the test, which is the necessary input data to calculate the average power use. The test was performed at both high- and low flow, without any airguides and with airguide configuration 3. All tests were also done on both air handling units.

Result

Values for the specific fan power for different cases are presented in the following table. The values increase when the flow is increased or air guides inserted.

Table 3.5 Specific fan power without any air guides and with air guide configuration 3. The energy consumption increases when using air guides.

	AHU 1		AHU 2	
Configuration	55 l/s	86 l/s	55 l/s	82 l/s
No guides	1.07	2.16	1.01	1.76
3	1.08	2.20	1.02	1.94

The corresponding power consumption is presented in Table 3.6.

Table 3.6 The power use, W , for the different cases. These values are used to determine the specific fan power values in Table 3.5.

	AHU 1		AHU 2	
Configuration	55 l/s	86 l/s	55 l/s	82 l/s
No guides	58.6	186.2	55.3	144.1
3	59.5	189.4	56.1	158.9

Conclusion

The specific fan power depends on the power use and the airflow flowing through the fan, according to equation (2.25). Recall that the specific fan power should be lower than $2.0 \text{ kW}/(\text{m}^3/\text{s})$ for a supply and exhaust ventilation system (Boverket 2011). This is almost fulfilled for all cases, according to Table 3.5.

According to Table 3.5 is the specific fan power increased not only at larger airflows, but when using air guides. The reason for the greater specific fan power values is probably due to larger pressure drops. The pressure drop is related to the airflow according to equation (2.28) and implies a larger airflow a larger pressure drop. The fans are constructed to keep the airflow at the specified level independent of how large the pressure drop is. Therefore is the rotational speed, and the power use, automatically increased when the resistance is increased, i.e. by air guides or larger airflow.

According to Table 3.5 is the increase in specific fan power, for AHU 1, when inserting air guide configuration 3 not of considerable size. Especially not at the low flow case, where the specific fan power increase is less than 1 percentage, or about 1 W increase in power usage, according to Table 3.6. The downside with the increased specific fan power is the increased operative costs of the air handling unit. An increase of the power use of 1 W will result in an annual increase of the energy consumption of 8.76 kWh. The increase in power use is, as may be seen in Table 3.6, greater in the high flow case. However, the air guide configuration 3 results in a higher thermal efficiency, according to Table 3.4, and hence saved energy. The effect of this increase is discussed further in Chapter 5.

AHU 2 consists of a denser heat exchanger than AHU 1 and should therefore have a greater specific fan power, as a denser heat exchanger probably has a larger pressure drop. Nevertheless, Table 3.5 shows results that are in contrary with this reasoning. According to our measurements is the specific fan power lower for AHU 2 than AHU 1. The reason for this is probably that the fans in the different air handling units have different efficiencies. As a result, the specific fan power results for the two air handling units may not be compared with each other. However, the increase when inserting air guide configuration 3 is still visible for AHU 2.

4 Uncertainties in results

When performing practical experiments it is of importance to be aware of how sure the test results are depending on type of equipment used. Therefore there is a need to determine the influence of each measured value on the final result. These uncertainties are evaluated according to the GUM-method (Joint Committee for Guides in Metrology (JCGM), 2008). This method is based on an assumption that the measured values follow a normal distribution and varies thereafter. As in most equations used in this master thesis, each calculated value is dependent on more than one measurement. Therefore, it is necessary to calculate a combined uncertainty where all contributions are taken into consideration. If x is a combined function of (r, s, t) the uncertainty of this function can be written

$$u_x = \sqrt{\left(\frac{\partial x}{\partial r} u_r\right)^2 + \left(\frac{\partial x}{\partial s} u_s\right)^2 + \left(\frac{\partial x}{\partial t} u_t\right)^2} \quad (4.1)$$

This equation will return an uncertainty on the form $x \pm ku_x$ where k is the covering factor. The covering factor depends on the desired probability that the real x is within the interval. To get a probability, or confidence level of 95.5% k is set to 2 and for a confidence level of 68.3% it can be set to 1 (Sohlström, 2007). The uncertainties calculated in this master thesis will be calculated with a 95.5% confidence level.

The accuracies of the measuring equipment are presented in Section 3.1.1, which will be the basis of the calculations in this chapter.

Table 4.1 Uncertainties of the final results calculated for some representative airflows for AHU 1. The uncertainties of the velocities are given in both actual velocities but also in percentage of the total flow as it is presented in diagrams in Chapter 3.

	Depends on	ku
Thermal efficiency [%]	$t_{s,1}, t_{s,2}, t_{e,1}$, location of temperature sensor	Low flow: $\pm 8.7\%$ High flow: $\pm 7.7\%$
SFP [W/(m ³ /s)]	$\Sigma W_t, \Delta P$	Low flow: ± 120 W/(m ³ /s) High flow: ± 140 W/(m ³ /s)
Velocities [m/s]	v	Low flow: ± 0.014 m/s $\pm 0.2\%$ High flow: ± 0.052 m/s $\pm 0.4\%$

5 Auxiliary heating demand

Heat recovered in a heat exchanger does not cost anything, why the thermal efficiency should be as high as possible. The heating demand left after heat recovery has to be taken care of by an auxiliary heater.

There are usually temperature demands on the supply air to a building, in order to heat, cool or just having a comfortable indoor climate. At cold outdoor conditions, for instance during the winter, is a high temperature lift required to reach the supply air temperature demand. This is achieved by the air handling unit where the heat exchanger and heater are located. The heater is put to work when the supply air temperature still is colder than the demand after it has passed the heat exchanger. This is only the case during a limited number of hours during the year.

The auxiliary heat input by the heater has, in contrast to the heat transferred in the heat exchanger, a price. How large heat input that is required by the heater depends on the thermal efficiency of the heat exchanger, the temperature demand of the supply air and the size of the airflow. The heater can either be transferring heat by hot water or pure electricity, where a heat pump or a district heating system can supply the heater with hot water. A hot water heater consumes less electricity than what an electric heater does, as a heat pump has a greater heat output than input. The air handling units in this master thesis have been equipped with electrified heaters, but a hydronic one is optional.

5.1 Duration diagram

The temperature distribution at a specific place may be presented in a duration diagram. In such diagram is the average temperature value of every hour during the plotted, hence 8760 values creating a diagram representing the climate at the location. Therefore, the duration diagram is unique for every place. However, an approximation of the diagram can be done with Hallén's equation, if the annual mean temperature is known. It is defined as

$$\begin{aligned}
 t(h) = & (h - 4380)(3.9 - 0.086t_{year})0.001 + t_{year} \\
 & + \left(h \frac{1 + \frac{(8 - t_{year})}{586}}{8300} \right)^{38} - \left(\frac{1550}{700 + h} \right)^3 \\
 & + 1.5 \left(\frac{t_{year}}{8} \frac{1200}{500 + h} \right)^2 \cos \left(\frac{900 - h}{585} \right)
 \end{aligned} \tag{5.1}$$

If this equation is plotted for different annual mean temperatures a duration diagram is received according to Figure 5.1. The duration diagram is used to determine the air handling unit's heating demand. The auxiliary heating demand can with this diagram be calculated, provided the annual mean temperature, the efficiency of the heat exchanger, the size of the airflow, the supply and indoor temperatures are known. When this information is known, the case may be shown in the duration diagram, according to Figure 5.2.

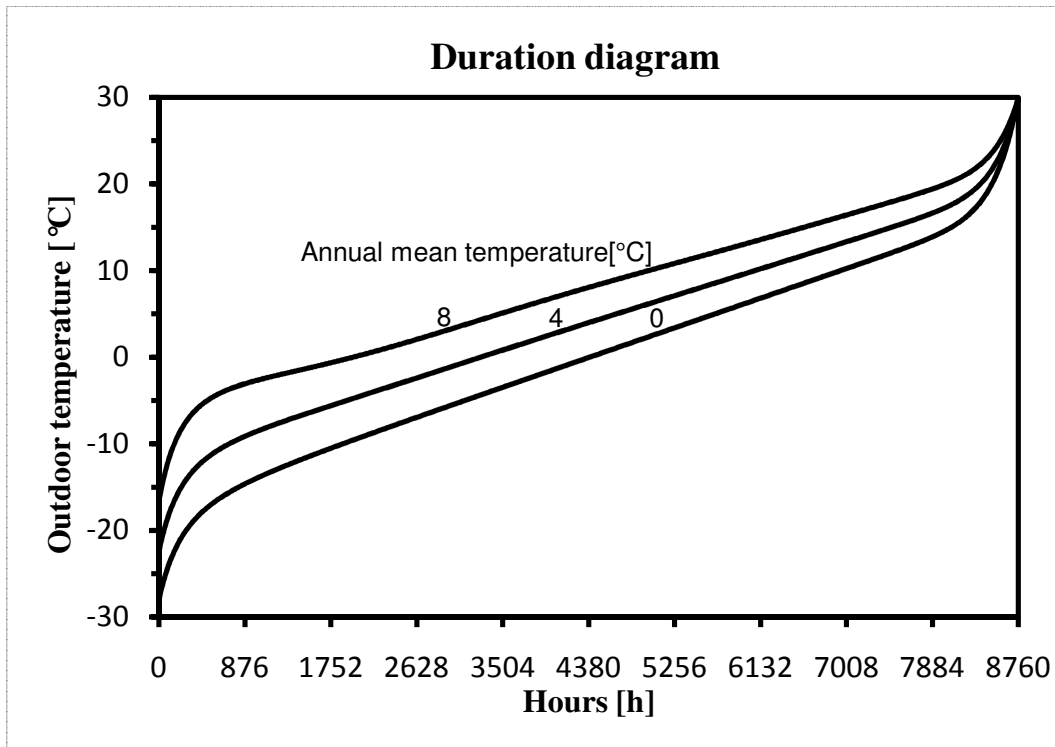

Figure 5.1 Duration diagram according to Hallén's equation with different annual mean temperatures.

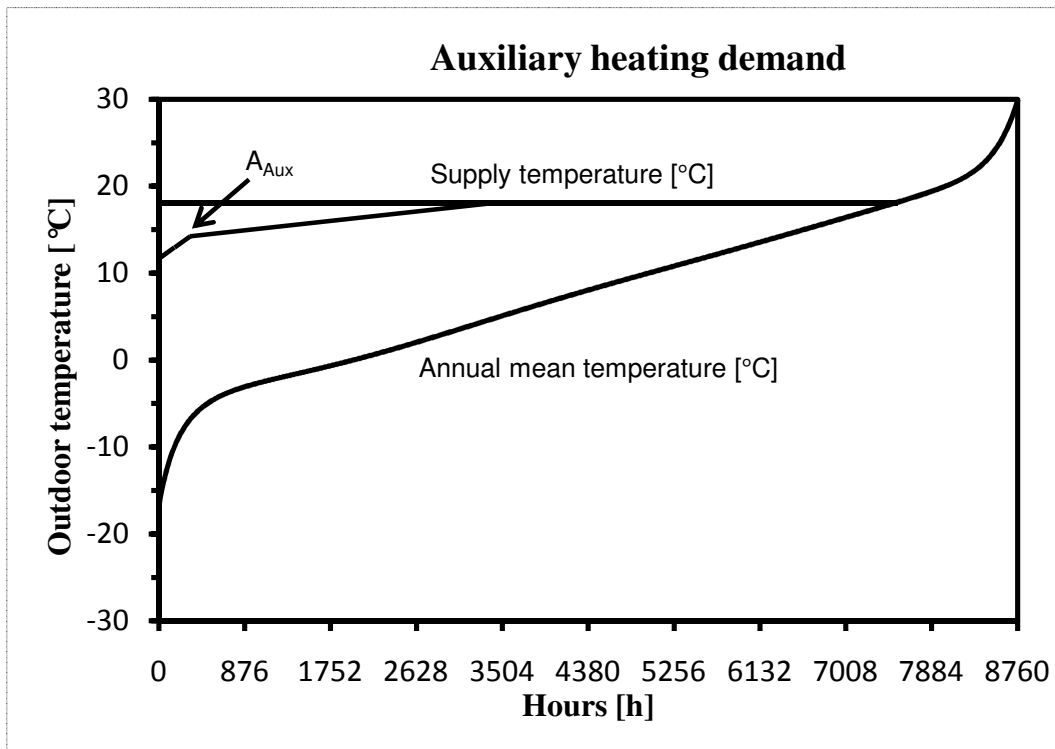

Figure 5.2 The energy needed for the heater is calculated by first determining the corresponding area in the duration diagram. The supply temperature is 21°C while the annual mean temperature is 7°C.

The area, A_{Aux} , is then used to determine the auxiliary heating demand. It is calculated as

$$Q_{Aux} = \dot{V} \rho c_p A_{Aux} f_{temp} f_{hours} \frac{\tau}{8760} \quad (5.2)$$

5.2 Energy savings

If the thermal efficiency is increased is the area, A_{Aux} , decreased and then also the the heating demand Q_{Aux} . A simple calculation of how the efficiency affects the auxiliary heating demand has been done for a case with a constant supply air temperature of 18°C and an indoor temperature of 21°C. Both airflows were set to 55 l/s. The annual mean temperature was chosen to 7°C, which is representative for Gothenburg (Svenska Meteorologiska och Hydrologiska Institutet, 2011). The results are presented in the following table where the amount saved energy is shown. The energy savings are calculated as the decrease in auxiliary heat when the thermal efficiency is increased from 70%.

Table 5.1. Energy savings when the thermal efficiency of the heat exchanger is increased, with input data as described above.

Thermal efficiency [%]	Auxiliary heat [kWh]	Saved energy [kWh]
70	1078	-
72	913	165
74	793	285
76	654	424
78	524	554

The table above shows that an increase of the thermal efficiency results in energy and costs savings. The savings may even be larger if, for instance, the airflows are increased or the annual mean temperature is decreased. However, the increased thermal efficiency in our case had the downside that the specific fan power for the fans was increased, according to Table 3.5. The increase in power consumption was almost none in the lowflow case whereas it was greater in the highflow case, according to Table 3.6.

Table 5.2 shows how much energy that may be saved each year, for AHU 1, when air guide configuration 3 is used. The measured thermal efficiencies in Table 3.4 for AHU 1 are used to calculate the decreased auxiliary heating demand. The temperatures used are the same as used for Table 5.1 and the increased operative energy are calculated with respect to increased power use in Table 3.6.

Table 5.2 Saved energy on an annual basis in AHU 1 when using air guide configuration 3 compared to no air guides. In the low flow case is the thermal efficiency raised from 73% to 78.4%, whereas it is increased from 74.6% to 81% in the high flow case.

AHU 1	Decreased auxiliary heat [kWh/year]	Increased operative energy [kWh/year]	Saved energy [kWh/year]
55 l/s	365	8	357
86 l/s	643	28	615

The result shows that it is possible to save energy by using air guide configuration 3, in AHU 1. The amount saved energy may be different if the input data is altered.

The thermal efficiency is improved even more when using AHU 2 instead of AHU 1, which results in decreased auxiliary heating demand and probably saved energy during the year. However, as the power consumption for AHU 2, according to Table 3.6, most likely is irrelevant in comparison to AHU 1, due to different fan efficiencies between the two air handling units, it is not possible to determine the increased operative energy for AHU 2.

6 Conclusions

Two major modifications have been done to the product REC Temovex 400. They have been developed by discussions, experiments and theoretical studies. The first one is redistribution of air by using air guides after the exhaust fan and the other is to increase the heat transfer area in the heat exchanger.

6.1 Air Handling Unit 1

Experiments showed that the airflow was poorly distributed through the heat exchanger at the exhaust side, in AHU 1. Theoretical calculations suggested that an even distributed airflow would increase the thermal efficiency. Therefore, one of the modifications aims to improve how the airflow is distributed in the heat exchanger. The airflow at the exhaust side was distributed by the use of air guides that improved the distribution significantly. Three different air guides configurations were closer investigated and they all returned a higher thermal efficiency. In these experiments configuration 3 returned the most even airflow distribution and also the highest thermal efficiency. For the low-flow case the thermal efficiency was increased from 73% to 78.4% and for the high-flow case it was increased from 74.6% to 81.0%. A number of similar configurations were tested, creating a slightly different airflow distribution, without creating major differences in the resulting thermal efficiency. One conclusion is then that the thermal efficiency is close to its maximum possible value created by air guides and further improvements of the airflow distribution will only have negligible effect on the thermal efficiency.

It is not certain that air guide configuration 3 returns the optimal airflow distribution, but if a more even distribution should be created, more accurate measuring equipment should be used since the uncertainties of this measure method might affect the result. In addition, the test method should be developed in order to get a higher resolution of the pattern of the flow distribution. The equipment used in this test has the disadvantage of not covering the whole exhaust of the heat exchanger. If it is possible the flow through every channel should be measured in order to get the exact flow distribution.

A downside with using air guide configuration 3 proved to be the increased power consumption for the air handling unit. For the low flow case it was increased from 58.6 W to 59.5 W, while the high flow case showed an increase from 186.2 W to 189.4 W. Nevertheless, the enhanced thermal efficiency outweighs the effect of larger power consumption, according to Section 5.2.

If the use of air guides is not possible the possibility of placing the fan after the heat exchanger should be considered in order to create a more even airflow distribution in the same manner as the supply fan does. Then the heat generated over the fan cannot be utilized, but if this creates an even airflow distribution the energy saving from an increased thermal efficiency might be big enough to compensate for the lost heat gain over the fan.

6.2 Air Handling Unit 2

In AHU 2, the modification was done on the heat exchanger by increasing the number of lamellas. As a result, the width of each channel became smaller, the total heat

transfer area was increased and hence the UA-value. It should therefore transfer a greater amount of heat, compared to AHU 1. The experiments showed that the thermal efficiency was improved compared to AHU 1, probably due to the increased UA-value. Compared with the standard unit the thermal efficiency increased from 73% to 82.3% when the airflow was set to 55 l/s. Since the airflow in AHU 2 could not be raised to 86 l/s the flow was set to 82 l/s instead. This means that the resulting differences in thermal efficiencies for the high-flow case between the two units is not as easily compared.

The influence of air guides was also put to a test in this air handling unit. The airflow distribution was measured in the same manner as for AHU 1. Without any guides AHU 2 created a more even airflow distribution than AHU 1 managed to create. As for the AHU 1, the airflow distribution was better at the supply side. The same air guide configurations used on AHU 1 was applied for AHU 2. Air guide configuration 3 slightly improved the thermal efficiency, as the air guides improved the airflow distribution at the exhaust side. Air guide configuration 3 increased the thermal efficiency more for AHU 1 than AHU 2. The explanation may be that the original distribution at the exhaust side in AHU 2 was slightly better compared to AHU 1. The reason for that is probably the decreased channel width creating larger flow resistance in each channel. The air is then forced to choose other paths, creating a better distribution. As the air distribution originally was better, the increase in thermal efficiency should be smaller if the air is redistributed to a complete uniform distribution than if the distribution was poor from the beginning.

As for AHU1, the power consumption was increased in AHU 2 when inserting air guide. For the low flow case was the power increased from 55.3 W to 56.1 W and from 144.1 W to 158.9 W for the high flow. The change in thermal efficiency when using air guides was, in contrast to AHU 1, almost none. Therefore, it may not be assured that it would be beneficial to use air guides in the long run, for AHU 2.

6.3 Recommendations of further studies

The different configurations have been developed empirically. It is not certain that the proper choice in this case is the optimal solution. Other ways of increasing the thermal efficiency can also be achieved by working on the supply airflow distribution in the heat exchanger, or balancing the two airflows against each other. In Section 3.5 the airflow distribution on the supply side is presented, which is relatively even compared to the exhaust airflow distribution. This distribution can also be improved but differences in thermal efficiencies will probably be of a smaller size than for improvements on the exhaust side.

These tests have not been able to be carried out in a cold climate and the indoor air has been relatively dry. This means that the risk of freezing damages in the heat exchanger has not been investigated. The air handling unit should be tested under conditions where freezing is likely to occur. Another downside of not being able to perform test during cold conditions is that the thermal efficiency cannot be calculated as accurate as it would be if a cold climate could have been simulated. A small difference between the outdoor and room temperature means that the influence of measurement errors will be larger and affect the thermal efficiency more than it would for a larger temperature difference.

From the performed measurements it appears that the thermal efficiency increases slightly with increased outdoor temperature. With decreased temperature the density of the air increases and calculations show that a higher density of the supply air will decrease the supply thermal efficiency. Therefore if thermal efficiencies are to be compared it is of importance to compare them at similar temperature conditions. An alternative is to take the mass flows into consideration by calculating the effectiveness if values from measurements during different conditions are to be compared.

The tests have been carried out with equal supply exhaust and exhaust airflows. In reality it is common that the building is slightly underpressured in order to avoid moisture problems in walls. An underpressure in the building is reached by letting the exhaust airflow exceed the supply airflow. According to the theory this will increase the supply thermal efficiency but decrease the exhaust thermal efficiency. If investigations of possible freezing damages are to be carried out the airflows should be adjusted to reflect the reality since a higher exhaust flow will also reduce the risk for frost damages since the exhaust airstream will not reach as low temperatures as it would if the airflows were equal.

This master thesis has not evaluated the influence of different patterns of the lamellas. However, creating a turbulent airflow in the channels of the heat exchanger is important when a high thermal efficiency is sought. Therefore it could be valuable to investigate different print on the lamellas. For example, liquid-based heat exchangers often use a print called herringbone. This pattern may increase the turbulence in the channels and consequently the thermal efficiency.

As the fan efficiencies probably are different for AHU 1 and AHU 2, the power consumption may not be compared for the units. Logically, AHU 2 should have greater power consumption due to the denser heat exchanger. By using AHU 2 instead of AHU 1, the thermal efficiency was significantly improved. In order to know the possible energy savings due to the improved thermal efficiency, the increased power consumption has to be known.

7 References

Abel, E., Elmroth, A. (2007). *Buildings and Energy – a systematic approach*. Stockholm: Forskningsrådet Formas.

Abel, E., Jagemar, L., Widén, P. (1997), *Energiteknik*, Göteborg: Teknologtryck.

American Society of Heating, Refrigerating and Air-Conditioning Engineers, Inc, ASHRAE. (2004). *HVAC SYSTEMS AND EQUIPMENT*.

American Society of Heating, Refrigerating and Air-Conditioning Engineers, Inc, ASHRAE. (2005). *FUNDAMENTALS*

Boverket. (2011). *Boverkets byggregler, BBR 2008, avsnitt 9*. [Electronic]. Karlskrona, Boverket. Available: www.boverket.se [2011-02-17]

Hagentoft, C. (2001). *Introduction to Building Physics*. Lund: Studentlitteratur.

Joint Committee for Guides in Metrology. (2008). *Evaluation of measurement data - Guide to the expression of uncertainty in measurement*. [Electronic] Report. JCGM. Available: http://www.bipm.org/utils/common/documents/jcgm/JCGM_100_2008_E.pdf [2011-05-09]

Shah, R., Sekulić, D. (2003). *Fundamentals of heat exchanger design*. John Wiley & Sons, Inc. Hoboken, New Jersey.

Sohlström, H. (2007). *Osäkerhet*. [Electronic] Power-point. Stockholm, KTH, Mikrosystemteknik. Available: <http://www.s3.kth.se/mst/edu/pdf/2e1119osak.pdf> [2011-05-09]

Svenska Meteorologiska och Hydrologiska Institutet, SMHI (2011). *Normal årsmedeltemperatur*. [Electronic]. Available: <http://www.smhi.se> [2011-05-09]