

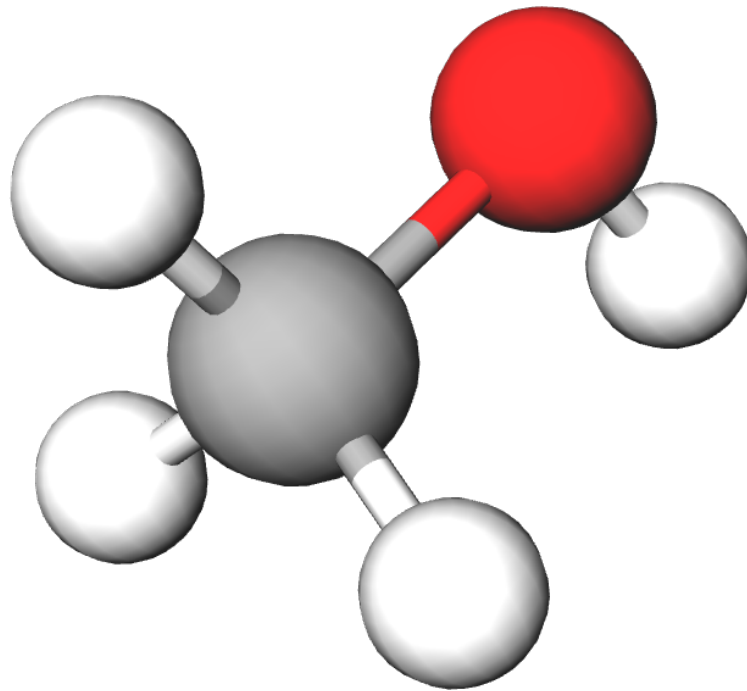

CHALMERS
UNIVERSITY OF TECHNOLOGY



Modelling Methanol Content in Condensates From a Black Liquor Evaporation Plant

A case study of the SCA Östrand pulp mill

Master's thesis in Sustainable Energy Systems

Katherine Muweke and Frida Petrusson

MASTER'S THESIS 2019:NN

Modelling Methanol Content in Condensates From a Black Liquor Evaporation Plant

A case study of the SCA Östrand pulp mill

KATHERINE MUWEKE

FRIDA PETRUSSON



CHALMERS
UNIVERSITY OF TECHNOLOGY

Department of Chemical Engineering
Division of Forest Products and Chemical Engineering
CHALMERS UNIVERSITY OF TECHNOLOGY
Gothenburg, Sweden 2019

Modelling Methanol Content in Condensates From a Black Liquor Evaporation Plant
A case study of the SCA Östrand pulp mill

KATHERINE MUWEKE

FRIDA PETRUSSON

© KATHERINE MUWEKE, FRIDA PETRUSSON 2019.

Supervisor: Mathias Gourdon, Valmet

Supervisor: Erik Karlsson, Chalmers, Department of Chemical Engineering

Examiner: Hans Theliander, Chalmers, Department of Chemical Engineering

Master's Thesis 2019:NN

Department of Chemical Engineering

Division of Forest Products and Chemical Engineering

Chalmers University of Technology

SE-412 96 Gothenburg

Telephone +46 31 772 1000

Cover: Methanol molecule.

Typeset in L^AT_EX

Printed by Chalmers Reproservice

Gothenburg, Sweden 2019

Abstract

Methanol is a by-product from the recycling of cooking chemicals from the kraft process. The substance is used as a fuel source or/and selling product at pulp mills. It is of interest to predict the quantity of methanol which can be extracted but also the content in respective condensate due to the potential re-usage in other parts of the process. This thesis work was performed together with Valmet and aimed to construct a project model which simulates the amount of methanol in condensates from a black liquor evaporation plant. SCA Östrand was used as case study plant to construct the project model. The evaporation plant uses condensate segregation, this means that the condensation zone is divided into two sections, a clean and a foul side. This gives two condensates with different fractions of methanol. To simulate the evaporation plant, a binary system of methanol-water was assumed, and vapour-liquid equilibrium (VLE) and steady state relations were utilised.

The developed project model used between one to three VLE stages on the clean side and one stage on the foul side, together with VLE stage efficiencies to simulate the condensate segregation. In the project model most of the condensates were in line with the measured data, within a 15 % range. The largest deficiency in the developed model was the surface condenser. The computed values from the surface condenser showed substantial deviations from measured data.

Utilising VLE together with steady state relations are good approximations when simulating the methanol content in black liquor condensates.

Keywords: black liquor condensate, condensate modelling, condensate segregation, evaporation, kraft process, methanol, vapour liquid equilibrium

Acknowledgements

During this thesis work we have been guided and received support from our supervisors at Valmet AB in Gothenburg. We would like to express our gratitude to Mathias Gourdon, Anders Rothelius and Olle Wennberg. Thank you for a warm welcoming and the opportunity to write this thesis. This thesis would not be possible to write without the help from SCA Östrand and we express our sincere gratitude to our contact Mattias Eriksson at SCA Östrand for the support before, during and after the sampling.

We would also wish to express our gratitude to the employees at the evaporation department at Valmet. To all of you, many thanks for your help, ideas and support on our graduate work. Lastly, we want to thank our supervisor PhD Erik Karlsson at Chalmers for the support during the entire thesis work, and our examiner Professor Hans Theliander for making this thesis possible.

Katherine Muweke and Frida Petrusson, Gothenburg, June 2019

Acronyms

CNCG concentrated non-condensable gas.

EF effect.

ICT internal condensate treatment.

LP low pressure.

MP medium pressure.

NRTL nonrandom two-liquid.

VLE vapour-liquid equilibrium.

VOC volatile organic compounds.

Glossary

Black liquor Liquor obtained from washing of cooked pulp. A high organic content mixed with used cooking chemicals.

Feed liquor Black liquor with a dry solids content of approximately 20 %, a mix of weak liquor and medium strong liquor. Used as feed into the black liquor evaporation plant.

Green liquor Liquor after recovery boiler, containing the compounds Na_2CO_3 and H_2S .

Heavy liquor Black liquor with a dry solids content of approximately 70-83 %.

Kraft process Pulping process which utilises alkali chemicals to remove organic compounds bound to the cellulose..

Live steam Fresh inlet stream from steam boiler, only water present in the steam.

Medium strong liquor Black liquor with a dry solids content of approximately 40 - 50 %.

Steam See live steam.

TUBEL An evaporator technique (used by Valmet) where the liquor is on the outside of the tubes and the heating media is on the inside.

Vapour Formed in the evaporation process from each evaporator.

Weak liquor Black liquor from the cooking step with a dry solids content of approximately 15-18 %.

White liquor Water mixed with cooking chemicals.

Contents

1	Introduction	1
1.1	Aim	2
1.2	Limitations	2
2	Background	3
2.1	Black liquor evaporation	4
2.1.1	Falling film evaporators	4
2.1.2	TUBEL technique	5
2.1.3	Multiple effect and liquor classification	5
2.1.4	Surface condenser	6
2.1.5	Black liquor condensates	6
2.1.5.1	Segregation of contaminants in vapour condensate	6
2.1.5.2	Condensate management	7
2.1.6	Stripper	7
2.1.7	Internal condensate treatment	8
2.2	SCA Östrand	9
2.2.1	Evaporation plant at SCA Östrand	9
2.2.2	Classification of condensates at SCA Östrand	10
2.2.3	Condensate segregation at SCA Östrand	11
2.3	Analysis of SCA Östrand condensates	11
3	Theory	12
3.1	Liquor flow	13
3.2	Vapour condensate calculations	14
3.2.1	Balances for clean side condensates	15
3.2.1.1	Balances for effects without internal condensate treatment	15
3.2.1.2	Balances for effects with internal condensate treatment	16
3.2.2	Balances for foul side condensates	17
4	Methodology	18
4.1	Sampling at SCA Östrand	18
4.1.1	Tests on the condensates	19
4.2	Construction of model	19
4.3	Comparison between model and samples	22
5	Results and Discussion	23
5.1	Sampling results	23
5.1.1	Concentration of methanol in outlet streams	23
5.1.2	Internal condensate treatment tests	24
5.2	The development of the project model	26
5.3	Comparison between models	28
5.3.1	Comparison of ICT modelling	29
5.4	Verification of the project model	35
6	Future work	37

7 Conclusion	38
Bibliography	39
A Schematic overview of plant	I
B Vapour-liquid equilibrium	II
C NRTL	IV
D Sampling points	V
E Model development procedure	VII
F Sample results	IX
G ICT sample results	XI
H Images of project model	XII
I Variation of ventilation flow	XIII
J Methanol flow comparison	XIV

1 Introduction

To produce pulp and paper from wood, the kraft process can be utilised. In the kraft process the inorganic chemicals NaOH and Na₂S (also referred to as cooking chemicals) are used to separate lignin and other components from cellulose [1]. The liquid used for the separation consists of cooking chemicals and water and is called *white liquor*.

The cooking chemicals can be regenerated for reuse in the process. Reuse of the chemicals is favoured due to environmental and economic considerations. The regeneration is done by cycling the chemicals and turning the so-called *black liquor* into *green liquor* and finally a non-organic white liquor is obtained. The black liquor comes from the cooking step and except a high amount of organic matter, it contains a considerable amount of water.

As mentioned above, the inorganic substances present in the black liquor are to be regenerated, which is done by combustion in a recovery boiler. It would be less efficient to combust a liquor which mainly consists of water, so for both economic and energy efficiency reasons, the water content of the liquor needs to be reduced. A high dry solids content is desirable for combustion [2]. Evaporation is applied to reduce the water content in the liquor, thus also increasing the dry solids content of the liquor [3].

It is less costly if the black liquor evaporation occurs in several steps (multiple effects) [2]. With several evaporation units, called effects (EF), the evaporated water from one effect can be used for heating the following. Using this method reduces the total heating demand for the process. Several effects are therefore used in an evaporation plant for a good energy efficiency.

During heat transfer in the effects, the heating vapour is condensed. However, the condensate does not only contain water, other substances are also present. The substances present are primarily volatile organic compounds (VOC), predominantly methanol [4]. The condensates are extracted from all the effects and can be classified differently depending on purity. The purity refers to the present amount of VOC. It is possible to obtain condensates from an effect with different amount of contaminants. This is done by segregating the condensation area into two zones. The result is two condensates which both contain contaminants, however one of the condensates has a higher content of contaminants than the other.

Since methanol is a source of fuel and it also has a monetary value for the mills [4]. It is therefore desirable to predict the distribution of methanol in the evaporation condensates for easier prediction and design of evaporation plants. Moreover, the pure condensates from the evaporation plant can be used in other parts of the pulp mill which is good from a water usage perspective.

1.1 Aim

The overall aim of this project is to improve the understanding of condensate segregation and how it affects the quality of the condensate. Furthermore, the aim is to develop a theoretical model that can simulate the methanol content in the condensates at an evaporation plant. SCA Östrand pulp mill is used as a case study and for the gathering of experimental data. The developed project model will be compared with Valmet's currently used model for the SCA Östrand evaporation plant.

1.2 Limitations

The first limitation of this thesis is that only the evaporation plant at SCA Östrand is modelled. Moreover, the super concentrator and effect 1 is not modelled, a figure of the modelled units can be seen in appendix A. Secondly, mainly methanol is of concern which is why other present substances are neglected in the model development. Thirdly, the project model is compared with Valmet's model but details from Valmet's model will not be published nor discussed due to confidentiality. Lastly, the model does not consider methanol which may be formed within effects.

2 Background

A kraft pulp mill consists of several unit operations. The general parts of such a mill are illustrated in fig. 2.1.

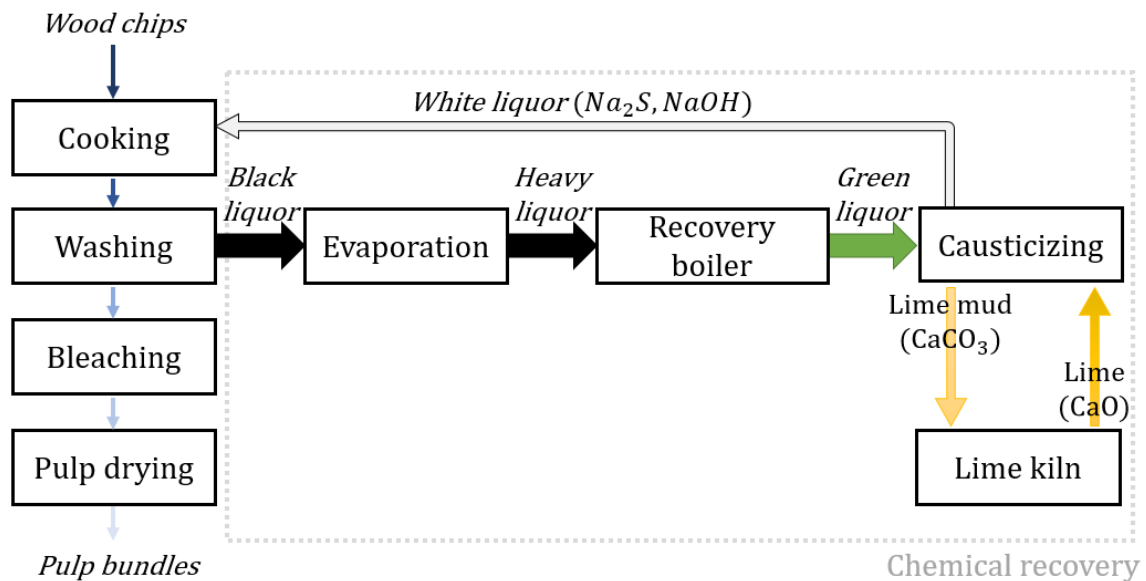

Figure 2.1: A simplified illustration of the unit operations in a kraft pulp mill, where the dotted grey marked area is the chemical recovery system [5].

The process from tree to finished pulp bundles, as seen in fig. 2.1, initiates by wood harvesting [6]. The trees are debarked and chipped to increase the contact surface before undergoing a chemical treatment with white liquor in the cooking process. After cooking, the pulp is transferred to several washings- and bleaching steps, followed by drying. Lastly, pulp bundles are either directly sold to customer, or used for own production.

During the cooking, organic components like lignin are dissolved in the white liquor which forms a black liquor. This liquor is illustrated as a black arrow in fig. 2.1 above. To achieve better economy and lower environmental impact, it is desirable to recover the energy which the organics contain and recover the alkali chemicals from the black liquor. In the kraft process, the first step to recover the chemicals is to combust the black liquor. However, for an as good heat recovery as possible, it is preferable to increase the solid content in the liquor. This is achieved by evaporation [3]. The black liquor exits the cooking process with a dry solids content of 15-18%. Exiting the evaporation plant at the mill, the black liquor has a dry solids content of approximately 70-83% and is referred to as *heavy liquor* [4].

The heavy liquor is then directed to a recovery boiler. The purpose of the recovery boiler is to remove organics and compounds that are undesirable in the pulping process and to produce process steam for the mill [3]. Moreover, a chemical recovery of NaOH and Na₂S is performed for subsequently re-usage of the cooking chemicals. From the recovery boiler a green liquor consisting of Na₂CO₃ and Na₂S is obtained, and this liquor goes through a causticizing step (see fig. 2.1) where the following

reaction occurs:

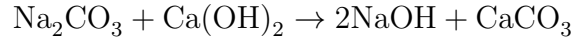

From the causticizing step the NaOH and Na₂S is collected as white liquor. The lime mud, CaCO₃ is returned as lime, CaO after causticizing in the lime kiln, by the following chemical reaction:

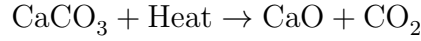

2.1 Black liquor evaporation

Modern black liquor evaporation plants consist of multiple falling film evaporators, surface condenser and a stripper [2]. In this section the fundamentals of liquor evaporation and the included units will be presented.

2.1.1 Falling film evaporators

A falling film evaporator consist of a tube or lamella heat exchanger area and a vapour-liquid separation compartment [2]. Valmet typically use tubes for the heat transfer [4]. The principle for a falling film evaporator is shown in fig. 2.2.

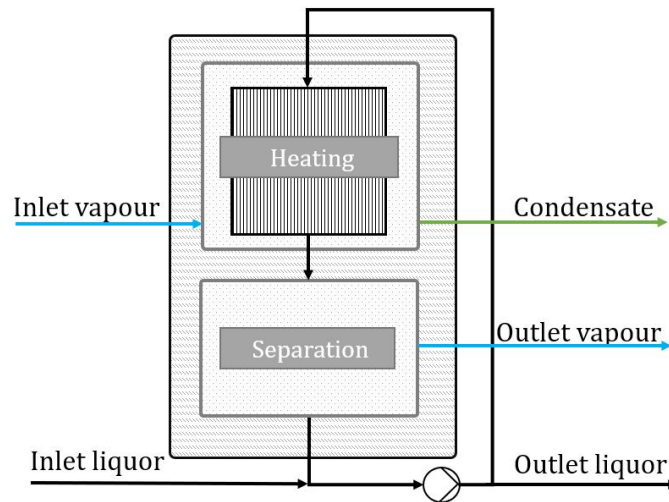

Figure 2.2: Schematic box image of a falling film evaporator. The black liquor is circulated to form a constant film within the tubes [2]. The black arrows represent the liquor flow, the blue the vapour and the green arrow is the condensate.

The black liquor is fed in the evaporator and is pumped to the top of the heat exchanger tubes together with the liquor which is recirculated. The distribution plate which is located at the top, helps to distribute the liquor evenly over the tubes and a falling film is formed [1]. As heat is transferred from the vapour at the shell side to the black liquor film at the tube side, the black liquor starts to evaporate. The evaporated vapour from the black liquor goes through a droplet separator and leaves the evaporator. The outlet vapour is then lead into the next effect's shell side and is used as heating media. The inlet vapour, which has been used as heating media, condenses and leaves the evaporator as condensate [2]. The liquor is collected at the bottom of the separation compartment and lead to the next effect or to a storage tank [4].

2.1.2 TUBEL technique

The TUBEL technique is used in tube falling film evaporators and means that the liquor film is relocated to the shell side. The black liquor in the TUBEL concentrators is fed to the outside of the tubes and steam condenses on the inside of the tubes. The technique is used when there is a high risk of fouling and/or scaling. This is usually true at high dry solids content. The technique also facilitates cleaning of the effect which needs to be done regularly since the liquor is prone to scaling and fouling. As the liquor is on the outside of the tubes, the tubes are not clogged, and the concentrators are easier to clean. [4]

2.1.3 Multiple effect and liquor classification

In evaporation plants there are several effects used to achieve the desired dry solid content. The number of effects is determined by a balance between steam economy and investment cost. The multiple effects can be arranged as such to have co-current, counter-current and mixed flow. Co-current is when the liquor and vapour flow in the same direction to the next effect which is illustrated in fig. 2.3. If co-current, the flow can be self-occurring due to pressure difference: the liquid and vapour go from an effect with higher pressure to the following effect with a lower pressure and temperature.

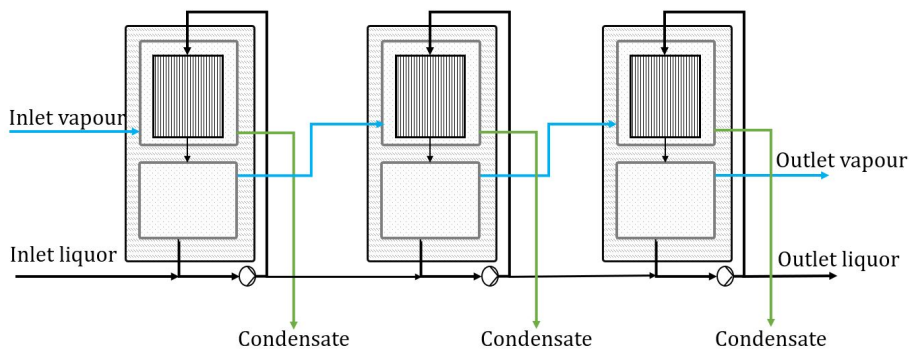

Figure 2.3: Schematic flows of co-current multiple effects. The black arrows represent the liquor flow, the blue the vapour and the green arrow is the condensate.

Counter-current is the opposite to co-current. The liquor feed enters an effect with lower pressure and is pumped to the following effect which has a higher pressure and temperature [4]. Mixed flow refers to a combined co- and counter-current flow [7].

The liquor in an evaporation plant can be classified differently depending on its dry solids content. Before the evaporation plant the solid content of the black liquor is around 15-18%, this liquor is called *weak liquor*. To avoid foaming in the evaporation process in softwood mills, the weak liquor from the cooking process is mixed with a *medium strong liquor* in a mixing tank. The dry solid content in the so called *feed liquor* is approximately 20% [2]. The liquor at the highest concentration, approximately 70-80%, is called *heavy liquor* [8].

2.1.4 Surface condenser

In an evaporation plant, a surface condenser is utilised. The surface condenser is placed after the last effect in the evaporation plant, and its purpose is to condense the vapour from the last effect and the remaining ventilation vapour from the previous effects. [4]

2.1.5 Black liquor condensates

The alkali chemicals used in the cooking process have cleaved methoxy groups in the woods and formed organic substances [2]. The degradation further continues during the evaporation process, however not as substantially as during the cooking process [4]. A part of produced organic substances are volatile and may be found in the condensate from the evaporation plant. Methanol is the main volatile organic compound found in the condensate. However, there are other compounds to recognise as well [8]. Some of the most important organic compounds in the condensates, and their characteristics are listed in table 2.1.

Table 2.1: Characteristics of the most important contaminations present in condensate.

Compound	Chemical formula	Boiling point
Dimethyl disulphide	$C_2H_6S_2$	110°C
Dimethyl sulphide	C_2H_6S	37.3°C
Ethanol	C_2H_5OH	78°C
Hydrogen sulphide	H_2S	-60°C
Methanol	CH_3OH	65°C
Methyl mercaptan	CH_3SH	6°C
Turpentine	$C_{10}H_{16}$	156°C

The characteristics of the compounds was collected from *PubChem* [9].

From table 2.1 one can see that the boiling point for most of the contaminations is lower than for water; these compounds are therefore expected to be present in the condensate. The most contaminated condensate is found close to the initial feed of the black liquor in the evaporation plant. As the dry solid content in the black liquor increases, the concentration of volatile organic compounds in the condensate decreases. This is because the volatile compounds have been evaporated and condensed upstream in the evaporation process.

2.1.5.1 Segregation of contaminants in vapour condensate

As the vapour is used as heating medium in an effect it is possible to obtain condensates with different amount of contaminants by segregating the condensation area into two zones. This is done by either an internal or external second condensation section [10]. This results in two condensates with different concentrations of contaminants, where one is cleaner than the other. The concentrations are determined by the vapour-liquid equilibrium (VLE) conditions while the amount of *clean* respectively *foul* condensates can be simplistically related to the heat exchanger area of respective zone [10], [4].

In fig. 2.4 both segregation examples have a vapour inlet at the bottom of the heat exchanger area. The vapour flows upward and a part of it condenses, thus

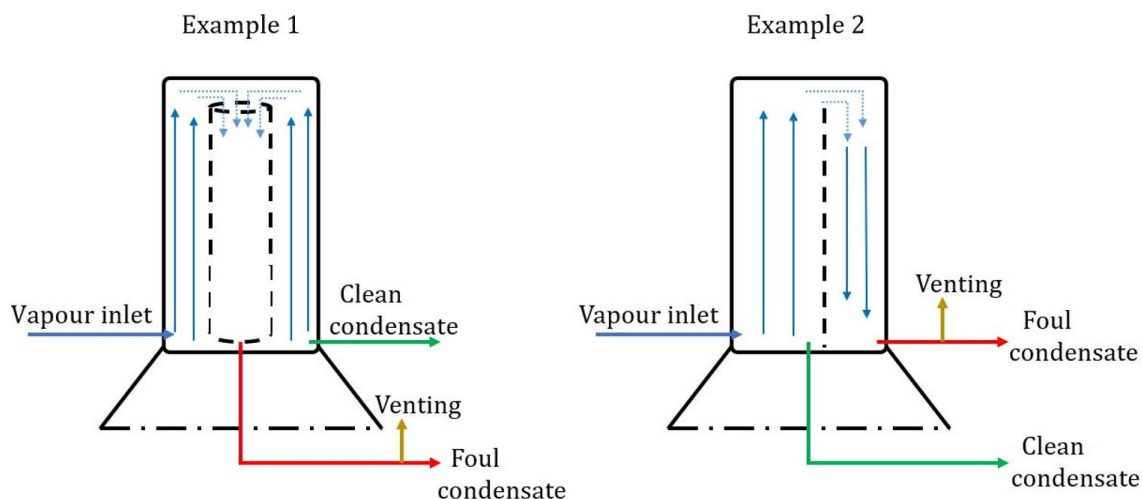

Figure 2.4: Example 1 represents internal condensate segregation by a tube while the heat exchanger area in example 2 is segregated by a plate.

the clean fraction of condensate. The remaining vapour is lead to the foul zone where a foul condensate and venting vapour is obtained with higher concentrations of contaminants due to their lower boiling point.

By diverse concentration of contaminants in the condensates, the condensates can be classified differently. There is no definite way of classifying the condensates, it varies between mills. However, an example of a condensate classification is to utilise three categories; pure, intermediate and foul condensates. Where the pure contains the lowest concentration of contaminants, and the foul condensate contains the most.

2.1.5.2 Condensate management

The liquor condensate contains a high concentration of hazardous compounds, like those in table 2.1, and can therefore not be discharged. If the condensates are classified into three groups, as mentioned above (see section 2.1.5.1), the pure and intermediate condensate can be re-used in the pulp washing process. The foul condensate can be cleaned (see sections 2.1.6 and 2.1.7) and later re-used in the same way as the purer condensates [2]. As a result, less fresh water is required in the pulping process. This is beneficial in both an environmental and economical perspective. Moreover, since the condensates have a higher temperature than fresh water, the energy economy is better when the condensates are used later in the mill.

2.1.6 Stripper

A stripper column is used to purify condensates, which carry volatile organic compounds, by vapour [2]. To transfer volatile matter from the liquid to vapour, the column is equipped with plates which the vapour rises through as it meets the liquid condensate for direct contact. In fig. 2.5 a stripper column is illustrated.

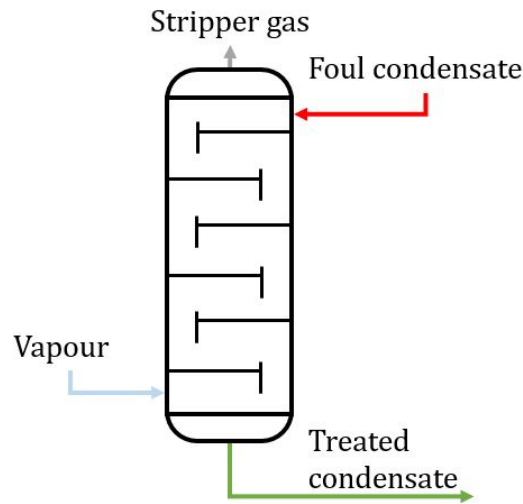

Figure 2.5: The stripper column and the streams entering and leaving the column.

In fig. 2.5, a pure vapour is inserted in the bottom of the column to be met by the down flowing foul condensate, which enters at the top. As the foul condensate flows out on the plates it is heated by the rising vapour. By heating the condensate, the volatile matter it contains will rise with the vapour. The inlet vapour captures the volatile matter in the condensate, which mainly is methanol, and leaves the column at the top as a *stripper gas*. The stripper gas is later transferred to a treatment unit. The condensate leaving at the bottom of the column, *treated condensate*, is normally classified as a pure condensate.

2.1.7 Internal condensate treatment

Another method used to clean condensates is Valmet's patented internal condensate treatment (ICT) technique. ICT is an add-in to one or more evaporator effects where some of the condensate is preheated to about the same temperature as the inlet vapour, and let in at the top in the clean zone of the heat transfer area, see fig. 2.6.

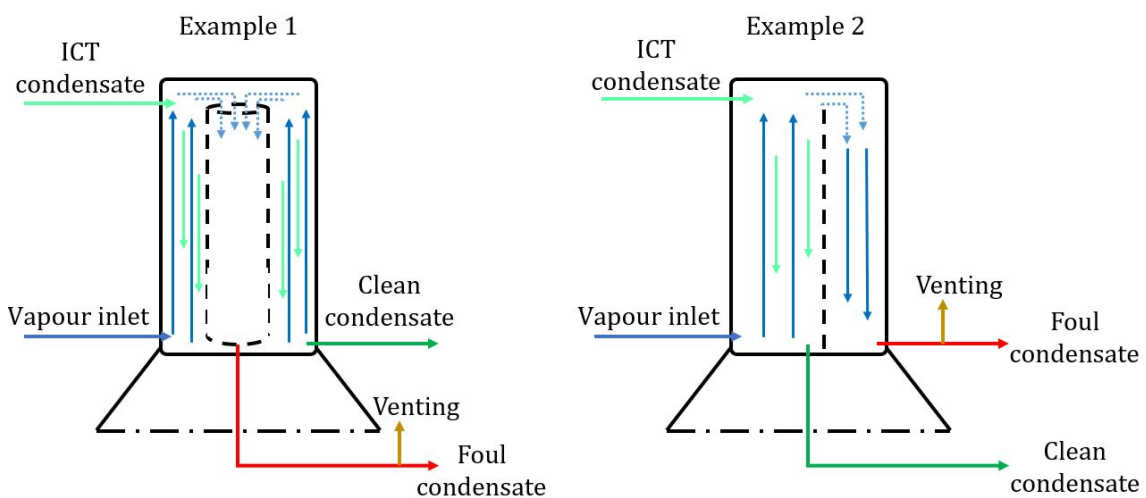

Figure 2.6: Internal condensate segregation by tube and plate with inlet condensate for internal condensate treatment.

The technique is used to reduce the methanol concentration and to increase the amount of clean condensate at a mill. A similar effect as in the stripper column is achieved. As seen in fig. 2.6 there are two examples of how the construction can be. In example 1, there is a partition tube in the middle of the top section in an effect. The condensate that shall be cleaned enters at the top and is distributed outside the central tube, the most contaminated vapour condenses within this tube. In example 2, in fig. 2.6 the top section of an effect has a partition plate instead of a tube in the middle and the function is the same as in example 1.

2.2 SCA Östrand

The case study for this thesis is performed at the evaporation plant at SCA Östrand pulp mill in Sundsvall, Sweden. The mill was commissioned in 1932. At the time, the capacity was 100 000 tonnes produced bleached kraft pulp per year [11]. Since 1932 the mill has continuously increased its production and today the capacity is 900 000 tonnes. This makes SCA Östrand the world's largest production line for bleached softwood kraft pulp [12]. The current evaporation plant at SCA Östrand has been supplied by Valmet and has the maximum evaporation rate of 1150 tonnes of water per hour.

2.2.1 Evaporation plant at SCA Östrand

The evaporation plant at SCA Östrand consists of ten falling film evaporators. The effects adopt a mixed liquor flow and a flash condenser is arranged between EF3 and 4. The evaporation plant is illustrated schematically in fig. 2.7.

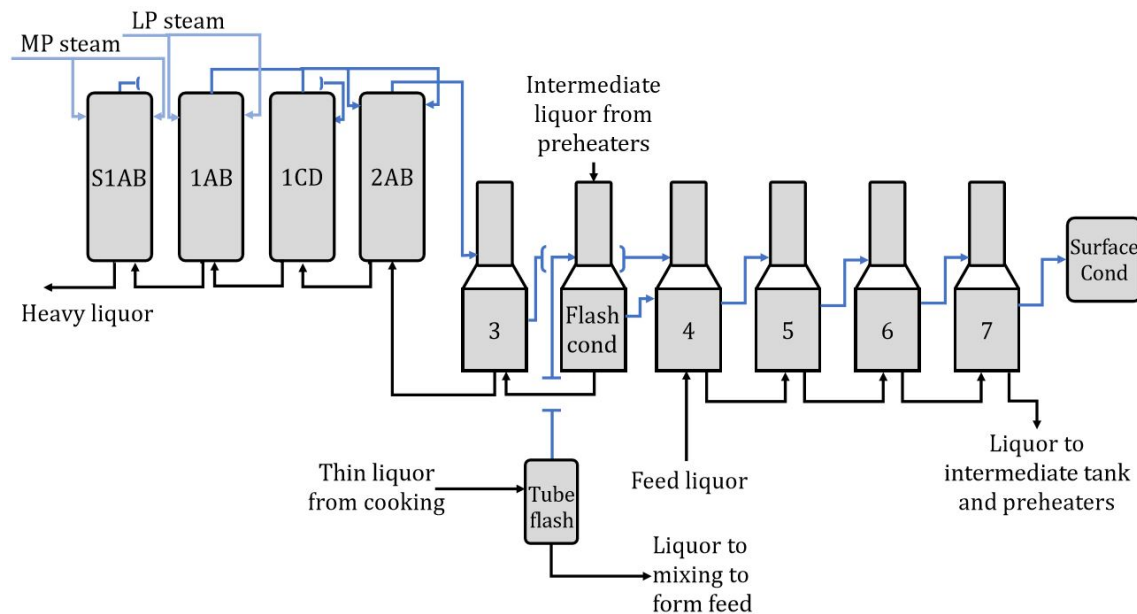

Figure 2.7: Simplistic overview of the SCA Östrand evaporation plant.

In fig. 2.7, the feed liquor enters the evaporation plant in EF4. Later it is transferred, by pressure difference, to the effects 5, 6 and 7 (co-current). The liquor is then preheated internally in EF6 and 5 and transferred to the intermediate liquor tank. After preheating it is further pumped to the remaining effects (counter-current);

flash condenser, 3, 2AB, 1AB, 1CD and the superconcentrator, S1AB, where the final dry content is reached [4]. The heavy liquor from S1AB has a dry solids content higher than 80%. The units S1AB, 1AB, 1CD and 2AB (see fig. 2.7) utilizes the TUBEL technique, while units 3, flash condenser, 4, 5, 6 and 7 are regular tubular falling film effects, as described in section 2.1.1.

The flash condenser, shown in fig. 2.7, is placed between EF3 and 4. At SCA Östrand the weak liquor is flashed after the cooking step. The resulting vapour from the flashing is used as a heating medium to further evaporate the black liquor in the flash condenser. During the heat transfer the flash vapour condenses, hence the name flash condenser. [4]

High temperatures are needed to reduce the viscosity of the black liquor, which increases together with the higher dry solids content. Medium pressure (MP) steam is used as heating medium in S1AB and low pressure (LP) steam in 1AB and 1CD. This steam may also be referred to as live steam and is steam produced in the boilers at the mill. The resulting vapour from the evaporation of black liquor in 1AB and 1CD is used as heating medium in EF2AB and goes to the stripper. The principle is the same for all effects (see fig. 2.7), where the produced vapour is used in the following effect with lower temperature and pressure. During heat transfer, the heating medium condenses as it releases heat. Thus, at SCA Östrand there are fresh steam condensates from S1AB, 1AB and 1CD and vapour condensate from the remaining effects.

2.2.2 Classification of condensates at SCA Östrand

At SCA Östrand the vapour condensates from the evaporation plant are classified into three types of condensate called A, B and C, where A is the cleanest and C the dirtiest. In fig. 2.8, the path of the condensates A, B and C in the evaporation plant is illustrated.

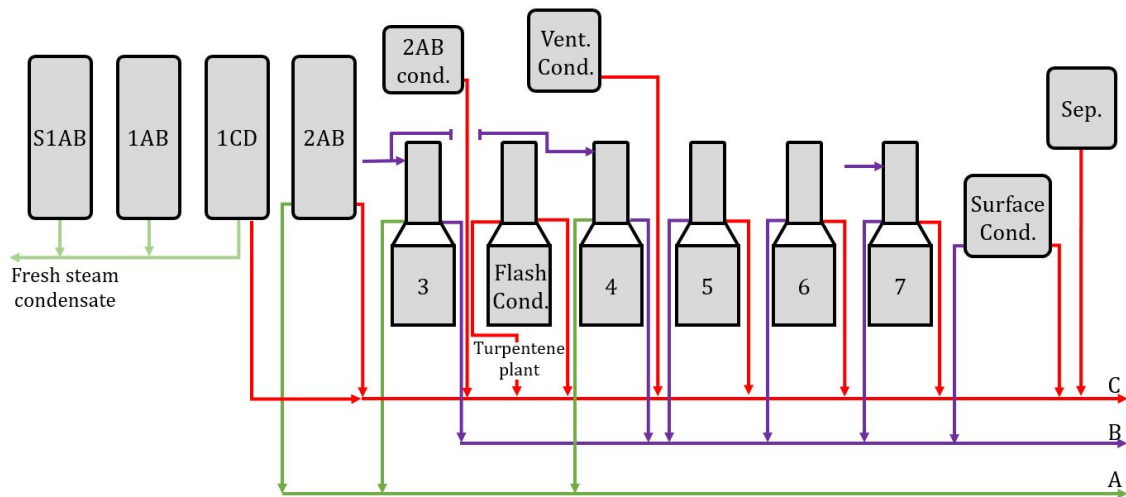

Figure 2.8: Overview of the condensate flow in the plant at SCA Östrand. The A-condensate is represented by the green, B by the lilac and C by the red lines. From S1AB to 1CD fresh steam condensate leaves separately. Furthermore, "Sep." denotes a separation tank used to flash the ventilation vapour from the surface condenser.

The A-condensate is classified as pure and can be used for washing the pulp, in mixing or for an aerated pool after heat exchange. Primarily, the A-condensate is generated in EF2AB, 3, 4 and the stripper. The B-condensate is called intermediate thus, it is not as pure as the A-condensate, nor as contaminated as the C-condensate. The B-condensate can be used in similar application as the A-condensate or in other parts of the mill. The intermediate condensate is generated from the clean side in effects 5, 6, 7 and the surface condenser. Also, it is generated on the foul side in the effects 3 and 4, and from preheating in EF5.

The C-condensate is not directly re-used in the mill because of its high content of impurities, hence it is cleaned in the stripper (see section 2.1.6) for subsequent reuse. The C-condensate is generated from the foul side in EF2AB, 5, 6, 7 and from the surface condenser. Also, C-condensate is collected from the flash condenser, ventilation condenser and separation tank [4]. For a more detailed figure of all condensate and vapour flows, see appendix A.

2.2.3 Condensate segregation at SCA Östrand

The clean and foul sides mentioned before refers to the segregation of the condensates in effects 2AB, 3, 4, 5, 6 and 7. At the SCA Östrand mill the intermediate and foul condensate are formed by internal segregation of the condensate with a partition tube. Depending on tube evaporator, the clean condensate can be classified as A- or B quality and the foul condensate can be classified as B- or C-condensate. There is however an exception made for the flash condenser at SCA Östrand where both clean and foul side condensates are classified as C-condensate due to the high amount of contaminants. This is because it is the condensate of the first flash vapour of the weak liquor.

As mentioned in section 2.1.7 the internal condensate treatment (ICT) technique can be utilised in one or several effects. At SCA Östrand the technique is used in three effects: in EF3, 4 and 7. Where the inlet ICT flow to EF3 and 4 can be changed manually and in EF7 it is set to either on or off. The inlet condensate is of B quality and as a result a bigger fraction of clean condensate is formed, more A-condensate in EF3 and 4, and more B-condensate in EF7.

At SCA Östrand an amount of the B-condensate which exits EF7 is used as ICT inlet to EF3 and 4. Following, the B-condensate created in EF3 and 4 enters EF7 as ICT inlet, and this causes the formation of a loop in the system. This can be seen in the overview of the evaporation plant in appendix A. As a simplifying and time saving measure, this loop is not considered in the design of the project model.

2.3 Analysis of SCA Östrand condensates

To model the concentration of methanol in the condensates, laboratory tests are of interest. By analysing the condensates, the project model can be validated and optimised with regards to the circumstances at SCA Östrand evaporation plant. Tests that may be of interest are to measure the concentration of methanol and in some samples, it can be of interest to test the concentration of nitrogen and sulphuric compounds. The content of nitrogen and sulphuric compounds can be used to see if samples have similar relations which can be used to evaluate samples that, for instance, are tested at another occasion or condition.

3 Theory

The condensate composition can be estimated by assuming a binary vapour-liquid equilibrium (VLE) system, meaning a mixture of vapour and liquid at equilibrium, where only two components are present; water and methanol. This is due to the low concentrations of other present substances. The VLE assumption stipulates that the equilibrium conditions are met. These are detailed in appendix B.

By assuming a water-methanol system, the relative volatility can be described by eq. (3.1).

$$\alpha = \frac{\frac{y_{\text{CH}_3\text{OH}}}{x_{\text{CH}_3\text{OH}}}}{\frac{y_{\text{H}_2\text{O}}}{x_{\text{H}_2\text{O}}}} = \frac{\frac{y_{\text{CH}_3\text{OH}}}{x_{\text{CH}_3\text{OH}}}}{\frac{1-y_{\text{CH}_3\text{OH}}}{1-x_{\text{CH}_3\text{OH}}}} \quad (3.1)$$

At low concentrations of methanol, the denominator in eq. (3.1) goes towards 1, which gives a simplification of the relative volatility, α in eq. (3.2).

$$\alpha = \frac{y_{\text{CH}_3\text{OH}}}{x_{\text{CH}_3\text{OH}}} = K' \quad (3.2)$$

Hence, α at low concentrations can be simplified to a constant value, K' . By the definition in eq. (3.2) K' is the vapour-liquid equilibrium (VLE) ratio for methanol.

To describe α and in turn also K' , the activity factor model called nonrandom two-liquid (NRTL), eq. (3.3), is used, see appendix C. Other fitting models to describe this binary system, would be UNIQUAC and UNIFAC. The respective model activity coefficients for describing the system are similar in all these models. However, the NRTL model can be extended to include electrolytes and also when two liquid phases are present [10], [13].

The VLE can be expressed as a polynomial temperature dependent equation, see eq. (3.3).

$$K' = a_{i,j} + b_{i,j}T_{sat} + c_{i,j}T_{sat}^2 \quad (3.3)$$

(Where i=methanol, j=water)

Previous studies conducted linear regression analysis of the computed α by the NRTL model and found the constants expressed in eq. (3.3) to be as shown in eq. (3.4) [4], [13].

$$K' = 11 - 0.042T_{sat} + 0.0001T_{sat}^2 \quad (3.4)$$

The dependence of saturation temperatures in eq. (3.4) is only valid at low concentrations of methanol and a temperature range within 70-120°C. This is a simplified method to estimate the vapour-liquid equilibrium. To reduce the simplification, a possible method is to account the other present substances in the mixture by "over- or underestimate" the VLE ratio. The black liquor is in fact an electrolyte. Previous studies show that the relative volatility for a water/methanol solution increases with additions of salts commonly found in black liquor [10].

Furthermore, it is not always possible to assume that vapour and liquid mole fractions are related by only thermodynamic K -values. There is also a complex influence

from geometry and design of equipment, and flow rates and flow paths of the vapour and liquid streams. The influence affects how much equilibrium is actually achieved. This can be adjusted with VLE stage efficiency, η , see eq. (3.5) [7], [13].

$$y_i = \eta K_i x_i \quad (3.5)$$

To construct a calculation model of the condensates, both the liquor and the vapour flows need to be considered. In the sections 3.1 and 3.2 equations to describe each section of an effect are defined.

3.1 Liquor flow

To represent the liquor flow in the evaporation plant, mass, component and summation balances, as well as phase equilibrium are constructed, see eqs. (3.6) to (3.9). Steady-state is assumed.

$$F = L + V \quad (3.6)$$

$$F \cdot z_i = L \cdot x_i + V \cdot y_i \quad (3.7)$$

$$K_i = \frac{y_i}{x_i} \quad (3.8)$$

$$\sum_i y_i - \sum_i x_i = 0 \quad (3.9)$$

The eqs. (3.6) to (3.9) are general equations to illustrate any system for a single flash step, where F denotes feed flow and L and V stand for outlet liquid and vapour flow.

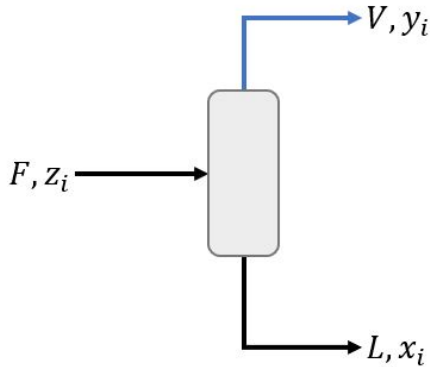

Figure 3.1: Schematics on a single flash step.

z , x and y denote fraction of species, i in respective flows. See fig. 3.1 for schematics.

To calculate the flow and methanol composition in the vapour and liquor leaving EF5, shown to the right in fig. 3.2, the eqs. (3.6) to (3.8) are used.

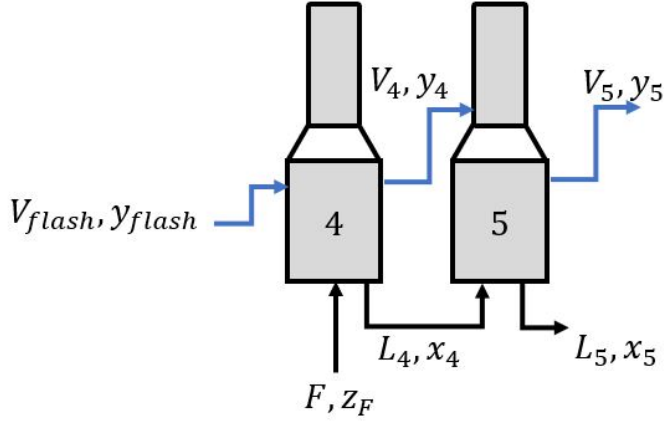

Figure 3.2: Schematics for a part of the evaporation plat. F is the feed liquor and the black arrows indicates liquor. The vapour which evaporates from the liquor in EF4 is used as heating media in EF5 where it condenses.

In general, all effects' vapour and liquor flows and methanol composition are calculated in the same way as in the case of EF5, see eqs. (3.10) to (3.12) where q refers to the effect number/name.

$$L_{q-1} = L_q + V_q \quad (3.10)$$

$$L_{q-1} \cdot x_{i,q-1} = L_q \cdot x_{i,q} + V_q \cdot y_{i,q} \quad (3.11)$$

$$K_{i,q} = \frac{y_{i,q}}{x_{i,q}} \quad (3.12)$$

However, the mass and composition balances for EF4 will differ. This is because of the vapour flow from the flash condenser does not enter the top of EF4, but is instead mixed with the liquor in the bottom of EF4, See fig. 3.2. The mass and composition balances for EF4 are as follow, eqs. (3.13) and (3.14).

$$F + V_{flash} = L_4 + V_4 \quad (3.13)$$

$$F \cdot z_{i,F} + V_{flash} \cdot y_{i,flash} = L_4 \cdot x_{i,4} + V_4 \cdot y_{i,4} \quad (3.14)$$

3.2 Vapour condensate calculations

To describe the segregation of the condensates in the effects, distillation approximation can be used to simulate the clean and foul side [10]. In fig. 3.3 the clean and foul side are illustrated.

The inlet vapour from the previous effect is labelled V_{q-1} and if ICT is connected to an effect, the inlet stream L_{ICT} is added. The clean condensate leaving the clean side in EF q , is labelled $L_{clean,q}$ and the outlet vapour from the clean side, $V_{n+1,q}$ is

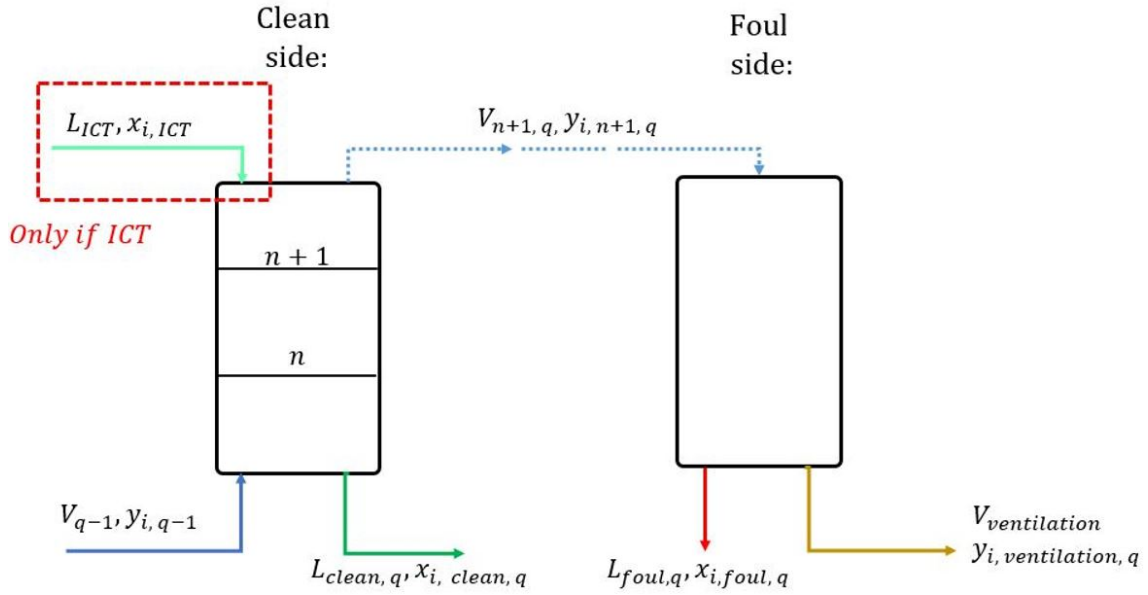

Figure 3.3: Modelling of the clean and foul side in the top compartment of the effects. The heating vapour, V_{q-1} entering effect q , is the vapour evaporated in the previous effect $q - 1$. The vapour $V_{n+1,q}$ leaving the clean side is the inlet vapour to the foul side.

the inlet to the foul side. The condensate leaving the foul side is labelled $L_{foul,q}$. The clean side is modelled with $n + 1$ equilibrium steps and the foul side with one.

To model the clean and foul side the mass eqs. (3.15) and (3.16) listed below are utilised.

$$L_{condensate,q} = V_{q-1} - V_{ventilation,q} \quad (3.15)$$

$$L_{condensate,q} = L_{clean,q} + L_{foul,q} \quad (3.16)$$

Where the clean and foul refers to if the condensates go on the outside or inside of the partition tube which was pictured by example 1 in fig. 2.6. $L_{condensate,q}$ is therefore the total amount of condensate in EF q . Furthermore, the ventilation stands for the ventilation on the foul side, see fig. 3.3. For each equilibrium step n in the distillation approximation, the relation eq. (3.17) can be used.

$$y_{i,n,q} = K_{i,n,q} \cdot x_{i,n,q} \quad (3.17)$$

3.2.1 Balances for clean side condensates

In this section the equations to illustrate the clean side of an effect will be described.

3.2.1.1 Balances for effects without internal condensate treatment

The following balances are only valid when there is no inlet ICT flow to the effect.

$$L_{clean,q} = L_{condensate,q} \cdot f_{clean,q}, \quad (3.18)$$

where f_{clean} denotes the fraction of condensate to the clean side in an effect. From knowledge about eq. (3.18) all inlet and outlet streams from the clean side can be

set by eq. (3.19). Moreover, the mass- and component balances, eqs. (3.20) to (3.24) over the clean side stages can be written.

Total mass balance for the clean side in EF q :

$$V_{q-1} = V_{n+1,q} + L_{clean} \quad (3.19)$$

Total component balance for the clean side in EF q :

$$V_{q-1} \cdot y_{i,q-1} = V_{n+1,q} \cdot y_{i,n+1,q} + L_{clean,q} \cdot x_{i,clean,q} \quad (3.20)$$

Mass balance for stage n :

$$V_{n,q} + L_{clean,q} = V_{q-1} + L_{n+1,q} \quad (3.21)$$

Component balance for stage n :

$$V_{n,q} \cdot y_{i,n,q} + L_{clean,q} \cdot x_{i,clean,q} = V_{q-1} \cdot y_{i,q-1} + L_{n+1,q} \cdot x_{i,n+1,q} \quad (3.22)$$

Mass balance for stage $n + 1$:

$$V_{n+1} = V_n - L_{n+1} \quad (3.23)$$

Component balance for stage $n + 1$:

$$V_{n+1,q} \cdot y_{i,n+1,q} = V_{n,q} \cdot y_{i,n,q} - L_{n+1,q} \cdot x_{i,n+1,q} \quad (3.24)$$

See fig. 3.3 for an illustrative figure of the balances on the clean side.

3.2.1.2 Balances for effects with internal condensate treatment

In comparison to section 3.2.1.1 eqs. (3.18) to (3.20), (3.23) and (3.24) will not be valid when there is an ICT flow to an effect. To model the ICT, which the effects 3, 4 and 7 at SCA Östrand have, the equations differ somewhat from the ones mentioned in section 3.2.1.1. Instead the concerned equations need to take the ICT flow into consideration. The following mass- and component balances eqs. (3.25) to (3.29) are set up to model the ICT unit.

$$L_{clean,q} = L_{condensate,q} \cdot f_{clean,q} + L_{ICT,q} \quad (3.25)$$

Total mass balance for the clean side in EF q with ICT:

$$V_{q-1} + L_{ICT,q} = V_{n+1,q} + L_{clean} \quad (3.26)$$

Total component balance for the clean side in EF q with ICT:

$$V_{q-1} \cdot y_{i,q-1} + L_{ICT,q} \cdot x_{i,ICT,q} = V_{n+1,q} \cdot y_{i,n+1,q} + L_{clean,q} \cdot x_{i,clean,q} \quad (3.27)$$

The n -step is calculated according to eqs. (3.21) and (3.22). However, for the $n + 1$ -step the eqs. (3.28) and (3.29) are used instead of the eqs. (3.23) and (3.24). Mass- and component balances for stage $n + 1$ with ICT:

$$V_{n+1} + L_{ICT,q} = V_n - L_{n+1} \quad (3.28)$$

$$V_{n+1,q} \cdot y_{i,n+1,q} + L_{ICT,q} \cdot x_{i,ICT,q} = V_{n,q} \cdot y_{i,n,q} - L_{n+1,q} \cdot x_{i,n+1,q} \quad (3.29)$$

The foul side is not affected by the ICT.

3.2.2 Balances for foul side condensates

In contrast to the clean side, the foul side is assumed to consist of only one equilibrium stage. This is because the vapour and liquid are continuously co-current from inlet till outlet and thus at equilibrium at outlet. The mass- and component balance in eqs. (3.30) and (3.31) can be used to simulate the foul side.

$$V_{n+1} = V_{ventilation} + L_{foul} \quad (3.30)$$

$$V_{n+1} \cdot y_{n+1} = V_{ventilation} \cdot y_{ventilation} + L_{foul} \cdot x_{foul} \quad (3.31)$$

4 Methodology

The different project parts are outlined in chronological order in fig. 4.1.

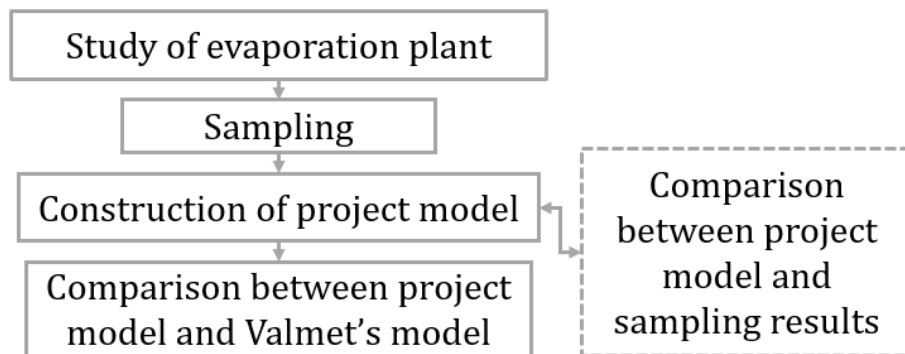

Figure 4.1: Overview of the project methodology.

As shown in fig. 4.1, the project was initiated with study of the evaporation plant, followed by sampling at the plant. The project model was then developed by comparing calculated values with the data from sampling. Lastly the project model was concluded with a final comparison with Valmet's calculation model and the sampling data.

4.1 Sampling at SCA Östrand

The case study sampling took place at SCA Östrand during a three-day period, after which the samples were analysed at an external laboratory. The condensate samples were used to map the pathway of the methanol over the evaporation plant. The results of the sampling were used to test the designed project model, this is described in detail in section 4.3.

As the operation of the evaporation plant was stable, several condensate samples from the evaporation plant were collected. At the first day of sampling, the amount of evaporated water was 610 t water evaporated/h. During this sampling there was a higher amount of medium strong liquor in the feed liquor due to temporary process conditions. During the second day of sampling the plant was running at an evaporation rate of 910 t water evaporated/h and the feed liquor was more normal in the previous case. The evaporation plant was thus operating at 53% and 79% of maximum plant capacity (1150 t water evaporated/h). Information of the sampling points can be seen in appendix D.

After collecting the samples at the evaporation plant the second day, the ICT-flow was changed by process control for EF3 and 4. The four ICT-flow changes of EF3 and 4 are shown in table 4.1 below.

Table 4.1: The name of the ICT tests and the corresponding ICT-flow entering EF3 and 4 respectively.

Name of test	Settings of ICT-flow	
	Effect 3	Effect 4
ICT normal	130 m^3/h	130 m^3/h
ICT 1	200 m^3/h	60 m^3/h
ICT 2	260 m^3/h	0 m^3/h
ICT 3	60 m^3/h	200 m^3/h
ICT 4	0 m^3/h	260 m^3/h

The different settings seen in table 4.1 are meant to give an overview of how to construct the ICT-units in the project model, see section 4.2. The total ICT flow was consistently 260 m^3/h . This was because the flow was set by the operational load.

The ICT in EF7 was tested during the third day. The plant load was the same as during the second day. The testing was done by turning off the ICT flow into EF7 completely. This was because the flow only has on and off as possible settings. The sampling points for testing the ICT in the effects 3, 4 and 7 can be seen in appendix D.

4.1.1 Tests on the condensates

All samples were transported to an external laboratory (MoRe Research Örnsköldsvik AB) where the concentration of methanol was measured for each sample. Sulphuric compounds and nitrogen were also measured on specific samples. The used methods for analysis are standardised and shown in table 4.2.

Table 4.2: Methods used by MoRe for analysis of samples.

Analysis of:	Unit	Method
Total nitrogen	mg/L	SS-EN 12260
Total sulphur, Schöniger	mg/L	SCAN-N 35
Methanol	mg/L	KA 80:314

A large majority of the sample points were only sampled once per evaporational load. Since there were not several double samples taken, the sampling result is not impeccably trustworthy. All reliability depends on that the analysis is correct. It is therefore important to note that errors may occur during sampling and analysis of samples. However, they are a good indication. The two samplings were compared to see similarities or relations to see how reliable the given data was.

Details about which analysis that were performed on each sample can be seen in appendix D.

4.2 Construction of model

To construct the model to predict the amount of methanol in the condensates, process data from SCA Östrand plant was collected. The process data were averages

of the measured values during the condensate sampling. The sampling results and process data which were chosen to be used for the project model development were those from the higher operating load (910 t/h). The choice was made due to the case being closer to maximum capacity.

Process data which could not be collected due to it not being measured at SCA Östrand, e.g. the saturation temperature and amount evaporated water in each effect and fraction of clean area in the condensate segregation, was instead simulated by inserting the process conditions at which the sampling took place, in Valmet's design model.

The amount of methanol entering the evaporation plant was estimated by using laboratory results and condensate flow measurements. Assuming most of the methanol ends up in the condensates, the methanol content in the all condensates leaving the evaporation plant (TotA, TotB and TotC) also constitute the methanol entering the plant. In reality, a certain amount of methanol is also formed during the heat treatment of the liquor in effects S1AB and 1. Additionally, not all methanol is able to condense. The methanol which is not able to condensate ends up in the concentrated non-condensable gas (CNCG) system. There is also a small amount left in the liquor, it is assumed to be less than 5% [4]. This was later accounted for in the model. The sample results for the ICT flows were also used as input because of the difficulty of simulating the B-condensate loop which can be seen in appendix A.

The collected and simulated process data was together with the estimated methanol amount used as input data for the development of project model, as shown in fig. 4.2.

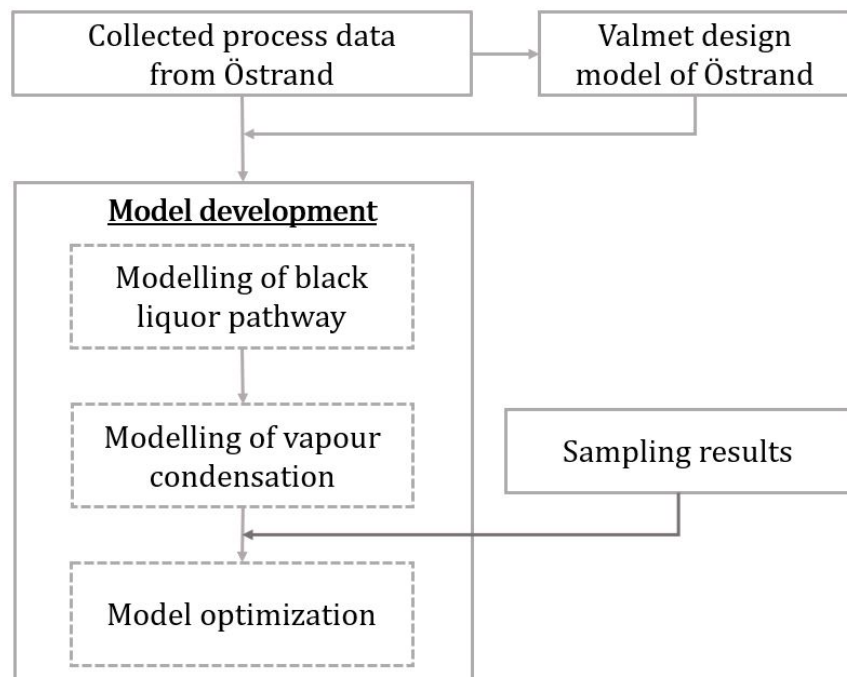

Figure 4.2: Overview of the method used for model development.

The input data served to provide all flows, inlet methanol and necessary VLE ratios. From this, methanol concentrations in both liquor and vapour could be estimated.

The development of the model began with modelling the black liquor pathway, see

fig. 4.2. Meaning from feed in EF4, following the liquor flow to EF7, and continuing the flash condenser until EF2. EFS1AB and 1 were not simulated. During this part of model development, the VLE ratios were overrated with 5 %, due to black liquor being an electrolyte [10], [4].

The methanol content in the evaporated vapour was estimated by modelling the black liquor pathway. This content is directly related to the amount of methanol found in the condensates. As discussed in section 3.2, the number of equilibrium steps used to model the clean side are 1-3. The number of steps were determined from literature [10] and trial-error tests when later comparing with the laboratory results, see section 4.3.

The surface condenser is modelled similarly. The difference lies in the foul side. All ventilation vapours from previous effects enter the foul side directly and does not pass the clean side first (fig. 4.3).

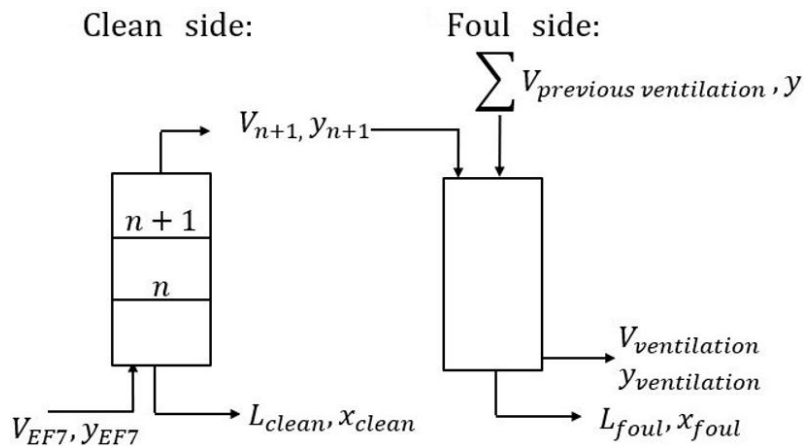

Figure 4.3: Schematics for the surface condenser where all previous ventilation vapours enter the foul side.

It also implies that all necessary effects need to be simulated prior to modelling the surface condenser. It is otherwise not possible to compute the sum and content of all ventilation vapours.

The model was then optimised by comparing the computed values with the laboratory results. The optimisation measures that were tried was: Amending the amount of ventilation vapour in each effect and modifying the VLE ratios for both clean and foul side in each effect.

The project model was developed in the software MS Excel. For a detailed procedure of the modelling, see appendix E.

The modelling first used the amount of methanol which was calculated from condensate sample results as input. However, to account the methanol which did not end up in the condensates during sampling, the input was increased until the simulated methanol content in the condensates corresponded to the sample amount. The input methanol also needed to correspond to the sum of the amount in the condensates, liquor and ventilation of the surface condenser. Meaning that the inlet amount to system must equal to all outlet content of the system. Important to note is that as

the the amount in the ICT flows was specified as input, the same amount needed to be subtracted from the content in the simulated condensates. This to be consistent with the system boundary of the evaporation plant.

4.3 Comparison between model and samples

Both the optimised project model output, and Valmet's design model were compared with sample results. The data compared were the estimated methanol concentrations and the estimated amount (kg/h) of methanol. The comparison was done in graphs, tables and relative differences were calculated. Both models were then tried for the lower plant load case to see how well the models corresponded to the sample results and to verify the project model.

5 Results and Discussion

In this section the results from the samplings, the designed project model and a comparison with the model used by Valmet will be presented.

5.1 Sampling results

The results from the samplings performed at SCA Östrand are presented in sections 5.1.1 and 5.1.2 below. Compilation of sampling data can be found in appendix F.

5.1.1 Concentration of methanol in outlet streams

The concentration of methanol, sulphuric compounds and nitrogen from the major outlet streams of the evaporation plant from the samplings can be seen in tables 5.1 and 5.2. Based on the sample results the amount of methanol in the condensates could be estimated. There should therefore be at least the estimated amount in the black liquor entering the evaporation plant.

Table 5.1: Composition of outlet streams from the evaporation plant, results from sampling the 26th February, 610t/h evaporated.

Name	Nitrogen (mg/L)	Sulphur (mgS/L)	MeOH (mg/L)
Tot A	13	8.7	240*
Tot B	5	7.96	260
Tot C	137	140	4730
MeOH in condensates (kg/h)			632

* Value out of normal range, probably an incorrect measurement of sample. Replaced with 60 mg/L.

Table 5.2: Composition of outlet streams from the evaporation plant, results from sampling the 27th February, 910t/h evaporated.

Name	Nitrogen (mg/L)	Sulphur (mgS/L)	MeOH (mg/L)
Tot A	5	2.73	60
Tot B	5	2.05	350
Tot C	130	200	4250
MeOH in condensates (kg/h)			901

During the estimation of methanol in the condensates the concentration of the A-condensate in table 5.1 was replaced with the concentration from (table 5.2), due to an A-condensate concentration of 240 mg MeOH/L being unreasonable. This will affect the input during the verification of the project model. Furthermore, the verification itself will be influenced, making the results of it uncertain.

The reason why nitrogen and sulphuric compounds was measured was primarily to see if there would be resemblance between the samples from the two days of

sampling. When comparing the tables 5.1 and 5.2 some results have similarities, and some have not. Also, when looking at the full sampling from the first day (610 t/h) when compared to the second day (910 t/h) in appendix F, several values were incompatible. The differences between concentration for the two samplings were not consistent or predictable and since the evaporation rate of the first sampling was almost half about the maximum capacity the conditions were not ideal. A possible explanation could be the higher fraction of medium strong liquor which was mentioned in section 4.1.

The 610 t/h case is hence only used for verification of the project model, the ICT tests were not performed during this day. Moreover, the model optimisation measures were performed on the 910 t/h case, and the same model settings were then tested for the 610 t/h case.

5.1.2 Internal condensate treatment tests

To design the project model, the effects with ICT were varied during sampling as mentioned in section 4.1. The flow in EF3 and 4 was changed by process control (see table 4.1) as the flow into EF7 was turned on and off. The change of flow into EF3 and 4 resulted in the concentration of methanol shown in table 5.3.

Table 5.3: The concentration of methanol(mg/L) measured from the ICT tests in EF3 and 4. The "a" and "b" denotes the classification of the condensates and clean and foul side in the effects.

Name	Effect 3			Effect 4			Total A-cond. ⁺ (kg/h)
	ICT inlet* (kg/h)	3a (mg/L)	3b (mg/L)	ICT inlet* (kg/h)	4a (mg/L)	4b (mg/L)	
ICT Normal	130	65	2130	130	85	1780	33
ICT 1	200	75	2690	60	50	1240	29
ICT 2	260	80	3120	0	35	690	31
ICT 3	60	35	1290	200	95	2040	31
ICT 4	0	20	500	260	110	2170	39

* The inlet methanol concentration was constant at 300 mg/L to both effects.

⁺ Total amount of methanol in the A-condensate from EF3 and 4. The concentration from sampling was multiplied with the corresponding flow.

As seen in table 5.3, the concentration of methanol in both clean and foul condensate increased due to the added methanol from the inlet ICT flow. This may be considered as negative, however the ICT condensate is stripped of methanol, and a higher amount of clean side condensate is obtained. The inlet into the condensation area in the effects still consists of top fed B-condensate and the vapour from the previous effect. This means that the inlet vapour from previous effect cleans the inlet ICT condensate, as in a stripper column, and a higher fraction of pure condensate exits the column. Thus, keep in mind that the ICT inlet concentration of methanol is reduced from 300 mg/L to a concentration ranging between 35-80 mg/L, clearly indicating that the function of ICT is fulfilled. Consequently, the methanol from the

ICT inlet is instead found in the "foul" side condensate, reducing the purity of the B-condensate. The used settings will therefore need to be selected by weighting the pros and cons of less pure A- and B-condensate, but higher amount of A-condensate or purer condensates but a smaller quantity of A-condensate. The recommended ICT setting for receiving a higher amount of A-condensate while maximising the purity of said condensate is that of case ICT 1, as shown in table 5.3. This is due to optimum combination of vapour flow, methanol content in flows and stripping efficiency of each effect. The concentration of methanol in the ICT inlet is the same for both effects thus the difference lies primarily in the content of the inlet vapour.

As mentioned above the ICT in EF7 was also tested. The settings of the ICT flow were tested either on or off. As the foul side did not have a sampling point, only the concentration of exiting clean side condensate from EF7 was sampled. The foul side condensate is of C-quality, and the clean side is of B-quality. The methanol concentrations measured on the clean side are shown in table 5.4.

Table 5.4: The concentration of methanol(mg/L) measured on the clean side condensate leaving EF7. Samples were taken 2 times, hence referred to as sampling 1 and 2.

Name	Effect 7			Total B-cond. ⁺ (kg/h)
	ICT inlet* (kg/h)	7b Sampling 1 (mg/L)	7b Sampling 2 (mg/L)	
ICT on	234	300	340	107
ICT off	0	220	200	150

* These methanol flows was estimated by Valmet's model and is also used in the project model. The concentration of the inlet ICT flow was measured to be 550 mg/L (see table G.1).

+ Total amount of methanol in B-condensate from EF7 and in ICT inlet. The average concentration from sampling was multiplied with the corresponding flow.

From table 5.4 the concentration of the B-condensate leaving the effect increases as the ICT is turned on and reduces as it is turned off. This is a response of the extra inlet flow. The inlet $234 m^3/h$ of intermediate quality condensate is stripped off as the rising vapour captures the contaminants which the ICT flow holds. By comparing the amount of methanol in the ICT flow entering EF7 with the leaving B-condensate from the effect, the total amount of methanol is reduced when the ICT is turned on, as shown in table 5.4. This implies that there is more B-condensate when the ICT is turned on and that the amount of methanol is less. As the B-, similarly as the A-condensate is re-used, it is desired to produce more of this quality.

5.2 The development of the project model

The model development used sample results and process data from the second operational load of 910 t water evaporated/h. Images of the project model can be found in appendix H.

The amount of methanol initially used as input for the modelling was calculated from the results of the sampling (table 5.2) and total A-, B-, C-condensate and ICT flow measurements from SCA Östrand and was determined to be 1106.5 kg methanol/h (901.3 kg/h in condensates, 205.2 kg methanol/h in all ICT flows).

During model optimisation the number of VLE stages on the clean condensation side were determined by comparing computed values with sample results. The final selections of number of stages and efficiencies are presented in table 5.5.

Table 5.5: Results from model optimisation during development of project model

Optimisation measures	EF 3	Flash cond.	EF 4	EF 5	EF 6	EF 7	Surface cond.
No of VLE stages on clean side	3	2	2	2	2	2	1
VLE efficiency on clean side for each stage	1	0.9	1	0.8	0.9	0.8	0.3
VLE efficiency on foul side	1	0.8	0.5	0.6	1	1	0.1

Changing the amount of vapour ventilation in each effect was not used as an optimisation measure since the difference in computed values was almost non-existent (appendix I) making the measure inefficient. The used measures are as shown in table 5.5. Interpreting the final optimisation, it implies that the actual number of VLE stages should be slightly less than the used. This was corrected with the use of stage efficiency, meaning the used VLE ratio in each stage for an effect and side was reduced by a certain efficiency factor.

A low efficiency indicates that fewer VLE stages should be used but the least possible is one stage. However, the low efficiency may also be due to faulty estimation of methanol content in previous calculations of the evaporation train. There is also a possibility of errors in sample results which are used during the optimisation.

It would seem that the used number of VLE stages on the clean side correspond with the methanol content entering the condensation zone in the effect. As the content increases it becomes more difficult to get a clean condensate thus less VLE stages are required in the simulation. The VLE efficiencies are also in line with the assumption with the exception of the foul side in EF4. The exception could be due to incorrect ventilation flow, sample result or an other VLE relationship should be used.

However, it is more probable that both the number of VLE stages on the clean side and the VLE efficiencies are a question of equipment design. The placement

of the vapour inlet affects the vapour and the condensate in counter-flow and the degree of counter-flow. There is also the matter of degree of surface contact, which is dependent on the baffle design in the effects. Less surface contact and counter-flow would decrease the number of VLE stages and the VLE efficiencies. This seems to be confirmed by the surface condenser in table 5.5. The effects are similar in design but the surface condenser is much simpler build since most of the methanol is apparent when the first black liquor vapour is condensed and the cost of the surface condenser may then be reduced by a simpler design [4]. The low VLE efficiencies in the surface condenser (especially the foul side) may be due to incorrect assumption of ventilation flow from surface condenser. When the project model was optimised, meaning the efficiency measures mentioned above were implemented, the results from the project model (seen in table 5.6) were computed.

Table 5.6: The concentrations estimated from the project model in relation to the concentration from sampling at SCA Östrand during model development.

Sample name	Project model (<i>mg/L</i>)	Sampling data (<i>mg/L</i>)	Relative difference (%)
3.a	72	65	11
3.b	2160	2130	1
Flash cond.c1	1252	1355	-8
Flash cond.c2	7773	7195	8
Vent. cond.c	48576	51150	-5
4.a	84	85	-1
4.b	1663	1780	-7
5.b	603	600	0
5.c	5925	6450	-8
6.b	336	340	-1
7.b	300	300	0
Surface cond.b	317	340	-7
Surface cond.c	7150	9060	-21

The relative difference between the modelled data and the actual data in table 5.6 is small except for the surface condenser. There is a general trend of underestimating the methanol content in the condensates compared to the sample results. Theoretically, if the methanol is underestimated in all effects then there should be an overestimation in the surface condenser since it is where the ventilation vapours are condensed. However, that is not what is shown in table 5.6.

There is an underestimation in the surface condenser, which indicate that the surface condenser was difficult to model. A possible explanation of the larger relative difference in the surface condenser is equipment design and/or ventilation estimation.

Another possible reason can be the assumption of a binary system. In appendix F it can be found that compared to the other sample results there is a high amount of sulphuric compounds and nitrogen in the foul condensate from the surface condenser. Hence, a possible amendment would be to assume a multi-component system in the surface condenser. Other compounds may influence and therefore modifying the

VLE relationship.

The developed project model could thus be applied for evaporation plants for which the designs of the effects are similar to that of SCA Östrand. Meaning condensate segregation is done by a internal segregation with counter-flow on the clean fraction side, existing baffles which increase surface contact and resemble stage plates, and co-current flow on the foul fraction side.

If the project model is in to be applied for another plant with similar design of effects there are a number of variables which need to be in accordance with the plant and process operation case in question. The liquor, vapour and condensate pathway need to correspond to the configuration of the effects at current plant. Flows and saturation temperatures need to cohere with process operation.

5.3 Comparison between models

The final project model and Valmet's model varies compared to the laboratory results. In fig. 5.1 the estimated concentration from the project model and from Valmet's model are correlated to the concentration obtained from the sampling. The letter refers to the condensate quality obtained, and the numbers in front of these letters refers to the concerned effect.

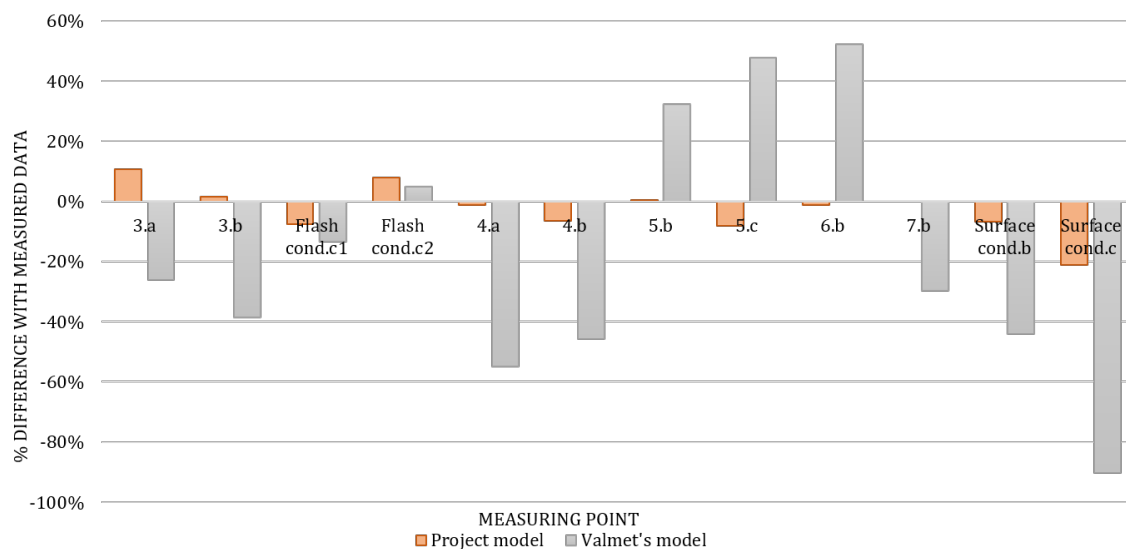

Figure 5.1: Percentile difference of methanol concentration (mg/L) of the condensates estimated by the project and Valmet's model when related to sampling data in the 910 t/h case.

The estimated concentration from Valmet's model differ more than the concentration from the project model. As the concentration alone only tells the amount of methanol in the condensates, the methanol flow from the models can be compared as a complement. However, as the condensate flows from both models are very alike the relative difference is the same as in fig. 5.1, see appendix J.

Both models have a large underestimation in the surface condenser condensates. This confirms the stipulation discussed in section 5.2 that the surface condenser is difficult to model.

5.3.1 Comparison of ICT modelling

For comparing the project model, the laboratory results and Valmet’s model, the concentration of the condensates leaving the effects with implemented ICT are of concern. The results from comparing the ICT in EF3 and 4 will be presented first, followed by EF7. As there are no flowmeters of the condensates leaving the effects, the concentrations from the laboratory are multiplied with the flow from both the project model and Valmet’s model for comparison. The flow from the models are not identical which is why there are two bars in the figures below to compare with the measured concentration.

Five different tests were performed on EF3 and 4 (see table 5.3) and the first test which is shown in fig. 5.2 illustrates a normal case, when the inlet ICT flow into each effect is evenly distributed. The total ICT flow for EF3 and EF4 is continuously $260\text{ m}^3/h$ due to operational load.

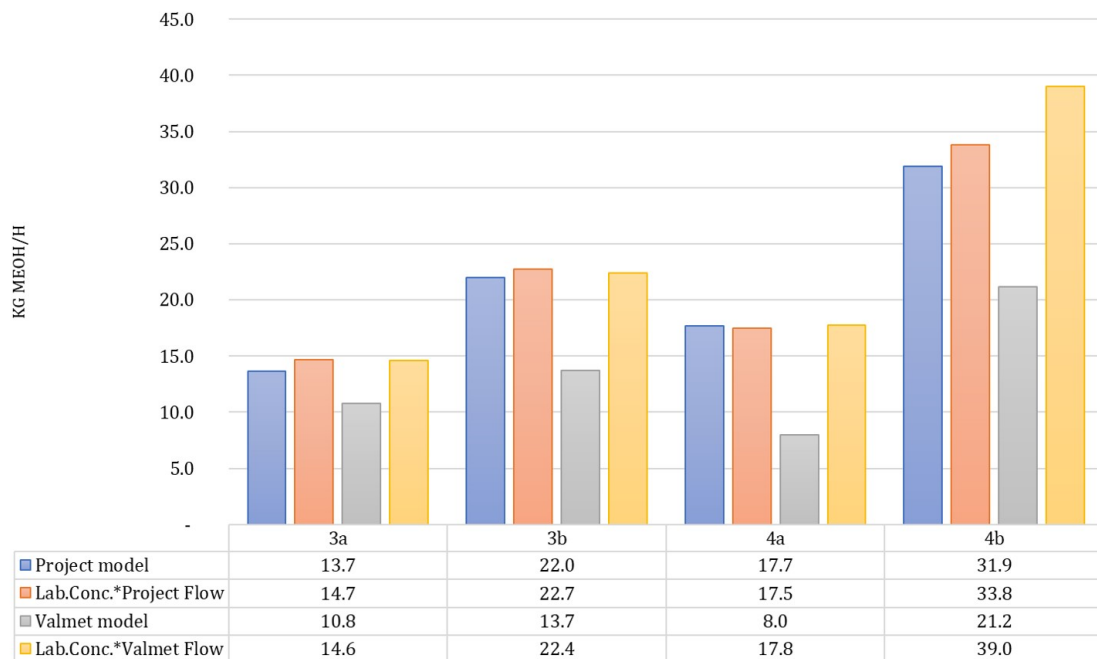

Figure 5.2: Methanol flow (kg MeOH/h) leaving EF3 and 4 under the ICT conditions: 130 t/h entering EF3 and 130 t/h to EF4.

In fig. 5.2 the methanol flows from the laboratory concentrations multiplied with both the project model (orange bar) and Valmet’s model flow (yellow bar), are quite alike. This indicates that the calculated flows are similar, which means the displayed difference between the project model and Valmet’s model is due to the estimated methanol concentration in the two models.

The methanol flow calculated by Valmet’s model is generally lower than the one from the project model. This can be explained by the inlet methanol amount which is approximately 100 mg/L lower in Valmet’s model than in the project model. The reason for this is the loop which is present in the system (mentioned in section 2.2.3). As the loop is not considered in the project model, the inlet concentration of this model is set to be constant at 300 mg/L into EF3 and 4. Valmet takes the loop

in consideration and the inlet concentration is calculated depending on capacity, and since the plant is not operating at maximum load, the concentration is underestimated. Moreover, the inlet ICT flow seem to be constant when observing all sampling data, see appendices F and G, point *ICTin3/4.b*. Except the normal case when the inlet ICT flow is the same into the two effects, four more unusual cases were tested to see if the project model would follow with various inlet flows. Computed values by Valmet's model are present in the figures. They should however to a certain amount be discounted since the amount of input methanol in each effect is incorrect as explained above. In figs. 5.3 to 5.6 the ICT inlet settings are diverse in EF3 and 4.

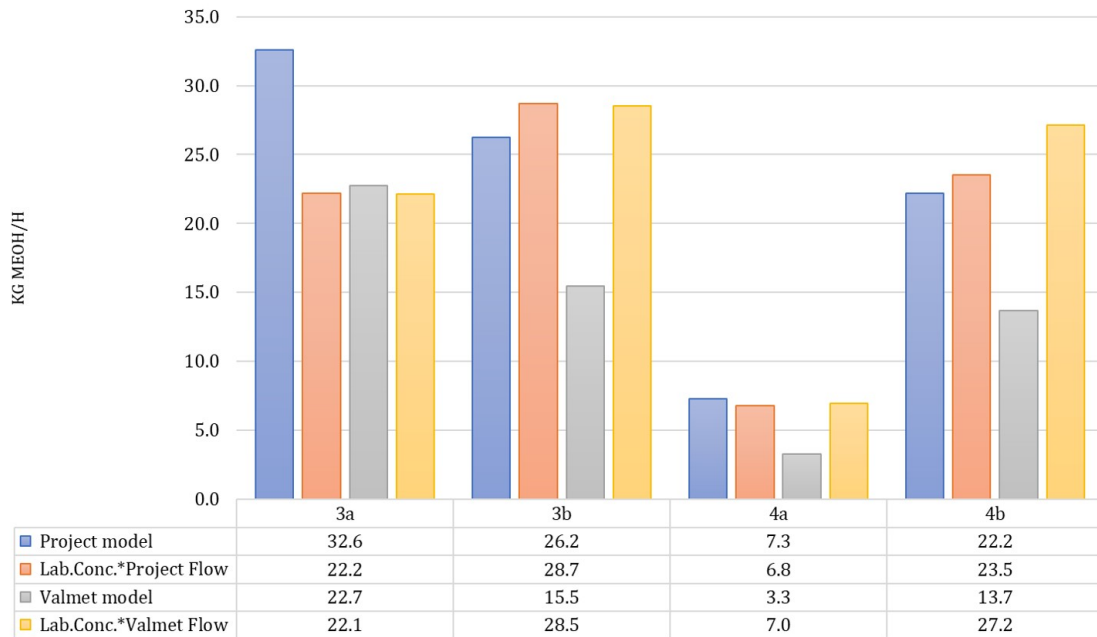

Figure 5.3: Methanol flow (kg MeOH/h) leaving EF3 and 4 under the ICT conditions: 200 t/h entering EF3 and 60 t/h to EF4.

As seen in fig. 5.3 the methanol flow from the clean side in both EF3 and 4 are overestimated by the project model when compared to the orange bar and correspondingly the foul side of the effects are underestimated. However, the summation of each colour bars in each effect should be the same. The summation of the methanol amount of the blue bars (project model) in EF3 is 8 kg methanol/h more than what the laboratory results indicate the amount should be. This implies that either the inlet amount of methanol is overestimated or the ventilation is underestimated for EF3 in the project model. Since the summation of the blue and orange bars in the figure showing the normal ICT case is almost equal, the indication is that the ventilation flow is underestimated. Furthermore, because of the larger difference in total outlet methanol amount the simulation issue may not be "fixed" by changing VLE stages and efficiencies. The same project model issue is not present for the simulation of lower ICT inlet flow in EF4 where the summation of simulated clean and foul side content is almost equal to the sample results.

Observing Valmet's model, the clean side of EF3 is about equivalent to the actual methanol flow, as the foul side condensate content is highly underestimated (com-

parison with yellow bar). The simulation results inconclusive due to the reason explained above.

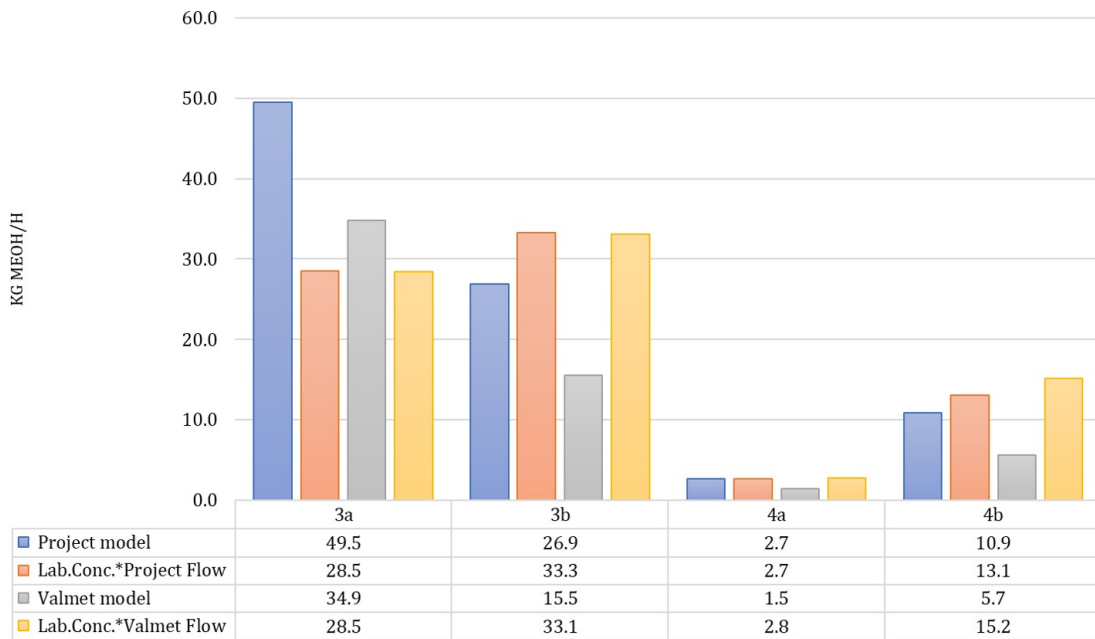

Figure 5.4: Methanol flow (kg MeOH/h) leaving EF3 and 4 under the ICT conditions: 260 t/h entering EF3 and 0 t/h to EF4.

As seen in fig. 5.4 the ICT inlet to EF4 is zero as all ICT flow enters EF3. Again, the results are similar as when 200 t/h was entering EF3 and 60 t/h to EF4. The project model overestimates the methanol outlet flow from EF3 whereas the simulation for EF4 is more consistent with laboratory results. Since there is no ICT inlet to EF4, the slight underestimation of foul side methanol in EF4 indicates that the ventilation is overestimated or there should be more methanol in the inlet vapour together with a smaller change in the VLE efficiencies.

Increasing the ICT inlet further is the cause of the overestimation of the clean side methanol flow from EF3 in Valmet's model. But as shown, the increase of inlet methanol is not enough to cause the total methanol outlet to correspond with the sample results.

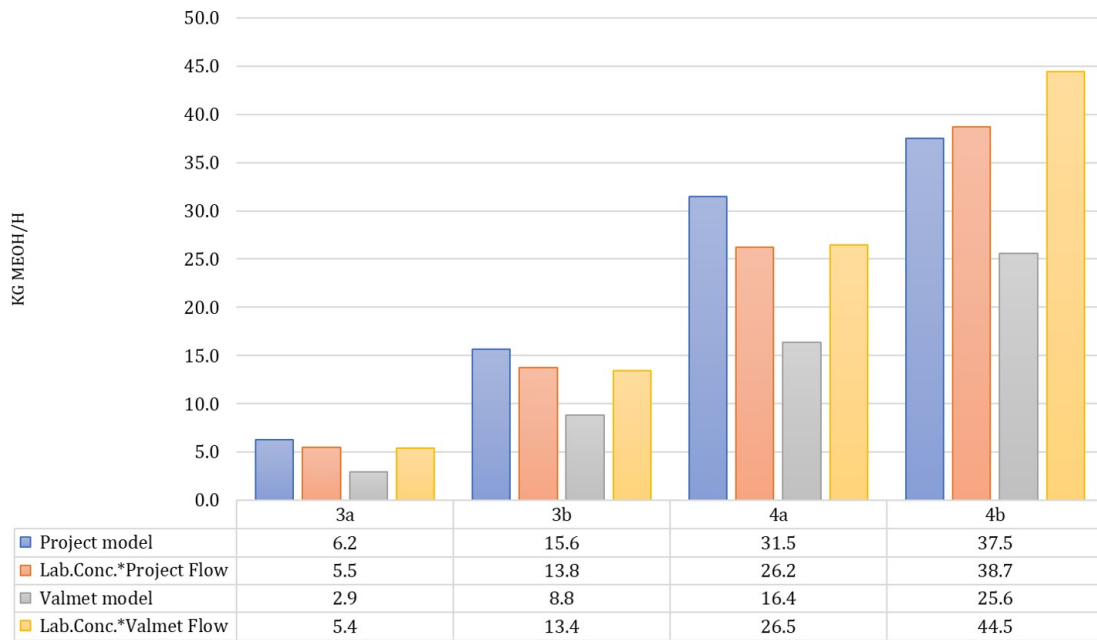

Figure 5.5: Methanol flow (kg MeOH/h) leaving EF3 and 4 under the ICT conditions: 60 t/h entering EF3 and 200 t/h to EF4.

As the flow into EF3 is decreased to 60 t/h as seen in fig. 5.5 a similar result as when the flow into EF4 was 60 t/h, see fig. 5.3, was obtained. The clean side condensate from EF4 is overestimated in the project model and the methanol flow is underestimated by Valmet's model. However, the total methanol outlet in EF4 is not as overestimated as when simulating the same increase of ICT inlet in EF3 in the project model.

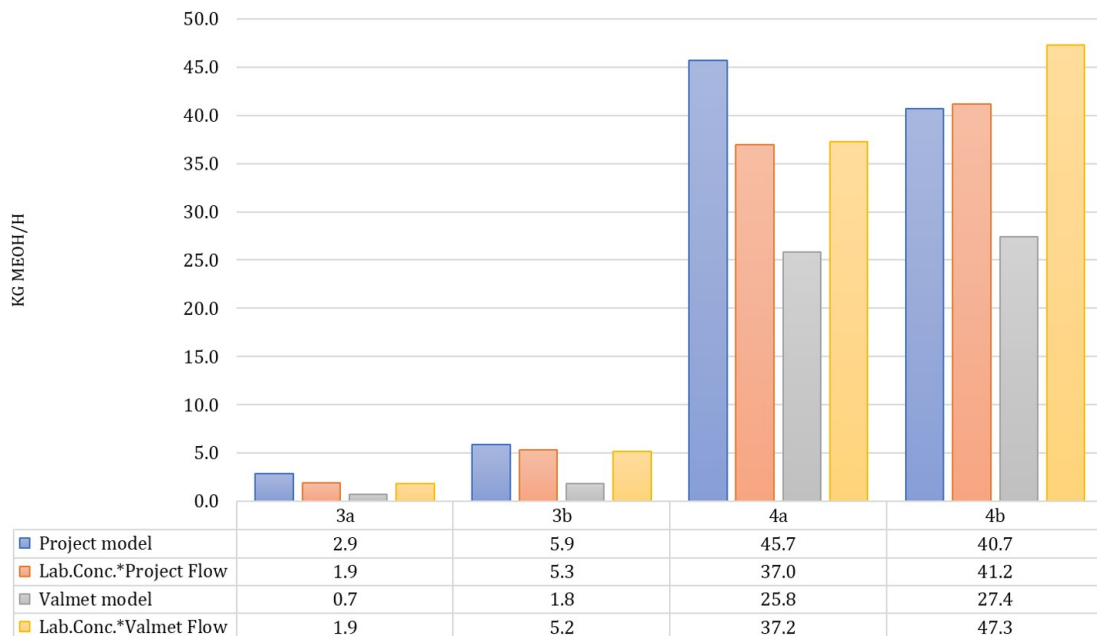

Figure 5.6: Methanol flow (kg MeOH/h) leaving EF3 and 4 under the ICT conditions: 0 t/h entering EF3 and 260 t/h to EF4.

Directing all ICT flow into EF4 further increased the project model's overestimation of total outlet methanol content in EF4. Furthermore, the total methanol from EF3 was slightly overestimated. Since there is no ICT flow to EF3 it means that the ventilation should be higher or the inlet should be lower. A lower inlet of methanol could be achieved by decreasing the VLE efficiency during evaporation of the liquor in EF2. It is also possible that the vapour amount should be less. The amount of evaporated vapour in each effect is not measured, thus the estimation of it could be wrong.

A general trend can be noticed. When the ICT flow into EF3 and 4 increases (compared to the normal setting), the project model tends to underestimate the efficiency of the internal condensate treatment. This is noticed when the blue bar is higher than the orange one. The modelled amount of methanol in the clean side condensate is higher than the one estimated from the samples. If the quantity of methanol is overestimated on the clean side but underestimated on the foul side, it implies that another VLE stage on the clean side could be added or a higher VLE efficiency could be used to "drive" the methanol to the other side. The opposite is also possible. However, since the total outlet methanol is higher than that estimated with sample results, such a measure would be inefficient. Hence, the overestimated content would be moved from one side to the other.

The comparison of project model simulation during no ICT inlet and sample results indicate that there should be slightly more inlet methanol or less ventilation in EF4 and the opposite is true for EF3. It is likely that the assumption of no evaporation of the ICT condensate is incorrect and the ventilation flow is related to the evaporation of the ICT condensate.

Simultaneously, Valmet's design model seems inclined to continuously overestimate the internal condensate treatment efficiency regardless of ICT inlet. The methanol amount in both clean and foul side condensate is less than the projected amount from the sample test because of the question of input. If the inlet quantity of methanol is smaller than the actual one, then the results will be misleading. There will simply not be enough methanol to direct to either side thus explaining the underestimation on both clean and foul side.

When testing the ICT in EF7, the ICT flow was turned either on or off, see fig. 5.7.

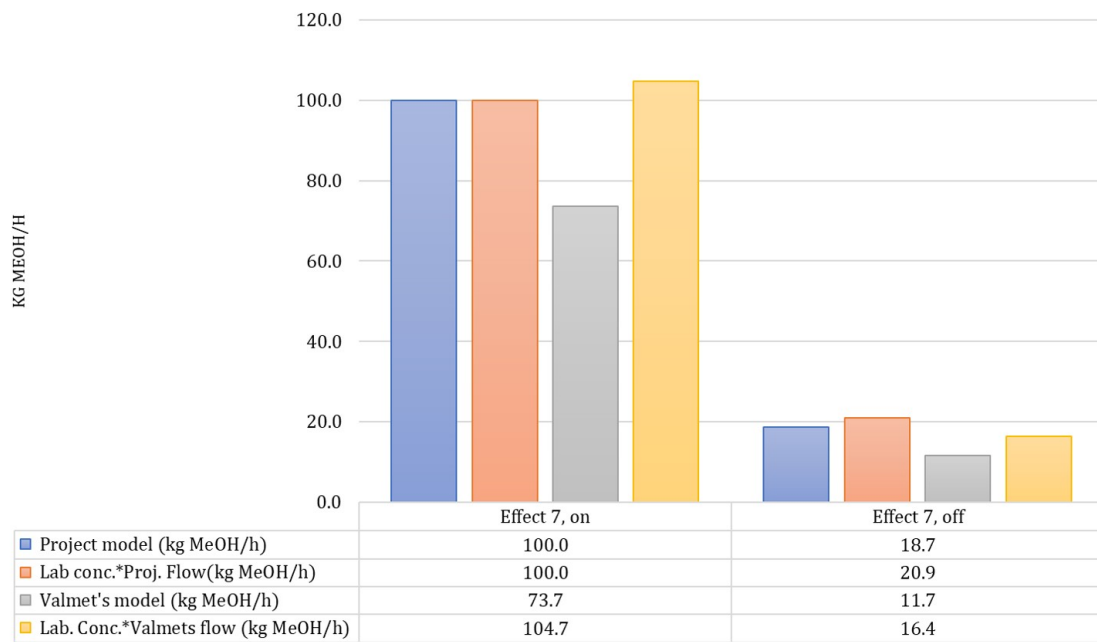

Figure 5.7: Methanol flow (kg MeOH/h) leaving EF7 on the clean side when the ICT inlet was set either on/off.

As seen in fig. 5.7 the project model values are close to the laboratory results, both when the measured concentration is combined with the flow estimated from the project model and Valmet's model. The same discussion of total outlet methanol amount is obviously not possible due the missing sampling spot.

As during previous simulation of ICT settings, Valmet were consistent with an underestimation in EF7 as well. When comparing the modelling of ICT in EF3 and 4, the project model is closer to the measured data, as Valmet's model almost always underestimates the leaving methanol flow. This may be due to faulty input of methanol, or the requirement placed on Valmet to meet their methanol content guarantees. It is then better to underestimate the amount of methanol instead of overestimate it. Looking at methanol as a product, it is better to underestimate the amount that can be extracted, instead of promising an uncertain outlet. Moreover, Valmet's model is constructed to primarily correspond to the design capacity which is 1150 t/h and not the 79% of the maximum plant capacity.

5.4 Verification of the project model

In this section the first sampling which was extracted at 610t/h was modelled in the project model with the optimisation measurements performed for the 910t/h case. Moreover, this setting was compared with Valmet's model to see if the same deviations occurred when the evaporation rate was decreased.

Table 5.7: The concentration estimated from the project model in the 610t/h case in relation to the concentration from the sampling at SCA Östrand.

Sample name	Project model (mg/L)	Sampling data (mg/L)	Relative difference (%)
3.a	59	65	-9
3.b	1655	1510	10
Flash cond.c	1316	1300	1
4.a	75	75	0
4.b	1424	1140	25
5.b	581	540	8
5.c	5328	5610	-5
6.b	316	360	-12
7.b	275	280	-2
Surface cond.b	264	270	-2
Surface cond.c	6748	8340	-19

As shown in table 5.7 there are fluctuations when comparing the project model with the measured concentrations. The fluctuations are bigger than the ones for the 910t/h case (see table 5.6). However, as the project model was optimised for the large evaporation rate, the result was expected to vary more for the lower rate. Also, most values differ up to 15 % from the measured data, which is promising for the project model optimisation measures meaning that the estimated VLE relations correspond with reality. The overestimation of methanol content *3.b* and *4.b* may be due to faulty estimation of ventilation flow. The results imply that the ventilation flow should be estimated even higher when the load of the evaporation plant is lower at 610t/h and that the current weighting of the ventilation flow. The same may be applied to *5.c* and *Surface cond.c* where the ventilation flow should be estimated to be less instead. A lower ventilation flow in EF6 and the surface condenser would also be preferable when looking at the results from the model optimisation (table 5.6). However, the same can not be said for *3.b* and *4.b*. Thus the ventilation flow estimations are still inconclusive.

The project model was also compared with Valmet's model with the same settings, see fig. 5.8.

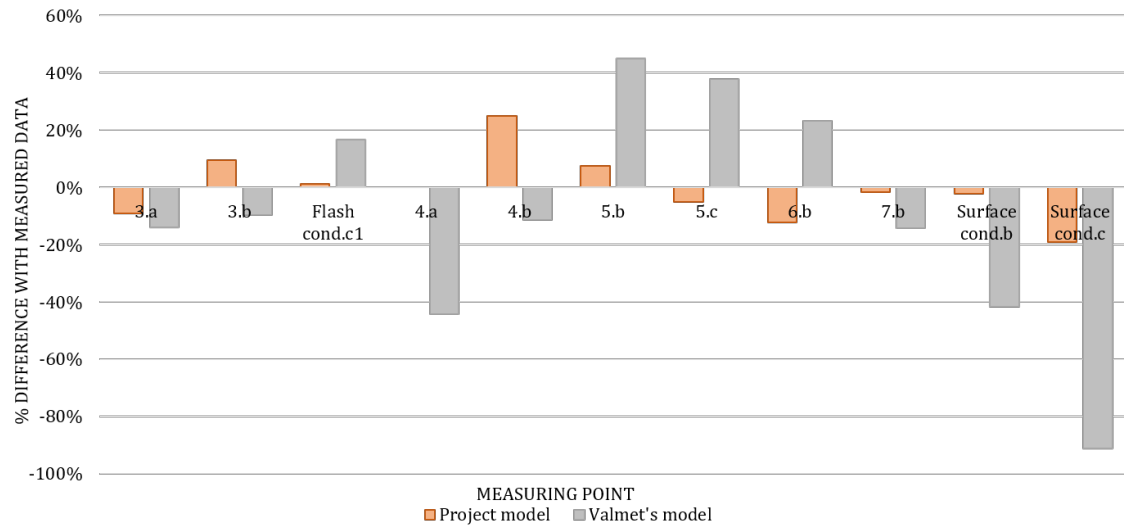

Figure 5.8: Percentile difference of methanol concentration (mg/L) of the condensates estimated by the project and Valmet’s model when related to sampling data in the 610 t/h case.

When comparing the percentile differences of the models and the measured data from the 610 t/h case, the project model is shown to be more in line with the measured concentration. Similar to fig. 5.1, comparing the concentration is similar to when comparing the methanol flow out from each effect (see also appendix J).

Comparing figs. 5.1 and 5.8 there is no definite theme of the project model as it is for Valmet’s model. Valmet’s model tends to overestimate the methanol from EF5 and EF6 and underestimate the concentration from EF3, 4 and 7. Both models also have difficulties with modelling the surface condenser, which can be examined in future studies.

6 Future work

Further work on this thesis would be to perform a second sampling, preferable at the plants maximum capacity at 1150 tonne water evaporated/h. The second sampling can be used to verify the project model further, and the optimisation measures can be examined further. Moreover, it would be interesting to investigate how much electrolytes there are in the liquor and the real effect on VLE.

Improvements can also be done by extending the model. This extension can include removing the limitations of this thesis and account for the loop formed between EF3, 4 and 7. Moreover, include S1AB and EF1 and model the surface condenser with a different approach. Possibly a multi-component system can be assumed in the surface condenser due to the high amount of other substances which was shown from the laboratory results.

7 Conclusion

At SCA Östrand, the sampling took place under two different settings of the evaporation plant, 610 t/h and 910 t/h. At the sampling at 610 t/h more medium strong liquor was inserted than in normal cases. Hence, the model was designed to match primarily the higher capacity.

Initially the project model used data from the 910 t/h case. The liquor flow was modelled from inlet to the evaporation plant (into tube flash) and until EF2 (see fig. 2.7) The condensate segregation was modelled for the effects; 3, flash condenser, 4, 5, 6, 7 and the surface condenser (see fig. 2.8). The number of VLE stages and stage efficiency are presented in table 5.6. The effect which required three VLE stages on the clean side of the condensate segregation was EF3, the rest of the effects only required one or two VLE stages.

The relative difference between computed values and sample results were not larger than 15 %, in both the 610 t/h and 910 t/h case. However, there is a general underestimation of methanol in the condensates compared to sample results. The methanol which is not apparent in the effects should be visible in the surface condenser condensates. However, it is not. The main difficulty for the project model was consequently to design the surface condenser.

By modelling the ICT in EF3, 4 and 7 the project model was more in line with the results from laboratory tests than Valmet's model. Generally, Valmet's model underestimated the inlet methanol flow which can be explained by the model being constructed to provide results of the design capacity, and not at an operational load of 79 % of the maximum plant capacity.

The project model was verified with the 610 t/h case, and the results showed a promising percentile difference. Future work would include additional sampling and extension of project model, a sampling of the maximum capacity would be preferable. The project model can be used for other evaporation plants for which the designs of the effects are similar to that of SCA Östrand.

By modelling the evaporation plant at SCA Östrand as a vapour-liquid equilibrium system the methanol flow was estimated within a 15 % range from the measured concentration. Even when the amount of evaporated differed from the maximum capacity. Hence, the project model utilising VLE and steady state relations were a good tool to simulate the methanol in the condensates.

Bibliography

- [1] C. J. Biermann, “Handbook of pulping and papermaking (2nd edition)”, in. Elsevier, 1996, ch. 3. Pulping Fundamentals, ISBN: 978-0-12-097362-0.
- [2] M. Kassberg and O. F. Borg, *Lutindunstning och biprodukter*, [4]. Markaryd: Skogsindustrins utbildning i Markaryd, 1994, ch. 13. Biprodukter, ISBN: 91-7322-176-7 (spirallh.)
- [3] C. J. Biermann, “Handbook of pulping and papermaking (2nd edition)”, in. Elsevier, 1996, ch. 4. Kraft spent liquor recovery, ISBN: 978-0-12-097362-0.
- [4] Valmet, Personal communication, 2019.
- [5] Z. Amjad and K. D. Demadis, *Mineral scales and deposits - scientific and technological approaches*. Elsevier, 2015, ch. 21.1 The Kraft Chemical Recovery Process, pp. 557–558, ISBN: 978-0-444-63228-9.
- [6] T. Särkkä, M. Gutiérrez-Poch, and M. Kuhlberg, “Technological transformation in the global pulp and paper industry 1800-2018: Comparative perspectives”, in. Cham: Springer International Publishing, 2018, ch. Introduction, pp. 1–10, ISBN: 978-3-319-94962-8.
- [7] E. J. Henley and D. K. Seader J.D. and Roper, *Separation process principles*, 3rd ed. John Wiley & Sons, Inc., 2011.
- [8] M. Ek, G. Gellerstedt, and G. Henriksson, “Pulp and paper chemistry and technology - pulping chemistry and technology, volume 2”, in. Berlin, Boston: De Gruyter, 2009, ch. 12. Recovery of Cooking Chemicals: the Treatment and Burning of Black Liquor. [Online; accessed January 31, 2019], ISBN: 978-3-11-021341-6.
- [9] *Pubchem [electronic resource]*, [Online; accessed February 1, 2019], 2004.
- [10] M. Redeborn, A. Wernqvist, and K. Ström, “Adaptable calculation method for segregation of contaminants in vapours formed from black liquor”, *Nordic Pulp & Paper Research Journal*, vol. 13, no. 3, pp. 172–179, 1998.
- [11] SCA, *Our history*, <https://www.sca.com/en/about-us/This-is-sca/Our-history/>, [Online; accessed April 10, 2019].
- [12] —, *A world leading pulp producer*, <https://www.sca.com/en/about-us/This-is-sca/Our-businesses/ostrand-pulp-mill/>, [Online; accessed April 10, 2019].
- [13] A. Norin, *Utvärdering av kondensatbehandling i industrianläggningar = evaluation of condensate treatment in black liquor evaporation plants*. Chalmers tekniska högsk., 2004. [Online]. Available: <http://proxy.lib.chalmers.se/login?url=http://search.ebscohost.com.proxy.lib.chalmers.se/login.aspx?direct=true&db=cab06296a&AN=clc.b1307992&site=eds-live&scope=site>.
- [14] J. R. Elliott and C. T. Lira, *Introductory chemical engineering thermodynamics*. Ser. Prentice-Hall international series in the physical and chemical engineering sciences. Upper Saddle River, NJ : Prentice Hall, 2012., 2012, ISBN: 978-0-13-606854-9.

A Schematic overview of plant

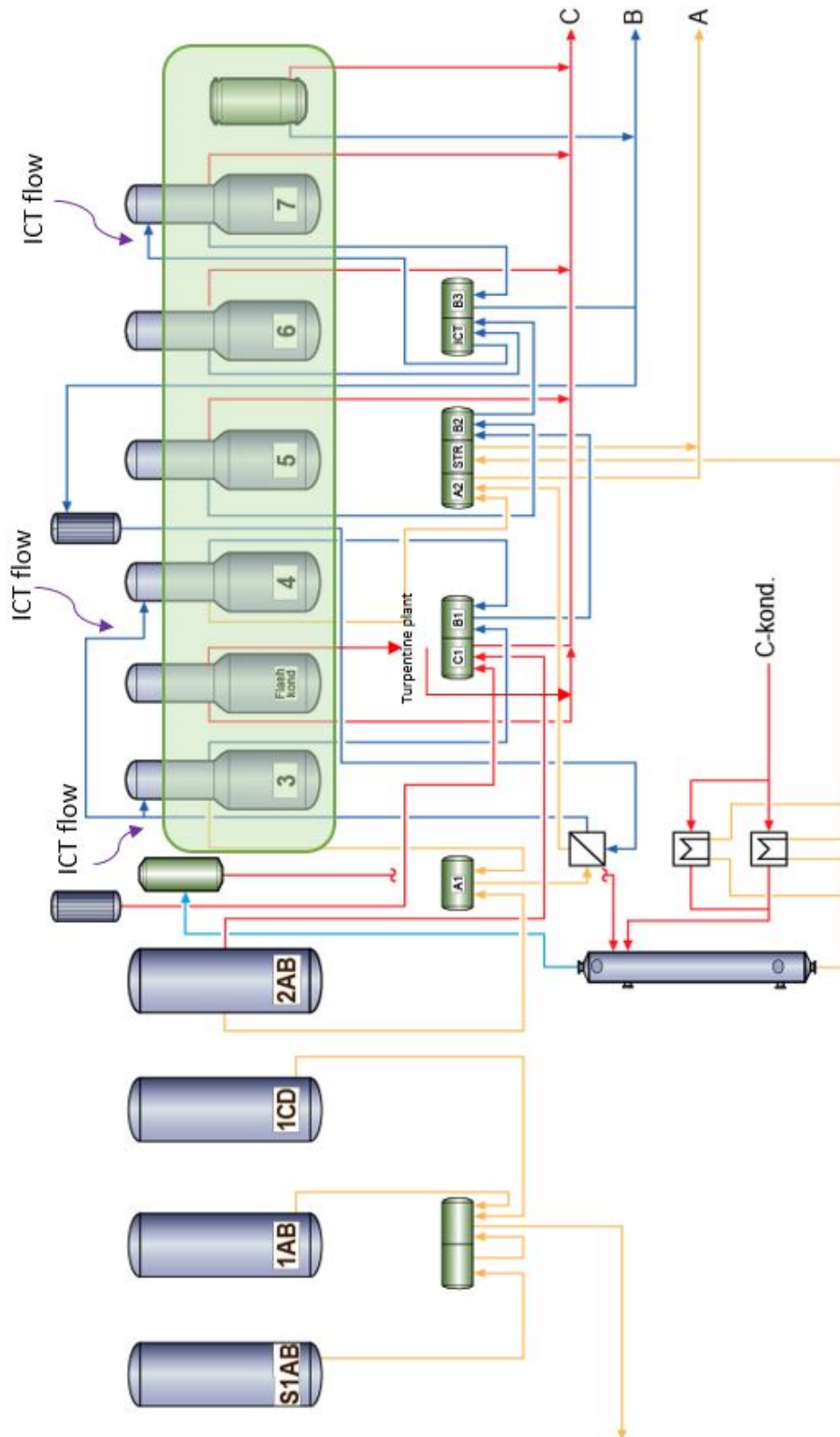

Figure A.1: Schematics of the entire evaporation plant (condensate flow). The green shape represents the system boundary of the condensates in the project model. As shown the condensate flash tanks and B-condensate loop are not accounted for in the model.

B Vapour-liquid equilibrium

Vapour-liquid equilibrium (VLE) conditions will determine how much of the methanol and other volatile compounds will end up in each condensate. The phenomenon can be described by a successive condensation model or a model with several equilibrium stages. The successive condensation model assumes that the vapour is condensed successively with no contact to the down-flowing condensate [10].

Vapour-Liquid Equilibrium

This section is dedicated to describe the vapour-liquid equilibrium (VLE) equations which are of usage when describing the conditions for vapour-liquid mixtures at equilibrium. Also, a description of how the VLE equations can be used to predict the condensate composition will be presented.

The conditions for a vapour-liquid mixture at equilibrium are given by eqs. (B.1) to (B.3) below.

$$P_V = P_L = P \quad (\text{B.1})$$

$$T_V = T_L = T \quad (\text{B.2})$$

$$f_{i,V} = f_{i,L} \quad (\text{B.3})$$

The conditions for equilibrium is that there has to be an equality of pressure and temperature. Where V denotes vapour and L for liquid. Each species, i must also have the same fugacity, f in both phases.

The partial fugacity coefficients for a species in a vapour-liquid mixture are defined as eqs. (B.4) and (B.5) below.

$$\bar{\phi}_{i,V} \equiv \frac{\bar{f}_{i,V}}{y_i P} \quad (\text{B.4})$$

$$\bar{\phi}_{i,L} \equiv \frac{\bar{f}_{i,L}}{x_i P} \quad (\text{B.5})$$

Where y_i is the molar fraction of the given species in vapour phase, and x_i is the molar fraction of the species in liquid phase. The physical significance of the partial fugacity coefficients is that these denote the deviations to fugacity due to non-ideal behaviour.

The eqs. (B.4) and (B.5) can be rewritten to eqs. (B.6) and (B.7), where the liquid fugacity can be expressed in two different ways. Either as a function of the fugacity coefficients (f_i) or as an function of the activity factor, γ_i .

$$\bar{f}_{i,V} = \bar{\phi}_{i,V} y_i P \quad (\text{B.6})$$

$$\bar{f}_{i,L} = \bar{\phi}_{i,V} x_i P = \gamma_i x_i f_i^\circ, \quad (\text{B.7})$$

where $\phi_{i,V} = 1.0$ if the vapour behaves as an ideal gas and the activity coefficient, $\gamma_i = 1.0$ if the liquid behaves as an ideal solution. f_i° is the fugacity at standard state, meaning the pure component fugacity at the same temperature and pressure.

The activity coefficient, γ_i is related the Gibbs excess energy function, g^E and can be derived from eq. (B.8) [14].

$$RT \ln \gamma_i = \left[\frac{\partial(n_{tot} g^E)}{\partial n_i} \right]_{P,T,n_{j \neq i}} \quad (\text{B.8})$$

n_{tot} refers to total amount of moles and R is the Boltzmann constant, γ can be derived from any expression of $g^E(T, P, x)$. [7], [10], [14]

Combining eqs. (B.6) to (B.8) makes it possible to determine y_i and x_i if the vapour fugacity, the liquid standard fugacity and pressure are previously specified.

C NRTL

NRTL model expressions of g^E , Gibbs excess energy function (eq. (C.1)) and γ , the activity coefficient (eq. (C.2)).

$$\frac{g^E}{RT} = \sum_{i=1}^n x_i \frac{\sum_{j=1}^n \tau_{ji} \Lambda_{ji} x_j}{\sum_{k=1}^n \Lambda_{ji} x_k} \quad (\text{C.1})$$

$$\ln \gamma_i = \frac{\sum_{j=1}^n \tau_{ji} \Lambda_{ji} x_j}{\sum_{k=1}^n \Lambda_{ji} x_k} + \sum_{j=1}^n \frac{x_j \Lambda_{ij}}{\sum_{k=1}^n \Lambda_{kj} x_k} \left(\tau_{ij} - \frac{\sum_{i=1}^n x_i \tau_{ij} \Lambda_{ij}}{\sum_{k=1}^n \Lambda_{kj} x_k} \right) \quad (\text{C.2})$$

Both τ and Λ are NRTL-parameters which can be found in literature for the binary vapour-liquid mixture of methanol and water[13].

D Sampling points

Table D.1 provide the names of the samples, what was analysed in each sample and what each sample tells us, for instance which type of condensate.

Table D.1: Name of the samples, what was analysed on each sample and what the samples correspond.

Sample name	Analysed compounds	Comment
1E.c	MeOH, S	C-condensate from section "E" in EF1CD
2A.a	MeOH	A-condensate from section "A" in EF2AB
2A.c	MeOH	C-condensate from section "A" in EF2AB
2B.a	MeOH	A-condensate from section "B" in EF2AB
2B.c	MeOH	C-condensate from section "B" in EF2AB
2E.c	MeOH	C-condensate from section "E" in EF2AB
2ABcond.c	MeOH, S	C-condensate from condenser after EF2AB
3.a *	MeOH	A-condensate from EF3
3.b *	MeOH	B-condensate from EF3
ICTin3/4.b *	MeOH	Inlet B-condensate to ICT in EF3 & EF4
Flash cond.c1	MeOH, S & N	Condensate from flash condenser
Flash cond.c2	MeOH, S & N	Condensate from flash condenser
Vent.cond.c	MeOH, S & N	Condensate from flash ventilation
4.a *	MeOH	A-condensate from EF4
4.b *	MeOH	B-condensate from EF5
5.b	MeOH	B-condensate from EF5
5.c	MeOH	C-condensate from EF5
6.b	MeOH	B-condensate from EF6
7.b *	MeOH	B-condensate from EF7
ICTin7	MeOH	B-condensate inlet to ICT in EF7
Surface cond.b	MeOH, S & N	B-condensate from surface condenser
Surface cond.c	MeOH, S & N	C-condensate from surface condenser
Sep. tank.c	MeOH, S & N	C-condensate from surface condenser
K4	MeOH, S & N	Part of C-condensate from EF7
Tot A	MeOH, S & N	Leaving A-condensate from plant
Stripper cond.	MeOH & S	Treated condensate from stripper
Tot B	MeOH, S & N	Leaving B-condensate from plant
Tot C	MeOH, S & N	Leaving C-condensate from plant

The sample names marked with * was also collected when testing internal condensate treatment (ICT).

In fig. D.1 the sample points mentioned in table D.1 are marked with a yellow dot.

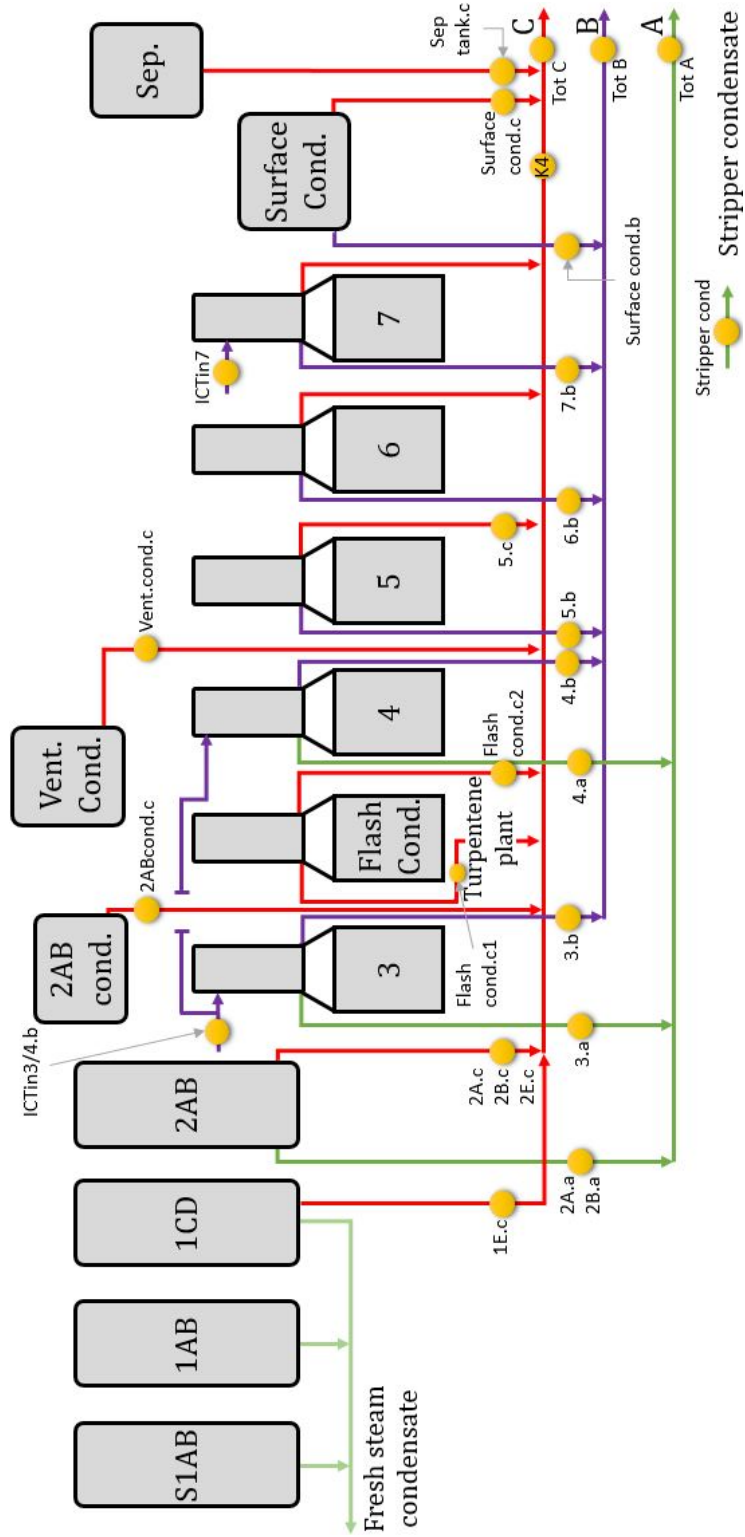

Figure D.1: The sampling points at the evaporation plant at SCA Östrand.

E Model development procedure

The procedure to construct the model is listed as follows.

1. Collect feed liquor flow and its dry solids content which is provided from the pulp mill.
2. Calculate the outlet liquor flow from each effect from the obtained dry solids content. Also, determine the outlet dry solids content for all effects.
3. From the calculated data in previous step, the water which evaporates in each effect can be calculated.
4. Calculate ventilation flow in all effects, the fraction of ventilation is given by Valmet's design data [4].
5. The ventilation flow enables to calculate outlet flow of condensate in each effect, on the clean and foul side.
6. Calculate the vapour and its composition from EF4 by combining eqs. (3.4) and (3.14) to eq. (E.1).

$$y_{i,4} = \frac{F \cdot z_{i,F} + V_{flash} \cdot y_{i,flash}}{V_4 + \frac{L_4}{K_4}} \quad (\text{E.1})$$

7. Set up balances for the effect which the vapour enters, EF5, eqs. (3.20) to (3.24), (3.30) and (3.31) and calculate the variables by iteration
8. Calculate the vapour from EF5 and its composition by combining the eqs. (3.4) and (3.7) which results in eq. (E.2)

$$y_{i,q} = \frac{L_{q-1} \cdot x_{i,q-1}}{V_q + \frac{L_q}{K_q}} \quad (\text{E.2})$$

9. For EF6, do the same procedure as mentioned point 7
10. Calculate the vapour outlet and its composition from EF6 in the same way as point 8
11. Condensation in EF7, same procedure as mentioned in point 7. However, because effect 7 has ICT, the eqs. (3.26) to (3.29) are used to project the extra inlet flow as illustrated in fig. 3.3.
12. Design the bottom of EF7 and from mass- and component balance the vapour leaving EF7 can be determined. The amount of methanol is calculated by the relation described in item 8.
13. Design the bottom of the flash condenser, inlet liquor comes from EF7, Intermediate storage between EF7 and flash condenser is disregarded.
14. Determine the methanol content in the vapour outlet from EF3 as in item 8
15. Model the condensation in EF4, same procedure as item 11

16. The methanol content to the tube flash is determined backwards from experimental data. The tube flash is a single flash stage, thus eq. (E.2) can be applied. The methanol content in the liquor from the tube flash is the same for the feed liquor.
17. The condensation in flash condenser is modelled as in item 7.
18. When all effects are modelled, optimise model by changing number of steps on clean side, adding VLE stage efficiency and interplay with vapour ventilation flow.

F Sample results

Table F.1: Sampling results, the amount of compounds in the condensates from the sampling 26th of February 2019.

Name	Nitrogen (mg/L)	Sulphur (mgS/L)	Methanol (mg/L)
1E.c		34	210
2A.a			25
2A.c			140
2B.a			25
2B.c			85
2E.c			170
2ABcond.c		48	390
3.a			65
3.b			1510
ICTin3/4.b			270
Flash cond.c1	27	11	1300
4.a			75
4.b			1140
5.b			540
5.c			5610
6.b			360
7.b			280
ICTin7.			550
Surface cond.b	5	12	270
Surface cond.c	366	490	8340
Sep. tank.c	109	1700	2880
Tot A	13	8.7	240
Stripper cond.		56	4790
Tot B	5	7.96	260
K4	104	200	3380
Tot C	137	140	4730

Table F.2: Sampling results, the amount of compounds in the condensates from the sampling 27th of February 2019.

Name	Nitrogen (mg/L)	Sulphur (mgS/L)	Methanol (mg/L)
1E.c		26	210
2A.a			25
2A.c			120
2B.a			20
2B.c			80
2E.c			180
2ABcond.c		28	410
3.a			65
3.b			2130
ICTin3/4.b			300
Flash cond.c1(a)*	23	10	1330
Flash cond.c1(b)*	24	0.8	1380
Flash cond.c2(a)*	136	54	6650
Flash cond.c2(b)*	155	90	7740
Vent. cond.c(a)*	1660	7300	51000
Vent. cond.c(b)*	1670	7400	51300
4.a			85
4.b			1780
5.b			600
5.c			6450
6.b			340
7.b			300
ICTin7.			550
Surface cond.b	<5.0	1.2	340
Surface cond.c	238	250	9060
Sep. tank.c	65	1800	3410
Tot A	5	2.73	60
Stripper cond.		4.2	5
Tot B	5	2.05	350
K4	90	80	3900
Tot C	130	200	4250

The sample names marked with * are doublets, samples which was extracted two times because lack of data from the first sampling.

G ICT sample results

Table G.1: Results from sampling when testing the ICT at the plant.

Name	Date	Methanol (mg/L)
3a.ICT1	2019-02-27	75
3b.ICT1	2019-02-27	2690
ICTin3/4. ICT1	2019-02-27	300
4a.ICT1	2019-02-27	50
4b.ICT1	2019-02-27	1240
3a.ICT2	2019-02-27	80
3b.ICT2	2019-02-27	3120
ICTin3/4. ICT2	2019-02-27	290
4a.ICT2	2019-02-27	35
4b.ICT2	2019-02-27	690
3a.ICT3	2019-02-27	35
3b.ICT3	2019-02-27	1290
ICTin3/4. ICT3	2019-02-27	290
4a.ICT3	2019-02-27	95
4b.ICT3	2019-02-27	2040
3a.ICT4	2019-02-27	20
3b.ICT4	2019-02-27	500
ICTin3/4. ICT4	2019-02-27	280
4a.ICT4	2019-02-27	110
4b.ICT4	2019-02-27	2170
ICTin7 on(a)	2019-02-26	550
ICTin7 on(b)	2019-02-28	550
7b.ICT on(a)	2019-02-28	300
7b.ICT on(b)	2019-02-28	340
7b.ICT off(a)	2019-02-28	220
7b.ICT off(b)	2019-02-28	200

H Images of project model

	A	B	C	D	E	F	G	H	I
			Vapour clean side	Effect 3	Flash cond.	Effect 4	Effect 5	Effect 6	Effect 7
1			n:	2	1	1	1	1	1
2			Steg n+1						
3			Vn+1, Vapour to foul side(t/h)	11,350	8,921	19,835	43,513	28,907	34,563
4			Yn+1, MeOH content in vapour to foul side	0,003	0,016	0,002	0,007	0,006	0,004
5			Ln+1, Condensate to step n (t/h)	162,015	10,538	167,975	48,286	53,682	283,465
6			Xn+1, MeOH in condensate to step n	0,000	0,002	0,000	0,001	0,001	0,001
7			Striflow On=1, Off=0	1,000		1,000			1,000
8			Lstrifl, inlet strifkondensate (t/h)	130		130			233,595
9			Xstrifl, MeOH content in strifkondensate	0,000		0,000			0,001
10			Concentration MeOH in strifkondensate (mg/l)	300		300			550
11			Steg n						
12			Ln, Clean condensate (t/h)	226,045	21,076	205,950	96,573	107,363	333,335
13			Xn, MeOH content in clean condensate	0,000	0,001	0,000	0,001	0,000	0,00030
14			MeOH flow clean condensate (t/h)	0,014	0,026	0,018	0,057	0,035	0,098
15			Concentration MeOH in clean condensate (mg/l)	61,046	1221,215	86,315	588,173	327,994	295,418
16			K' on vapour clean side	7,700	7,030	7,85	6,396	7,376	6,729
17			Vn, Vapour flow to step n+1 (t/h)	43,365	19,459	57,810	91,799	82,589	84,433
18			Yn, MeOH content in vapour to step n+1	0,001	0,009	0,001	0,006	0,002	0,002
19			Vapour foul side						
20			Ln+2, Foul condensate(t/h)	10,672	7,025	18,988	41,388	26,841	32,017
21			Xn+2, MeOH content in foul condensate	0,021	0,008	0,017	0,006	0,004	0,002
22			MeOH flow foul condensate (t/h)	0,022	0,053	0,032	0,239	0,098	0,080
23			Concentration MeOH in foul condensate (mg/l)	2065,642	7579,795	1684,423	5781,530	3646,239	2499,348
24			Yn+2, MeOH content in ventilation	0,016	0,047	0,007	0,026	0,030	0,021
25			K' on vapour foul side	7,700	6,249	3,923	4,477	8,196	8,411
26			Kontroll (massbalans på black box, ska bli =1)	1	1	1	1	1	1
27			Kontroll (komponentbalans på black box, ska bli =1)	1	1	1	1	1	1
28									
29	Bottom compartment	Effect 2	FF-Rfx	Effect 3	Flash cond.	Effect 4	Effect 5	Effect 6	Effect 7
30	MeOH content in inlet liquor flow	1,1E-05	2,1E-05	3,7E-05	4,4E-05	5,2E-04	3,0E-04	1,7E-04	8,7E-05
31	K' value	8,1E+00	8,1E+00	8,2E+00	8,4E+00	8,4E+00	8,6E+00	8,8E+00	9,1E+00
32	MeOH content in outlet vapour, yf	4,9E-05	8,6E-05	1,7E-04	3,1E-04	2,5E-03	1,4E-03	7,7E-04	3,7E-04
33	MeOH in outlet vapour (t/h)	2,2E-03	5,5E-03	1,6E-02	6,8E-03	3,5E-01	1,9E-01	1,0E-01	5,4E-02
34	MeOH content in outlet liquor flow	6,1E-06	1,1E-05	2,1E-05	3,7E-05	3,0E-04	1,7E-04	8,7E-05	4,1E-05
35	MeOH in outlet liquor flow (t/h)	2,2E-03	4,4E-03	1,6E-02	3,2E-02	3,9E-01	1,9E-01	9,0E-02	3,6E-02
36	Kontroll (komponentbalans på bott	1	1	1	1	1	1	1	1

Figure H.1: Image of project model.

Equations for n=1, two eq. steps, iterative calculations				
Effect 5				
variabler				
Xn	0,000588	Tot.komponentbalans ren sida	eq1	0
Yn+1	0,006763	komp.balans(steg n+1)	eq2	0
Vn	91,799051	jmv. Steg n+1	eq3	0
yn	0,003762	kondensering i steg n+1	eq4	0
Ln+1	48,286365	komp.balans steg n	eq5	0
Xn+1	0,001057	jmv. Steg n	eq6	0
		massbalans steg n	eq7	0
		black box komponentbalans	eq10	7,63278E-17
			Test	
			diff	diff^2
		Önskat värde för eq		
	eq1		0	0
	eq2		0	0
	eq3		0	0
	eq4		0	0
	eq5		0	0
	eq6		0	0
	eq7		0	0
	eq10		0	7,63278E-17
			sum av diff^2	5,82594E-33

Figure H.2: Image of project model where the solver solutions where set up for effect 5.

I Variation of ventilation flow

Table I.1: Relative difference of sample results and project model values depending on changes made to ventilation flow.

Name of point	Relative difference between sample result and simulated value by project model		
	No change of ventilation flow	20% increase of ventilation flow in each effect	20% decrease of ventilation flow in each effect
3.a	-7%	-8%	-6%
3.b	-3%	-9%	3%
Flash cond.c1	-10%	-11%	-9%
Flash cond.c2	5%	-6%	19%
Vent.cond.c	-7%	-17%	5%
4.a	1%	1%	1%
4.b	-8%	-11%	-5%
5.b	-8%	-8%	-7%
5.c	-11%	-14%	-7%
6.b	-4%	-4%	-3%
7.b	-11%	-12%	-11%
Surface cond.b	-16%	-14%	-18%
Surface cond.c	-43%	-37%	-51%

J Methanol flow comparison

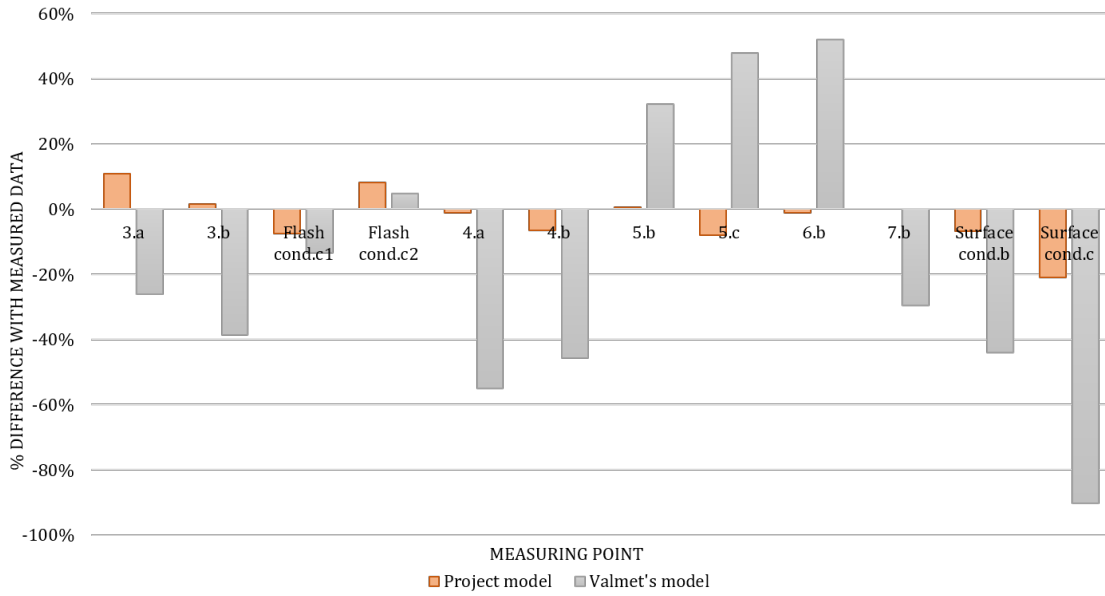

Figure J.1: Percentile difference of the methanol flow (kg/h) in condensates estimated from project and Valmet's model when related to sampling data, 910 t/h case.

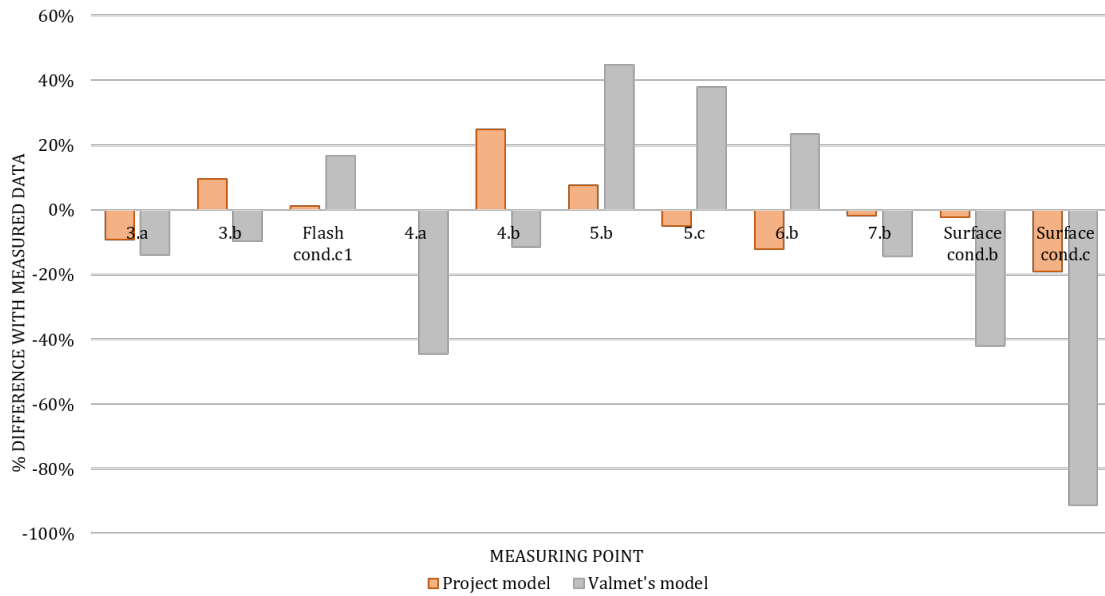

Figure J.2: Percentile difference of the methanol flow (kg/h) in condensates estimated from project and Valmet's model when related to sampling data, 610 t/h case.