

# CHALMERS

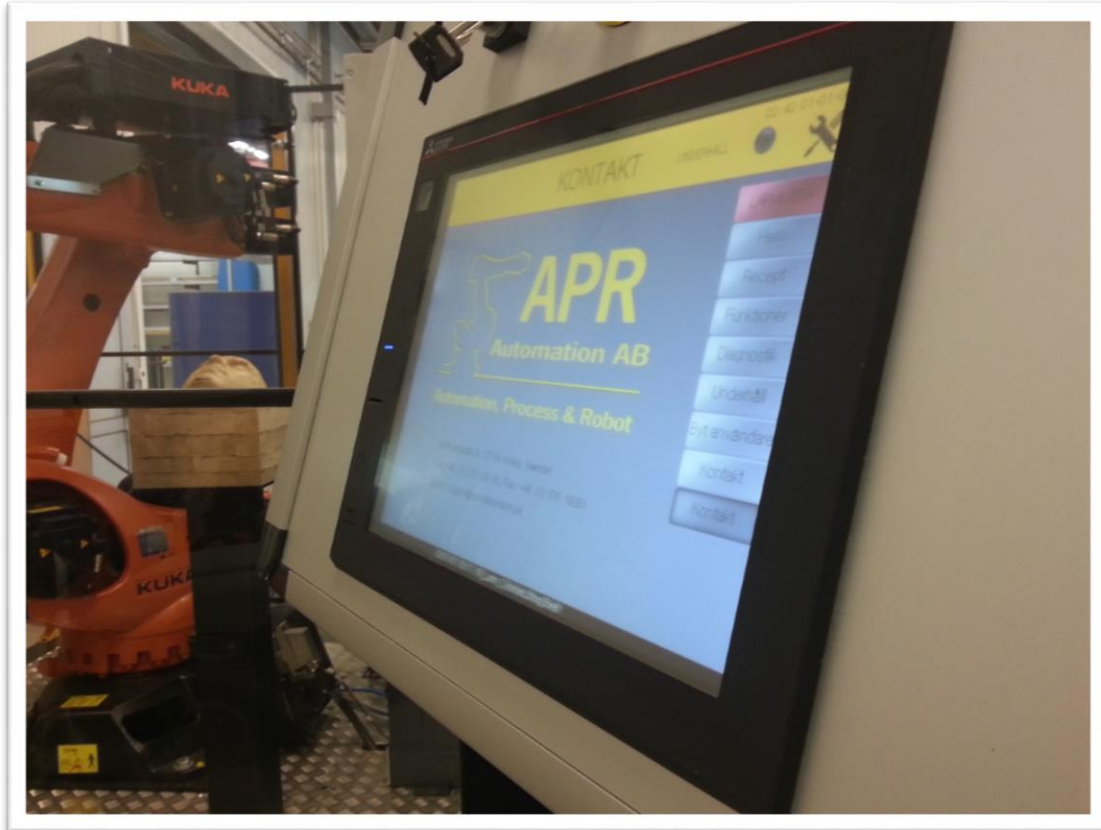

## ***Development of an HMI standard for APR Automation.***

**Master of Science Thesis in the Master Degree Program, Production Engineering**

**PONTUS WIKHOLM**

Department of Product and Production Development

*Division of Production Systems*

CHALMERS UNIVERSITY OF TECHNOLOGY

Gothenburg, Sweden, 2014

Master's Thesis 2014

MASTER'S THESIS 2014

# Development of an HMI standard for APR Automation.

Master's Thesis in Production Engineering

PONTUS WIKHOLM

Department of Product and Production Development

*Division of Production Engineering*

CHALMERS UNIVERSITY OF TECHNOLOGY



## ABSTRACT

---

**Keywords: Company growth, HMI, Standardization, Interface, APR Automation**

When smaller companies grow bigger in a short period of time, the structure and efficiency of the company can be compromised. In these cases the way that the organization operates might have to change in order to fit the new size of the company. The rapid increase of employees can be a source of many internal problems for a company. One way to counter this type of problems is to implement standards for the main tasks that the company perform. This type of efforts, should ease the communication between the personnel. Especially in periods when a lot of temporary employees are used to cope with high resource demands.

This master's thesis has the primary objective to develop an HMI standard for the company APR Automation. A secondary aim is to test and evaluate the standard on a robot cell for the Automation Exhibition in Jönköping 2014.

In this thesis it is described how the HMI standard is developed and successfully delivered to APR Automation. The thesis work also takes part in the construction, manufacturing and programming of a full sized robot system for the Automation Exhibition 2014 in Jönköping. One of the main reasons for including this Exhibition machine in the thesis, is for it to serve as a test platform for the new HMI standard. The APR machine for the exhibition did its job as a test platform for the standard and it worked as intended. The standard itself did also get finished and has been delivered to APR Automation. Much future testing, evaluation and development of the standard is required before using it as the main HMI framework for all of APR's future customer projects.



## ACKNOWLEDGEMENT

---

This master's thesis is the result off 20 weeks and 30 credits of studies and development work, at the company APR Automation. The thesis was the final project in the Production Engineering program at Chalmers University of Technology. During the thesis I learned very much and very much was also achieved. This would not have been possible without a few key persons.

Dr Henrik Kihlman, researcher at Chalmers, has been both the supervisor and examiner for the project. I would like to thank the following persons, from the company, Karlstad University and from Chalmers.

*Thank you all for your support and for being the important sources of knowledge that you all have proven to be throughout this Master's Thesis project!*

### ***APR Automation***

Christoffer Aronsson	Jonas Arne	Per Ehrencrona
Andreas Pålsson	Ola Skoglund	Bengt Lissåker
Lars Evert Wikholm	Sven-Erik Fager	Sebastian Tellwe

### ***Chalmers University of Technology***

Henrik Kihlman  
Cecilia Berlin  
Lars Ola Bligård

### ***Karlstad University***

Per Ehrencrona

*Karlstad, June 2014*

*Pontus Wikholm*



## TABLE OF CONTENTS

---

1	Introduction .....	1
1.1	Company Introduction .....	1
1.2	Background.....	2
1.3	Problem definition .....	2
1.4	Purpose .....	3
1.5	Objectives.....	3
1.6	Deliverables.....	3
1.7	Scope .....	3
1.8	Disposition.....	4
2	Theory .....	5
2.1	Automation .....	5
2.2	APR Machine .....	6
2.2.1	Typical components of the apr machine.....	7
2.2.2	Communication between the components .....	8
2.2.3	HMI.....	9
2.3	Software and hardware used in this thesis.....	10
2.4	Standardization .....	12
3	Method.....	13
3.1	Design process for a user interface.....	13
3.2	Detailed design of a HMI Standard .....	15
3.3	Data collection Methods .....	17
3.3.1	Observations .....	17
3.3.2	Interviews.....	17
4	Realization of the new HMI standard .....	18
4.1	Design of the HMI Standard .....	18
4.1.1	Conceptual model .....	18
4.1.3	Chosen components.....	21
4.1.4	Development of a user interface .....	22
4.1.5	Actual Screen Design.....	24
4.1.6	Detailed design of apr standard HMI .....	25
4.1.7	Functions .....	27
4.2	Elmia Automation Exhibition 2014.....	31
4.2.1	Project initiation.....	31
4.2.2	Robot cell konstruktion .....	34
4.2.3	Programming.....	36



5	Result and evaluation.....	37
5.1	HMI Standard .....	37
5.2	Elmia Automation exhibition 2014.....	37
6	Discussion.....	40
6.1.1	Component selection .....	40
6.1.2	The software GT Designer3 .....	40
6.1.3	Development procedure and method .....	42
6.1.1	HMI Standard for APR Version 1 .....	42
6.2.1	KUKA CNC.....	43
6.2.2	Communication protocol issue .....	43
6.2.3	KUKA Safe Operations .....	44
6.3.1	Company growth .....	45
6.3.2	APR Standard.....	45
7	Conclusion and recommendations.....	46
8	References.....	47



## TERMINOLOGY

---

AC	–	Alternating Current.
APR	–	Automation Process and Robot.
Blue collars	–	Operator who performs manual labor.
CAD	–	Computer Aided Design.
CAM	–	Computer Aided Manufacturing.
CE tag	–	The letters CE are short for Conformité Européenne according to an agreement with the EG-directives. CE is a certificate that stands for that the product does not violate safety, health, environment or function
CEDOC	–	A tool for structuring up the work around CD certification. The acronym stands for CE-Documentation.
DC	–	Direct current.
Ethernet	–	Computer networking technologies for local area networks.
G code	–	This type of code is most commonly used in CNC machines.
HMI	–	Human Machine Interface.
KRL code	–	Robot code for KUKA robots.
KUKA	–	One of the world's largest industrial robot supplier.
MELSOFT	–	A subsidiary company to Mitsubishi responsible for software development.
OP	–	Operator Panel, this is a synonym to HMI in the automation industry.
PLC	–	Programmable Logic Controller, programmable digital control unit.
Print screen	–	This function will on a Windows computer save the users current view to a bitmap image.
PROFISAFE	–	PROFIsafe is a safety communication technology for distributed automation.
RGB slide	–	RGB colors are named after the base colors red, green and blue. From combining these three a big range of colors can be achieved.
Solid works	–	Solid works is a 3d-CAD software.
VNC	–	Is a technique for sharing screens between components on a LAN (Local Area Network).
White collars	–	A worker who performs professional, managerial, or administrative work.



# 1 INTRODUCTION

---

## CHAPTER INTRODUCTION

*This thesis work is carried out as a project at APR-Automation, a small-sized automation company in Arvika. This chapter will introduce the reader to the company and provide a background to the master thesis project.*

---

### 1.1 COMPANY INTRODUCTION

APR Automation specializes in automation systems towards a wide range of industries. The company takes responsibility for the whole construction chain from project planning, through construction, programming, manufacturing, assembly, startup and finally documentation and education of the operators. Seen to both number of employees and turnover the company has grown with about 300% over the past three years.

The company has also invested in their own processing machines in order to keep as much as the production as possible under the same roof. The intention of this strategy is to shorten lead-times and reduce expensive outsourcing. APR's biggest challenges at the present lies in, increasing the personals skill as well as improving organizational processes. The work of standardizing several of their work procedures is probably one of the most important improvement projects for the company at this time. Figure 1 shows the APR logotype that consists of the three core competences of the company, Automation, Process and Robot.



FIGURE 1, APR AUTOAMTION LOGOTYPE

## 1.2 BACKGROUND

The rapid growth of APR has resulted in a rapid increase in staff. In order to meet high resource demands from big projects, agency workers and other temporary staff has also been repeatedly used by the company over the past three years. In figure 2, a bar chart over APR's personnel for the past six years is displayed. The light gray represent White-collar workers and the darker color represent the Blue-collar workers.

Also worth mentioning is that APR has had a high employee turnover ever since the company's inception. Early into 2014 APR passed 100 employees over time. There are probably several reasons for this but it can be safely said that a high employee turnover is bad for a small sized company. Especially for a company that has such high distribution white-collar workers that need a lot of training and experience in order to perform well.

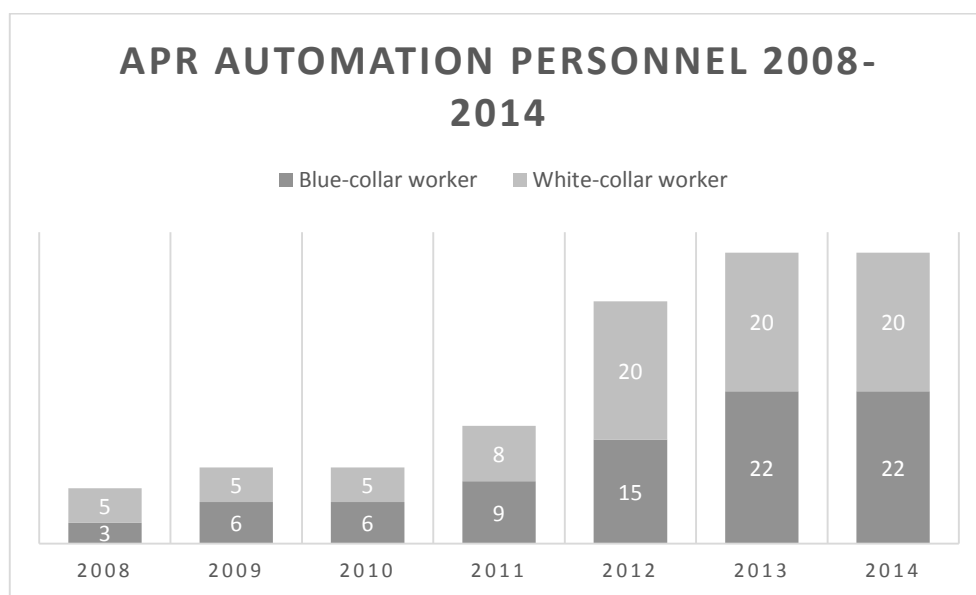

FIGURE 2, BAR CHART OVER APR'S STAFFING 2008-2014. BLUE COLLAR WORKERS ARE REPRESENTED BY THE DARK GREY COLOR AND WHITE COLLAR WORKERS ARE REPRESENTED IN THE LIGHTER TONE.

## 1.3 PROBLEM DEFINITION

When new people engage projects without a proper framework for their task they will require a lot of tutoring in order to start working. The quality of their work will also be lacking since APR has been missing a standard procedure for a lot of tasks. The development process for the PLC program, the robot program and for the HMI program could look very different from project to project.

A second problem for APR is that many customers had their own preferences on what components and subcontractors to use for their new machine (robot cell or similar APR product). This could be the case even though the customer didn't have any good knowledge about the specific branding that he/she requested. Thus many times their requirements lead to more work for APR and lower quality on the system as a whole compared to if APR would have made the selections by themselves. In order to convince customers that APR makes a more preferable selection of components to their systems APR want to create their own standard APR machine.

## **1.4 PURPOSE**

APR want to standardize how an APR machine is built. In order for the customer, to get a competitive price and high quality on an APR product, the customers would have to accept the APR standard components. Also there should be no ambiguities of how an APR machine is projected, built, programmed and documented. Not even for temporary employees.

The development of this standard is an extensive, ongoing work that had to cover every part of the APR product. The areas that have been given primary focus and have engineers assigned to standardize them are robot, Programmable Logic Controller (PLC) and Human Machine Interface (HMI). The standards would include a selection of hardware and supplier, but also a method description of how APR should work with the specific area.

The HMI is a highly important part of the product that APR delivers since it serves as the interface and connection between the operator and the machine with all its separate components. It is also a highly visible component for higher management at the customer's factory. Thus it is an important part to prioritized design on for marketing reasons as well.

## **1.5 OBJECTIVES**

The primary objective of this master's thesis project, is to develop a concept of a standard HMI program. This is the main interface that an operator has towards the APR machine.

The second objective is to develop, build and program a robot cell for the Elmia Automation Exhibition in Jönköping. At the exhibition the HMI standard will be displayed and evaluated by the exhibition visitors.

## **1.6 DELIVERABLES**

The main delivery of this master's thesis work is a standard concept for an HMI-panel to APR's machines. This is the theoretical phase of the project. The more practical phase will be to design and program a robot system for an automation exhibition in Jönköping. This robot cell will also serve as a testing platform for the developed HMI standard. A documentation of the HMI including hardware, software and instructions are also to be delivered to the company.

## **1.7 SCOPE**

An overall process of standardizing the whole APR machine is ongoing in the company. The thesis scope was limited to creating a concept of a HMI-panel standard. In this thesis a HMI-panel will refer to the operator panel and not to the HMI of the robot, which also is called the robot pendant. The length of the study was 20 weeks; start date was set to 2014-01-20 and finalization and presentation to 2014-06-13. Testing the standard will be done as soon as possible in new projects. An important test was to use the standard on an APR machine at the automation exhibition in Jönköping 6-9 May. After that the usage and further development of the standard was handed over to the company.

## 1.8 DISPOSITION

The thesis work that is described in this master's thesis report consists of two main activities. Firstly an HMI standard was developed for the company APR Automation. Secondly a robot cell for the Elmia Automation Exhibition 2014, was projected, constructed, programmed and used by this thesis student and a student from Karlstad University with support from the company. The section below will go through the different chapters of the report to help the reader to get a clear overview of the report.

After the *introduction* chapter a *theory* chapter will follow. In the theory chapter several headlines will aim to provide the reader with a deeper understanding of the technology and systems that are treated in this thesis. This chapter is heavily reliant on literature and previous knowledge at APR.

Chapter three treats the chosen *method* in the thesis. It describes the methods used in the design phase of the HMI standard. It will also briefly go through how data has been collected in this master's thesis work.

The following chapter four is called *realization of the new HMI standard*. This chapter is the longest chapter and it goes through the workflow of the thesis work. This chapter is divided into two main parts. The first part is focused on the design of the HMI standard, the second part describes the construction, programming and usage of the APR machine for the Elmia Automation fair 2014.

Chapter five, *Result and Evaluation*, has the same division as chapter four between the HMI standard and the Elmia Automation Exhibition 2014. It covers the thesis result in a short and focused way.

Chapter six, *Discussion* brings up problems and challenges throughout the thesis work. Some opinions have got a place in this chapter but for the most they are well motivated and based on facts.

Chapter seven, *Conclusions and Recommendations*, this chapter is the shortest one in the thesis and it includes some recommendations from the master's student to the company and a compact section of conclusions from the completed thesis.

Chapter eight, *References* contains a list of references to the literature that this thesis quotes.

Finally an appendix is attached with pictures from the development process and usage of the APR machine for the Elmia Automation Exhibition 2014.



### CHAPTER INTRODUCTION

*This chapter will provide the reader with a deeper understanding of the type of systems that APR builds. It will also cover standardization and a few HMI design conventions. Bryman and Bell discuss the importance of carrying out a thorough literature study in any scientific report. This provide the reader with a truthful background to what that has been done previously within the same field. In most real world projects the focused area changes along the way and therefore a continual literature research is of importance to efficiently keep working with the correct things. (Bryman & Bell, 2011)*

---

### 2.1 AUTOMATION

Automation is a way to make a process function automatic without continuous control or input from an operator. It will in many cases replace or streamline human labor, this labor however is most commonly high load and consisting of many monotonic tasks. Many have argued both for and against the ever-increasing automation of the world's industries. Some pros of automation are speed, increased output, precision and higher quality. On the other side automation can bring the human too far away from the actual process, knowledge and skill can be forgotten and the trust in the automatic system can be too high or too low (Bohgard, 2011).

One of the most discussed subjects under automation is probably the question if automation is a threat to human jobs. One of the most recent articles on the topic is (FT.com, 2014). It brings up three main arguments for Automation which are posted below.

“

First, the world has lived - and economies have prospered - through similar changes in the past. As Mr Summers noted, fortunes accrued to tycoons such as Andrew Carnegie and John D Rockefeller in the late 19th century phase of globalization and technological advance, but the benefits later spread.

Second, humans have a remarkable ability to adapt to technology. The race against automation pushes them to improve education and to create new jobs requiring human interaction, and the ability to innovate. In the late 20th century the educational emphasis was on science and technology; in the 21st, it may turn to a combination of technical and creative skills.

”

“

Third, a reduction in the amount of work done by humans need not be a bad thing. Economists have predicted an age of leisure before; in practice, many people work longer hours than a generation ago thanks to instant communications and globalization. A greater sense of balance would be welcome.

If automation does eliminate higher-level jobs - still a big if - societies will have to adapt. It would mean thinking in new ways about how to distribute the benefits of technological advance, as well as the hours that humans spend at work. The nations that get the equation right will be the wealthiest and the most stable.

”

There are different levels of automation, from the lowest level which is entirely un-automated, where humans are needed for both decisions and physical work. To the highest level where computerized systems take over both decision making and physical actions entirely without human interaction. The most common level is a rather high level, but the system will need human involvement as soon as the process needs to be changed or repaired (Bohgard, 2011).

## 2.2 APR MACHINE

The type of automation systems that APR-Automation builds can look very different depending on the type of industry the customer works with. Most commonly an APR machine includes industrial robots, conveyors, electric or pneumatic equipment and safety equipment in their systems, but much more can be added in order to handle or machine the customer's product in the way that the customer wants. Figure 3 provides an overview of a system that APR has delivered eight times to the same customer. The system is called R400 and what it does is basically handling of all IKEA's painted MDF, kitchen doors. Four machines are located in Sweden and four machines are located in Portugal.

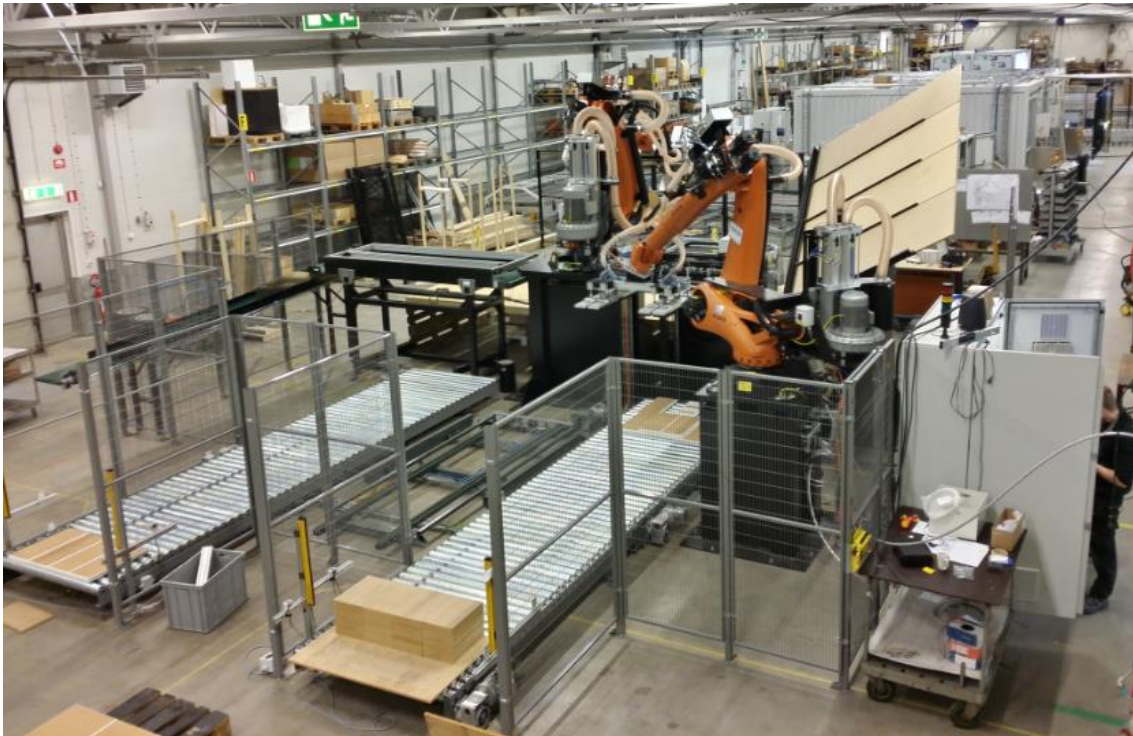

FIGURE 3, R400 INSTALLED IN APR'S PREMISES TO BE RUN-IN BEFORE IT IS PACKED UP, MOUNTED AND TESTED FOR ACTUAL PRODUCTION, ON SITE AT ONE OF IKEA'S FACTORIES.

### 2.2.1 TYPICAL COMPONENTS OF THE APR MACHINE

The R400 system is a smaller sized machine compared to many other APR deliveries. Still it consists of many dissimilar components and techniques. All the parts in the system has to interact in the right way, in order to fulfill its purpose and produce high quality products. Below follows table 1 with the main components of the R400 system. This is just to give some insight in how a specialized machine like this is built and what it consists of.

TABLE 1: A TABLE OF THE MAIN COMPONENTS IN THE R400 APR MACHINE (APR, 2014)

Component	Description	Amount
KR 120 R3900 ultra K (189662)	Industrial robot including KRC4 controller and cable system	1
KR 180 R3500 ultra K (189621)	Industrial robot including KRC4 controller and cable system	1
Gripper Assembly for KR 180	Vacuum grippers cc20-20 type Unigripper from Tepro Machines. Mounted on APR structure and each pare of gripper plate floating in x-y for corect positioning of the door in the CNC machine.	8
Gripper Assembly for KR 120	Vacuum grippers cc20-20 type Unigripper from Tepro Machines. Mounted on APR structure and each pair of gripper plate floating in y for corect positioning of the door located in the stack and on the Pick and scrape device.	4
Robot pillars	Pillars for KR 180 R3500 ULTRA K	1
Robot pillars	Pillars for KR 120 R3900 ULTRA K	1
Chain conveyors	Transportation conveyor for pallets with goods	4
Conveyor drives	Drivers for the chain conveyors	4
Fans for gripper	1x 11KW (KR 180 R3500), 1x 7,5KW (KR 120 R3900)	2
Separation ruler with linear operation	Separation of scrap and doors (vitrin doors)	1
Pick and scrape	Elevating machine for seperating the products.	1
Intermediate station	Intermediate station makes the location of the doors corect	1
Fence and safety	Fence and doors for protection towards the operator	1
Lightbeam with stand	Light Beams are used their material is entering/moving out from the cell.	2
Muting	The Muting system is a number of sensors located around the light beam. The system is ensuring automatic transport of material and is also making sure that a human can not enter the cell without the safety system alarming and safety stop acoure.	1
Safety PLC	This is a PLC dedicated to controlling the safety system (door looks, light beams, safety signals from different equipment, safety stop buttons, etc, etc.) surrounding the harmful equipment. The safety system have a special standard that	1

	require dual-channel safety to ensure the security of the personnel, working with the machine.	
Electric components	All electrical components are located in electrical cabinets. Below list is mainly components located in the main cabinet.	1
PLC	Programmable Logic Controller. Control unit for all communication in the cell.	1
Ethernet card for internal network	Ethernet card for internal network. This network can be hooked up to the customer network and also to the internet for remote support, directly from APR to the customer.	1
Power supply	24V power supply for the PLC and other low voltage equipment	1
Nod 20 + 8	I/O-module, normally connected to a bus system (eg. ProfiBus or equal) for communication between sensors, valves gages, ect. and the PLC	2
ProfiBus master/slave	ProfiBus master for the PLC and slave for the robots	3
Screen 12"	The main operator panel (OP) is normally integrated in the main electrical cabinet. The operator HMI is made on this screen. The operator is selecting programs, making adjustments and monitoring statistic data on this screen.	1

### 2.2.2 COMMUNICATION BETWEEN THE COMPONENTS

An APR machine includes, as previously mentioned, a variety of components and many of them need to communicate with other parts of the system. This is normally solved with the use of a PLC which is an industrial computer that specializes in control of automation and electromechanical devices.

#### PLC



A PLC is a microprocessor that depending on the price and performance class can handle different numbers of input- and output signals to and from other devices and components in the robot cell (Collins, 2007). The plc itself is a small rectangular box that is mounted on a base unit together with other modules. One example of an important module is the electric power supply (the red device in figure 4). Another important module is the I/O module. In this project input signals from the sensors and output signals to the pneumatic cylinders are hard wired to an I/O module that is connected to the PLC via PROFIBUS (the purple cable in figure 4).

FIGURE 4, THE PLC USED IN THE MASTERS THESIS PROJECT.

## *FIELD BUS TECHNOLOGY AND COMMUNICATION PROTOCOLS*

If two devices are going to exchange information it is a necessity that they both speak the same language (communicate in the same way). Also that they try to send/receive at the same time. Fieldbus is the generic name of industrial computer network protocols which are standardized under the field bus standard, IEC 61158. Network protocols or communication protocols, are sets of rules that make sure that messages and errors that are sent from one device, always will reach the intended receiver. It is also important that the two devices baud rates are synced. This to ensure that no miscommunication occurs. (Popovic, 2006)

PROFIBUS is a field bus developed by Siemens and it is the dominating communication protocol in Germany and in middle Europe. CC-link is another field bus which is developed in Japan by Mitsubishi and DeviceNet is big in North America mainly because it is developed by the American company Rockwell Automation.

There is also a number of newer communication protocols that use industrialized Ethernet (computer networking technologies for local area networks.) to increase the flexibility and communication possibilities compared to the older ones mentioned above. Some examples of communication standards that use Ethernet are; EtherCAT, PROFINET and EtherNet/IP (Drivtechnik, 2007-2014).

## *FREQUENCY CONVERTERS*

The purpose of a frequency converter (FC) within this field, is typically to control the speed and the torque, of alternating current (AC) motors or integral motor spindles. This is done by converting AC of one frequency to AC of a different frequency to increase or decrease the rotation rate of the motor. The frequency of the Swedish electricity grid is supposed to be 50 Hz. On that frequency a typical AC motor will only run in one set speed. Today the frequency of the current in the Swedish electricity grid, only deviates by a maximum of +/- 0.1 Hz from the desired 50 Hz (Wänlund, 2012). However a high quality FC has a much higher accuracy on the output current frequency. Typically a FC has a variety of functions. For example the FC typically has a built in over voltage protection that lets the user set an over voltage allowance that is suitable for the particular application. (Abele, et al., 2010)

### **2.2.3 HMI**

A way for an operator to monitor and control this equipment needs to be provided. This is where the HMI or as it more practically is called, the operator panel comes in to the picture. The HMI is a crucial part of the machine, since it is the only direct link between the operator and the machine as a whole. An interesting aspect for this component, is that it is often not the hardware that needs to be replaced on a bad HMI. Poorly designed HMIs has been identified as factors contributing to abnormal situations, billions of dollars of lost production, accidents and fatalities. In fact many HMIs becomes more of a hindrance then assistance to the operators (Gruhn, 2011).

The HMI panel used in this project can communicate with the PLC either through serial communication (RS232, USB or RS422), via Ethernet (RJ45), through a CC-link (RS485) or wirelessly. In this project Ethernet was chosen for the communication between HMI and PLC. The HMI design is made in the MELSSOFT software GT Designer3. (Mitsubishi Electric, 2013)

### 2.3 SOFTWARE AND HARDWARE USED IN THIS THESIS

Table 2 below brings up the prime components used in the APR machine for the Elmia Automation Exhibition 2014. The most central of all the components is the industrial robot. Without the robot, the rest of the components will not be able to fulfill their purposes. The PLC will follow the robot in importance, since it controls all other logic and equipment in the machine. The HMI is the interface from the machine towards the operator and the main control unit for the operator towards the machine. The task at hand required several pneumatic tools for fastening and handling the product. A vision camera was also needed to identify the orientation of the products. The spindle motor has another central role in order for the machine to perform the desired task. In addition to these parts the system needs a lot of peripherals as safety equipment like fences, a safety camera, a lock and a safety PLC. Steel beams for the framework was needed as well as cable trays, electric cabinets, enclosure for the HMI, modules for the PLC and a floor of checker plate to walk on. Following table 2 will be table 3 that contains the main software used in the thesis project.

TABLE 2, THIS TABLE LISTS THE MAIN COMPONENTS USED IN THIS PROJECT, IN THE APR MACHINE FOR THE ELMIA AUTOMATION EXHIBITION 2014.

Component	Description
<b>Robot</b> - KUKA KR 120 R2700	Six axis Industrial robot, maximum load 120 Kg, KUKA.
<b>Robot cabinet</b> - KUKA KR C4	Robot cabinet, KUKA.
<b>Armature</b> - SAWJH1SL	Armature for the operator panel, Eldon.
<b>Electric cabinet</b> - MAS1008030	Electric cabinet, Eldon.
<b>Enclosure for HMI</b> - OICP395220	Enclosure for HMI and rear panel, Eldon.
<b>PLC</b> – Q03UDVCP	The PLC Q-series from Mitsubishi are built to be highly modular and flexible. There are several specialized CPU's to meet different requirements and lot of different other modules to add on to the base unit to meet special requirements. (Sandberg, 2013) PLC Q Series iQ CPU module; 4096 EA;1.9 ns/log. Com.;30k steps; Ethernet; USB; SD
<b>HMI</b> - GT2712-STBD	HMI, graphic operation terminal, GOT2000-series, Mitsubishi electric.
<b>Base unit</b> – Q38DB	PLC Q Series Base unit iQ CPU, power supply, 8 I/O slots
<b>Power supply</b> – Q61P	PLC Q Series Power supply 100-240 V AC input, 5 V DC 6 A output
<b>Profinet IO Controller</b> - ME1PN1FW-CCPU	PLC Q Series; Profinet IO Controller
<b>Frequency converter</b> – FR-A840-00126-2-60	Inverter; Rated Power: 3,7kW; 3x380-500V; Rated Current: 9A; IP20
<b>Radio Noise Filter</b> - FFR-BS-00126-18A-SF100	Radio Noise Filter for FR-A&F-00023-00126; C1 20m; C2 100m
<b>Profinet adapter to the frequency converter</b> - A8NPRT_2P	Profinet RT 2port Interface for FR-A/F800 with Drive Profile

<b>Spindel</b> - Colombo RA 73	Machining spindle from Colombo, 40 000 rpm, 3 HP, 480 V, 2.2 kW
<b>Engraving tool</b> - LSAB V Slotting mill	Milling tool for engraving in soft materials. D=12.7mm V=60deg
<b>Turning gripper</b> – HGDS-PP-12-P-A-B	Pneumatic turning gripper from FESTO.
<b>Air Preparation</b> – MSB6-AGD:C4:J12:V34-WPB	Air preparation from FESTO for the pneumatic equipment.
<b>Parallel gripper</b> – DHPS-10-A-NC	A small, pneumatic and parallel gripper from FESTO.
<b>Milling fixture</b> – DFM-12-20-P-A-GF	A milling fixture is put together of several FESTO components.
<b>Vision camera</b> - FQ2-S45100N	Vision camera for advanced inspections with built in LED-lighting and many functions embedded. With software included.
<b>Security camera</b> – QIHAN CCD COLOUR CAMERA SONY	Qihan CCD color camera Sony 1/3" 600TVL, BNC-connection.
<b>Safety fence</b> – Smart fix	Safety fence from TROAX with Plexiglas, the type is called Smart fix.
<b>Safety lock for door</b> - Euchner MGB	Safety lock from Euchner with three buttons. One to request access, one for resetting safety and one for emergency stop.
<b>Safety PLC</b> - PLUTO B46	Safety PLC from ABB's safety department Jokab. Number of I/O: 46
<b>Steel beams</b> - EO-stål	Steel beams for the construction of the framework. Several VKR beams of different dimensions were used.
<b>Aluminum checker plate</b> - WIPAB AB	Aluminum checked plate for the floor of the robot cell, water-cut by the company WIPAB.

TABLE 3, THIS TABLE LISTS THE MAIN SOFTWARE USED IN THE PROJECT

Software	Description
<b>GOT Screen Design Tool</b> - GT Designer3 Version 1.108N	GT Designer3 is a complete HMI programming, screen creation, and maintenance program. In order to reduce the labor required to create detailed and impressive applications, the software's functionality has been built around the concepts of ease of use, simplification (without sacrificing functionality), and elegance (in design and screen graphics). (Mitsubishi Electric, 2013)
<b>PLC programming software</b> – GX Works2 Version 1.499V	GX Works2 represents the next generation in MELSOFT (see Terminology, page 1 for description of the acronym) PLC maintenance and programming software. Its functionality has been inherited from both GX and IEC Developer, with improvements made throughout to increase productivity and drive down engineering costs. (Mitsubishi Electric, 2013)
<b>Robot code editor</b> - OrangeEdit Version: 2.0.8	Category: Windows App, Released: 2014-04-22, Language: English, Deutsch, Requirements: Win XP,Vista,7,8(x86,x64), .NET 3.5
<b>Vision programming software</b> – TouchFinder for PC	Touchfinder is a software developed by OMRON for setting up and programming their vision cameras.

**MasterCam X7** – CAD/CAM software  
for material processing (see  
*Terminology, page 1 for description of  
the acronyms*)

MasterCam X7 was used together with the extension RobotMaster.

---

The software in the table above are the two software needed for the programming and design of the PLC, HMI, Robot and Vision camera.

## **2.4 STANDARDIZATION**

Both Henry Ford and Taiichi Ohno proclaimed that, *“without a standard there can be no improvement – no development, no evolution of the organization and its systems.”* (Huntzinger, 2007) Still standardization brings a bad taste to many peoples mouth. It reminds them of “big brother”-like engineers with stopwatches that make sure the employees work hard enough and follow every rule. There are off course reason for their suspicions but that does not have to be the case. The standardization at a work place should benefit the workers, since it describes the best way known to perform a series of work tasks. The standardization of a work task should be balanced to a reasonable workload so that the system in the end becomes as stable as possible. Depending on how complex, how repetitive and how critical a work task is, different degrees of standardization are suitable. For example it is not always necessary to make time studies on all types of processes or tasks. Standardization should however always provide a structure to the task, help avoid misunderstandings and lower the learning time for new employees (Liker, 2006).



#### CHAPTER INTRODUCTION

*This chapter will describe the methods used during the design phase of the HMI design. It will also provide the reader with some brief information on how the data collection has been carried out throughout the master's thesis work.*

#### 3.1 DESIGN PROCESS FOR A USER INTERFACE

Lars-Ola Bligård describes in his book; *The development process from a human-machine perspective* a user interface development process in four sequential blocks namely; needs identification, function and task design, general design and detailed design. These blocks are visually represented by the red circle in figure 5.

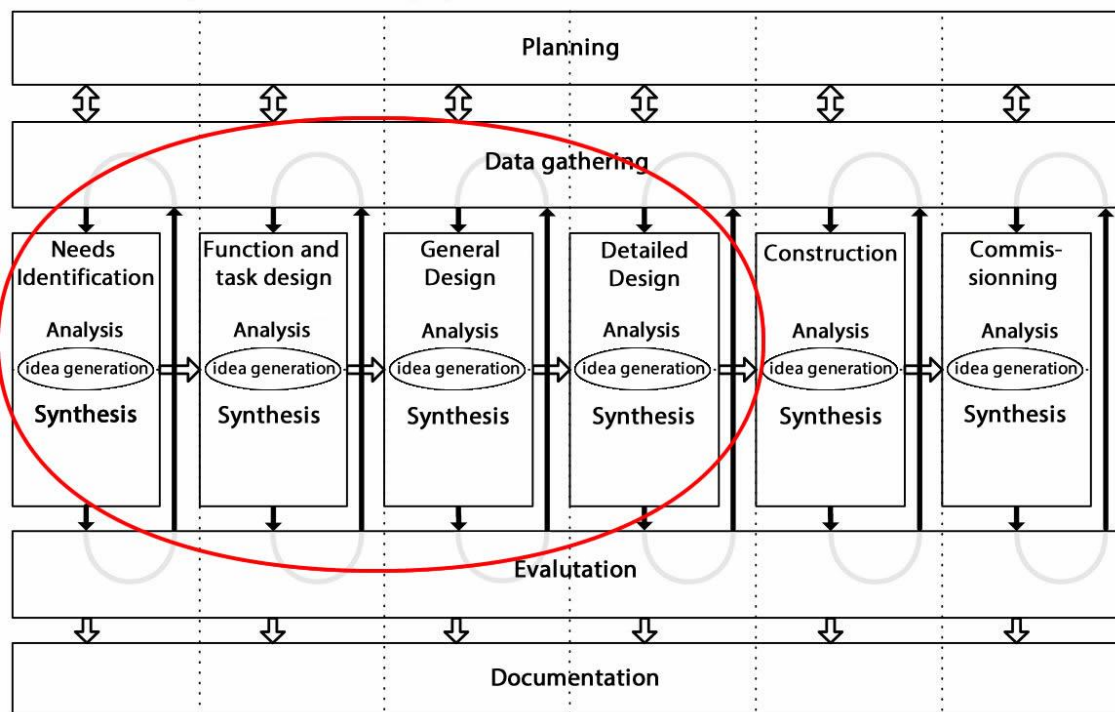

FIGURE 5, VISUAL ILLUSTRATION OF THE DEVELOPMENT PROCESS MODEL FROM THE DEVELOPMENT PROCESS FROM A HUMAN-MACHINE PERSPECTIVE. THE RED CIRCLE IS ADDED TO SHOW THE BLOCKS THAT ARE RELEVANT FOR HMI DESIGN

He has four guidelines for his design process:

1. Presume that the task is the number one priority and that it should be performed efficiently, safely and so that other system components not are damaged.
2. Presume theory in manuals, standards and guidelines.
3. Presume empiricists such as studies of users, usage environment and usage situation.
4. Bring together and integrate empirical data and theory.

If these guidelines are met the first part in the *needs identification* would be to specify the outer boundaries for the user interface.

1. Intended use
2. Intended users

3. System goals
4. Simple system description

The needs identification would be followed up with a *function and task design*. The purpose of this is to determine the elements of the interface that is independent of a physical representation. The goal is to describe the tasks that the user must perform and the functionality that the machine should have.

5. Function analysis and function allocation
6. Task design
7. Function design

The third part is the *general design*. The purpose with this part is to in general decide what the user interface is going to look like and how the interaction with the user will work.

8. Abstraction principles
9. Detailed system description
10. Technical principles
11. Overall design
12. Design guidelines

The purpose with the final part, the *detailed design* is to in detail specify how the user interface should look and work.

13. How functions should be organized
14. Detailed design
15. Instructions and manuals

(Bligård, 2011)

### 3.2 DETAILED DESIGN OF A HMI STANDARD

The detailed design of the HMI standard is based on guidelines and design principles mainly from the book; *Work and technology on the operator's conditions* (Bohgard, 2011). Below follows a bulleted list of the main design principles that the book brings up.

#### *DESIGN PRINCIPLES THAT SUPPORT ATTENTION*

- **Minimize the time and effort to find information**  
If the operator has to search for information in different screens, menus or even different displays in the room he/she will get tired, stressed and the work will be of low efficiency.
- **Closeness**  
Sometimes information needs to be processed from several sources simultaneously. For example a graph might have to be studied at the same time as status information needs to be monitored. The placement of such information should be given special notice from the designer. The usage of frames and similar colors on such information also supports that the operator gives his attention to the right source at the right time.
- **Take advantage of multiple sources of information**  
If a large amount of information needs attention the information can be more easily understood if it is transmitted through multiple sensory channels. For example information can be easier to take in if it is presented in both auditory- and visual stimuli.

#### *DESIGN PRINCIPLES THAT SUPPORT PERCEPTION*

- **Design the display with good legibility**  
Good legibility is obtained by high contrast, good lighting and appropriate viewing angle.
- **Avoid too many levels for absolute assessment of information**  
It can be hard to distinguish different information if there are too many levels or types of the same kind of information. Objects should not have more than five levels of size, height, color or thickness.
- **Avoid solely concept-driven processing of data**  
Humans perceives and interprets often signals for what they think is going to be visualized, based on previous experience. A good interfaces uses additional effects and design techniques to clearly show when something unexpected has occurred.
- **Exploit redundancy**  
It is very likely that information is more properly interpreted if the same message is displayed in more than one way. The message will become especially clear if different modalities are utilized. For example both auditory- and visual stimuli or traffic lights where the positioning of the lights and the color, mediate the information.

- **Avoid similarity between objects**  
Objects that are interpreted similar to other objects of a different kind can cause confusion and the risk of occurring misunderstandings will increase.

*DESIGN PRINCIPLES THAT SUPPORT MEMORY FUNCTIONS*

- **Knowledge in the world**  
The interface design should generally not demand that the operator holds important information in his/her short term memory. Therefore current important information, for example product numbers, checklists or reference values should all be presented on the screen. Then the operator can focus his/her short term memory entirely on actual problem solving instead.
- **Anticipate system status**  
Humans are not particularly skilled at predicting future scenarios and states of a system of events. This is proven to be a hard cognitive task. A good interface must support the operator with information and status that helps him/her to work in a proactive way rather than working reactive.
- **Consistent presentation**  
When the long term memory works well a person can easily carry out previously learnt in tasks. It is very hard to get rid of old habits. When designing a new interface awareness of this is important so that good correspondence to previous systems are designed into the new interface.

*DESIGN PRINCIPLES THAT SUPPORT THE OPERATORS MENTAL MODEL*

- **illustrated realism**  
Exemplification from reality should be used as often as possible in order to describe the intended function in the best possible way. For example if a temperature is to be displayed a thermometer should be used in the interface.
- **Display of moving objects**  
Moving objects on the screen that show dynamic information should to the maximum possible extent match the user's mental model of the system. For example a bar display for attitude in an airplane should go up when the attitude increase and down when the plane drops height.

(Bohgard, 2011)

### **3.3 DATA COLLECTION METHODS**

Data collecting is important in any real development study where all data is not given from the start. Methods can be used to gather information about all parts in a man-machine system. This often involve human judgment and opinions. All parameters that are involved in a man-machine interaction can be studied with different data gathering methods. (Bohgard, 2011)

#### **3.3.1 OBSERVATIONS**

Before the design process was initiated, knowledge and experience was needed in the project about the technology that was to be standardized. Thus a case study at a customer to APR with a machine that was still being run-in, was arranged.

##### *CASE STUDY SWEGON*

The plan for this case study was to get me involved in how APR used the HMI panels in their machines. Several visits, meetings, interviews and some simple workshops with the located APR-programmer was planned. An operator interview was also planned to get his view on the HMI usage and what features he/she believed were most important for his daily work.

##### *CASE STUDY ELMIA AUTOMATION EXHIBITION 2014*

The automation exhibition would serve as the final case study and test platform for the HMI standard. It would be a real case APR machine but less sensitive to minor bugs or even errors in its functions, then an APR machine sold to an actual customer would have been.

#### **3.3.2 INTERVIEWS**

An Interview is a versatile method of gathering information because it can be used to gather information in so many different situations (Lantz, 2007). Interviews are also the best way of gathering information of what people think and what their opinions are (Bohgard, 2011). The type of interviews that was decided best suited for this thesis project was unstructured or in some cases semi structured interviews.

##### *UNSTRUCTURED INTERVIEWS*

This type of interview can also be called an open interview. In this format both the interviewer and the interviewed person has great freedom to control, and direct the interview towards areas that he/she thinks are the most important or interesting. An unstructured interview is also better suited then structured or semi structured interview, in situations where the interviewer has lacking knowledge of the subject (Bohgard, 2011).

##### *SEMI-STRUCTURED INTERVIEWS*

This interview method is somewhat in between structured and unstructured interviews. A structure has been prepared by the interviewer. However the interviewer is free to add consequence questions, remove questions or change the order of the questions during the interview (Bohgard, 2011).

## 4 REALIZATION OF THE NEW HMI STANDARD

### CHAPTER INTRODUCTION

*This chapter has two main parts the first one is focused on the design of the HMI standard. The second part describes the robot system that was built for the Elmia Automation Exhibition 2014.*

#### 4.1 DESIGN OF THE HMI STANDARD

This section is the first part of chapter 4. It will describe the work with developing the HMI standard. The first step was to build a conceptual model for the main functions of the user interface. This process was carried out in parallel with the selection of hardware and software from amongst the many different PLC and HMI suppliers. An important part of the whole development process was for me, the master's student, to get to know the potential and usage areas for an APR HMI. This was done by conducting a case study at a nearby customer to APR.

The next step of the development process, was to connect the design conventions and development theory with the actual HMI design in the supplied software. A continuous link between the theory and the actual design was maintained throughout the development phase. The working process with the software was very much dependent on the trial and error method as well as a continuous dialog with the component providers support team.

##### 4.1.1 CONCEPTUAL MODEL

A conceptual model of the user interface was made in PowerPoint, figure 6 below provides a print screen of the conceptual model in PowerPoint. The reason for doing this was to independently of panel manufacturer, think through the functionality and design that was suitable for the APR standard. Some questions to be answered were: What different screens were recurring in the customer projects and how should the menu look?

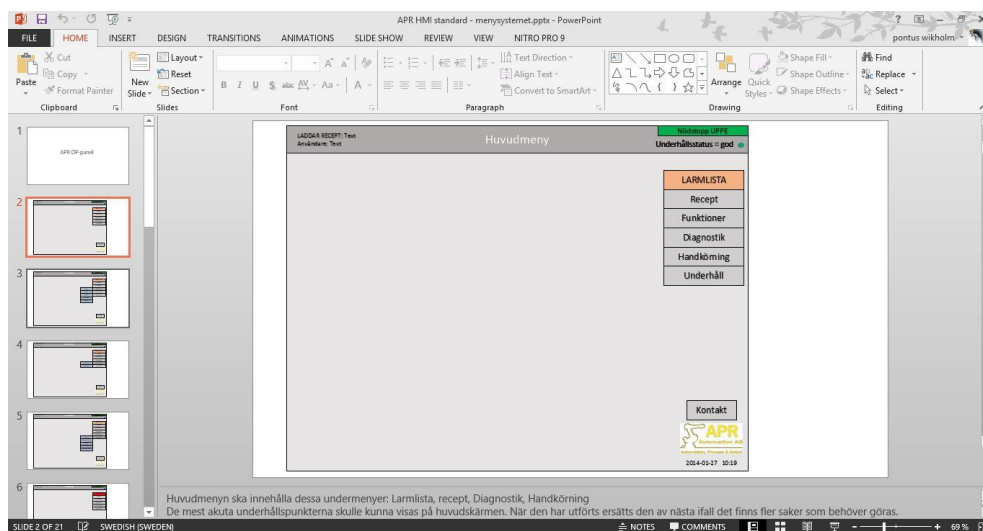

FIGURE 6, A PRINT SCREEN (SEE TERMINOLOGY, PAGE 1 FOR DESCRIPTION OF THE WORD) OF THE CONCEPTUAL MODEL IN POWER POINT

This was all reasoned about and driven forward together with the PLC programmers in several meetings at APR. The menu system is an important factor of a user interface. Below in figure 7 a graphical representation of the result of these meetings is displayed.

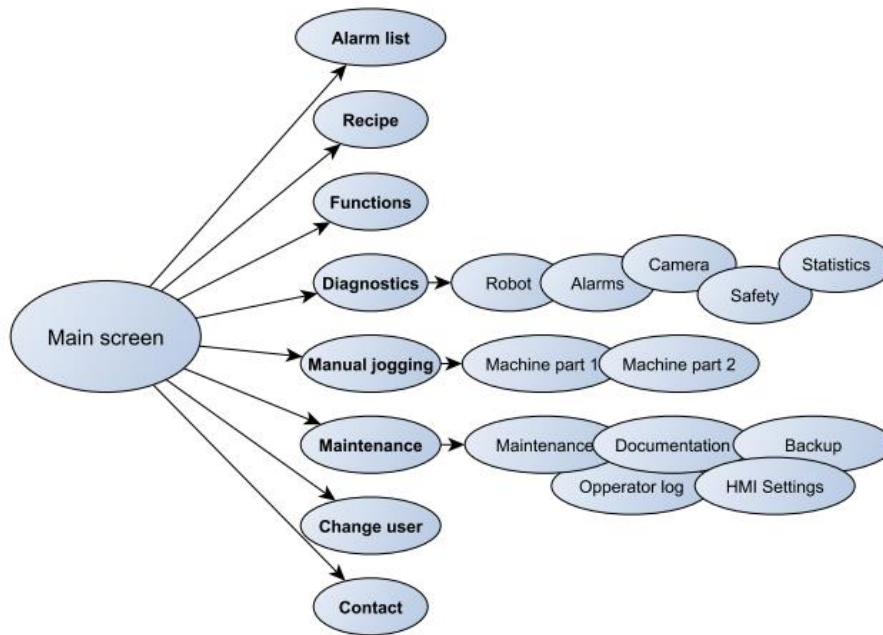

FIGURE 7, CONCEPTUAL MODEL FOR THE HMI MENU SYSTEM

Table 4 is made to describe the purpose and function of every screen in the main menu. The table is displayed below.

TABELL 4, THIS TABLE DESCRIBES THE DIFERENT SCREENS AND THEIR PURPOSES.

Screen	Purpose
<b>Alarm list</b>	This is the larm list which can be accessed either from the menu button or from clicking a popup screen that will appear when an alarm has triggered. It displays the current alarms that has not been taken care of.
<b>Recipe</b>	In a production system it is common that several recipes need to be managed in order to switch between products or variants.
<b>Functions</b>	Special functions of all kinds need a dedicated screen in the interphase.
<b>Diagnostics - Robot</b>	This screen will typically include lamps and switches for the input- and output signals. Other functions like execute buttons to robot programs and similar ar also appropriate for this scree.
<b>Diagnostics - Larm</b>	The purpose of this screen is to collect alarm history and display when an alarm went off and when it was restored or confirmed by the operator or maintenance personnel.
<b>Diagnostics - Camera</b>	In the APR standardization work a surveillence camera has been investigated for usage in some cells where the vision is blocked or for some other reason bad. In the systems that a surveillence camera is used a screen is needed for viewing, recording and playback.

<b>Diagnostics - Safety</b>	This screen should include information about safety zones, documentation of the risk analysis and other similar information and buttons.
<b>Diagnostics - Statistics</b>	Customers request more and more out of a modern automation machine. Statistics of different kinds is one of them. The sensors are in most cases already in place the only thing that is needed to fulfill this request is programming smart programs in the PLC and HMI to take care of, and display the data. Displaying this type of information is the purpose for this screen.
<b>Manuel jogging – Machine part 1 &amp; 2</b>	Manual jogging can be very useful if something goes wrong and some motors, servos, conveyors or other equipment needs to be manually run. This screen is normally simple to set up with text and buttons.
<b>Maintenance - Maintenance</b>	This screen is of great importance in the HMI standard. The top management of APR has requested maintenance functions. This screen is the location where this type of information and functions are placed.
<b>Maintenance – Operator log</b>	This screen contains a simple text log that operators can use to communicate with each other between shifts and even with APR personnel that remotely could log on to the HMI panel and check the log for special notes.
<b>Maintenance – Documentation</b>	This screen is most importantly intended for the main documentation to the machine. The manual for the whole machine you could also call it, but other general types of documentation off components and such can also be displayed on this screen.
<b>Maintenance – HMI settings</b>	This screen is for commonly used HMI settings. It also contains a link to Mitsubishi's whole suit of user settings.
<b>Maintenance – Backup</b>	The HMI can be backed up to store all present data. This page is for this kind of functions.
<b>Change user</b>	This button will open a popup window where it is possible to log on as a different user. There are several security levels in the HMI where some functions might only be available to maintenance personnel for example.
<b>Contact</b>	This page displays a big logotype and contact information to APR Automation.

---



### 4.1.3 CHOSEN COMPONENTS

The subcontractor that was selected to provide electric components like HMI, PLC and frequency converters to the APR standard was Mitsubishi Electronics. This selection was made by a group of skilled engineers at Apr-Automation in collaboration with me, the master’s student Pontus Wikholm.

The motivation for selecting Mitsubishi in comparison to other electronics suppliers like Bejjer, Simens or Omron was that Mitsubishi’s strengths are to provide stabile products and good support at a competitive pricing. They are not necessarily the top of the line, or the manufacturer with the most high end equipment but the other aspects were prioritized.

After the selection of subcontractor was made, a deal with Mitsubishi was made to buy a set of equipment to a reduced price. This set would exist of suitable components for the robot cell that was planned for the Elmina Automation exhibition. Below are two tables, table 5 lists the chosen components for the robot cell. Table 6 contains the software from Mitsubishi.

TABLE 5, THIS TABLE LISTS THE MITSUBISHI COMPONENTS USED IN THE PROJECT.

Component	Description
<b>PLC</b> – Q03UDVCPU	The PLC Q-series from Mitsubishi are built to be highly modular and flexible. There are several specialized CPU’s to meet different requirements and lot of different other modules to add on to the base unit to meet special requirements (Sandberg, 2013). PLC Q Series iQ CPU module;4096 EA;1.9 ns/log. Com.;30k steps;Ethernet;USB;SD
<b>HMI</b> - GT2712-STBD	HMI, graphic operation terminal, GOT2000-series, Mitsubishi electric.
<b>Base unit</b> – Q38DB	PLC Q Series Base unit iQ CPU, power supply, 8 I/O slots
<b>Power supply</b> – Q61P	PLC Q Series Power supply 100-240 V AC input, 5 V DC 6 A output
<b>Profinet IO Controller</b> - ME1PN1FW-CCPU	PLC Q Series;Profinet IO Controller
<b>Frequency converter</b> - FR-A840-00126-2-60	Inverter; Rated Power: 3,7kW; 3x380-500V; Rated Current: 9A; IP20
<b>Radio Noice Filter</b> - FFR-BS-00126-18A-SF100	Radio Noise Fiter for FR-A&F-00023-00126; C1 20m; C2 100m
<b>Profinet adapter to the frequency converter</b> - A8NPRT_2P	Profinet RT 2port Interface for FR-A/F800 with Drive Profile

The selected HMI is a model that has not yet been released on the market. It is agreed by both APR and Mitsubishi that it will be the most suitable series of HMIs in the Mitsubishi product assortment, to be include in the new APR standard. The chosen PLC is a high-speed, universal and flexible model that is suitable for many diverse projects and perfect as a standard choice for a company like APR Automation. The rest of the component selections are rather straight forward. Their purpose is to enable the connections and other properties that the system needs.

TABLE 6, THIS TABLE LISTS THE MAIN MITSUBISHI SOFTWARE USED IN THE PROJECT

Software	Description
<b>GOT Screen Design Tool</b> - GT Designer3 Version 1.108N	GT Designer3 is a complete HMI programming, screen creation, and maintenance program. In order to reduce the labor required to create detailed and impressive applications, the software's functionality has been built around the concepts of ease of use, simplification (without sacrificing functionality), and elegance (in design and screen graphics). (Mitsubishi Electric, 2013)
<b>PLC programming software</b> – GX Works2 Version 1.499V	GX Works2 represents the next generation in MELSOFT (see Terminology, page 1 for description of the acronym) PLC maintenance and programming software. Its functionality has been inherited from both GX and IEC Developer, with improvements made throughout to increase productivity and drive down engineering costs. (Mitsubishi Electric, 2013)

#### 4.1.4 DEVELOPMENT OF A USER INTERFACE

The development process in this project is based on Lars Ola’s development process for an HMI standard (Bligård, 2011). He states four general guidelines that should be fulfilled before starting the needs identification which is the first out of four parts in the development process. The four guidelines will be repeated below:

1. Presume that the task is the number one priority and that it should be performed efficiently, safely and so that other system components not are damaged.
2. Presume theory in manuals, standards and guidelines.
3. Presume empiricists such as studies of users, usage environment and usage situation.
4. Bring together and integrate empirical data and theory.

The first and second point were fulfilled by the company, but the third and even the fourth point was lacking. This was due to that the company has not carried out any empiric studies of users, usage environment or the usage situation.

#### *CASE STUDY OF A HMI IN PRODUCTION*

To fill a little bit of this gap, a case study of an APR machine running at one of their customer’s factories was completed early into the project. The case study consisted of two interviews. The first with an APR-programmer and the second was with an operator at the customer’s factory.

These interviews were unstructured interviews that proved to be highly rewarding for my understanding of these kind of systems. The case study also included an extensive going through and a workshop at the machine and it’s HMI by the responsible APR-programmer.

USAGE AND IMPLEMENTATION OF LARS OLA'S DESIGN METHOD

At the point where the four guidelines were considered to be sufficiently met the development process could start with its *needs identification*, followed up with the *function and task design*, *general design* and finally the *detailed design* step. These blocks are visually represented by the red circle in figure 8.

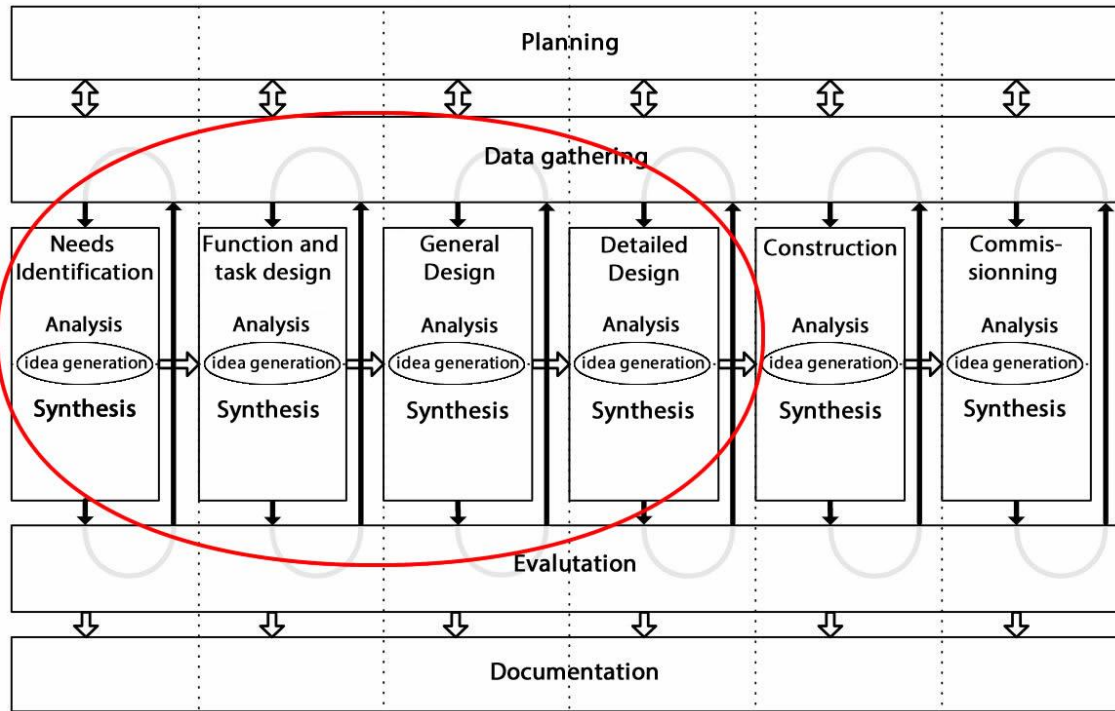

FIGURE 8, VISUAL ILLUSTRATION OF THE DEVELOPMENT PROCESS MODEL FROM THE DEVELOPMENT PROCESS FROM A HUMAN-MACHINE PERSPECTIVE. THE RED CIRCLE IS ADDED TO SHOW THE BLOCKS THAT ARE RELEVANT FOR HMI DESIGN.

The steps could not always be answered in a complete way since the task was to design a standard and a standard has to be general enough to fit diverse types of machines. The framework has been tested on the robot cell for the exhibition however where the task design and the system description was more detailed.

#### 4.1.5 ACTUAL SCREEN DESIGN

When the software and hardware for the Elmia Automation Exhibition project was delivered to APR, the components were temporary set up in an office. This since the robot cell for the exhibition was not yet built at that time. The main components that were set up was the PLC and the HMI. These components were also connected to each other and a computer via an Ethernet switch. The programming software was installed on the computer together with some additional programs from the Mitsubishi software company, MELSOFT (Namely the additional software's were a document converter, a HMI simulator and a PLC simulator).

The goal for the HMI standard is mainly for the programmers to have a framework to work with and clear guidelines for where to place buttons, lamps, menus, headers, specific information and so on. The conceptual model was made before the software was even accessed. Thus the model served as good guidance when starting designing in GT Designer3.

During both the design of the conceptual model and during the design of the actual standard program, focus has been on making the key functions and key information clearly visible and simple to access from any screen of the HMI. This has been prioritized much higher than designing an HMI with an impeccable appearance. In figure 9 below, the main screen of the APR standard HMI in GT Designer3 is displayed.

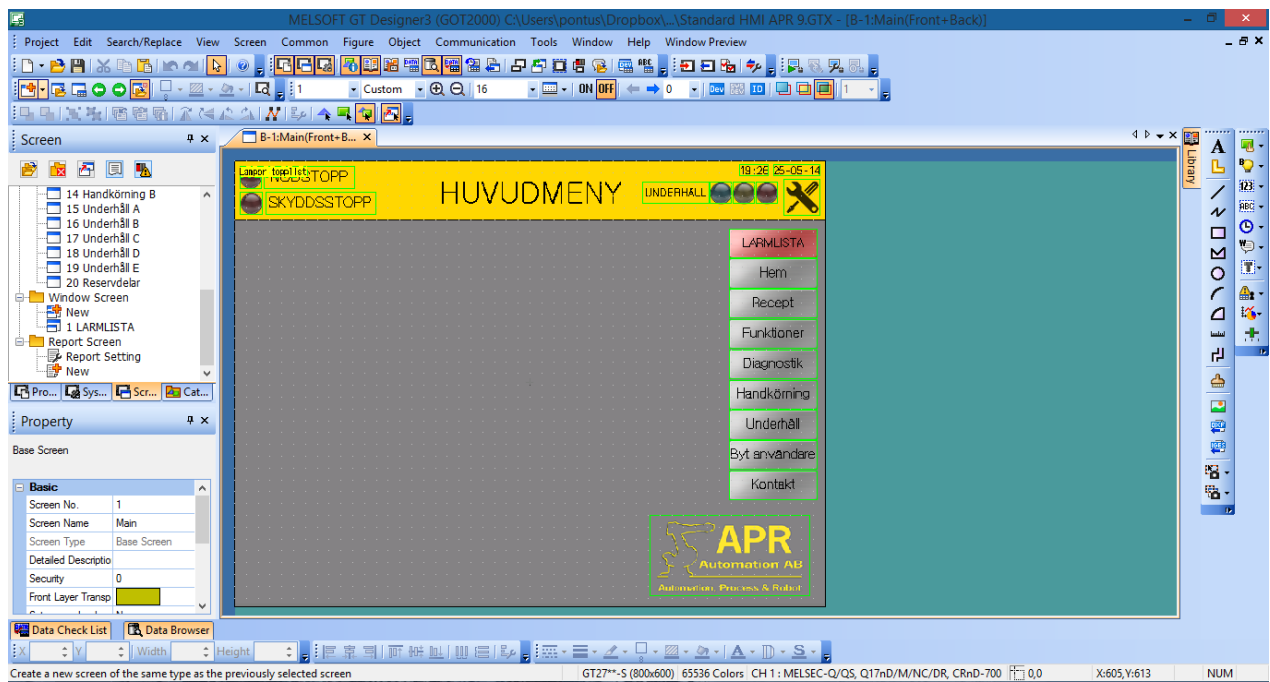

FIGURE 9, A PRINT SCREEN OF THE DESIGN TOOL GT DESIGNER3 AND THE MAIN MENU FOR THE APR HMI STANDARD.

#### 4.1.6 DETAILED DESIGN OF APR STANDARD HMI

The general layout for the HMI standard builds on the conceptual model with a top frame where important information is displayed, (the yellow area in figure 10 below) and the menu buttons, on the right side of the screen.

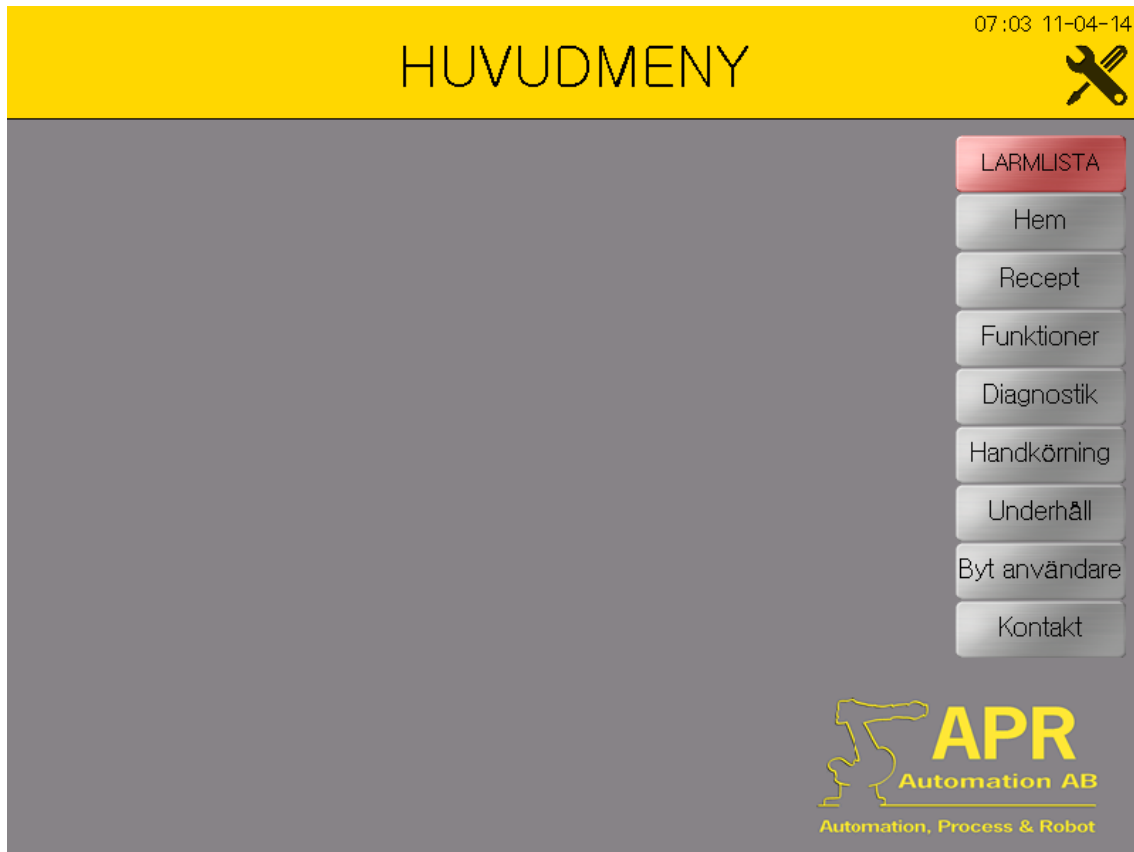

FIGURE 10, A PRINT SCREEN FROM THE SIMULATION SOFTWARE, GT SIMULATOR3, OF THE MAIN MENU FOR THE APR HMI STANDARD.

#### *MENU*

The menu buttons, on the right side in the figure above, are accessible directly from any page on the HMI and they are always placed in the same position to promote fast learning, for new users. This will also create a sense of consistency and trustfulness towards the interface. (Bohgard, 2011)

#### *WORKING SPACE*

The dark gray, empty area in the middle of the screen is meant to be utilized for the functions of each page. It is recommended to place the most frequently used functions and most important information on the main page for that information to get the operators highest attention. The buttons and information that is placed here will change together with the title on the top of each screen, when the user presses any of the different menu buttons.

## MENU FUNCTION

As it is shown in the graphical representation of the conceptual model, three of the menu buttons contain underlying menu selections. The strategy in these cases, was to show a quick view of the most important underlying screen when one of the main menu buttons were selected. At the same time a new popup menu would appear to the left of the selected main button with the underlying menus. In figure 11 below it can be see that “Diagnostik” (diagnostics) is selected in the main menu.

As a consequence the top title has changed to Diagnostik. But the screen shows the same content as of the underlying menu selection called “Säkerhet” (safety). This might seem a little bit confusing but the reasoning for designing the function in this way, is that the user will not stay for long on the screen selection of “Diagnostik”. He/she will swiftly make a selection of which underlying menu that he/she want to access. When he/she makes that selection the popup menu will disappear and the selected menu button will get the whole available space for its functions and information. The title will also change to whichever screen the user selects. The better and more intuitive way would have been to stay at the current screen until a selection in the underlying menu was completed. This was unfortunately not possible in GT Designer3. The reason for this is further discussed and explained in 6.1.2 *The software GT Designer3* under *Menu problems*.

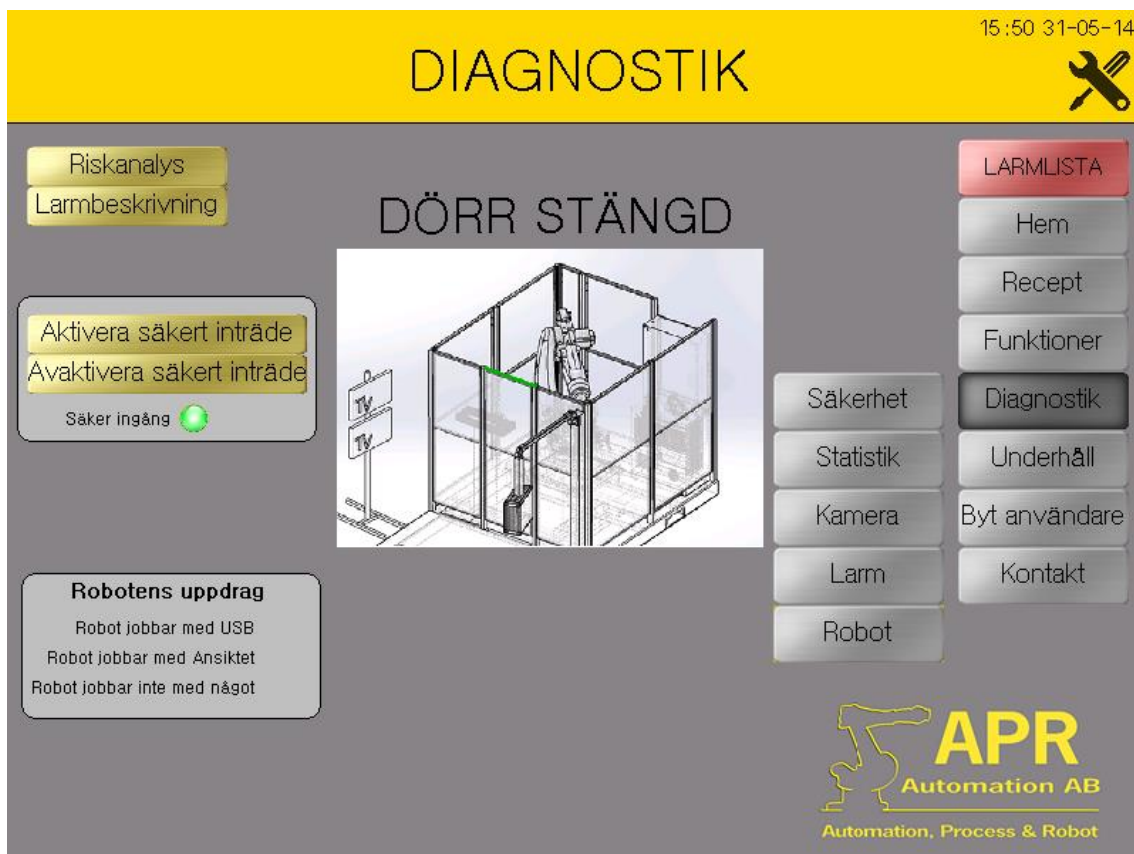

FIGURE 11, A PRINT SCREEN OF THE UNDERLYING MENU, “DIAGNOSTIK” WHERE A QUICK VIEW.

## TOP RIBBON

Figure 12 displayed hereinafter shows the top frame of the HMI standard. This region is of high importance since this frame will remain the same when the user navigates in and out of different menus. The only exception is that the title in the center of this area changes between different menus. Thus this area is suitable for holding important warning lamps. And information that needs to be clearly visible at all times. To the left on the ribbon there are two lamps “Nödstopp” (emergency stop) and “Skyddsstopp” (protection stop). This is important information that the operator needs to get alarmed about as soon as possible. On the APR machine for the Elmia exhibition a light tower is used in addition to the lamps on the HMI to ensure that the operator notice a protection stop or an emergency stop. More information on the type of information that is put in this area can be found under 4.1.6 Maintenance.



FIGURE 12, TOP RIBBON

## ALARM HANDLING

One of the most important functions for the HMI is to alert and inform the operator when something has gone wrong with the system. This function is called alarm handling in automation industry. In APRs HMI standard this is done by the usage of a temporary ribbon at the bottom of all screens. This black ribbon has an alarm text slowly scrolling sideways. The text will keep on sliding across the bottom of the screen over and over again until the operator has corrected the alarm and restored the alarm in the alarm list. Figure 13 shows the rolling alarm text.



FIGURE 13, ALARM TEXT SLOWLY ROLLING SIDEWAYS

### 4.1.7 FUNCTIONS

A few specific functions were desired by Apr. The first and most important one was a function that managed the preventive maintenance of the machine. After that a few design functions will be discussed and finally in this chapter some special functions will be brought up.

## MAINTANANCE

Manufacturing companies are getting more and more aware of the importance of maintenance. Chan writes:

*“Maintenance costs account for 15–30% of today’s manufacturing costs and up to 33% of maintenance cost is wasted.” (Chan, et al., 2003)*

He also concludes that:

*“Emergency repairs are often three times more expensive than the same job done preplanned” (Chan, et al., 2003)*

Both the company APR and their customers are starting to understand that doing maintenance in the right way can save a lot of production downtime, employee overtime and hence also

money. Providing this functionality to their customers is also an important competitive factor for APR. The function is designed to mimic the warning lamps of a car. A warning lamp will be lit on the HMI if something is not working the way it should, or if the timing for a specific type of maintenance has come. The operator can then choose to keep running the machine best he can or do something about the problem.

The function was built with three levels of maintenance. The levels are listed below:

1. Operator maintenance
2. Maintenance personnel maintenance
3. APR maintenance

These levels are represented by three lamps on the right side of the top ribbon. In figure 14 below the yellow, middle light is lit while the other two is dark. The blue lamp to the left indicates that an operator maintenance needs to be made. The yellow in the middle indicates that the maintenance personnel needs to do maintenance on the machine. And finally, the red lamp stands for that, depending on the problem an APR programmer or an Apr mechanic needs to come and perform maintenance.

These lamps were also designed to call for extra attention by blinking. The blinking frequency increases with the seriousness of the maintenance alarm. The operator maintenance blinks with the lowest frequency and the APR maintenance blinks with the highest.



FIGURE 14, MAINTENANCE LAMPS IN THE TOP RIBBON

If the operator would detect that a maintenance lamp is blinking he/she could either enter the maintenance screen by navigating there in the main menu, or he/she could press the maintenance lamps in the top ribbon and he/she will end up at the maintenance screen.

In figure 15 below the maintenance screen is shown when an operator alarm is active. In the example below no PLC is connected to the HMI so it doesn't show any real data in the column "Tid/Operationer kvar" (Time/Operations left). But when the HMI is used together with all other equipment a PLC program will keep track of the number of operations left before a maintenance is required. In the same way a PLC program will count and compare the stroke times of the pneumatic cylinders and indicate when they need lubrication.



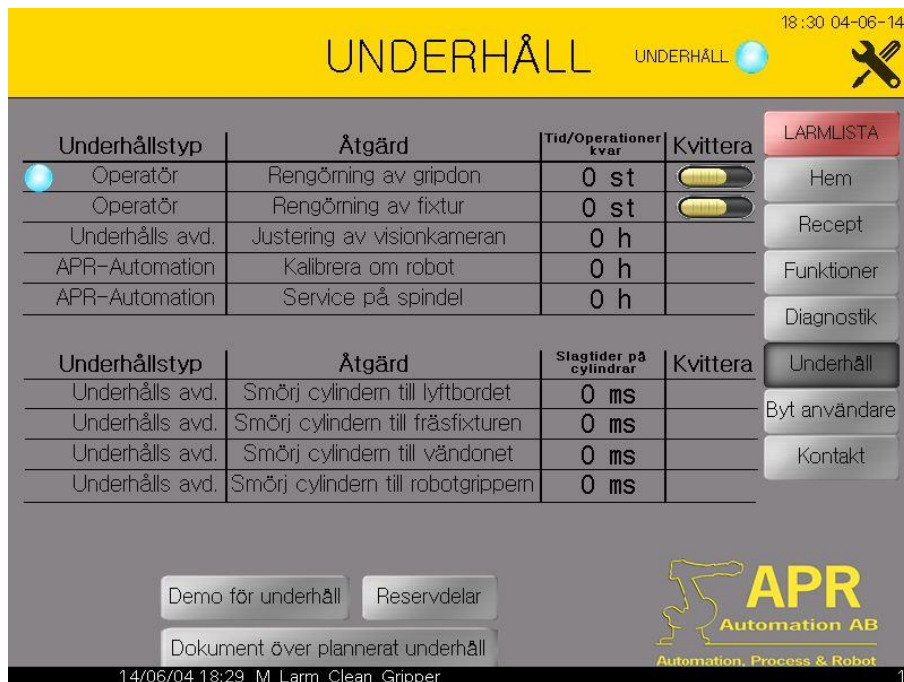

FIGURE 15, MAINTENANCE SCREEN WITH AN OPERATOR ALARM ACTIVE.

In figure 15 above, two golden buttons can be seen on the right side of the table. These are switches to confirm that maintenance has been carried out and they will reset the alarm signal. If a maintenance alarm is triggered that has to be conducted by APR staff or maintenance personnel, an operator will not have access to confirm this type of maintenance. This is why the two top tasks are the only ones where confirmation buttons can be seen in the figure above. An APR programmer can change user on the HMI to a user with the security level of an APR employee. If that is done, confirmation switches for all the tasks on the maintenance screen will become visible and the programmer will have access to them.

### DESIGN FUNCTIONS

As previously mentioned the functionality has been in focus throughout the thesis. Although the visual quality of the interface has been seen to whenever an opportunity or an idea has come to mind. One visual function that is used is Invisible buttons that are used to make the HMI more intuitive. For example an invisible button is placed over the logotype down to the right, so that if a user press the logotype he/she will be navigated to the contact screen.

The property of making objects invisible has also been a part of the concept for the warning lamps in the top ribbon. When a lamp is inactive it will be invisible until a maintenance alarm, emergency stop or a protection stop occurs. This mechanic highlights the active alarms since the inactive ones are not visible at all, until they become relevant.

Another design aspect that has been considered is the usage of symbols. Below figure 16 shows the button for the HMI settings screen.



FIGURE 16, THIS FIGURE DISPLAYS THE SYMBOL USED FOR THE HMI SETTINGS.

A different example of visual information is that solid works (3d-CAD software) drawings have been used to visualize if the door is open or closed (see figure 17).

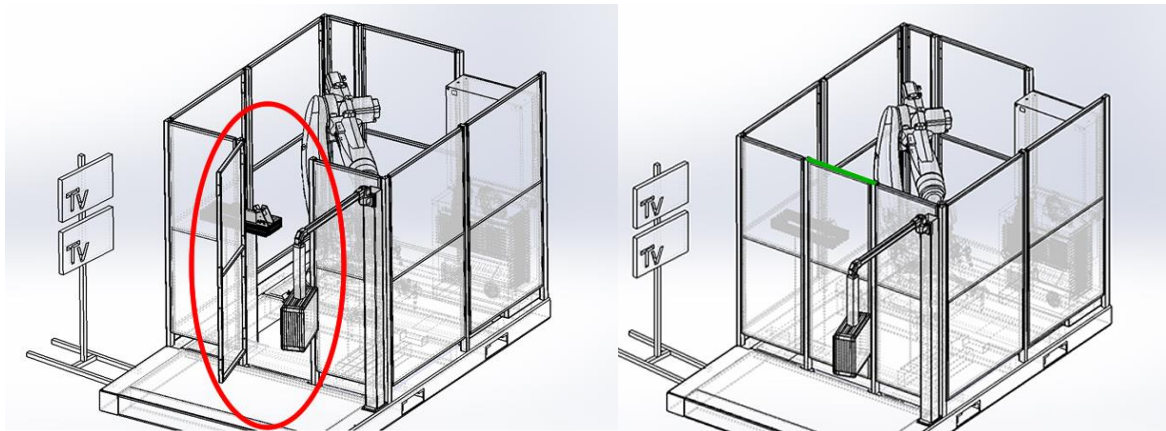

FIGURE 17, THIS FIGURE DISPLAYS THE PICTURES THAT WERE USED ON THE SAFETY SCREEN OF THE HMI TO THE ELMIA EXHIBITION.

### *SPECIAL FUNCTIONS*

Some special functions are tested in the HMI standard. One of them that did not work so well was the usage of a surveillance camera. A multimedia extension to the HMI was used in order to plug the camera in to the HMI with a BNC cable. This device was delivered very late into the project. More particularly three days before the transport to Jönköping. When the camera was plugged in to the HMI the image that was displayed on the screen was terrible. The funny part was that if the recording function, in the HMI was used the picture was perfect but no live feedback of the video image could be seen on the screen while recording.

It was assumed that the camera was the problem so a new camera was ordered. However the new camera showed the same bad and dark image. Mitsubishi Electronics support sent a set of different solution proposals involving the program, the multimedia unit hardware and the camera. This was two days before the exhibition was due to start. To summarize this there was no time to work more with the camera but since the hardware was there it is likely that some trial and error would solve the problem. Unless there was some kind of deeper issue with the camera or the HMI.

An example of a special function that did work, is the functionality of using the HMI as a virtual network computing server (VNC server). This function enables other devices to connect to the HMI over the Ethernet network and display the HMI screen on this other device. This function works on PCs, phones and tablets and it was a suitable function to demonstrate on the Elmia Automation exhibition.

Other functions that were successfully set up were a backup function, a recipe function, statistics for a frequency converter, management of multiple users and display of several different types of documents. Some scripting was also done in the software. The scripting feature was simple to use and had a good help menu to find suitable commands.

## 4.2 ELMIA AUTOMATION EXHIBITION 2014

This chapter will briefly describe the planning, construction and programming of the APR machine that was build tor the Elmia Automation Exhibition 2014. The Elmia project has been carried through by me, Pontus Wikholm together with another student from the mechatronic program at Karlstad University, Per Ehrencrona. We were together given the responsibility for this project all the way from discussions about what the machine should do, through ordering components and building the framework to finalizing the PLC and the robot programs. We have of course gotten a huge amount of support and help from APR for this to be possible with the limited knowledge off building automation systems that we both had at the start of the project.

### 4.2.1 PROJECT INITIATION

It was decided in consultation with several key persons at APR that the exhibition machine would demonstrate two main techniques. The first one is called KUKA Safe Operations and the second is called KUKA CNC. The task that was chosen for the APR machine was to mill/carve APR's logotype plus the exhibition visitors name in a USB stick in bamboo. The exhibition visitors name would be typed in at the HMI, by the visitor him or herself. The machine would also copy an APR presentation to the USB stick by letting the robot connect the USB stick to the HMI panel where the presentation was stored. After the processing and file copy process the robot should have delivered the product directly to the exhibition visitors hand through an open hatch. He/she would keep the USB stick as a present form APR automation. This planned process was modified slightly due to issues with the systems software. More information about the final process can be read about in the result and evaluation chapter 5.

#### *KUKA SAFE OPERATIONS*

KUKA Safe Operations would demonstrate that APR have the knowledge and skill to make a robot cell less hazardous then it normally would be. This with the use a safety software from the robot manufacturer KUKA. The usage of this software can change the way that an operator can work together with the robot without violating any safety regulations. This is possible because the robot itself has the hardware to be considered safe enough. Its sensors will accurately display the positioning of the different robot axes and the robot itself cannot scamper away to a random position. The risk is normally in the robot program. The programmer can easily make a mistake or a bug in the program that no one sees until an accident occurs (KUKA, 2013).

The Safe Operation software does two main things. First of all it forces the programmer to work with different robot zones and can thereby allow operators to work close to the robot as long as the robot only is permitted to work in certain zones while the operator is nearby.

The second property that the software Safe Operation grants the robot is dual channel safety. This is a requirement from the Swedish standards institute in order to put the compliance with EU legislation-tag (CE-tag) on the machine. This CE-mark guaranty that the machine is safe and has been given a proper risk analysis (European Commission, 2006).

Dual channel safety basically means that if one safety circuit would malfunction or get broken, there would be a backup circuit to make sure that the safety system still was functioning as intended. This turned out to be a problem in this thesis project. A misunderstanding occurred between APR and KUKA which led to that the components required for the dual channel communication to work, were not ordered in time. This misunderstanding will be further described and discussed under *6.2.3 KUKA Safe Operations*.

## KUKA CNC

This technique is similarly to KUKA Safe Operations, a software supplement for the robot. This software is highly interesting for the processing industry, since it gives the robot the ability to run on G code (this type of code is most commonly used in CNC machines). APR has previous to this project performed tests that show the difference in precision of processing with normal KUKA robot code (KRL code, figure 18 below) and with KUKA CNC (G code, figure 19 below). The results from previous tests are displayed in the figures below. (These tests were not performed by the thesis project. Their purpose in this text is to show the reader that a more precise machining can be acquired by this kind of software usages.)

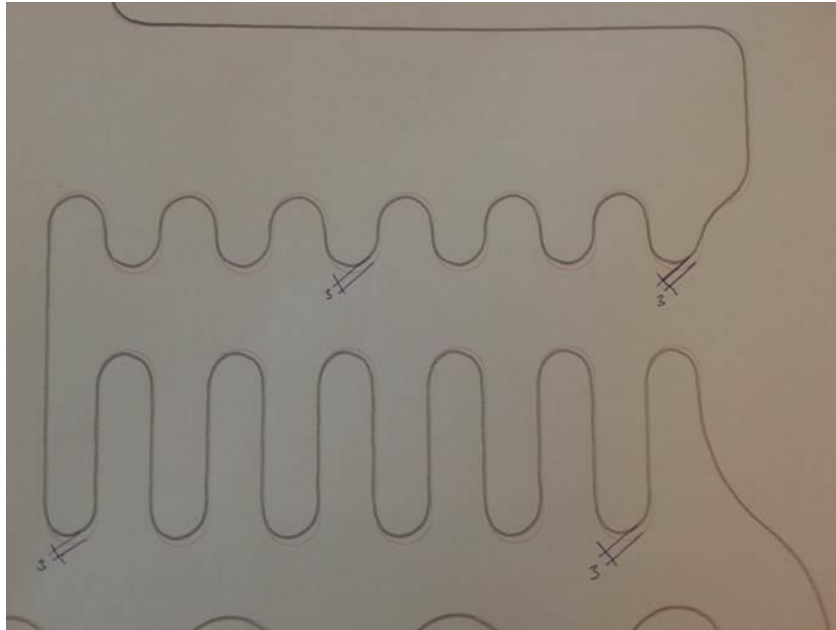

FIGURE 18, THIS FIGURE DISPLAYS A TEST WHERE A ROBOT IS PROGRAMMED TO FOLLOW A PATTERN BY USING KRL CODE.

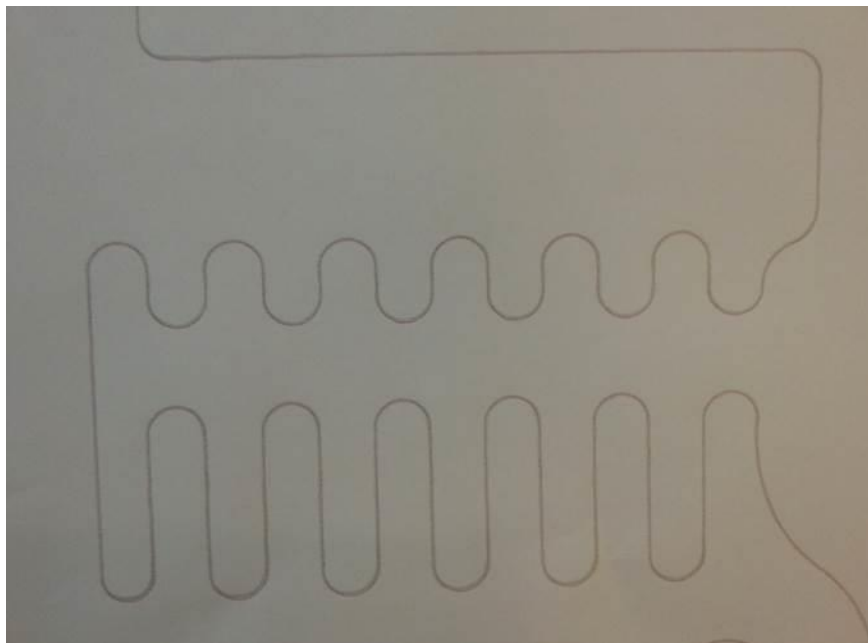

FIGURE 19, THIS FIGURE DISPLAYS A TEST WHERE A ROBOT IS PROGRAMMED TO FOLLOW A PATTERN BY USING KUKA CNC AND G CODE.

As the two figures above shows the deviation between the desired pattern and the pattern that the robot has actually taken cannot be seen with the naked eye on the second picture. While in the first test with the normal robot code the deviation is clearly noticeable.

The choice of including this software in the APR machine for the Elmia exhibition, was mainly made because the exhibition cell was going to mill wooden material. Furthermore the machine was going to process small products so high precision was important. Unfortunately the usage of this software also encountered problems during the preparations for the exhibition. The issue was that the robot that was brought to the exhibition, only had run KUKA CNC in manual mode previously. When KUKA CNC was attempted to be used in the robots auto mode it bugged and did not work as intended. The KUKA support was contacted but were not able to solve the problem in time for the exhibition. This issue will also be discussed further in *6.2.1 KUKA CNC*.

### *COMMUNICATION PROTOCOL*

The communication protocol that was planned to be used in the Elmia Exhibition Machine between PLC, Robot and the I/O-module was PROFINET. APR has previously mainly used PROFIBUS but, as previously mentioned in *2.2.2 Communication between the components*, the PROFINET protocol enables simpler wiring and it is a newer and more flexible communication protocol.

This planned solution also encountered problems along the way. When the wiring was under way in the machine, the APR programmers discovered that the robot could not communicate via PROFINET. On paper the robot was perfectly capable of communicating via PROFINET, but the reason for that it couldn't was that the operating system in the robot was outdated. A simple upgrade of the software could not be made without upgrading a few hardware components in the robots cabinet as well. Instead PROFIBUS communication was used and some new components had to be ordered in the last minute. This problem and the cause of it will be further discussed in the discussion chapter *6.2.2 Communication protocol issue*.

### *RISK ASSESSMENT*

A risk assessment was made to analyze the safety of the machine and make sure that it would be approved by the Swedish machinery directive. The method and software that was used for this purpose was called CEDOC (see Terminology, page 1 for description of the acronym). This program provides a thorough investigation that helps the user to identify every potential injury risk that the machine expose the operator or other personnel to.

#### 4.2.2 ROBOT CELL KONSTRUKTION

The mechanical construction was made in Solid Works. This is the software that APR Automation use for constructing all their systems in 3d. The components placements and the robots range was also analyzed in Solid Works before anything was built. Figure 20 below displays the 3d drawing of the APR machine for the Elmia Automation exhibition.

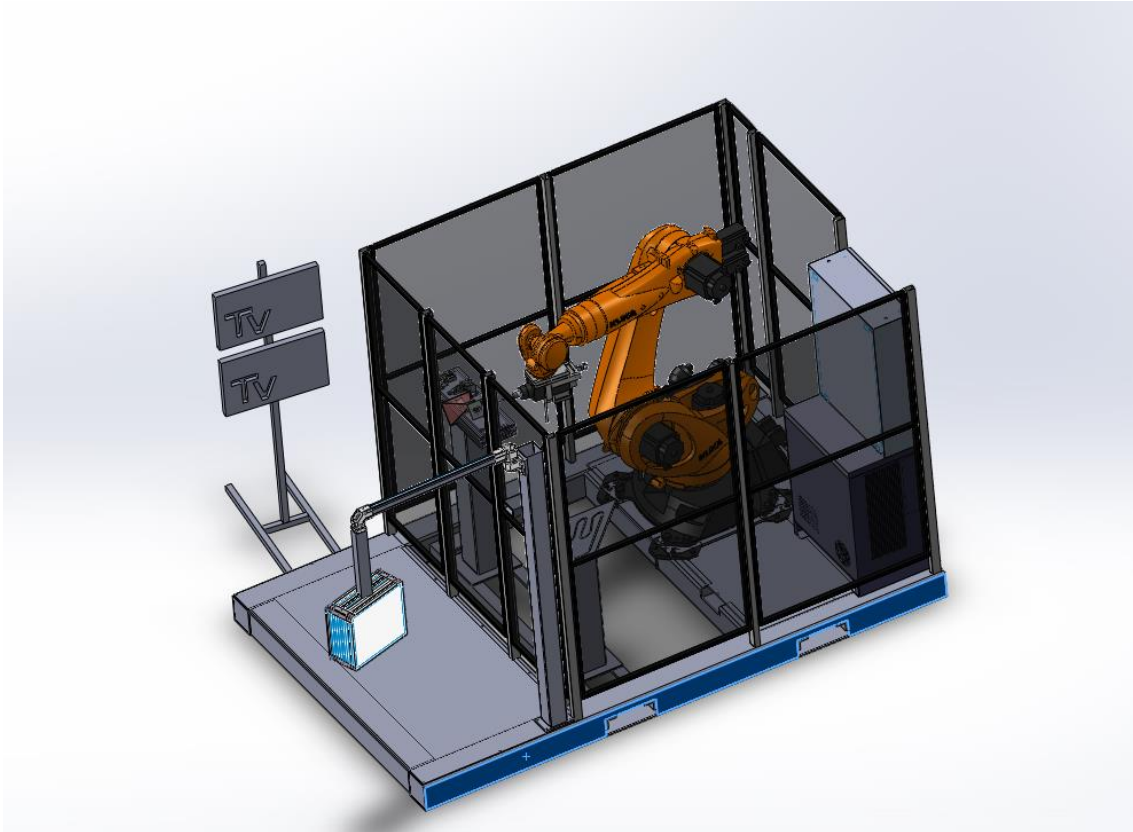

FIGURE 19, THIS FIGURE DISPLAYS THE APR MACHINE FOR THE ELMIA EXHIBITION AS IT WAS DRAWN IN SOLID WORKS BEFORE IT WAS BUILT.

The manufacturing of the steel frame and was mainly done by a welder on site at APR. All the brackets for sensors, brackets for the pneumatic tools and the tool tables were made by blue color workers at APR automation. Most of the painting was outsourced to a subcontractor to APR but some details were painted locally. The assembly of all components was done at APR by the students together with APR staff. Figure 21 and 22 shows how the robot cell is taking form.

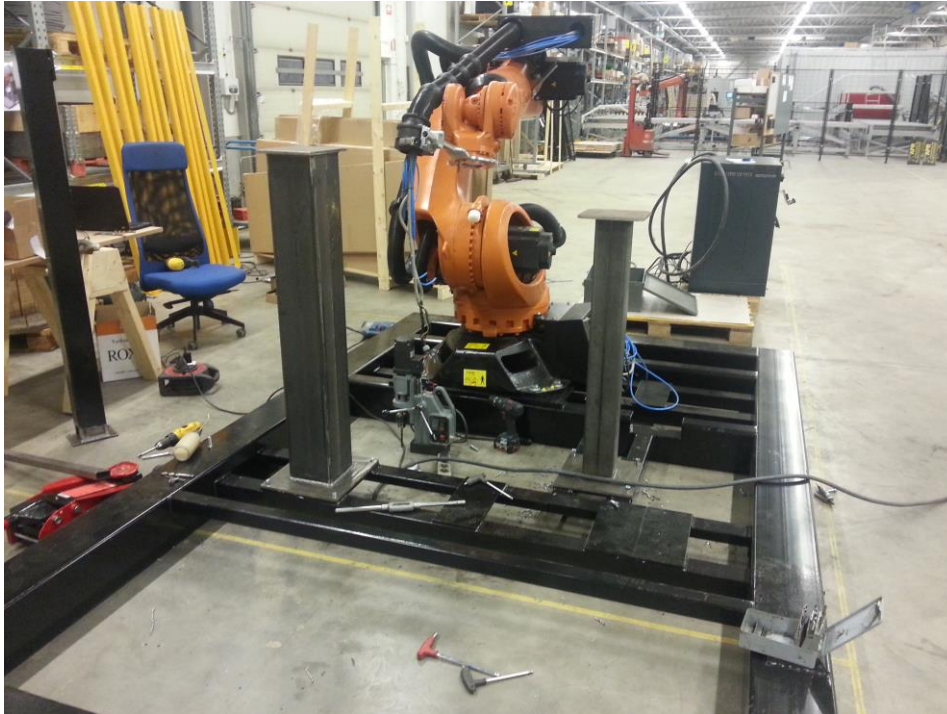

FIGURE 20, THIS FIGURE DISPLAYS THE APR MACHINE FOR THE ELMIA EXHIBITION IN AN EARLY STAGE. THE ROBOT HAS RECENTLY BEEN FASTNED.

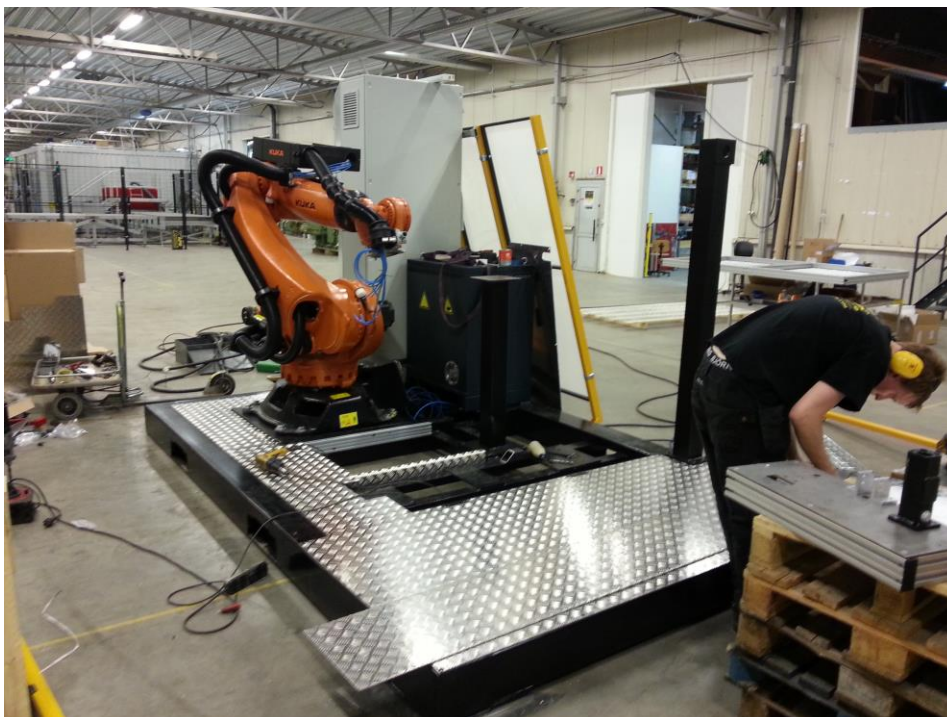

FIGURE 21, THIS FIGURE DISPLAYS THE APR MACHINE FOR THE ELMIA EXHIBITION. HOLES ARE BEING DRILLED FOR THE FLOOR AND THE SAFETY FENCE IS BEING SET UP.

### 4.2.3 PROGRAMMING

The programming of the PLC, Vision camera and robot was basically done in three steps. First of all the task was written down in text to make sure that all the steps in the logic was thought through. The next step in the workflow was to make a graphical function description. In the third and final step this could be transformed to PLC code and KRL code. Figure 23 below shows a small clip from the function description.

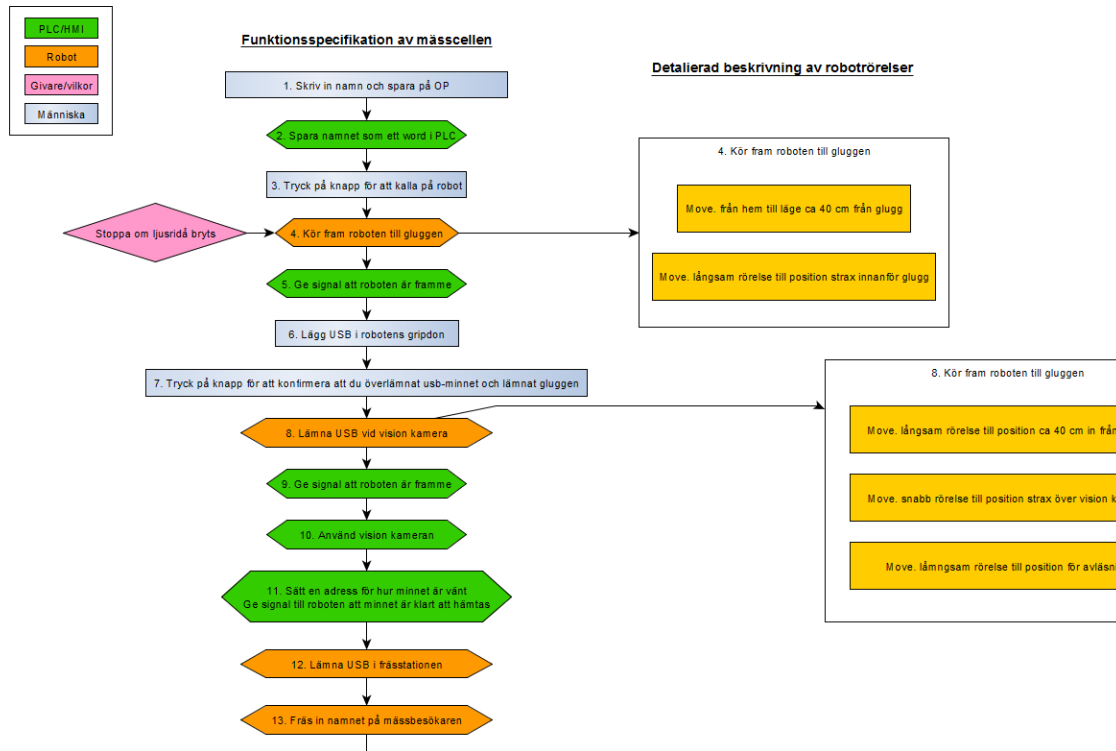

FIGURE 22, A SMALL PORTION OF THE FUNCTIONAL DESCRIPTION.

The programming responsibilities was divided so that Pontus Wikholm, was responsible for the PLC code while my student colleague Per Ehrencrona took responsibility for the robot programming. This distribution made most sense, since I was responsible for the HMI program and that is tightly connected to the PLC. Figure 24 shows an extract from the PLC program.

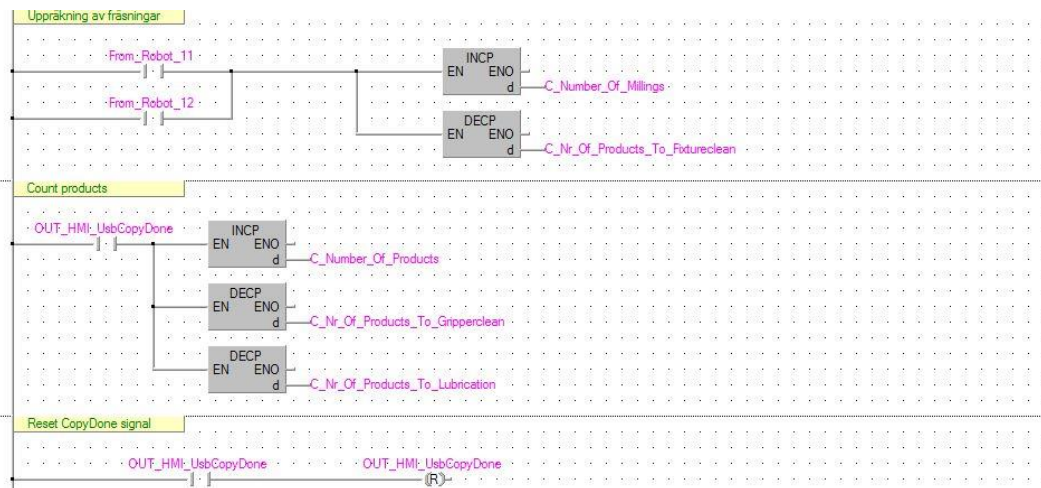

FIGURE 23, AN EXTRACT FROM THE PLC PROGRAM HANDLING MAINTENANCE.



## 5 RESULT AND EVALUATION

---

### CHAPTER INTRODUCTION

*This chapter will shortly describe the thesis project's results and evaluate them. The primary objective was the HMI and the secondary objective was the APR machine for the Elmia Exhibition.*

---

#### 5.1 HMI STANDARD

The primary objective of this master's thesis project, is to develop a concept of a standard HMI program. This was a mix between practical work in the form of design and programming and theoretical work with creating a conceptual model and implementing suitable design methods and conventions.

The result from this working process is in the end a file with the title "HMI Standard for APR Version 1". Besides this the company gets a documentation of the HMI standard with a list of hardware, software and a few words of advice on how to work with the software. APR also get the Master's Thesis report serving as a coverage of the project and a discussion that hopefully can prevent a few future missteps.

The timeframe for the thesis has not made it possible to evaluate the HMI on any deeper plane. All key persons at the company, in regard of the HMI, have also been extremely busy in other projects during the final weeks of the thesis project. A deeper evaluation would have been preferred before the development project was rounded off. But out of the little that these key persons nevertheless has seen of the new HMI standard they seem fairly satisfied. Also the standard has been tested on the machine for the Elmia Automation Exhibition with good results. Due to the lack of evaluation and testing, the deliveries from this thesis project should not be seen as a final product but merely a starting point to further development.

#### 5.2 ELMIA AUTOMATION EXHIBITION 2014

The second objective was to develop, build and program a robot cell for the Elmia Automation Exhibition in Jönköping. At the exhibition the HMI standard was displayed and evaluated by the exhibition visitors. The result of this part of the project was that the Elmia Automation exhibition was satisfactory for APR automation. The machine fulfilled its purpose to serve as a test platform for the new APR standard. As well as to demonstrate the width and competence of the company APR Automation.

The machines function did not end up exactly as it was planned from the start. The KUKA Safe Operation software could not be used so the product was delivered to and from the robot by an in- and output sliding track instead of any direct contact with the exhibition visitor as it was originally planned. The KUKA CNC software could not be used when machining the USB sticks but the result turned out okay with the usage of normal KRC code instead.

There was one drawback from that this function malfunctioned. The whole name of the exhibition visitor could not be milled/carved into the USB stick. His or her initials had to be good enough. Judging by the visitors' reactions many of them were impressed of just that any way since they got to input their own initials on the HMI. Seconds later they could see the same letters be machined by the robot and spindle on a real product in the robot cell. Figure 25 below shows the APR machine onsite at the automation exhibition.



FIGURE 24, THE APR MACHINE AND PER EHRENCRONA AT THE ELMIA AUTOMATION EXHIBITION IN RUNNING MODE.

### *THE PRODUCT*

Unlike many other production systems the main purpose of this APR machine was not directly to produce perfect products. In this case the machine's purpose was rather to use the exhibition machine as a test platform for their new standard. As well as to demonstrate the width and competence of the company APR Automation.

Still the product turned out okay. One side of a completed USB stick is displayed in figure 26 below. The thought with the system was to process something that the visitor would actually use after the fair. The choice of product was shown to be even more popular than expected. People did not come only for the giveaway however. There was a strong interest in the process, equipment, programming and the company.



FIGURE 26, ONE SIDE OF A PROCESSED USB STICK WITH THE INITIALS OF HENRIK KHILMAN

## OVERALL RESPONSE

The overall response from the fair visitors was good. The robot cell acted as an eye catcher and many times it lead to more questions about APR and in some cases potential leads to future projects. There was no major problems with the equipment during the event. Only a few smaller issues that were solved on the spot. Figure 26 below shows a group of visitors in front of the machine.



FIGURE 25, THE PICTURE SHOWS A GROUP OF YOUNGER VISITORS WHO SHOWD GREAT INTEREST IN THE SYSTEM.

## RESPONSE REGARDING THE HMI INTERFACE



The HMI naturally became a center point of discussion since this was where the production cycle was started every time a new visitor came and wanted to see the machine. Although not as many deep discussions and HMI demonstrations took place. My impression was that most visitors only had basic knowledge in automation systems and could therefore not comment more than briefly on the design or the functionality. Figure 27 to the left shows the HMI in usage.

FIGURE 26, THE HMI PANEL MOUNTED ON THE ARMATURE

### CHAPTER INTRODUCTION

*This is an important chapter where the project results, the used method, the practical work and the company APR is discussed out of a Master's student of production engineering's perspective.*

---

### 6.1 HMI

#### 6.1.1 COMPONENT SELECTION

As previously mentioned there was reasons for choosing Mitsubishi as the main supplier of electric components like HMI, PLC and frequency converters. The main reasons were that Mitsubishi could provide stabile products, fair pricing and good support. Their support is good thanks to that Mitsubishi Electric recently opened their own Nordic sales office in Sweden. Previously Mitsubishi products were sold by Beijer Electronics in Scandinavia. At that time the support on the Mitsubishi brand was less convenient then it is now. There are however negative sides of this selection that became clear when working with the hardware and software. Most of the criticisms raised here will regard the software GT Designer3 for programming the HMI.

#### 6.1.2 THE SOFTWARE GT DESIGNER3

The most apparent negative property of the software is that the user gets a feeling of working with an old and obsolete software when working with it. It is lacking well working snipping and sizing functions when working with buttons, lamps and figures. Also some central functions are under desperate need of development. For example, there are very lacking functions for how to create menus. As described in *Menu function* under 4.1.6 the most intuitive way of creating a menu with several levels was not possible with the general functions of the software.

#### MENU PROBLEMS

The selected solution for the menu functionality, was to show a quick view of one of the underlying menus until a final selection of underlying menu was completed. A different solution would have been to create an empty screen with the title of the upper menu selection and show that until the final selection of underlying menu had been made. This solution would have created a more clean appearance and it would maybe be less confusing. The downside of that solution would have been that the users would have got a feeling of that he/she was using an uncompleted HMI program and that something was going to get added there at a later stage.

A third solution to this specific problem was attempted by using special functions in the software. This solution would have been the most preferable one, because it would have let the user stay on the page he/she currently was viewing until a final selection was made. The issue however with implementing this solution was restrictions in GT Designer3's popup menu functionality. The software proved to be lacking in its functionality in this case and its limitations made it feel old and undeveloped.

## *SCRIPTING*

There is a well-functioning script function in GT Designer3 as previously mentioned in *Special Functions* under 4.1.7. The problem with it in this project has not been the scripting feature itself. The problem has been that scripts have been needed to compensate for lacking functionality in the program.

When scripting was used to create an advanced behavior or handle device communication it felt suitable to use it. It was simple to use but in the same time the scripting language contained sufficient commands to perform most tasks. An attempt was made to use scripting to solve the menu problem that is discussed above. This felt wrong from the start since we were attempting to rebuild main functions in the software. It didn't work out like planned so the idea was abandoned.

## *FONTS AND COLORS*

The appearance has as previously mentioned not been given the main attention in this project. However it is impossible to avoid reflecting over that there are clear restrictions in GT Designer3 for both colors and fonts. It is for example not possible to change the colors of a lamp or button via a RGB slide or via a color pallet. There are only 13 colors and only not all of them can be used for all buttons and lamps in the program. The range of fonts that are available is wider but there are not features for importing new fonts. When using certain features like for example creating an alarm list there are only 3 fonts available to choose from.

I think that these flaws are terrible to find in a software in the year of 2014 that is frequently updated and that belongs to a company who sells it worldwide. Something else that is worth commenting on is that some fonts in the font selection list does not support the Swedish letters "ÅÄÖ". If it is attempted to use a font that does not support any of these characters the software won't alert the programmer about it. The only way to detect the problem is to carefully study the text in different buttons with the same font. If one button has Å, Ä or Ö included in its text the font will automatically be changed by the software and a difference can be seen between the fonts in the buttons. It took some time to figure out why some buttons got a different font then others when the same font was selected.

## *POSITIVE ASPECTS AND FUTURE THOUGHTS ABOUT THE SOFTWARE*

It is easy to focus on all the bad things in a discussion. The truth is that GT Designer have some positive things that also are worth mentioning. The main thing that has been brought up swiftly is that the software is very stable. I don't think that it has crashed once during the whole 20 week project. It is also not to resource demanding and its tab and window functions work really well. It also has functions for creating new buttons and lamps from images which can be very useful. I don't have any complaints over the recipe, alarm, language or VNC function either they all worked well.

It is obvious that Mitsubishi Electric is trying to catch on to the development train and stay competitive with their competitors. For example they have recently introduced swiping, panning and pinching functions in their newest HMI models. This is included in the model that was worked with in this project. However it is clear that the hardware in the HMIs are not developed for this type of control. The screen lags and loses connection with the fingers all the time when these functions are used. Another function that Mitsubishi is rather new on is the possibility to upload documents and view them on the screen. This function is a little troublesome since the documents have to be converted to the JPEG format before they can be

read by the HMI. This is done by using a document converter but the quality becomes impaired compared to the original files and editing is totally out of reach when this method is chosen.

Despite the problems discussed I think that Mitsubishi can survive and remain a big supplier in the future. I think they mainly need to focus on their strengths of stability and competitive pricing. In addition they should invest in development of the software. MELSOFT could do great improvements with relatively small resources regarding the functionality and appearance of the software.

### **6.1.3 DEVELOPMENT PROCEDURE AND METHOD**

The development procedure was based to a large extent, on the APR mentality which very much is to figure everything out along the way. This mentality was mixed up with the desire and need to find and follow existing methods and previous research within the area of Human Machine Interfaces.

The main method that was used in the thesis was Lars-Ola Bligårds method from his book; *The development process from a human-machine perspective*. In his book he has a chapter that is focused on developing a user interface. This whole chapter has been of great use in this project. The only problem with implementing his method fully was that he describes a normal development process. In this special case it is not a definitive product that is being developed it is a general standard. Some of the parts of his method was therefore not suitable for this project. The other theoretical source that was used very much during the development process was the 13 guidelines from the book; *Work and technology on the operator's conditions*. These guidelines were simpler to take into account than the more sturdy methodology from Lars-Ola Bligård.

### **6.1.1 HMI STANDARD FOR APR VERSION 1**

The title of this chapter is also the title of the concrete result from this Master's Thesis project. My personal opinion of the standard program is that it is in need of further development and not least evaluation, by competent and experienced HMI programmers before it can be used straight off the shelf in new projects. It is surely a good start on a future standard and most importantly a well needed pointing in the right direction for APR Automation. The company needs to structure up the way they work and I would like to quote Taiichi Ohno once more.

“ *Without a standard there can be no improvement – no development, no evolution of the organization and its systems.* ”

I don't necessarily think that this is true in all organizations and situations but I do think that standardizing can be used as a powerful tool if it is used in the correct way. The result from this project should be built upon and my hope is that there in the future will be deeply rooted standard ways of working in APR in several areas of the organization.

## **6.2 ELMIA AUTOMATION PROJECT**

The nature of the actual task that the machine would carry out during the exhibition didn't really matter so much to APR Automation. It was more important how APR was highlighted and what kind of conversations and discussions APR's exhibition contribution promoted. The true value of attending a large and expensive exhibition like this one for an integrator like APR can be discussed. The most part of the exhibitors were big product manufacturing brands like ABB, KUKA, MOTOMAN, FESTO, SCHUNK and many more similar companies. All of these have a big and important brands to promote and defend towards their competitors. It is of course important for APR as a brand to be seen in these events once in a while but the truth is that there are very few potential customers to the company at such events.

In this case it was still motivated for APR to attend the fair. Partly to get a platform to test and develop the APR standard on. Partly also to satisfy some subcontractors that wanted APR to use their products on the fair and thus promote both APR and the subcontractor. On the other hand to visit such events as a materials purchaser at APR should be valuable. An exhibition is a perfect place to get updated on new technology and products from subcontractors. It is also a good place to meet and arrange further meetings with different sales people from different companies all gathered under the same roof.

As mentioned earlier the machine worked as planned with the exception of that some features of the machine had to be adjusted. The reason and consequences of three problems will be discussed under the headlines below.

### **6.2.1 KUKA CNC**

The problems with the software KUKA CNC, was in all honesty not in our power to predict. Not as university students and not from the assisting APR robot programmer either. It was an unfortunate bug in the robot or the software that disabled the use of the software when the robot was running in auto. The auto mode was needed in order to automate the production cycle that was performed by the APR machine at the Elmia exhibition. Luckily the machine worked well even without KUKA CNC so this did not turn out to be a major issue for the fulfillment of the machine's purpose.

This problem did however highlight an ongoing issue between APR and their main robot subcontractor KUKA. The technical support when things like this happens is very limited from KUKA Nordic and there is no established link between APR and competent engineers at KUKA in Germany. This is something that APR is working on but it is not always simple from an ethical perspective to tell KUKA Nordic "we know more then you about your robots, help us find better support".

### **6.2.2 COMMUNICATION PROTOCOL ISSUE**

The problem that forced us to change from the planned PROFINET protocol to use PROFIBUS was similar to the issue with the KUKA CNC software hard to predict. KUKA was asked if the robot could communicate over PROFINET and their reply was that it could. This was correct the hardware part of the robot was very much able to communicate via PROFINET. The issue here was the software on the robot computer. It could be upgraded but that would require an upgrade of the PC in the robot cabinet. The simpler and less time consuming solution was to communicate over PROFIBUS instead of PROFINET.

I think that these kind of problems are to be expected when working with this kind of technology. The resource that was most lacking in this project and most projects that APR takes on is time!

### 6.2.3 KUKA SAFE OPERATIONS

The problem that occurred with the software KUKA Safe Operations was more related to the projects approach and carrying through. When the APR machine and the usage of these two KUKA software was planned a meeting between me and KUKA Nordic was arranged in Gothenburg. There we discussed the possibilities and requirements of safe operation. They mentioned that “you need a safe plc in order to run Safe Operation”. My response to this was “yes of course we will have a safety PLC, APR always use Jokab Safety’s Safety PLCs in their systems”. Then the discussion went forward about something else.

But in this short conversation that was quoted above a big misunderstanding occurred. What they meant with a safe PLC was that the main PLC of the system should use a safety communication technology developed by PROFIBUS international called PROFISAFE. What I meant was that APR uses a safety PLC to make sure that the air pressure and the electrical power would be safely broken in any case of emergency. Later into the project it turned out that Safe Operation won’t work unless a Siemens PLC is used or at least a PLC with PROFISAFE. This is something that Mitsubishi does not support. There was another ways around this problem. A special extension called X13 can be used with the KUKA robot that enables Safe Operation to communicate with the PLC in a safe way without PROFISAFE. When this problem was discovered it would take too much time and cost too much money to get a hold of the X13 card in time for the exhibition.

This mistake was a sour, but educational one to make. An employee dropped a brilliant quote about assumptions posted below. The quote was looked up and it seems like it comes from rewriting another quote "necessity is the mother of invention," which dates from at least the 17th century. (Wright & Wright , 1977)

“ *Assumption is the mother of all fuckups* ”



## **6.3 THE FUTURE APR AUTOMATION A SUSTAINABLE COMPANY**

APR Automation has so far done an incredible journey from being a sole proprietor taking on automation assignments as a consultant and starting a Nordic sales agency of Colombo spindles. From this to the company that it is today with around 45 fulltime employees, a large assembly hall, an electrical workshop, a mechanical workshop, a construction department and a machine park of several types of processing machines. This change is wonderful but it is also dramatic.

A company of this size has bigger challenges in order to keep the organization above the water in an economic perspective. It will also have higher demands on efficiency and professional handling of customer projects. The level of how advanced projects the company can take on, increases and the customers will pressure APR to the utmost. As if these challenges were not enough a company that grows will also get internal problems with competence, employee turnover and similar personal connected issues. I will discuss these challenges out of a student's perspective with a bachelor from Automation and Mechatronics and a Master's in Production Engineering.

### **6.3.1 COMPANY GROWTH**

The company growth can be studied in many ways. One thing is the increase in economic turnover over the years. Another is the number of full time employees that a company has. A third is what kind of resource a company possesses. I think that the main one to talk about is the number of employees. This is very much connected to the other ones since employees are needed to carry out and get paid for projects that will result in a higher economic turnover. Resources like machines, premises and tools to equip the employees are also needed proportionally to the number of employees a company has.

I think that APR need to invest more time in internal teambuilding and workshops in bigger groups on the ongoing projects. This is a bold proposal since the time never seem to be enough even with overtime by many employees to complete projects in time. What I hope for is that a tighter community and team spirit would help the company perform and avoid heavy delays in the projects. According to me APR is very good at trusting people and handing out big responsibilities. What the company as a whole needs to learn is to also encourage and support each other more. They need to give each other more feedback both good and bad. One important thing that Chalmers has taught me is that all employees need more than money in order to get motivated and feel satisfaction over their work.

### **6.3.2 APR STANDARD**

The ongoing work with creating an APR standard machine regarding both its components and its development process is probably a process that has been ongoing since APR delivered their first machine to IKEA in Swedwood. The difference with this process now and how it has been done since the start of APR and till now, is that it now is formal, structured and on paper. Previously it has only been in the different engineer's heads where they have remembered what worked and what didn't. This is a pretty good method if you keep the same personal and if the communicate all they know with each other extremely well. This is possible when a company is small and the number of people involved in the projects are few. When a company gets bigger this will become harder and finally it will become impossible. This is where I think APR is now. They need to spread in the whole organization that the APR standard is important and that everyone can contribute to making it as good as possible. In the end everyone want the same thing. To deliver superb machines, get paid and come home in time at least once in a while.

## 7 CONCLUSION AND RECOMMENDATIONS

---

### CHAPTER INTRODUCTION

*This chapter is to be held as short and vigorous as possible. Only the core of the thesis will be presented in the conclusion and a few recommendations to the company will be presented in a bullet list.*

---

### 7.1 RECOMMENDATIONS TO APR

Below a short bullet list will follow with concrete recommendations to APR Automation. There is not a strict scientific anchoring to all of these suggestions. They should be seen as nothing more and nothing less than the recommendations from me as a graduating Master's student in production engineering.

- ✓ Keep the APR standard development in motion. Involve more people into it as well and set up some concrete deadlines and meetings for going through the standardization of different areas.
- ✓ Update the standards and use them for continuous improvements. APR needs to be on the edge of high end technology so no part of the machine can be outdated.
- ✓ Flatten the organization. Make it less them down on the floor and us up in the offices. Have recurring meetings with all employees. It could even be lunch meetings but make everyone involved and not just passive listeners.
- ✓ Try to create a good philosophy at the company. It may sound cheesy but it can help to create a good working culture and a common goal.
- ✓ Start documenting internally and follow up on completed projects. For example it could save time to keep project diaries. Going back to look up certain meetings and decisions would be very easy.

Good luck in the future!

### 7.2 CONCLUSION

This Master's thesis project's primary objective of creating a HMI standard for APR Automation has been fulfilled. The secondary objective is also fulfilled, to develop, build and program a robot cell for the Elmia Automation Exhibition in Jönköping.

The conclusions that can be drawn from this work is that there is much potential in creating a HMI standard. The end product from APR to their customers will have higher quality than previously and the development phase will shorten. It is also important to underline that there is much more work to be done within this area in the company. This project does not leave a complete product but it is rather a step in the right direction for the company.

The conclusions from the Elmia Automation fair was that there is good potential in the components that are selected for the APR standard. They work well together and many of them have additional features that the time frame of this project did not allow us to dig deeper into. It can also be concluded that it is possible to put a whole system together, for this type of purposes for a very low pricing thanks to many helpful sponsors.

## 8 REFERENCES

---

- Abele, E., Altintas, Y. & Brecher, C., 2010. Machine tool spindle units. In: *CIRP Annals - Manufacturing Technology*. Germany: Institute of Production Management, pp. 781-802.
- Bligård, L.-O., 2011. *Utvecklingsprocessen ur ett människamaskinperspektiv*. Gothenburg: The institution for product- and production development.
- Bohgard, M., 2011. *Work and technology on the human's conditions*. Stockholm: Prevent.
- Bryman, A. & Bell, E., 2011. *Business research methods*. 3. ed. ed. USA: Oxford University Press.
- Collins, K., 2007. *PLC programming for industrial automation*. Liskeard: s.n.
- Drivteknik, 2007-2014. *Drivteknikportal*. [Online]  
Available at: <http://www.drivteknik.nu/skolan/industriell-kommunikation>  
[Accessed 18 June 2014].
- European Commission, 2006. *EC.Europa*. [Online]  
Available at:  
[http://ec.europa.eu/enterprise/sectors/mechanical/documents/legislation/machinery/index\\_en.htm](http://ec.europa.eu/enterprise/sectors/mechanical/documents/legislation/machinery/index_en.htm)  
[Accessed 18 June 2014].
- FT.com, 2014. *Automation and the threat to jobs*. London: The Financial Times Limited.
- Gruhn, P., 2011. *Human Machine Interface (HMI) Design: The Good, The Bad, and The Ugly (and what makes them so)*. Houston, ICS Triplex.
- Huntzinger, J. R., 2007. *Lean Cost Management*. s.l.:J. Ross.
- KUKA, N., 2013. *Kuka-robotics*. [Online]  
Available at: [http://www.kuka-robotics.com/en/products/software/hub\\_technologies/start.htm](http://www.kuka-robotics.com/en/products/software/hub_technologies/start.htm)  
[Accessed 18 June 2014].
- Lantz, A., 2007. *Intervjumetodik*. Lund: Studentlitteratur.
- Liker, J. K. & M. D., 2006. *The Toyota way fieldbook : a practical guide for implementing Toyota's 4Ps*. New York: McGraw-Hill.
- Mitsubishi Electric, E., 2013. *GOT2000 The next level of graphical operator terminals*. Germany: FA - European Business Group.
- Mitsubishi Electric, S., 2013. *GT Works3*, Lund: Mitsubishi Electrics.
- Popovic, M., 2006. *Communication Protocol Engineering*. s.l.:CRC Press.
- Sandberg, B., 2013. *Mitsubishi PLC's*, Lund: Mitsubishi Electric Europe, Factory Automation, Sweden.
- Wänlund, H., 2012. *Svenskenergi*. [Online]  
Available at: <http://www.svenskenergi.se/Elfakta/Elproduktion/>  
[Accessed 18 July 2014].

A – PICTURES OF THE EXHIBITION MACHINE

