



# Sorption Filter Columns to Remove Colloidal and Dissolved Pollutants from Stormwater

Master's Thesis in the Master's Programme Infrastructure and Environmental Engineering

FELICIA ALENIUS  
ANDREAS HERMANSSON



MASTER'S THESIS BOMX02-16-51

# Sorption Filter Columns to Remove Colloidal and Dissolved Pollutants from Stormwater

*Master's Thesis in the Master's Programme Infrastructure and Environmental Engineering*

FELICIA ALENIUS  
ANDREAS HERMANSSON

Department of Civil and Environmental Engineering  
*Division of Water Environment Technology*  
CHALMERS UNIVERSITY OF TECHNOLOGY  
Gothenburg, Sweden 2016



Sorption Filter Columns to Remove Colloidal and Dissolved Pollutants from Stormwater

*Master's Thesis in the Master's Programme Infrastructure and Environmental Engineering*

FELICIA ALENIUS

ANDREAS HERMANSSON

© FELICIA ALENIUS, ANDREAS HERMANSSON, 2016

Examensarbete BOMX02-16-51X02-16-51/ Institutionen för bygg- och miljöteknik, Chalmers tekniska högskola 2016

Department of Civil and Environmental Engineering

Division of Water Environment Technology

Chalmers University of Technology

SE-412 96 Gothenburg

Sweden

Telephone: + 46 (0)31-772 1000

Cover:

Picture collage including; pilot plant, sorption columns and sorption materials. Taken by the authors during the project.

Department of Civil and Environmental Engineering, Gothenburg, Sweden, 2016



# Sorption Filter Columns to Remove Colloidal and Dissolved Pollutants from Stormwater

*Master's thesis in the Master's Programme Infrastructure and Environmental Engineering*

FELICIA ALENIUS

ANDREAS HERMANSSON

Department of Civil and Environmental Engineering

Division Water Environment Technology

Chalmers University of Technology

## ABSTRACT

Recently, stormwater has been considered as a major pollution source for urban water courses. Urban stormwater contains metals and organic pollutants (OPs) that are persistent in the environment and that can be toxic to organisms and humans even in low concentrations. Currently, the most common treatment for stormwater, such as sedimentation and filtration, focuses on particle separation. However, it has recently been shown that OPs are present in dissolved and colloidal form in stormwater and might even be more abundant in these forms than attached to particles. Studies have also shown that adsorption filter is a promising method for removal of colloidal and dissolved organic pollutants.

This master thesis was performed within a research project carried out at the Department of Civil and Environmental Engineering at Chalmers University of Technology. The research project is mainly aimed at studying the removal of OPs from stormwater, however, removal of metals will also be investigated. The aim of this thesis project is to plan, design, construct and start up a pilot plant at the Järnbrott stormwater pond in Gothenburg with the purpose of investigating efficiency of selected sorption filter materials for the removal of dissolved and colloidal organic pollutants and toxic metals from urban runoff. A literature study including relevant pollutants in stormwater, pilot plant design and suggestions of filter material was performed to optimise the design the pilot plant.

Three filter materials were chosen, characterised and placed in columns in the pilot plant, granulated activated carbon (GAC), *Sphagnum* peat and pine (*Pinus sylvestris*) bark. The determined design of the pilot plant using gravity filtration was successfully implemented and functional, but showed to have limitations in desired and expected flows through the filter media. This was believed to be caused by clogging of the sorption filters. The characterisation of the sorption materials indicate that GAC will have the greatest sorption capacity, mostly due to its high surface area which is the key quality parameter for sorption. Future results from the pilot plant are needed to establish the removal efficiency for metals and OPs in colloidal and dissolved forms in the selected filter media.

**Key words:** Organic pollutants, toxic metals, sorption capacity, environmental engineering, field study, pilot plant, column filters

# Sorptionfilter för avskiljning av kolloidala och lösta föroreningar i dagvatten

Examensarbete inom *Masterprogrammet Infrastruktur och Miljöteknik*

FELICIA ALENIUS

ANDREAS HERMANSSON

Institutionen för Bygg- och miljöteknik

Avdelningen för Vatten Miljö Teknik

Chalmers tekniska högskola

## SAMMANFATTNING

Dagvatten anses idag vara starkt bidragande till förorening av stadsnära vattendrag p.g.a. innehållet av metaller och långlivade organiska miljögifter vilka redan i små mängder kan vara skadliga för både organismer och människor. Metoder för rening av dagvatten är idag främst utformade för borttagning av partiklar. Studier har dock visat att organiska miljögifter även förekommer i lösta och kolloidala former i vatten. Vidare har studier visat att sorptionsteknik är en lovande metod för avskiljning av kolloidala och lösta föroreningar.

Detta examensarbete har utförts inom ramen för ett forskningsprojekt vid Chalmers tekniska högskola, Institutionen för Bygg- och miljöteknik. Syftet med projektet är att studera avskiljning av lösta och kolloidala organiska miljögifter i dagvatten med hjälp av sorptionsteknik. Examensarbetet har omfattat att designa, konstruera och starta upp en pilotanläggning vid Järnbrottsdammarna i Göteborg, där olika sorptionsmaterial kan testas och utvärderas med hänsyn till avskiljning av lösta och kolloidala organiska miljögifter samt metaller från dagvatten. En litteraturstudie har genomförts för att identifiera relevanta föroreningar i dagvatten, ta fram data för att designa pilotanläggningen, samt för att ge förslag på sorptionsmaterial för att optimera pilotanläggningens funktion.

Granulerat aktivt kol (GAC), *Sphagnum* torv och tallbark (*Pinus sylvestris*) valdes som sorptionsmaterial och karakteriserades. Föreslagen design på pilotanläggning med gravitationsfiltrering genom kolonner konstruerades och tester kördes för att optimera flöden genom filterbäddarna i kolonnerna. Flödet genom bäddmaterialet i kolonnerna motsvarade dock inte önskat flöde, troligtvis p.g.a. att filtermaterialen blev igensatta av partiklar i vattnet. Karakteriseringen av materialen visade att GAC bör ha den högsta sorptionsförmågan, främst beroende på dess höga specifika yta. Framtida resultat från pilotanläggningen krävs för att göra en bedömning av hur effektivt materialen avskiljer metaller och organiska miljögifter.

Nyckelord: Sorptionkapacitet, adsorption, organiska föroreningar, metaller, miljöteknik, fältstudie, pilotanläggning, filterkolonn



# Contents

ABSTRACT	III
SAMMANFATTNING	IV
CONTENTS	V
PREFACE	VII
LIST OF ABBREVIATIONS	VIII
1 INTRODUCTION	1
1.1 Aim	2
1.2 Limitations	2
2 LITERATURE REVIEW	3
2.1 Pollutants in stormwater	3
2.1.1 Persistent organic pollutant	3
2.1.2 Metals	9
2.2 Sorption	10
2.2.1 Equilibrium and sorption isotherms	11
2.2.2 Sorption materials	12
2.3 Filtration	15
2.3.1 Gravity filtration using granular media	15
2.3.2 Backwashing	16
2.3.3 Ideal filter media	17
2.3.4 Sorption – design aspects	17
3 CASE STUDY	19
3.1 Järnbrott area	19
3.2 Järnbrott stormwater ponds	19
4 METHOD	22
4.1 Material characterisation	22
4.1.1 Hydraulic loading rate	22
4.1.2 Physical and chemical properties	23
4.2 Pilot plant	23
4.2.1 Design and implementation	23
4.2.2 Sampling	24
5 RESULTS AND DISCUSSION	26
5.1 Material characterisation	26
5.2 Pilot plant	29
5.2.1 Pilot plant initial operating results	32

5.2.2	Results of the initial water quality analysis	35
5.3	Future aspects	36
6	CONCLUSIONS	39
7	REFERENCES	40
	APPENDIX I– PRODUCER INFORMATION ON SORPTION MATERIAL	A
	APPENDIX II – CALCULATION OF HYDRAULIC LOADING RATE	J
	APPENDIX III – FULL RESULTS FROM MATERIAL CHARACTERISATION	K
	APPENDIX IV – PILOT PLANT OPERATION JOURNAL	N
	APPENDIX V – SCHEMATIC FIGURE AND FLOW CHART	R
	APPENDIX VI – FULL RESULTS FROM INITIAL WATER ANALYSIS	T
	APPENDIX VII – RESULTS REFERENCE WATER SAMPLE	U

## Preface

In this study a pilot plant has been designed and constructed at the Järnbrott stormwater pond in Gothenburg, Sweden. The purpose of the plant is to enable investigation of removal efficiencies for common stormwater pollutants using sorption filter columns. The work is part of a research project concerning removal of the dissolved and colloidal fraction of organic pollutants from stormwater. The project has been carried out at the Department of Civil and Environmental Engineering, Water Environment Technology, Chalmers University of Technology, Sweden.

This master thesis have been performed during spring 2016 with the much valued assistance of supervisor Karin Björklund and examiner Ann-Margret Strömwall. We would like to give a special thank you to Lars-Ove Sörman for his work with the planning and construction of the plant and to Mona Pålsson for all her, much needed, support in the laboratory. We would also like to express our gratitude towards Kretslopp och vatten in Gothenburg for allowing us to take over the pilot plant, especially Hilde Hagen Björngaas who helped organising transportation, installation of electricity and much more. Thank you also to Uponor who supplied us with pipe material.

As always, thanks to our families and friends, and to all the people who made our time at Chalmers a great experience, and of course a lot of fun.

Gothenburg June 2016

Felicia Alenius and Andreas Hermansson

## List of abbreviations

Al	Aluminum
Cd	Cadmium
CEC	Cation-exchange capacity
Cr	Chromium
Cu	Copper
DEHP	Bis-(2-ethylhexyl)-phthalate
DIDP	Diisodecyl phthalate
DINP	Diisononyl phthalate
DOC	Dissolved organic carbon
Fe	Iron
GAC	Granulated activated carbon
Hg	Mercury
IC	Ion chromatograph
ICP-MS	Inductively coupled plasma mass spectrometry
LLE	Liquid-liquid extraction
LOI	Loss on ignition
Mn	Manganese
Ni	Nickel
OP	Organic pollutant
Oxy-PAH	Oxygenated polycyclic aromatic hydrocarbon
PAC	Powdered activated carbon
PAH	Polycyclic aromatic hydrocarbon
Pb	Lead
PCB	Polychlorinated biphenyls
PHC	Petroleum hydrocarbon
POP	Persistent organic pollutant
PVC	Polyvinyl chloride plastic
TOC	Total organic carbon
TSS	Total suspended solids
Zn	Zink

# 1 Introduction

Urbanisation and the associated land use modifications have been known to alter the aquatic environment in cities, causing increased volumes of stormwater, increased flooding and deterioration of water quality (Zgheib, et al., 2012). Stormwater has recently been considered as a major pollution source for urban water courses (Kayhanian, et al., 2007; German & Svensson, 2002; Vaze & Chiew, 2004). Urban stormwater, particularly runoff from roads, contains toxic metals that are not degradable in the environment (Genc-Fuhrman, et al., 2006). It is also known that stormwater commonly contains organic pollutants (OPs) such as polycyclic aromatic hydrocarbons (PAHs), including oxygenated PAHs, phthalates and total petroleum hydrocarbons (TPH), which can be toxic to organisms even in low concentrations (Swedish EPA, 2014). Organic pollutants may be persistent in the environment, transported long distances, bioaccumulating and have the ability to biomagnify in living organisms, they may also be carcinogenic and hormone disruptive (Swedish Water Authorities, 2015). Most of the OPs in the urban environment are the result of human activity such as combustion, vehicle erosion and exhaust, wear of rubber tires, and the use of pesticides, plastic materials, medical products, paints, building material, chemical products and many everyday products.

During the last decade, stricter directives regarding water quality standards have been implemented by national and European instances, such as the European water framework directive (Swedish EPA, 2014; Coquery, et al., 2005). The water framework directive list of prioritised pollutants include substances categorised as PAHs, phthalates and TPH. These directives specifies the need to reduce pollution from both point sources, such as wastewater effluent, and diffuse sources, e.g. road runoff, of which the latter is considered as the main pollutant source for water bodies in the EU (European Union, 2015). Such regulations further increases the incentive to develop and improve technologies for treatment of polluted stormwater, and especially OPs, of which some compounds have attracted attention due to their high toxicity (Heudorf, et al., 2007).

Traditionally, the majority of urban stormwater is discharged to receiving water without treatment (Björklund & Li, 2015). There is a general assumption that organic contaminants will attach to particles in the water and therefore be removed by particle separation, such as sedimentation and filtration, which is currently the most common way of treating stormwater. However, it has recently been shown that OPs are present in dissolved and colloidal form in stormwater and might even be more abundant in these forms than attached to particles (Zgheib, et al., 2011; Kalmykova, et al., 2013). For example, a study on particle phase distribution of polycyclic aromatic hydrocarbons in stormwater by Nielsen et al. (2015), found that 45 % of the contaminants were present in the colloidal and dissolved fractions. Since colloids (1-1000 nm) do not settle they may act as carriers for organic compounds and this finding would suggest that particle separation is not an efficient method of removing all organic pollutants (Kalmykova, et al., 2014). Therefore, complementary treatment techniques for stormwater needs to be investigated.

In conventional water treatment, the most common techniques for removal of colloidal and dissolved constituents are membrane filtration, such as micro-, ultra- and nanofiltration (Chalmers WET, 2014). These techniques often require sufficient pre-

treatment to avoid membrane clogging and can have high energy consumption as they require hydraulic pressure applied on the membrane (Metcalf & Eddy, 2004). It is therefore of interest to investigate alternative treatment options. Studies by Liu et al. (2010) and Ray et al. (2006) have shown that adsorption filters is a promising method for removal of colloidal and dissolved organic pollutants given that an effective adsorption and filtration media is found.

## 1.1 Aim

The aim of this thesis project is to plan, design, construct and start up a pilot plant with sorption filter columns for removal of dissolved and colloidal OPs and toxic metals from urban runoff. This master thesis is being performed within a research project carried out at the Department of Civil and Environmental Engineering at Chalmers University of Technology. The research project is mainly focused at studying the removal of organic pollutants from stormwater, however, removal of metals will also be investigated.

More specific the goals of the thesis project are to:

- Compile a literature study describing stormwater pollutants in urban runoff.
- Search for literature and study sorption filter techniques for treatment of contaminated water
- Research appropriate sorption media for removal of contaminants in the dissolved and colloidal phase. Three sorption materials will be chosen for the study based on their suitability for removal of the pollutants described in the literature.
- Determine an appropriate design for sorption filter columns in the pilot plant for the chosen filter media.
- Perform a physical and chemical characterisation of the chosen filter media.
- Plan and initiate investigation of the filter material removal efficiency of OPs such as polycyclic aromatic hydrocarbons (PAHs), including oxygenated PAHs, phthalates and petroleum hydrocarbons (PHC).
- Plan and initiate investigation of the filter material removal efficiency of the toxic metals cadmium, copper, chromium, lead, zinc and nickel.

## 1.2 Limitations

For this study only stormwater from the Järnbrott pond located in the city of Gothenburg in Sweden is evaluated. The water consists of runoff from residential areas as well as roads with heavy traffic and an industrial area located in the drainage area. Other types of runoff or leachate, or other locations were not considered. Further, the effect of the pond as a pre-treatment step was disregarded since the pilot plant will be located at the inlet of the pond.

## 2 Literature review

The literature study for this project is aimed to extend the knowledge about common metals and OPs in stormwater, the processes of sorption and filtration in order to optimise the design and construction of the pilot plant.

### 2.1 Pollutants in stormwater

In urban runoff, the process of accumulation and reduction of pollutants is often referred to as build-up and wash-off processes from impervious surfaces (Barbé, et al., 1996). The build-up of pollutants on urban roads occurs over dry days and is relatively quick on impervious surfaces after rain events (Vaze & Chiew, 2002). The accumulation does however slow down after a few days due to redistribution of pollutants by factors as wind and degradation.

The pollution load in stormwater generally increases with increased urbanisation and often contain numerous substances that can be toxic for receiving waters (Erickson, et al., 2013). Some pollutants of greater concern regarding negative biological impacts are metals, hydrocarbons, nutrients, bacteria and oxygen-demanding substances. Pollutants in the water phase can be present in dissolved form, or attached to particles and colloids. Colloids are usually defined to have a size of 1-1000 nm. About 50 % of the total metal load have shown to be dissolved in the water, while hydrocarbons in stormwater often are assumed to be particulate bound (Erickson, et al., 2013).

#### 2.1.1 Persistent organic pollutant

Persistent organic pollutants (POPs) are organic compounds, natural or anthropogenic, that can resist photolytic, chemical and biological degradation (ICPS, 1995). There are thousands of compounds of different origins that can be classified as POPs (O'Sullivan & Megson, 2014). The sources are generally classified as agrochemical (pesticides); synthesised for industrial use; and unintentional by-products, usually produced by combustion or synthesis of other chemicals.

Because there is such a multitude of different POPs and many different exposure routes, it is difficult to establish direct links between exposure to POPs and specific health problems (Abdallah, 2015). However, adverse effects to wildlife such as immunotoxicity, dermal aberrations, impairment of reproductive performance, deformations, hormonal deficiencies, cancer, increased mortality and overall population decline as a result of exposure to POPs have been indicated in both laboratory and field studies. Humans are mainly exposed to POPs through food, but less common exposure routes such as direct contact and drinking contaminated water have also been identified (US EPA, 2009). POPs have been linked to reproductive, developmental, behavioural, neurologic, endocrine and immunologic health effects in humans.

Some of the key properties that gives the POPs their characteristic behaviour include low water solubility, and high octanol water partition coefficient,  $K_{OW}$ , which means that the compounds are hydrophobic and explains the tendency for finding them on soil or sediment particles (O'Sullivan & Megson, 2014). A compound with a high  $K_{OW}$  is less polar and more lipophilic than a compound with a low  $K_{OW}$ , most POPs have a

high  $K_{OW}$  ( $\log K_{OW} > 3$ ). Because many POPs are semi-volatile, they can undergo long-range atmospheric transportation either in the vapour phase or sorbed on atmospheric particles (ICPS, 1995). This is the reason why POPs are found in regions where they have never been used or produced (Abdallah, 2015).

Because many POPs have a hydrophobic and lipophilic nature they are difficult to eliminate when they have entered a biological system (O'Sullivan & Megson, 2014). Many compounds tend to partition into lipids, which means that they can accumulate in the tissue of living organisms (US EPA, 2009). This process is called bioaccumulation. Biomagnification occurs when the concentration of contaminant increases higher up in the food chain. This means that even small releases of POPs can have a significant impact on the predators at the top of the food chain, e.g. marine mammals and birds of prey.

Separation of the total, particle bound, colloid bound and truly dissolved fractions of POPs in water can be done in order to investigate the concentrations of the pollutants in the different fractions (Nielsen et al., 2015). This can be achieved by first determining the total concentrations in unfiltered samples using a solvent liquid-liquid extraction (LLE) (Kalmykova et al., 2013). The particle bound concentrations are obtained by filtering the samples through a 0.7  $\mu\text{m}$  glass-fibre filter followed by LLE. The dissolved fraction, consisting of the truly dissolved and the colloid bound fractions, will pass through the filter and the particle bound concentration is acquired by subtracting the dissolved fraction from the total concentration (mass balance). The method for determining the truly dissolved and the colloidal concentrations vary slightly between compounds. For polycyclic aromatic hydrocarbons and phthalates, which are presented further down in this chapter, the truly dissolved fraction is allowed to sorb on  $\text{C}_{18}$  SPE (solid-phase extraction) disks. The colloid bound concentration is calculated through mass balance, subtracting the absorbed truly dissolved fraction from the earlier acquired dissolved fraction.

### **2.1.1.1 Hydrocarbons**

Hydrocarbons is a group of chemical compounds which consists of hydrogen and carbon (Breacher, 2006; Nationalencyklopedin, 2016). General characteristics of hydrocarbons are that they are non-polar, hydrophobic and lipophilic. Molecules with these properties tend to dissolve in fat and not water, while the non-polarity of the hydrocarbons means that they preferably bond with other non-polar substances. The water solubility generally decreases with increased molecular weight (Breacher, 2006).

#### **PHC**

One important group of hydrocarbons are the petroleum hydrocarbons (PHCs) which mainly originates from crude oil (TPH Criteria Working Group, 1998; Breacher, 2006; Nationalencyklopedin, 2016). Minor sources of PHC are coal and bitumen. The refined products are widely used in both industry and by consumers, for example gasoline, aviation fuels, lubricating oils and solvents. PHCs are also emitted from both gasoline and diesel vehicles, where gasoline emits lighter PHCs than diesel (Rogge, et al., 1993). The properties of PHCs depend on the molecular weight, connected to the number of carbon atoms. To clarify the anthropogenic origin of PHCs, different commercial products (major fractions) from distillation of crude oil are presented together with their



carbon number and examples of application (petroleum.co.uk, 2015; University of York, 2013):

- Gas – propane and butane C<sub>1</sub>-C<sub>4</sub>
- Naphtha – petrol and chemicals C<sub>5</sub>-C<sub>10</sub>
- Kerosene – jet fuels, paraffin and domestic oil C<sub>10</sub>-C<sub>16</sub>
- Gas oil – diesel fuel, fuel oil C<sub>14</sub>-C<sub>20</sub>
- Distillation residue – lubricating oil, waxes, bitumen (cracking) > C<sub>20</sub> up to several hundred

The environmental fate of PHC depends on the molecular weight and lighter molecules are more likely to be transported by air or water (Breacher, 2006). Larger PHC are more persistent in the environment. Known toxic effects of PHCs are that some, but not all, are carcinogenic, depending on composition. Further effects are reproductive and developmental toxicity which has been observed in animal studies for some PHC.

As the total amount of different PHC compounds and complexes exceeds several hundred, it is impractical to measure them separately (ATSDR, 2011). PHCs are instead often referred to and measured as Total Petroleum Hydrocarbons (TPH) which includes the total amount of PHCs.

TPH consists of three major groups, (TPH Criteria Working Group, 1998)

- Saturated hydrocarbons, with all remaining bonds filled with hydrogen atoms, which is the main class of compounds found in petroleum products. There are two configurations: the aliphatic (alkane) which is a straight or branched molecule and the alicyclic (cycloalkane) where the molecule contains at least one saturated ring.
- Unsaturated hydrocarbons, multiple bonded hydrocarbons, two or more bonds. These compounds are not found in crude oil, but are produced in one of the refining processes called cracking, where heavier molecules are cracked into smaller ones. They then form multiple bonds as there is not enough hydrogen present to saturate the molecule.
- Aromatic compounds are a special class of unsaturated hydrocarbons, based on an aromatic ring structure. When two or more aromatic rings are fused together, they form a polycyclic aromatic hydrocarbon (PAH), which is of special environmental concern and is separately presented in the following section. All crude oil and petroleum products, except for a few solvents, contain aromatics.

Aromatic compounds are usually more polar than aliphatic, and therefore tend to be more soluble in water as well as less volatile (WHO, 2005). Persistence increases as the boiling point increases. Only a small proportion of PHCs is soluble in water, therefore PHC in water is not representative for PHC in petroleum oil. Primary concern for water, is spills of oil. If water is contaminated, the petroleum present will be determined by the water solubility. In general, aromatic, low molecular weight are the most water soluble compounds.

Stormwater runoff from highways have shown to be a major source of PHCs to waterbodies. An early study performed by (Hoffman, et al., 1984) showed that 88-96 % of the PHCs were particulate bound. The PHCs did however not correspond as well

to particulate matter as metals (Cu, Pb and Fe). The study further showed that 16 % of the PHC and 77 % of the PAH input to the river originated from highway runoff.

## **PAH**

As mentioned in the previous section, polycyclic aromatic hydrocarbons, PAHs, are substances that consist of aromatic rings made up by carbon and hydrogen. This group contains several hundred different chemical substances. PAHs are created during incomplete combustion of organic material, when the amount of oxygen needed for carbon or hydrocarbon to transform into carbon dioxide is lacking (Swedish EPA, 2014). Factors that benefit the production of PAHs include lack of oxygen, temperatures between 400 and 800 °C and the presence of aromatic and unsaturated hydrocarbons in the original material (National Food Agency, Sweden, 2015).

The largest part, 77%, of the PAH-emissions to air in Sweden, are caused by heating of private homes as well as forestry and agricultural real estate by burning biomass e.g. wood (Swedish EPA, 2016). Industry is responsible for 17% of the air emissions, however, because of the implementation of stricter rules for industries these emissions have decreased with 72% since 1990. Of the remaining air emission, 4% comes from the production of electricity and district heating and 2% is due to other miscellaneous sources, including traffic. In recent years the size of the emissions from traffic remain the same, even as the development of catalysts has reduced the emissions per car and kilometre substantially, since traffic increases continuously (Boström, et al., 2002). Traditionally, diesel engines are believed to emit larger amounts of PAHs than petrol engines which is due to the fact that diesel engines also emit larger amounts of soot and particles (Swedish EPA, 2007). There are some other emission sources of PAHs also connected to vehicular use and road traffic that are harder to quantify, examples of these are abrasions of rubber tires, asphalt road surfaced and brake linings (Ravindra et al., 2008). Even if the contribution from traffic related emission sources to the total emissions of PAHs is small, they are important to recognize when investigating the water quality of road runoff. It has been found that the major sources of PAHs in stormwater are vehicle exhaust as well as road and tyre materials (Siopi, 2015). More information on PAH in road runoff, emitted from traffic sources, can be found in a thesis project performed at Chalmers University of Technology by Siopi (2015). PAHs are also created naturally, e.g. during forest fires and volcanic eruption, but the natural contribution of PAHs to the environment is so small in comparison to the human contribution that it can be considered negligible.

PAHs are stable in the environment, hydrophobic, lipophilic and have a tendency to concentrate in body fat (Samanta, et al., 2002). In general the volatility and the water solubility of PAHs decreases with increasing size and weight of the molecule (Swedish EPA, 2007). This means that the smaller PAHs are more likely to spread in the water and gas phases in the environment and the larger ones are more likely to be found in soil and sediment (Swedish EPA, 2007). PAHs can bioaccumulate and water ecosystems tend to be extra vulnerable since many PAHs amass in aquatic invertebrates (Swedish EPA, 2010). Water ecosystems close to the emission sources are the most exposed to PAHs (Swedish EPA, 2007).

Several PAHs are toxic to the environment as well as to human health, they can be acutely toxic, genotoxic, carcinogenic or a combination of the three (Swedish EPA, 2007). In fact, PAHs is the largest group of carcinogenic substances known today

(Swedish EPA, 2010). A multitude of studies have shown strong correlations between exposure to PAH-containing materials and the occurrence of carcinogenic tumours (Boström, et al., 2002). The four PAHs that are regarded as most toxic to health is benzo(a)pyrene, benzo(b)fluoranthene, benzo(k)fluoranthene and indeno(1,2,3-cd)pyrene (Swedish EPA, 2016).

PAHs are present almost everywhere in the environment (Swedish EPA, 2007), and have been found in comparatively high concentrations in urban stormwater (Bressy, et al., 2012; Zgheib, et al., 2012). A study on urban snow performed by Björklund et al. (2011) showed that PAHs were present in high concentrations in the area around the Järnbrott pond.

### **Oxygenated PAH**

Oxygenated PAHs, often abbreviated oxy-PAHs, are PAHs that have one or more carbonylic oxygens attached to the ring structure (Lundstedt, et al., 2007). Oxy-PAHs can be created directly in the combustion process or by reactions with PAHs in the atmosphere, soil and water (Swedish EPA, 2007). During these reactions several different compounds are created. Oxy-PAHs are of particular concern since they appear to be persistent and could accumulate in the environment when PAHs are degraded (Lundstedt, et al., 2007). The dominant source for oxy-PAHs in an urban environment is emissions from road traffic and the size of the emissions are comparable to PAHs emissions (Brorström-Lundén, et al., 2010).

In the atmosphere oxidants, such as ozone and hydroxyl radicals, that are strong enough to oxidise PAHs are created through photolytic reactions caused by the sunlight (Swedish EPA, 2007). The sunlight can also be absorbed by the PAH molecules and may lead to a reaction with the oxygen in the air. In soil and water the oxidation of PAHs results from chemical oxidation, similar to the process in the atmosphere, or biological transformations (Lundstedt, et al., 2007). The biological transformations are primarily performed by enzymatic systems of microorganisms such as bacteria and fungi which, for example, can use them as a carbon or energy source. There are some concerns regarding unintentional formation of oxy-PAHs, several studies have shown that oxy-PAH can accumulate during remediation processes meant to promote PAH degradation (Lundstedt, et al., 2007).

Typically, the oxy-PAHs have similar properties as PAHs, they are lipophilic and semi-volatile (Swedish EPA, 2007). Oxy-PAHs, however, are more polar than their corresponding PAH, which means that they are more water soluble and less volatile (Brorström-Lundén, et al., 2010). Oxy-PAHs are more apt to wet deposition and will also dissolve in surface water in a larger degree than PAHs (Swedish EPA, 2007). Like PAHs, oxy-PAHs are stable in the environment and can therefore accumulate to rather large quantities in soil and water.

The adverse effects of oxy-PAH differ between compounds, but a number of oxy-PAHs have shown acute toxicity to aquatic bacteria, invertebrates, microalgae and plants (Lundstedt, et al., 2007). Further, several studies have shown that oxy-PAHs can induce oxidative stress, have hormone disruptive, cytotoxic and mutagenic effects in the cellular system of mammals (Swedish EPA, 2007). Studies have also shown that in many cases, the oxy-PAHs are more toxic than their parent PAH (Lundstedt, et al., 2007).

### 2.1.1.2 Phthalates

Phthalates, or phthalate esters, is a group of chemical substances based on phthalic acid (Socialstyrelsen, 2009). The substance is produced when the phthalic ester reacts with an alcohol (Swedish Chemicals Agency, 2014). Phthalates are most commonly used as softeners in plastic products, often called plasticisers, but can also be used as solvents for other materials (US CDC, 2015). Phthalates are widely used in polyvinyl chloride plastic (PVC) products such as plastic packaging film and sheets, garden hoses, medical tubing and some toys, but can also be found in detergents, adhesives, automotive plastics, plastic clothing and personal hygiene products such as soaps shampoos, hair spray and nail polish. The phthalates are not chemically bound to the plastic and can therefore leach from products and waste and thus spread in the environment (Socialstyrelsen, 2009). The product may leach phthalates during its entire lifetime (Swedish EPA, 2009) .

Historically, the most commonly used phthalate in Sweden is bis-(2-ethylhexyl)-phthalate (DEHP), more than half the consumption of phthalates was earlier made up by DEHP (Socialstyrelsen, 2009). DEHP is regarded as one of the most hazardous (Swedish EPA, 2009) and is also the most studied phthalate (Socialstyrelsen, 2009). In later years, phthalates such as diisodecyl phthalate (DIDP) and diisononyl phthalate (DINP) have become more frequently used because the use of DEHP has been regulated for certain products.

Phthalates can be divided into three groups based on their physio-chemical and toxicological properties (Swedish Chemicals Agency, 2014). The groups are formed after the number of carbon atoms in the ester group, which is determined by the alcohol from which it is synthesised. The groups are characterised as:

- a) **High molecular weight (HMW) phthalates** have carbon chains with 7 to 13 carbon atoms ( $C_7 - C_{13}$ ) and have a very low solubility in water. DINP and DIDP are examples of HMW phthalates.
- b) **Low molecular weight (LMW) phthalates** contain carbon chains with 3 to 6 carbon atoms ( $C_3 - C_7$ ). The solubility in water is higher than for the HMW phthalates and toxicity for humans as well as reproductive toxicity is very common.
- c) **Other phthalates** are the phthalates containing less than 3 carbon atoms in the carbon chain. These phthalates are more volatile, have a higher solubility in water and potential aquatic toxicity than HMW and LMW phthalates, however, the toxicity for humans are generally lower than for LMW phthalates.

The toxicity of a phthalate is generally dependent on the length of the carbon chain, a shorter carbon chain usually means a more toxic phthalate (Swedish Chemicals Agency, 2014). The phthalates with the strongest link to reproductive toxicity have a carbon chain consisting of 4 – 6 carbon atoms.

Phthalates are anthropogenic compounds and have been found in low concentrations in almost every environment on the planet (Socialstyrelsen, 2009). Studies have shown that they are also present in stormwater (Björklund, et al., 2009; Clara, et al., 2010). However, the concentrations of phthalates varied greatly between samples. In a study performed on Swedish stormwater, DIDP and DINP were found in the highest concentrations, which could be a result of the increasing use of these substances in

Sweden and their higher persistence compared to other phthalates (Björklund, et al., 2009). The results of Björklund et al. (2009) also suggest that phthalates may occur in higher concentrations in road runoff than in runoff from residential areas.

### 2.1.2 Metals

The presence and concentrations of different metals in stormwater is greatly dependent on location, catchment area and precipitation (Lavieille, 2005). However, alarming concentrations of cadmium (Cd), copper (Cu), chromium (Cr), lead (Pb), zinc (Zn) and nickel (Ni) in urban runoff have been found in several studies (Reddy, et al., 2014). These metals are the ones considered most relevant to include in studies on stormwater (Ahlman, 2006).

Transport, transformation and effects of pollutants are highly influenced on their distribution between solid and liquid phase (Hvitved-Jacobsen, et al., 2010). In urban drainage system the interactions between the solid and liquid phase dominates how efficiently stormwater pollutants can be removed by filtration and retention.

Different species of metals further varies in toxicity as they can form complexes with organic and inorganic substances (Hvitved-Jacobsen et al, 2010). Removal processes in both natural and treatment systems depends on the nature of species as the charge of a given metal species can affect the sorption on to the surface of a particle. Speciation of pollutants are therefore important as the bioavailability and biological effects of pollutants are highly dependent on the metals existing as free ions, complexes or solids. Metals associated with solids, or occurring as complexes generally shows reduced bioavailability and biological effects. The speciation of metals in water are mainly affected by acidity and alkalinity, substance concentration and the redox potential. To predict and analyse metal speciation and formation of metal complexes a widely used method is the MINTEQ-model. The model uses chemical equilibrium to calculate metal speciation and solubility in natural waters.

The major emission sources of metals in urban runoff are building materials and road traffic (Genc-Fuhrman, et al., 2006). In a study investigating sources of heavy metals in urban wastewater in Stockholm, Sörme & Lagerkvist (2002) found that car washes, which could represent vehicular contributions to stormwater during a precipitation event, were an important contributor of Pb, Cd, Cr and Zn to the urban wastewater (Sörme & Lagerkvist, 2002). Davis et al. (2001) showed that building siding is the largest source of Pb and Zn in urban runoff and the second largest of Cu and Cd. The reason for this is believed to be that the facade materials, e.g. the paint, contain and release metals. Further, high concentrations of Cu, Ni, Cr, Zn and Pb in stormwater have been traced to vehicle brake linings and Zn to tire wear (Genc-Fuhrman, et al., 2006). Atmospheric deposition has also been found to be an important contributor of Pb, Cu and Cd in stormwater (Davis, et al., 2001).

Metals are of particular interest in stormwater runoff due to their omnipresence, and the fact that metals cannot be chemically transformed or destroyed (Davis, et al., 2001). They have a tendency to accumulate in the body and food chain and are therefore considered a health threat (Ahlman, 2006). Metals can have negative impact on both human health and aquatic environments including both acute and chronic effects, such as being carcinogenic and causing reproductive damages (Davis, et al., 2001; Fuhrman, et al., 2006). Many aquatic organisms can bioconcentrate metals, e.g. oysters and

mussels can contain levels of Cd up to 100,000 times greater than the concentration in the surrounding water (Baird & Cann, 2008).

Several studies on sorption of metals in column filters have been made, for example by Kalmykova et al. (2008b & 2009b) and Färm (2002). But the authors have not been able to find studies that simultaneously investigate removal of metals and organic pollutants on natural stormwater. The studies investigating removal of both metals and organic pollutants that were consulted in this thesis have either been performed on landfill leachate or with synthetic stormwater.

## 2.2 Sorption

The process of adsorption can be defined as the accumulation of a substance, an adsorbate, on the surface of a solid, the adsorbent (Chowdhury, et al., 2012). In water treatment the process usually occurs at an interface between a solid adsorbent, a filter material, and the contaminated water (Ali, et al., 2012). If the properties of the water changes, e.g. pH, concentration, temperature, the process can reverse and the adsorbate will be released from the adsorbent, this is called desorption (Worch, 2012). Figure 1 shows a simplified description of the basic terms used to describe adsorption. Absorption, on the other hand, is the transfer of a substance from one bulk phase to another bulk phase. The substance is enriched not only on the surface but also within the receiving phase through minute pores or spaces between molecules (Gliński, et al., 2011). In some natural systems, materials with complex structure can bind substances both on their surfaces and in the interior of the materials (Worch, 2012). It can be difficult to make a distinction between absorption and adsorption in these cases. In natural systems, the more general term sorption is therefore used to describe these processes. In addition, the term also covers ion exchange processes on mineral surfaces. A more thorough description of the sorption processes can be found in, for example, the doctoral thesis of Anna Enell (2006).

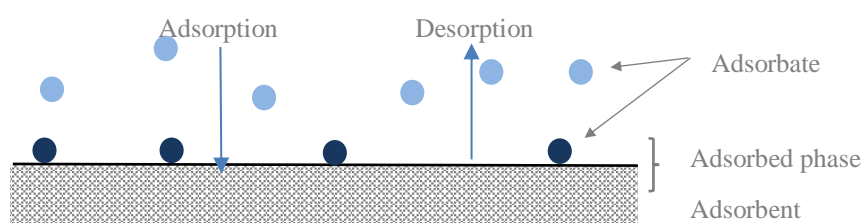

Figure 1. Basic terms regarding adsorption

Adsorption can be categorised as physical adsorption, physisorption, or chemical adsorption, chemisorption (Worch, 2012). Physical adsorption is characterised by nonspecific secondary bindings where electrons are being shared between the adsorbent and the adsorbate (Chowdhury, et al., 2012). These are called van der Waals forces and includes dipole-dipole interactions, dispersion and induction forces which are relatively weak bindings (Worch, 2012). Chemisorption is based on chemical reactions between the adsorbate and adsorbent and present a much stronger bond. The difference between chemisorption and physisorption is, however, arbitrary and the boundary between the two is fluid.

In the sorption of metals, the adsorbates are attracted to the adsorbent surface due to development of an electric charge on the surface (Kalmykova, 2009). To what degree the metal is attracted to the charged surface depends on the form it is present in the solution and its chemical properties. A free metal ion has a higher positive charge than a metal complex, hence the complex will have a reduced sorption to a negatively charged surface. The ionic potential, electronegativity and the electron configurations of a cation will also affect the rate of attraction between a metal and the adsorbent. The sorption of organic pollutants depends on the molecular weight and the water solubility of the compound (Ferhan & Özgür, 2011). In general, the adsorbability of a substance will increase with increasing molecular weight. A low water solubility means that the attractive forces between the compound and the adsorbent are stronger than the bonds between the compound and water, so the compound will be more likely to attach to the adsorbent. Other factors that can affect the adsorption either positively or negatively include the polarity of the adsorbent, the pH and temperature of the water and the composition of the solute.

### **2.2.1 Equilibrium and sorption isotherms**

As with most treatment processes, it is preferred to strive for optimal design and efficiency. In adsorption theory this is done by studying equilibrium data of the amounts of contaminant in the water versus the filter media (Allen, et al., 2004; Worch, 2012). Equilibrium refers to a balanced state between reaction processes, and in sorption systems equilibrium is reached when sorption and desorption occur at the same rate (Kalmykova, 2009). More specifically, no more uptake/exchange of contaminants occurs between the water and the filter. When equilibrium is reached, the adsorption reaction can be considered completed. In water, this process can be described as a function where the adsorbate (contaminant) is decreasing with time due to the uptake of the adsorbent (filter media) (Chowdhury, et al., 2012). The adsorbate is decreasing until no more uptake occurs and equilibrium is reached.

The equilibrium between the adsorbate and the adsorbent is often described by adsorption isotherms (Chowdhury, et al., 2012; Kalmykova, 2009). An isotherm is a graphical plot which describes the amount of solid-phase adsorbate ( $q$ ) to the amount of waterborne adsorbate ( $C$ ) at equilibrium (Figure 2). To plot an isotherm several equilibrium points need to be acquired experimentally. This is done by conducting experiments on the adsorbent where either the amount of adsorbent is changed, or the concentration of adsorbate in the water is changed.

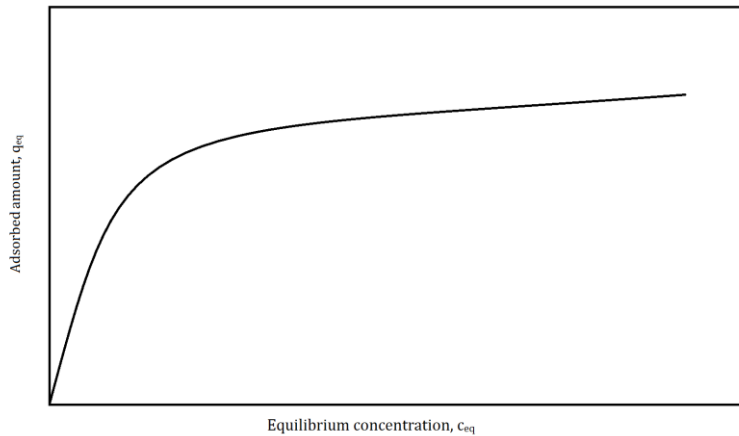

Figure 2. Adsorption isotherm

There are two adsorption isotherms equations that are most commonly used to describe adsorption; the Langmuir and Freundlich equations (Kalmykova, 2009). They are mathematical models which enable comparison of different filter media parameters. However, as one isotherm could fit experimental data perfectly, under one set of conditions, it might fail totally under other conditions (Allen, et al., 2004). So far, no single isotherm has been found to be generally representative for adsorption. Instead experimental data is fit with the isotherm models to see which one is most representative.

## 2.2.2 Sorption materials

Since adsorption occurs on the surface of a material, the surface area of the material is a key quality parameter of adsorbents (Worch, 2012). To achieve high surface area of a material, high porosity is a requirement, since this enables a large internal surface. In general, the larger the pore system and the finer the pores, the higher the internal surface. However, to enable the adsorbate to be transported to the adsorption site as fast as possible, a certain fraction of larger pores is necessary. For chemisorption, the surface chemistry may also be of interest. In the following section, the adsorbent chosen for the pilot plant are presented.

### Activated carbon

Adsorption with carbon has been used by humans in water treatment for millennia, but gained new strength in the early 20<sup>th</sup> century due to much higher efficiencies by activation of the carbon (Worch, 2012). There are two common variations of activated carbon, granular and powdered. The particle size of granular activated carbon (GAC) is about 0.5-4.0 mm and powdered activated carbon (PAC) is < 40  $\mu\text{m}$ . The most commonly used in water treatment today is GAC (Lenntech, u.d.). GAC have some advantages to PAC as it is possible to reactivate and reuse when the material is saturated. Used PAC must be deposited or incinerated. Fixed bed reactors uses GAC, while PAC is used as a slurry (Chowdhury, et al., 2012).

Activated carbon is regarded as the most efficient and is the most widely used adsorbent for removal of metals and organic pollutants such as pesticides, dyestuffs, phenols and PAHs from contaminated water (Aksu, 2005; Babel & Kurniawan, 2003; Ma & Zhu, 2006). Studies have shown that, for example, GAC placed in columns can have removal efficiencies for Cd and Pb of 99.98 % and 99.51 % respectively (Jusoh et. al, 2007).



Further, activated carbon have shown removal efficiencies for phthalates up to 80% (Mohan et. al, 2007).

Production of activated carbon is performed in two steps with an initial carbonisation of the raw material, followed by an activation of the carbonised material (Chowdhury, et al., 2012; Worch, 2012). The raw material used for carbonisation can vary, but some examples of common carbonaceous materials used are: wood, lignite coal, bituminous coal, coconut shells and peat. The choice of raw material will affect the activated carbons properties in pore structure, internal surfaces and surface chemistry. The carbonisation of the raw material is a pyrolytic process in the absence of oxygen. When the material is heated to 500 – 800 °C, volatile organic compounds are removed.

After carbonisation the material is activated (Chowdhury, et al., 2012; Worch, 2012). The activation refers to a process which increases the adsorption properties of the carbon. For activated carbon in water treatment, the most commonly used method is gas activation. It is a physical-thermal process where the carbonised material is introduced to an oxidising agent at temperatures of 800 – 1000 °C. The oxidising agent can be carbon dioxide, air or steam. During this process the activation gas reacts with the solid carbon to form another gaseous product. As parts of the solid carbon is “burnt off”, closed pores in the material open up and existing pores in the carbon are enlarged, thus increasing the internal surface area of the carbon. Important here is to not burn too much coal away, which could burn away open pores and decrease surface area. The optimal level of gas-activation must be found depending on material, but often about 40 – 50 % of the carbon is burnt away in the gas activation process. When the activation process is finished, the activated carbon can have an internal surface ranging from 500 – 1500 m<sup>2</sup>/g (Lenntech, u.d.). In water treatment an internal surface area of 800 – 1000 m<sup>2</sup>/g is often used. Pores should not be too small, to allow for larger molecules to enter the pore systems.

### **Peat**

Peat can be described as “coal in the making”, since it represents the first stage in coal formation (Brown, et al., 2000). Peat is a complex soil material containing organic matter in various stages of decomposition (Ahmaruzzaman, 2008). It is formed in areas with high moisture content where the rate of growth exceeds the rate of decomposition, the vegetation preserved by the water is very slowly oxidised to form peat. The composition of the final material is determined by factors such as regional climate, acidity of the water, degree of degradation and the type of vegetation present when the peat was formed (Brown, et al., 2000). Approximately 15 % of the Swedish land area is covered in a >30 cm thick peat layer and the most common variety in the south of Sweden is *Sphagnum* peat (Liljegren, u.d.). It is a highly porous material and raw peat contains mainly of lignin, cellulose, fulvic and humic acid, which can contribute to chemisorption since they contain polar functional groups (Ahmaruzzaman, 2008). Examples of these functional groups are carboxyl and hydroxyl which in contact with water will separate and convert to negatively charged areas. This enables dissolved solids, such as metals or polar organic molecules, to adsorb to the peat (Brown, et al., 2000). It is also the cellulose and lignin which are responsible for the sorption of non-polar hydrocarbons, such as PHCs on to peat (Kalmykova, 2009). Part of their molecules contain hydrocarbon chains and aromatic rings which attract the hydrocarbons by Van der Waals forces between the macromolecule’s hydrocarbon part and the PHC chain. Further, lignin and cellulose are large molecules where PHCs

might be retained due to steric effects. These retained PHCs might contribute to the sorption capacity of the peat by forming large hydrophobic aggregates that further adsorb PHCs.

Peat is an inexpensive, plentiful and widely available material and have recently, because of high sorption capacities for several different contaminants, been promoted as an adsorbent (Ali, et al., 2012). The majority of the studies performed on the removal efficiency of peat filters have intended to investigate the maximum adsorption capacity of the material, so artificial wastewater or stormwater have been used (Kalmykova, 2009). The studies performed, either as batch tests or packed column studies, have shown that sorption is highly dependent on the peat origin, degree of decomposition, particle size, pollutants and ligand concentration as well as competing ions. However, several studies have shown peat to have a widespread capacity to remove metals, oils, pesticides, detergents, dyes, phosphorus and nitrogen (Krewer & Moona, 2012).

Peat cannot be reactivated in the same way as coal, but the adsorbates can be released from the adsorbent through desorption. If desorption is successful, valuable substances that have been collected in the filter material may be recovered (Worch, 2012). Studies on recovery of metals from biomass adsorbents have resulted in different levels of success (Gupta, et al., 2009). It has, however, been shown that adsorbed metals can be removed completely from the peat filter using various acids or deionised water (Gupta, et al., 2009; Gardea-Torresdey, et al., 1996). Varying amounts of desorption liquid and contact times have been required.

*Sphagnum* peat is mainly made up by *Sphagnum* moss, which is formed when the bog has little access to nutrients, and is often poorly decomposed (SGU, u.d.). Most of the *Sphagnum* peat in Sweden have been created during the last 5000 years (Liljegren, u.d.). This type of peat has shown to be efficient for adsorption of metals in water (Ringqvist, et al., 2002; Kalmykova, 2009). A study on the removal of PHCs, PAHs, alkylphenols, bisphenol A and phthalates from landfill leachate by sorption to sphagnum peat filters by Kalmykova et al (2014) showed that peat filters had a removal efficiency for PHCs at 35% and for PAHs at 63%. Further it was shown that oxy-PAH were efficiently removed in the peat filters.

### **Pine bark**

Bark is defined as the external layer of a tree stem, amounting to approximately 10 – 15 % of the total weight of the tree (Sjöström, 1993). Bark can be divided in two layers, inner and outer bark. The inner bark is alive, the main function for the cells are to transport and store liquid and nutrients and to work as support tissue (fibres). The outer bark is dead and mainly consists of cork layers. The function of the cork layers are to protect the wood tissue from damage as well as temperature and humidity variations.

The chemical composition of bark is complicated and varies substantially between different types of trees, but it can generally be divided in to fibres, cork cells and fine substances (Sjöström, 1993). The fibre fraction contains mainly cellulose, hemicellulos and lignin while cork cells and fine substances consist of large amounts of extractives. The total content of lipophilic and hydrophilic extractives in bark usually makes up around 20 – 40 % of the dry weight. This fraction mainly consists of fats, waxes, terpenoids, aliphatic alcohol and phenolic constituents, such as condensed tannins. The walls of the cork cell are impregnated with suberin, which is very similar to lignin but

contains hydrophobic acids, and the main part of the polyphenols are concentrated in the fine fraction. The difference in the chemical composition between the inner and the outer bark lies in the contents of the different substances (Fengel & Wegener, 1983). In general, the content of extractives and cellulose is high in the inner bark and the contents of lignin and polyphenolic substances (e.g. tannins) are higher in the outer bark.

The interest for using waste materials from the forest industry as sorbents for treatment of contaminated water have increased in recent years (Sud, et al., 2008). Bark, a waste product from the timber industry, is abundant and highly available which has made it a popular adsorbent (Ahmaruzzaman, 2008). It is also a cheap alternative for sorption treatment since, in general, the cost of forest wastes is associated with cost of transport from the storage to the site where it will be used (Palma, et al., 2003). Bark have been found effective for removing phenols from water solutions (Ahmaruzzaman, 2008), and to has a high sorption capacity towards metals in water solutions (Nehrenheim & Gustafsson, 2008).

The sorbtive properties of the bark for both organic pollutants and metals are explained by the high content of tannins (Ali, et al., 2012; Kalmykova, 2009). The poly-hydroxyl group in tannins are the active species in the adsorption process of bark (Ali, et al., 2012). The main problem with using bark for sorption is discoloration of the water since soluble phenols and organic acids, such as cellulose and lignin, are produced during bacterial decomposition of the bark polymers (Ali, et al., 2012; Genc-Fuhrman, et al., 2006).

A study performed by Björklund and Li (2015) on the sorption properties of a few low-cost materials for sorption of hydrophobic organic pollutants (HOC), such as PAHs, phthalates and alkylphenols, using synthetic stormwater showed that pine bark can be efficient for sorbing PAHs . Further the results showed that the sorption capacity of pine bark that was previously untreated and pine bark that was heat treated before the test were very similar.

## **2.3 Filtration**

In general water treatment, filtration is one of the principal methods used to remove specific constituents from water. Filtration is typically used to remove residual organic and inorganic colloidal and suspended solids (Metcalf & Eddy, 2004). In advanced wastewater treatment additional filtration methods such as sorption are implemented to target suspended, colloidal and dissolved constituents that remain after conventional treatment. The dissolved content includes a continuously increasing numbers of complex synthetic organic compounds.

### **2.3.1 Gravity filtration using granular media**

Gravity filtration using a granular-media is the most common filtration method due to its simple design where water is allowed to flow through a filter media by gravity (Chalmers WET, 2014). In a conventional granular filter design, the filter media is typically sand on top of a supporting layer of gravel (Metcalf & Eddy, 2004). In drinking water treatment, the sand bed is usually about 60 cm deep and the graded layer of gravel acts as an underdrain. The water level on top of the filter medium builds up pressure head and is usually 90 – 120 cm. During filtration, water passes through the

filter by the pressure head and from suction from the underdrain. The filter can be cleaned by backwashing, thus reversing the flow by pumping it upwards through the granular filter media. Figure 3 shows a conceptual figure of filtration and backwashing.

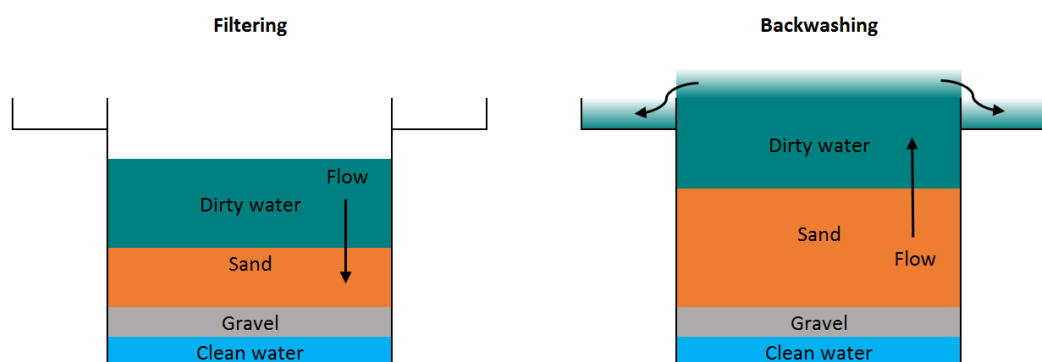

Figure 3. Schematic figure describing a) filtration and b) backwashing with expansion of sand media. Figure adapted from Rensselaer Polytechnic Institute, (n.d.)

In traditional gravity filters the rate of filtration is regulated by controlling the outflow from the filter underdrain (Chalmers WET, 2014). The inflow to the filter is controlled either automatically or manually to equalize the outflow and thereby maintaining a constant water level above the filter bed.

The behaviour of the granular filter during operation mostly depends on the grain size of the material (Metcalf & Eddy, 2004). Head loss through the filter is affected by build-up and accumulation of particles in the pores of the granular media. Factors determining the lifetime of a filter are the head loss or when the pollutants concentration in the filtered water reaches unacceptable levels, referred to as breakthrough. Under ideal operating conditions, head loss and pollutant levels correlate and reach limiting values at the same rate. This is however very difficult to obtain in reality due to changing conditions and quality of influent water. The backwashing cycle depends on which one of the factors that first reaches its limiting values.

### 2.3.2 Backwashing

At the end of a filter run, either by breakthrough or head loss, backwashing of the granular media filter is required (Chalmers WET, 2014). Backwash is performed by reversing the flow through the filter, thus pumping water upwards through the filter media. This action removes or flushes away suspended matter caught in the filters by the shear forces created by the backwashing pressure. During backwashing the filter bed expands 15-30 %, sometimes even up to 50 % of its operational height (Rensselaer Polytechnic Institute, u.d.).

The graded gravel underdrain plays a major role in successful backwashing (Chalmers WET, 2014). The grading is built up by gravel fractions in the range of 20 – 2 mm. Coarser gravel (20 – 3 mm), is placed at the bottom to disperse the wash water flow and finer gravel (3 – 0.2 mm) is placed on top to serve as a barrier to prevent intermixing with the granular filter media. Backwash rate is usually about 10 L/m<sup>2</sup>\*s for approximately 3 – 10 minutes (Rensselaer Polytechnic Institute, u.d.), while the volume of water used for backwashing is about 2 – 4 % of the filtered volume of water.

When backwashing sandfilters, problems may arise in poor filter cleaning (Chalmers WET, 2014). Some pollutants or heavy impurities may drop down to the gravel underlay during backwashing instead of being washed away. Solving this by higher backwashing rates could lead to carryover of sand or disturbances in the graded gravel underdrain. In modern filters these problems are often resolved by installing washing aids such as mechanical arm agitators or nozzles that spray water into the expanded filter bed.

### **2.3.3 Ideal filter media**

The ideal filter material should be coarse enough to ensure sufficient pore openings to contain particles, but fine enough to prevent passage of suspended solids (Chalmers WET, 2014; Metcalf & Eddy, 2004). Finer filters suffer from problems with high frictional resistance and head loss. Adequate filter depth is also of importance to allow longer filter lifetime before saturation. The filter bed should also be graded enough to permit effective backwashing.

In previous filters used for water treatment nearly uniform sand was used (Chalmers WET, 2014). When backwashed, these sandfilters became hydraulically graded with the largest grains at the bottom and the finest grains on top. This creates a bed where almost all filtration occurs at the top fine sand layer of the filter, thus not making use of the available filter bed depth. Modifications to solve this single-medium problem was using dual-media beds, where coarser anthracite was placed on top of the sand to provide an upper layer with increased porosity.

### **2.3.4 Sorption – design aspects**

Design of adsorption filters is related to the particle size of the adsorbent (Worch, 2012). For activated carbon, both powdered and granular versions are highly efficient. In general, slurry reactors are used for PAC and fixed bed reactors for GAC. PAC has higher adsorption rates than GAC, thus reaches equilibrium faster, but cannot be used in a fixed bed reactor due to high flow resistance which increases with smaller particles. Using granular sorbents in a fixed reactor requires no additional separation step. It does however have a slower sorption process due to the larger particle sizes. GAC can also rather easy be regenerated, by oxidising the organic matter, and reactivated with small losses of carbon during the process, while powdered media has to be incinerated or deposited.

Equilibrium between the rate of sorption and desorption in the filter may not be reached within the provided contact time (Worch, 2012). The rate of sorption depends on particle size, type of adsorbent, properties of adsorbent and process conditions. Columns with GAC are usually designed for gravity filtration. The sorption efficiency of activated carbon depends on temperature and nature of contaminants in the water. The filter needs to be replaced periodically.

As previously mentioned, the sorption capacity can be positively or negatively affected by the composition of the solute. This is because several adsorbates may be competing for the available adsorption sites on the adsorbent surface (Worch, 2012). Since the composition of stormwater can vary substantially, it is possible that the runoff will contain elements that disrupts the sorption of the desired pollutants. The influence of

Fe-ions on sorption of other metals has been investigated by Kalmykova et al. (2008). The study showed that Fe has a negative impact on the sorption of Cd, Ni, Zn, Cu and Pb and leads to quicker breakthrough of Cd, Ni and Zn. It is possible that other major elements, such as Al and Mn, could have the same disruption effect on sorption efficiency as Fe.

Another factor that may affect the sorption efficiency is pH. A study on the sorption capacity of bark on Cd and Hg performed by Vázquez, et al. (2002) showed that the sorption increased with pH at a rate of 0.06 – 0.08 mmol per pH unit. Similarly, Kalmykova et al. (2008a) found that the uptake on Cd, Cu, Ni, Pb and Zn on *Sphagnum* peat is higher at pH 5.6 than at pH 4. This may be a disadvantage in peat filters since peat buffers contaminated water to around pH 4 (Kalmykova, et al., 2008b).

### 3 Case Study

In this chapter the location of the pilot plant in the Järnbrott area is described. The information covers the catchment area for the incoming stormwater as well as the current ponds used for stormwater treatment at the Järnbrott junction.

#### 3.1 Järnbrott area

The Järnbrott junction is a large intersection of the two roads Söderleden and Dag Hammarskjöldsleden. The area is located a few kilometres south of the Gothenburg city centre and the area is heavily trafficked. At this intersection, all stormwater from the catchment area in Figure 4 is collected, led under the road and discharged into the river Stora ån, where it eventually ends up in the sea, at the recipient location Välen bay (Göteborg Stad, 2015). Both receiving water, Stora ån and Välen bay, are classified as highly sensitive for contamination due to their high ecological and recreational values. The majority of the catchment area is also classified as heavily loaded with pollutants, due to heavy traffic, and is estimated to require comprehensive treatment before reaching the Välen bay. The total stormwater catchment area approximates 425 – 475 ha, where about 40 % is impervious surfaces and includes a mixture of roads, industrial, commercial, housing and green areas (Figure 4).

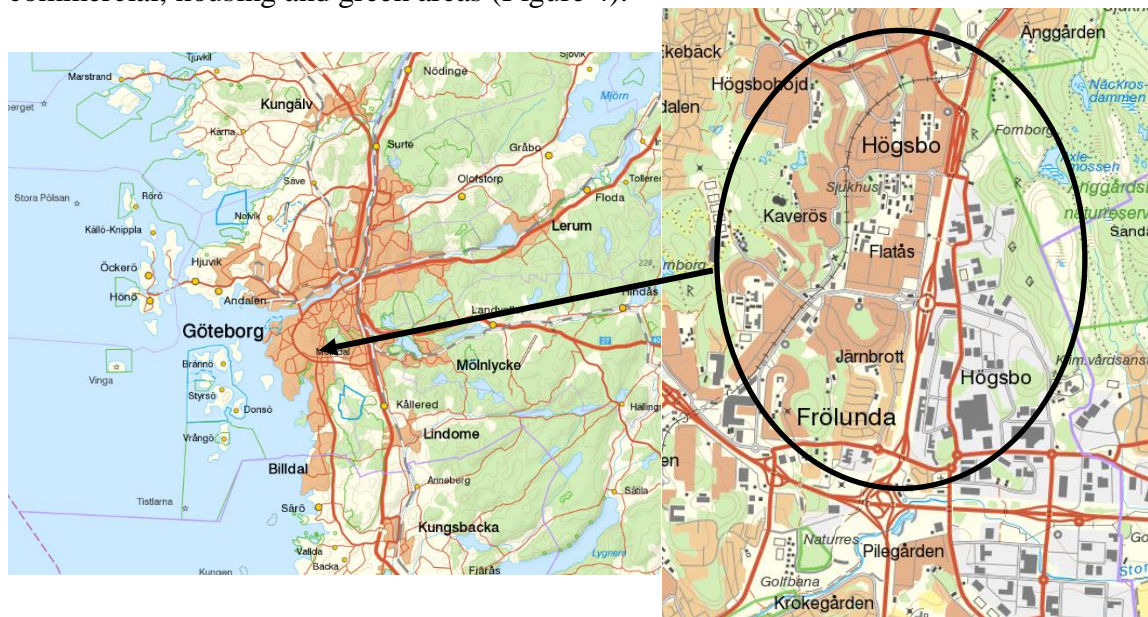

Figure 4. The Järnbrott catchment area (right) and location (left) in Gothenburg, map from Lantmäteriet (2016).

#### 3.2 Järnbrott stormwater ponds

In the mid 1990's two stormwater ponds were constructed at the Järnbrott junction with the purpose of stormwater pollutant reduction (Pettersson, 1999). One small pond was constructed as an experimental pond for studies on performance and pollutant removal efficiencies and one larger pond was constructed solely for remediation of stormwater. Both ponds are off-stream ponds, which means no significant continuous base flow occurs between rain events.

Studies on the pond treatment capacity have shown that the removal efficiency is high, but not satisfying (Göteborg Stad, 2015). The treatment in the pond is based on retaining stormwater long enough to enable particles to settle. In the outflow high pollutant loads of toxic metals and carcinogenic substances have been detected which could indicate the removal efficiency is insufficient.

The smaller pond is located on the north-east side of the junction and has a surface area of 530 m<sup>2</sup> and a pond volume of 500 m<sup>3</sup> at dry weather conditions (Pettersson, 1999). It was constructed in 1993 and the total catchment area is 4.2 ha, whereof 2.6 ha are impervious surfaces. An inlet concrete pipe (Ø 400 mm) supplies this pond with water from the catchment area. The outlet consists of a weir and following the pond, water is directly discharged into the stream Stora ån. The pilot plant is placed next to this pond, but water from the small pond will not be used in the pilot plant.

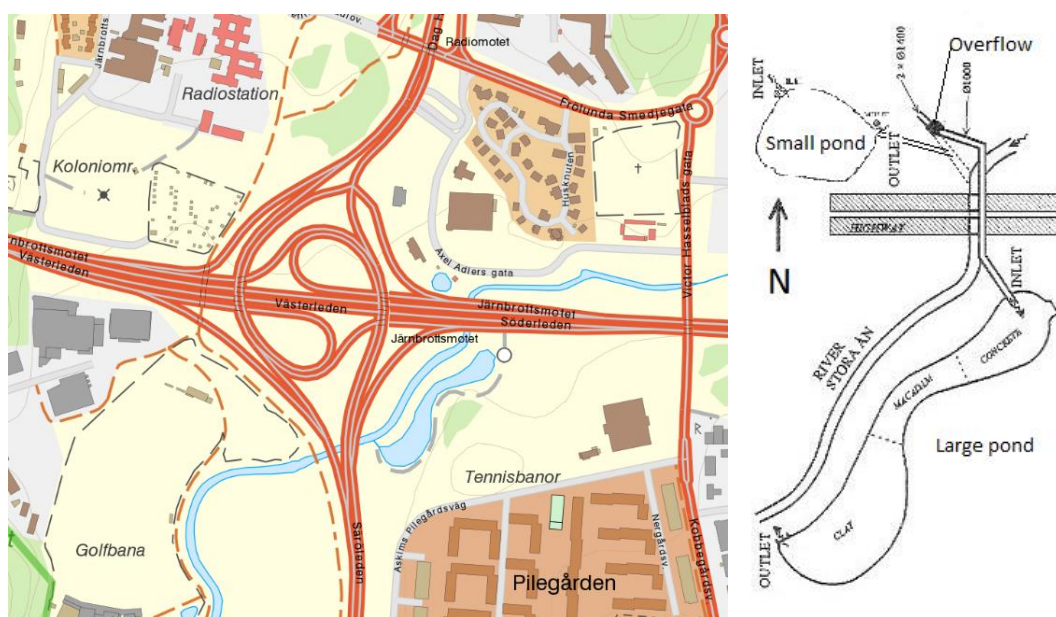

Figure 5. Left: Järnbrott junction and ponds (Lantmäteriet, 2016). Right: Conceptual figure of Järnbrott ponds (Pettersson, 1999)

The larger Järnbrott pond is located on the south-east side of the junction. It was constructed in 1996 and has a surface area of 6200 m<sup>2</sup> and a pond volume of 6000 m<sup>3</sup> at dry weather conditions (Pettersson, 1999). The catchment area of the large pond is approximately 480 ha, whereof 160 ha are impervious surfaces. The inlet consists of a 1000 mm steel tube originating from an overflow located next to the small pond. Into the overflow chamber, two 1400 mm concrete pipes supplies stormwater from the catchment area. From this overflow chamber (Figure 5), water will be withdrawn for treatment in the pilot plant and later discharged into the stream Stora Ån.

When the flow into the overflow weir is less than 700 l/s, all stormwater is led into the large pond (Pettersson, 1999). If the flow exceeds 700 l/s, excess water is directly discharged through the overflow into Stora Ån. The total maximum inflow to the overflow is about 8 m<sup>3</sup>/s. About 80 % of the annual stormwater volume flows through the pond before reaching the river.



Previous studies on the Järnbrott stormwater ponds have found that several different pollutants are present in the ponds. A study by Strömvall et al. (2007) found high concentrations of several organic contaminants including alkyl-benzenes, aliphatics, 4-nonylphenols, total of mono- and di-nonylphenol etoxylates, PAHs, DEHP, and several brominated flame retardants in sediments from the pond. Wik et al. (2008) also found aliphatics and PAHs in sediments from the pond in concentrations regarded as very serious by the Swedish environmental criteria for contaminated sites. Several studies has recorded high concentrations of metals in the pond water and sediment, including Cd, Cu, Pb, Zn, Cr, Ni, As and Hg (Lavieille, 2005; Wik, et al., 2008; German & Svensson, 2005). Several of these metals were found in levels exceeding Canadian and Swedish environmental guidelines.

## 4 Method

Three different materials have been chosen for testing in the pilot plant; (1) *ScanPeat Blocktorv*, a *Sphagnum* peat from the south west of Sweden, (2) *Zugol* granulated pine bark, a Swedish product used as an adsorbent of oil spills pine bark and (3) *Calgon Carbon Filtrasorb 400*, a granular activated carbon. More information about the materials can be found in Appendix I. The following sections describes the method used for the characterisation of these materials and design aspects of the pilot plant.

### 4.1 Material characterisation

To evaluate the performance of the chosen filter media, materials are characterised by analysing hydraulic loading rate, as well as physical and chemical properties.

#### 4.1.1 Hydraulic loading rate

The desired flow through the filters in the pilot plant was set to 2 L/min. To test whether this flow is obtainable through the peat and the bark, laboratory testing of the hydraulic loading rate was performed. The flow through the materials was tested in 250 mL glass columns with an outlet at the bottom, Figure 6. Required minimum flow is determined by scaling down the real filter size in relation to bed height and width to equal the small glass columns, see Appendix II for calculations. The columns were initially packed with glass spheres and glass wool to allow free drainage at the bottom of the column. The maximum empty bed contact time was then tested in each column before loading them with filter media. All filter materials were saturated in water to determine how they behave in water, Figure 6.



Figure 6 Left: Glass columns used for laboratory testing of the hydraulic rate. Right: Peat and bark completely saturated in water.

In preparation of the column testing 150 mL dry peat was completely soaked and manually kneaded to remove air content and minimise floating of the material. The peat was then left soaked for 24 hours to fully saturate. Similarly, 150 mL of dry bark was completely soaked and thoroughly stirred, then left for 24 hours to fully saturate. After 24 hours the soaked filter media were continuously stirred while poured into the column. It was then allowed to settle for 1 hour. Hydraulic loading was applied using a siphon which allows a constant water level to be obtained in the column by the atmospheric pressure. The flow through the peat and bark were kept steady for 1 hour, while the out coming flow from the column was measured.

### **4.1.2 Physical and chemical properties**

For all filter materials the metal content, pH, organic matter and specific surface were tested. For peat and bark the bulk density, water content, and the cation-exchange capacity (CEC) were determined. The peat and bark were analysed both in its original state (non-sieved) and after sieving to a particle size close to the granule size of the GAC. For this project GAC sized 1.2 – 0.8 mm has been used. The activated carbon was sieved to verify the particle distribution using standard sieving sizes of 2mm – 1mm – 0.5 mm. Material for characterisation was sieved using a small stainless steel sieve which had to be manually shaken. The larger quantities of material used for the pilot plant was sieved using a larger automatically shaken stainless steel sieve, available at the Chalmers geology laboratory.

The bulk density of the materials was decided after oven drying in 105 °C for 12 hours. For organic matter and water content, methods 83-045, loss on ignition (LOI), and 83-034 were performed according to Sheldrick (1984). For pH and CEC methods by Bergil & Bydén (1995) were used. In the CEC-analysis, calcium was used as a saturation ion and the determination of the total concentration of calcium in the samples were determined by EDTA-titration and ion chromatograph. The analyses were performed on two samples each of peat, bark, GAC as well as of sieved peat and bark.

The metal content of the materials was determined with Inductively Coupled Plasma Mass Spectrometry (ICP-MS). The samples were microwave digested with nitric acid and hydrogen peroxide and diluted (0.1 mL sample to 9.9 mL deionised water). For the ICP-MS analysis, three samples each of the peat, bark, GAC and the sieved peat and bark were analysed.

For all three materials, the surface area was determined with a BET-analysis using liquid nitrogen as a saturator in a Micromeritics Tristar instrument. The analysis was performed by the Chalmers Department of Chemistry. For peat and bark sieved fractions of 0.5 – 2.0 mm were analysed, while GAC was analysed directly. The method used did not allow for a representative analysis of the original material because of the larger particle sizes of the peat and bark.

## **4.2 Pilot plant**

This research project, for which this pilot plant is constructed, aims at analysing removal efficiencies of colloidal and dissolved pollutants in sorption filters. Particulate matter and particulate bound pollutants should therefore be removed from the water before reaching the filter media. As it was not practically possible to place the pilot plant after the sedimentation pond in Järnbrott, a sandfilter preceding the sorption filters is used to simulate pond removal of particulate matter.

### **4.2.1 Design and implementation**

The container carrying the columns was obtained from a previous project where it had been used to treat landfill leachate. The columns had been used as sand and activated carbon filters. The activated carbon and the sand were drained from the columns and the remaining coarser bottom beds were soaked in a 20 % methanol solution for 1 week.

In total four columns are used: sand, GAC, peat and bark. The sandfilter precedes three parallel lines with GAC, peat and bark. The general design of the pilot plant is based on the idea of using gravitational flow through the filter columns. This method is chosen due to its simplicity in maintenance together with advantages in keeping constant water levels in the filter columns.

The height of the sorption filter beds are designed using GAC as a reference material. Input parameters are the desired flow together with the required filter contact time. The flow is set to 2 L/min in each filter column with contact time 20 min. The filter height ( $h$ ) is then calculated using the empty bed contact time (EBCT) in equation (1) (Metcalf & Eddy, 2004). EBCT can be described as the total time the water is in contact with a given bed volume.

$$EBCT = \frac{V}{Q} = \frac{A \cdot h}{Q} \quad (1)$$

Where

$EBCT$  is the Empty bed contact time [h]

$V$  is the volume of the bed [ $m^3$ ]

$Q$  is the flow through the bed [ $m^3/h$ ]

$A$  is the base area of the column [ $m^2$ ]

$h$  is the height of the bed [m]

Before the adsorption materials were packed in the columns the peat, bark and carbon were soaked in water for a minimum of 24 hours. The peat was processed manually, similarly to how it was treated in the laboratory testing of the hydraulic loading rates. The filter materials were then poured into the columns and allowed to settle for approximately one week.

Data on the flow through the columns was collected during the start-up phase of the pilot plant in order to evaluate plant performance. This data was logged in the pilot plant operation journal between the dates 2016-05-10 and 2016-05-20. Complete journal notes can be found in Appendix IV.

## 4.2.2 Sampling

Sampling points are implemented before the sandfilter (raw water), after the sandfilter and after GAC, peat and bark filters respectively, see Table 1. In total five sampling points cover all changes in water quality through the pilot plant.

Table 1. Sampling points in the pilot plant.

Sampling point	
1.	Before sandfilter
2.	After sandfilter
3.	After GAC filter
4.	After peat filter
5.	After bark filter

In the start-up phase of the pilot plant grab samples from each sampling point were collected for analysis. The initial reference sample was collected after a long dry period without runoff events. The water passing through the pilot plant at this time is therefore believed to consist mostly of groundwater infiltrating the stormwater pipe network in the catchment area. It was planned to take another grab sample after a storm event to get an initial assessment of the capacity of the filters. Due to a very long period without rain at the end of the project, this second sample was not collected. Later in the project, continuous time-proportional samples will be collected from the pilot plant. These samples will be collected at each sampling point with peristaltic pumping at 60 mL/h into 10 L glass bottles placed on the floor of the pilot plant.

For the reference sampling, 2 L of water was collected from each sampling point. For all the samples the following general parameters were determined: Total organic carbon (TOC), dissolved organic carbon (DOC), total suspended solids (TSS), pH, conductivity, major cations and anions and redox potential. Further, the content of aliphatic (C<sub>8</sub> – C<sub>35</sub>) and aromatic (C<sub>8</sub> – C<sub>35</sub>) hydrocarbons, PAHs, phthalates and metals (Cu, Zn, Pb, Cd, Cr and Ni) was analysed. Some major elements (Fe, Al and Mn) was also analysed to investigate their potential effect on the sorption of pollutants in the filters. The general water quality parameters were analysed at the Chalmers Environmental Chemistry laboratory. The analysis of the OPs and the total and dissolved metal content were performed at a commercial laboratory. Later in the project, oxy-PAHs, alkylphenols, polychlorinated biphenyls (PCBs), phthalates and bisphenol-A will occasionally be analysed at each sampling point.

Temperature, conductivity, pH and redox potential were analysed directly on-site using a calibrated WTM multi 350i sensor with required probes. For the metal content water was collected in acid-washed plastic bottles and transported to Chalmers laboratory where analysis was performed using ICP-MS analysis. TOC, DOC and TSS were analysed in the Chalmers laboratory according to Swedish standards SS-EN 1484. For the TSS-analysis filter paper with a size of 1 – 2 µm was used. Determination of dissolved ions in the water was analysed using an Ion Chromatograph (IC) according to SS-EN ISO 10301-1. For these analyses water was collected in plastic bottles and transported to Chalmers laboratory.

In this report only the results from analyses of the general parameter from the grab samples will be presented. Results for OPs and the metals was not delivered in the time span of this thesis and are therefore not presented. These results can be found in Appendix VII.

## 5 Results and Discussion

In this section results are presented in the following order; material characterisation, pilot plant design, pilot plant operation and removal efficiency. Results are continuously discussed as they are presented.

### 5.1 Material characterisation

To minimise uncertainties, most of the analysis have been carried out as duplicate or triplicate samples, however, the results will be presented as a mean of the tested samples. Full results can be found in Appendix III.

#### Laboratory testing of hydraulic loading rate

Hydraulic loading rates determined in the laboratory test gives a hypothetical maximum flow in the pilot plant of 3.2 L/min for the peat and 26 L/min for the bark, calculations can be found in Appendix II. Other studies have found that a typical hydraulic loading rate of GAC in columns is between 7 and 10 m/h (Reed et al., 1996). For our pilot plant this would give a flow through the columns between 8 and 12 L/min, meaning that that the peat filters can be expected to have the lowest flow in the plant and bark filter the highest. During the initial laboratory testing it was found that fractions of the bark were floating and had to be skimmed off if not settled when a hydraulic load was applied on the media. It was however found that all the bark did settle when given enough time to soak. All of the peat tended to settle when a hydraulic load was applied to the media. Air bubbles formed in the peat during the test caused the top of the filter bed to lift and float when the hydraulic pressure was released.

#### Physical and chemical properties

The majority of the activated carbon granules were between 0.5 and 2 mm (97 %), see Table 2 for the grain size distribution of the sorption materials. To increase the comparability between the three columns the peat and the bark were sieved and particles between 0.5 – 2 mm were used for the sorption filters. The 0.5 – 2 mm fraction of the peat and bark makes up 33 % and 50 % of the total weigh, respectively. This leaves 67 % of peat and 50 % of bark unused, which can be considered a disadvantage in the waste of material. The >2 mm, 2 – 1 mm and 1 – 0.5 mm fractions of the peat and bark can be seen in Figure 7.

Table 2. Grain size distribution of the sorption materials.

Sieve size [mm]	Peat (48.8 gram)	Bark (49 gram)	GAC (162 gram)
> 2.0	28 g (58 %)	17 g (34 %)	0 g (0 %)
1.0 – 2.0	8.9 g (18 %)	14 g (28 %)	115 g (71. %)
0.5 – 1.0	7.2 g (15 %)	11 g (22 %)	42 g (26 %)
< 0.5	4.6 g (9 %)	7.7 g (16 %)	5.0 g (3 %)

By removing the smallest particle sizes the risk of clogging is reduced. If the sorption filters would require backwashing, a uniform particle size is preferred to avoid unintentional grading of the backwashed material, where small particles tend to settle slower and might cause problems with clogging at the top of the filter. This could also lead to most of the sorption taking place at the top of the filter where the flow resistance would be higher.



Figure 7. The  $>2$  mm,  $0.5 - 2$  mm and  $<0.5$  mm fractions of the peat and the bark.

In Table 3, the results from the ICP-MS analysis of metal concentrations in the materials is presented in both sieved and original fractions. The results were compared with a previous study on similar peat and bark products performed by Kalmykova et al. (2007). The concentrations of metals exceeding expected results in the peat are Cu, Fe and Al, while the Ni, Zn, Al and Fe concentrations are high in the bark samples. The Cu content is 1000 – 2000 times higher than expected. For the sieved fraction of the peat, only one of the triplicate samples showed a high concentration of Cu, whereas the concentrations in the other samples was around 7 mg/kg. Since the high concentration of the third sample correlated with the concentration in the original peat material it was not removed from the results. The unexpectedly high values of Cu could possibly be explained by a natural random copper disturbance or remains from tools used in harvest and preparation of the peat. Another explanation could be an error in the analysis instrument or digestion procedure. Therefore it is necessary to run a second analysis of the metal concentration in the sorption materials to validate the results from this analysis.

Table 3. Metal concentration in the sorption materials.

ICP-MS [mg/kg]	Minor elements						Major elements		
	Cr	Ni	Cu	Zn	Cd	Pb	Al	Mn	Fe
Peat 0.5 – 2 mm	10	12	2400	32	3.9	8.2	27	2.9	83
Peat	3.2	10	7500	70	0.2	2.1	84	7.5	270
Bark 0.5 – 2 mm	3.4	30	4.6	260	0.1	0.1	330	670	7900
Bark	d.l <sup>a</sup>	5.0	1.2	n.d	0.1	n.d	12	63	870
GAC	5.9	12	18	39	0.1	7.6	660	13	2600
<b>Results from study by Kalmykova et al. (2007)</b>									
Peat	25	8.6	11	21	0.1	9.8	2.0	0.7	3.7
Bark	0.2	0.9	3.4	33	0.5	1.4	0.3	0.4	0.2

<sup>a</sup> Not detected

There are some notable differences between the metal concentration in the sieved fractions of the material and the original material. This is especially apparent in the bark where the concentration of Fe and Al is more than 9 and 20 times higher in the sieved samples, and likely dependent on natural variances in the concentration of the major elements in the materials. Chromium and Zn was not detected in the original bark material but were found in concentrations over 3 mg/kg and 250 mg/kg respectively in the sieved fraction. This difference was also observed for most trace metals in the peat but the differences between the sieved fraction and the original material was not as large. The higher concentration of metals in the sieved fraction is logical since the smaller fractions have a higher specific surface in relation to their mass, where the metals can attach (Jakobsson, 2003). This is also indicated by the higher cation exchange capacity in the sieved samples (Table 4). The sieves are made by stainless steel and should therefore not contain any copper that could leach to the material. The sieves could however leach Fe, Ni and Cr.

The remaining physical and chemical properties for the materials are presented in Table 4. The pH for the peat and bark is acidic, 2.6 for the peat and around 3.3 for the bark, and does not differ much between the sieved samples and the samples of the original material. The GAC however is basic with a pH of 10.9. The low pH of the bark and peat can be a disadvantage for the efficiency of the pilot plant since optimal sorption capacity for metals requires a higher pH (Chapter 2.3.4). However, stormwater transported in concrete pipes have showed to increase in pH and buffer capacity (Davies et al, 2010), and for this reason the low pH in the bark and the peat is not expected to affect the pH of the stormwater flowing through the filter material. All materials had a high organic content. The highest value was noted for the sieved fraction of the bark (99 %), and the lowest for the GAC (87%). In general, the bark had slightly higher organic content than the peat.

Table 4. Physical and chemical properties for the sorption filter media.

	pH	Loss on ignition [%]	Bulk density [%]	Water content [%]	CEC <sup>a</sup> [meq/100 g]	BET Surface area <sup>b</sup> [m <sup>2</sup> /gram]
<b>Peat 0.5 – 2 mm</b>	2.6	98	77	56	120	1.3
<b>Peat</b>	2.6	97	72	60	92	-
<b>Bark 0.5 – 2 mm</b>	3.2	99	140	33	63	0.2
<b>Bark</b>	3.4	99	110	37	70	-
<b>GAC</b>	11	87	-	-	-	780

<sup>a</sup> Cation-exchange capacity

<sup>b</sup> Brunauer – Emmett – Teller theory

The cation-exchange capacity (CEC) was performed on peat and bark. Peat showed higher capacity for the sieved fraction, 124 meq/100g, while bark showed a slightly lower capacity for the sieved fraction, 63 meq/100 g. The decrease in CEC in the sieved material could mean that the original material contains a larger fraction of the outer bark. Since the outer bark is likely to contain more tannins it can be expected to have a higher capacity for sorption, see Chapter 2.2.2. The levels of the CEC for the bark and the peat can be compared to the CEC for zeolite, a mineral often used for sorption of cations. The CEC for zeolites is normally in the range of 100 – 300 meq/100 g (Ming & Dixon, 1987). Compared to these values, the peat can be considered to have a high



CEC and be expected to sorb cations well. Since the sieved fraction of the peat has almost twice as high CEC as the bark, it is expected that the peat will have a higher capacity for sorption of metals.

For the CEC analysis, titration was initially used to determine the calcium content in extract. As the titration results were scattered, it was decided to run the sample extracts through the ion chromatograph, which gave more reliable results, see Table 4. The method used for determining the CEC was initially designed for analysis of soil and calcium was used as a saturation ion. Since calcium can form complex compounds with humic substances this might not be the optimal method for the peat and bark material used in this study (Bergil & Bydén, 1995). Other methods for determining the CEC for these materials could be researched in future studies for validation of the CEC in the bark and peat materials.

From the BET-analysis of surface area, GAC reached expected literature values of almost 800 m<sup>2</sup>/gram. Results for the sieved fraction of peat showed 1.3 m<sup>2</sup>/gram, while bark had a slightly lower value of 0.2 m<sup>2</sup>/gram. The surface area of the material is a key quality parameter of adsorbents and the high surface area of GAC is a large advantage in efficient adsorption. Therefore, this result indicates that the activated carbon should have a higher capacity for sorption than the peat and the bark.

## 5.2 Pilot plant

In this section results regarding the pilot plant are presented. The first part presents the final design of the pilot plant, followed by initial start-up data from the first operational days of the plant. Location of the pilot plant is in Järnbrott, Gothenburg which is closer described in Chapter 3.

### Final design

The pilot plant has been designed to be as maintenance-free as possible. The most suitable option for this is using self-regulating gravity filtration. By pumping the stormwater to an elevated level above the columns in the pilot plant, gravity flow can be used throughout the whole plant. The crucial part of the design is keeping a constant water level in the initial sandfilter. The water level in the sandfilter determines the water level in the following sorption columns by the force of gravity. This requires enough permeability through the sand to feed the following columns with sufficient volumes of water. As sandfilters are meant to capture particles and thereby will get clogged (Chapter 2.3), a regular backwashing cycle had to be dimensioned to ensure that enough water was allowed to pass through.

Options for keeping a constant water level in the sandfilter includes using digital sensors, set for a certain level, or letting the water level regulate itself by overflowing the sandfilter at a certain height. The latter option was decided to be the most suitable solution, as digital sensors would require programmed automatic control equipment, thus complicating the design. In Figure 8, a conceptual design of the pilot plant is presented. The figure shows the water pathway and hydraulics through the pilot plant together with location of the sampling points for water. The figure does not include the backwashing hydraulics for the filter columns. A complete flow chart together with a schematic layout showing locations of pipes and columns is available in Appendix V.

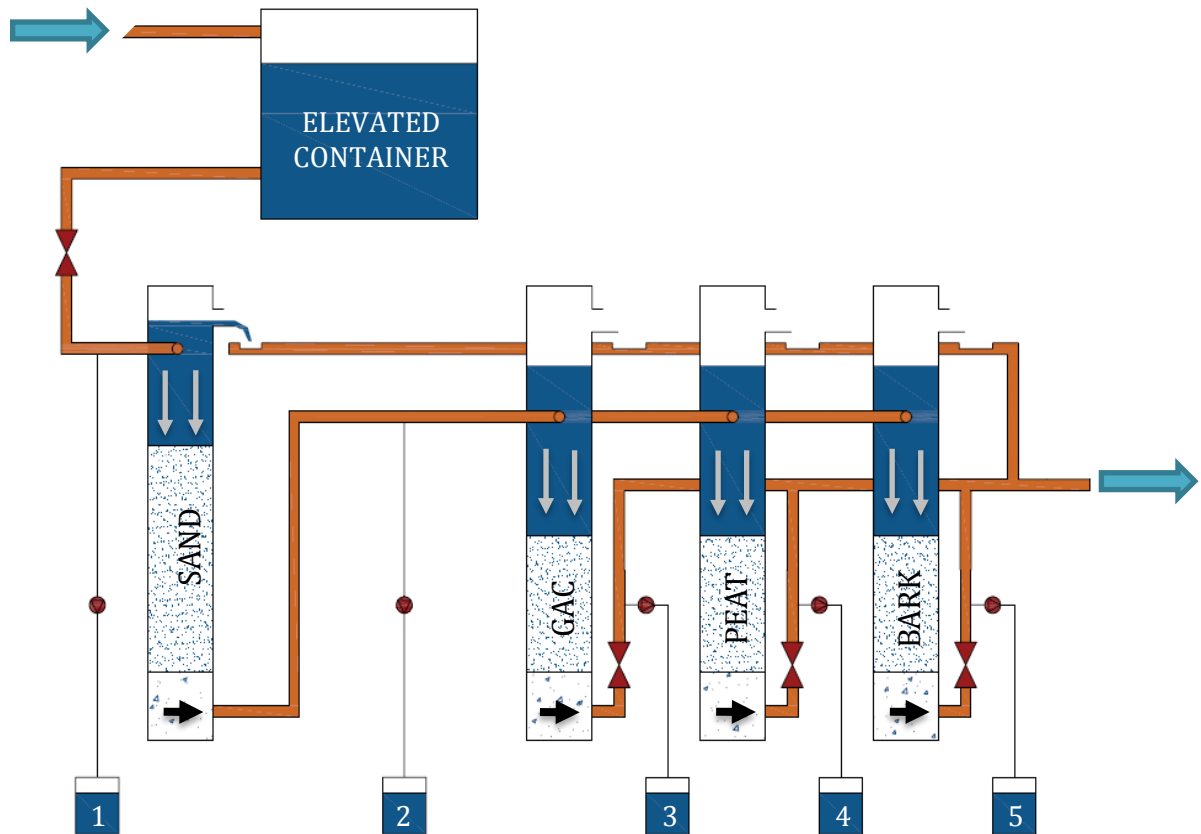

*Stormwater is pumped from the nearby overflow basin to an elevated container keeping the water level above roof height of the pilot plant.*

↓

*From the elevated container a continuous flow is led into the sandfilter. To keep the water level constant in the sandfilter, a constant overflow is allowed. Flow into the sandfilter can be regulated to reduce unnecessary high overflow.*

↓

*Three parallel sorption filters are gravitationally fed with water by the constant water level kept in the sandfilter.*

↓

*The sorption columns are possible to regulate to a desired flow by controlling the outlet valves.*

↓

*Outlet is placed above filter levels to never let them run dry in case of operational stop.*

↓

*Five sampling points with possibilities to connect peristaltic pumps are implemented before and after the sandfilter and after each sorption column.*

Figure 8. Conceptual design of the pilot plant.

## Columns

The columns are modified pipes produced in rigid PVC. As the PVC pipes were used in a previous project, no material specification was found. In the rigid form of PVC usually no plasticisers are added, and the column material should therefore not contain or leach any phthalates. Dimensions of the columns are: 2200 mm high, inner diameter 300 mm. In the bottom, all four columns are packed with a 450 mm drainage layer of graded gravel. The underdrain consists of 8 layers of gravel and sand, graded with finest material at top and coarser at bottom. On top of the drainage layer the filter media is placed. For the sandfilter a 300 mm bed height is used and for the sorption filters a bed height of 600 mm is used, see Figure 9.

### Granular media

- 0.6 – 0.8 mm (sandfilter column)
- 0.5 – 2.0 mm (GAC-, peat- and bark column)

### Graded gravel underdrain in all columns

- 0.8 – 1.2 mm
- 1.2 – 2.0 mm
- 2.0 – 3.0 mm
- 3.0 – 5.0 mm
- 5.0 – 10 mm
- 10 – 25 mm
- 16 – 32 mm
- 32 – 64 mm

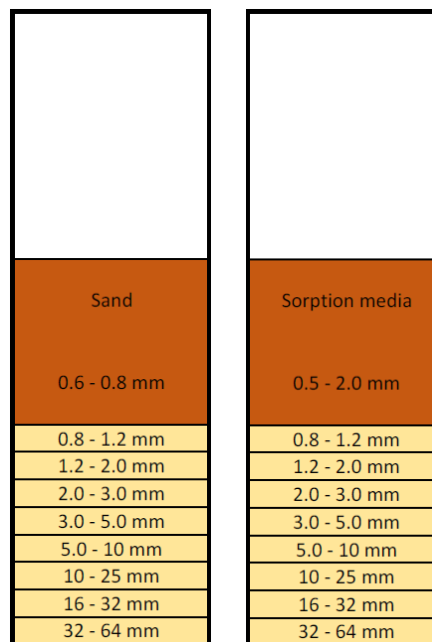

Figure 9. Left: Picture of the columns in the pilot plant.

Right: Conceptual design of the underdrain the sand and sorption filters

All four columns are designed to allow backwashing of the filter media. The sandfilter will be backwashed on a regular time-interval using a timer. The adsorption filters are

planned not to be backwashed during normal operating conditions, but are all designed to allow backwashing if problems would occur with head loss or clogging in the filters. Backwashing pressure is empirically determined to obtain a filter bed expansion of approximately 30 %.

### 5.2.1 Pilot plant initial operating results

Results presented in this section is based on the data logged in the pilot plant operation journal between the dates 2016-05-10 and 2016-05-20. Complete journal notes can be found in Appendix IV.

#### Pilot plant start up

The pilot plant was ready to start operating on the 10<sup>th</sup> of May, 2016. To determine an appropriate backwashing interval for the sandfilter, no automatic backwashing was initially scheduled. The three parallel filter columns (presented in consecutive order: GAC, peat, bark) were regulated to a flow of 2 L/min each while the overflow in the sandfilter was regulated to 2 – 3 L/min.

On the second day, no flow occurred through the GAC and peat column, while the bark had a flow of 0.5 L/min. The overflow in the sandfilter now reached almost 8 L/min, thus indicating almost full clogging of the sandfilter in approximately 43 hours. At this point (2016-05-12) the sandfilter was backwashed for the first time during operation, which resulted in a resetting of the flow to 1.6, 0.9 and 1.2 L/min in the GAC, peat and bark filter respectively. In Figure 10, a flow chart presents the flow data and the influence of the first backwashing of the sandfilter after 43 hours. After backwashing the sandfilter, the flow through the sorption columns did not return to the initial flow of 2 L/min. At this early stage of operating this was likely to be caused by the material slowly packing itself tighter due to the continuously downwards flow through the column.

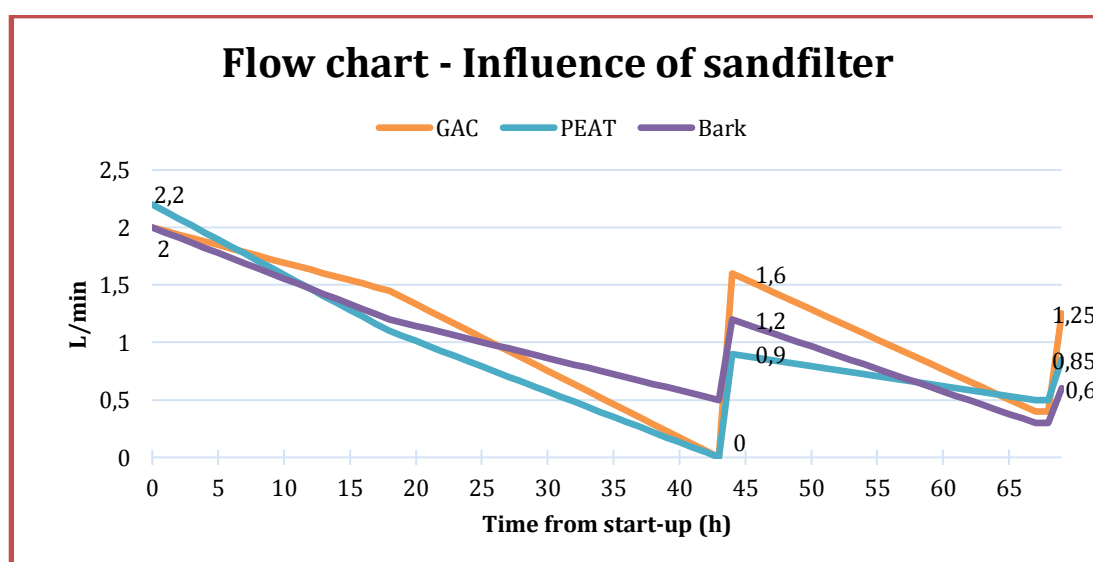

Figure 10. Flow chart of the data collected during the first 69 hours of operation. Manual backwashing of the sandfilter after 43 hours.

On the third operating day (2016-05-13), one day after the first backwashing of the sandfilter, the first grab sampling of water was carried out. The flow through the columns at this point was 0.4, 0.5 and 0.3 L/min respectively. The overflow in the

sandfilter was 7.6 L/min. After the first sampling, a second manual backwashing of the sandfilter was carried out, resulting in an increase in flow through the columns. The increase in flow was, however, smaller than the increase after the first backwash, see final flow after 69 hours in Figure 10. After the backwash, the outlet valve of the GAC was adjusted to allow a higher outflow, and the flow through the GAC filter was at that point 1.8 L/min.

Summarising the first days of operation, the clogging of the sandfilter during the initial 43 hours resulted in a loss of water pressure and pressure head large enough to stop the flow through the sorption filters. Based on this information it was decided to implement automatic backwashing of the sandfilter every 12 hours to avoid influencing the following sorption filters. The flow reduction through the sorption filter media despite backwashing of the sandfilter is presented in Table 5. At this point there was no sign of flow stabilisation through the sorption columns as the flow kept reducing. The continuous reduction of the flow through the columns could be caused by factors such as slow packing of the material or clogging by particles leached through the sandfilter.

Table 5. Flow reduction through the sorption filters during the first three days of operation.

	Initial flow [L/min]	After backwash 1 [L/min]	After backwash 2 [L/min]	Flow loss
<b>GAC</b>	2.2	1.6	1.25	43 %
<b>Peat</b>	2.0	1.2	0.85	58 %
<b>Bark</b>	2.0	0.9	0.6	70 %

### **Pilot plant steady operation with automatic backwashing of sandfilter**

This sections describes operational data of the pilot plant between the 4<sup>th</sup> and the 10<sup>th</sup> consecutive days since start up (May 13<sup>th</sup> – May 20<sup>th</sup>).

After the three first days of operation, automatic backwashing of the sandfilter was set to occur every 12 hours. This showed to be sufficient to keep the sandfilter from clogging and thus retain water levels and pressure head adequate in the sorption filters. However, since the water was considered to be comparably clean during this period, it might be necessary to backwash the sandfilter more frequently during runoff events when the water will contain more particles.

The flow chart of the sorption filter, presented in Figure 11, shows flow through the sorption filters over a period of 7 days, May 13<sup>th</sup> – May 20<sup>th</sup>. During this part of the operational period, focus was set on evaluating flow through sorption filters. Three days into the monitoring, flows through the GAC and bark columns decreased to about 0.3 L/min which was far below desired flow (2 L/min). It was then decided to backwash the GAC and bark filters, which can be seen by the renewed flow halfway into the flow chart in Figure 11. GAC was backwashed successfully, although some carbon particles with a very small grading were observed in the backwashing outlet flow, which could be expected according to a study performed by Clements and Haarhoff (2004). The study further states that this should not affect the GAC filter negatively as these fine particles have a small adsorption capacity in relation to the filter bed. Regarding the backwashing of bark, there was a risk of unintentional grading of the material, although no such effects could be observed. Backwashing flows were empirically determined to not risk any loss of sorption material and was set to 3000 L/h for GAC and 1000 L/h for bark.

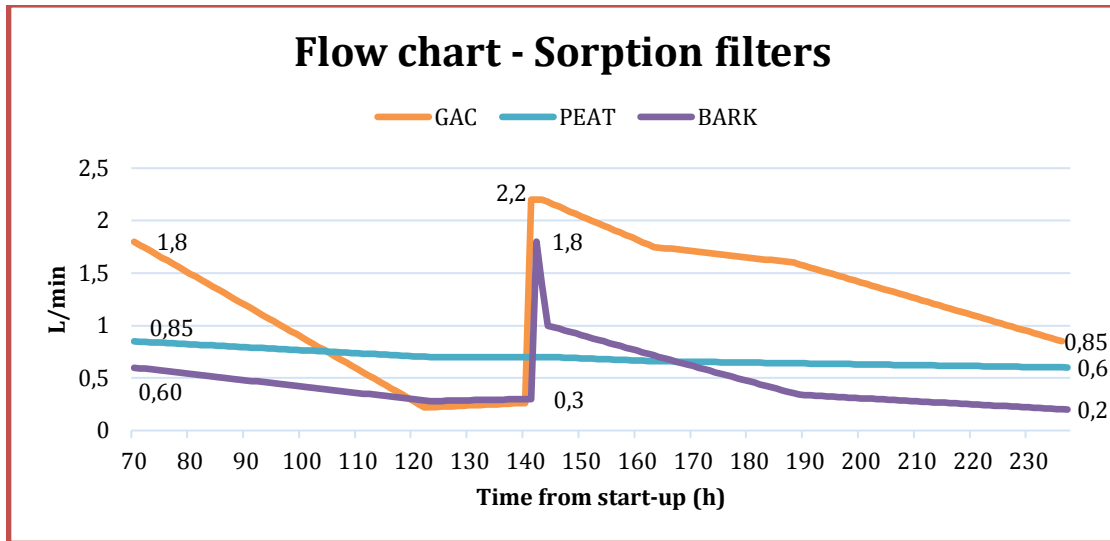

Figure 11. Flow chart of data between May 13th and 20th. Automatic backwashing of sandfilter in operation every 12 h..

The flow through the peat filter stabilised rather well during this period, and it was decided that this filter would not be backwashed. However, over this short time period no conclusion regarding a possible long-term stabilisation of the flow through the peat filter can be made. As the peat filter was still decreasing in flow at the end of the data collection, although slower and slower, it could still be subject of backwashing if decreasing too much.

Table 6. Reduction of flow between the start of the automatic backwashing of the sandfilter (May 13th), and the backwash of GAC and peat filters (May 16th).

	Initial flow, May 13 <sup>th</sup> [L/min]	Flow on May 16 <sup>th</sup> [L/min]	Flow loss over 3 days
<b>GAC</b>	1.8	0.3	83 %
<b>Peat</b>	0.8	0.7	13 %
<b>Bark</b>	0.6	0.3	50 %

The reduction of the flow in the sorption filters between the start of automatic backwashing of the sandfilter, and the backwash of the GAC and the bark, is shown in Table 6. The reduction of the flow in the sorption filters between the backwash and the end of the monitoring period is presented in Table 7. For both these measurements, the GAC and the bark both showed large losses in flow while the peat had a lower flow loss. This could indicate that the peat filter does not clog as fast as the GAC and the bark filters. It could also mean that the peat filter is not functioning properly and that channels have been formed through the peat, allowing the water to pass through the filter untreated.

Table 7. Reduction of flow in sorption filters between the backwash of GAC and peat (May 16<sup>th</sup>), and the end of the period (May 20<sup>th</sup>).

	Flow after backwashing GAC and bark. May 16 <sup>th</sup> [L/min]	Flow on May 20 <sup>th</sup> [L/min]	Flow loss over 4 days
<b>GAC</b>	2.2	0.85	61 %
<b>Peat</b>	0.7	0.6	14 %
<b>Bark</b>	1.8	0.2	89 %

During this 7 day period, the flow through the peat filter showed a rather stable behaviour, only decreasing with 0.2 L/min during the entire period. The more rapid decrease observed directly at start-up (Table 5) was probably caused by slow settling and packing of the peat material.

Flows through the GAC and the bark columns did not stabilise over the course of this period. After backwashing, the GAC showed a rather rapid initial decrease in flow followed by a longer period of linear decrease. The bark on the other hand had a slower initial decrease in flow before stabilising in a more linear reduction (see Figure 11 between 142 – 232 hours). A possible explanation for this is that the GAC settles rapidly after backwash, and the following linear decrease in flow represents the clogging of the filter, while the bark takes longer time to settle and compact to its original form before starting to clog.

Although the laboratory testing of the hydraulic load showed that a continuous flow of 2 L/min would be possible through the peat and bark filters, this flow has not been possible to maintain in any of the sorption columns. The reason for this is probably an error in the laboratory testing. One theory could be that the filter media in the glass columns had a much higher relative contact surface with the column walls than the larger columns in the pilot plant. This could then cause a higher impact of possible channelling along the columns walls in the glass columns. Another factor may be that tap water was used for the laboratory test. Tap water would contain no particulate matter that can clog the filter material.

### 5.2.2 Results of the initial water quality analysis

As previously mentioned, the pilot plant has been designed to firstly remove OPs, but also toxic metals. However, due to time constraints results from the analysis of the OPs and the metals were not obtained for this report. Therefore this section only covers analyses of general parameters of the stormwater.

The first water sampling from the operating pilot plant took place 2016-05-13. At this time the pilot plant had been operating steadily for three consecutive days, since 2016-05-10. The sandfilter was backwashed once during this period. Flow measurements and other pilot plant operating data from this period can be found in Appendix IV. To minimise uncertainties in the analysis, the TOC, DOC, metal, cation and anion analysis have been carried out as triplicate samples, however, the results will be presented as a mean of the tested samples. Full results can be found in Appendix VI.

The general parameters analysed in the water samples, before and after the filters, are presented in Table 8. Since peat is known to acidify contaminated water, pH was

expected to slightly decrease in the peat filter. As sorption of metals works better at a higher pH, this could affect the sorption negatively. However, the decrease in pH noted in both the peat, as well as the bark filters, was not considerable and should not affect sorption negatively in this case.

Table 8. General chemical parameters measured in the water samples before and after each column in the pilot plant.

	pH	Conductivity [ $\mu$ S/cm]	Redox [mV]	TSS [mg/L]	TOC [mg/L]	DOC [mg/L]
<b>1. Before sandfilter</b>	7.6	980	250	2.0	7.8	6.8
<b>2. After sandfilter</b>	7.6	630	220	0.4	6.5	6.0
<b>3. After GAC filter</b>	7.9	660	200	n.d <sup>a</sup>	1.3	1.6
<b>4. After peat filter</b>	7.4	660	210	0.3	7.1	7.2
<b>5. After bark filter</b>	7.4	650	200	2.4	10.3	9.8

<sup>a</sup> Not detected

The results from the TOC and DOC analysis showed that the sandfilter was removing some of the organic carbon, 17 % of the TOC and 12 % of the DOC. The GAC filter had the highest removal for organic carbon with efficiencies of 80 % for TOC and 73 % for DOC. The peat and the bark however, seemed to be leaching both TOC and DOC. The samples collected after the bark filters showed a higher concentration of both DOC and TOC than the untreated water. This is probably caused by leaching of soluble phenols and organic acids from the bark filter, a problem that has been documented in previous studies as well (Genc-Fuhrman, et al., 2006; Ali, et al., 2012; Bjöklund & Li, 2015). The sampling point after the peat filter had a higher TOC concentration than after the sandfilter, and a DOC concentration higher than the untreated water. Similarly to the bark, this can be explained by leaching of organic acids, the peat filter is likely to be releasing humic and fulvic acids in this early stage of operation (Kalmykova, 2008b). However, it is likely that the leaching of organic acids from the peat and the bark will decrease after the initial testing period.

In general, the sandfilter seems to be removing the bulk of the suspended solids (80%) in the water. This indicates that the sandfilter is working as planned, mostly passing dissolved and colloidal pollutants into the plant. The GAC filter removed all the remaining solids in the water while the peat filter had a removal rate of suspended solids of 25 %. The bark filter, however, seemed to be releasing particles, the TSS was even higher after the bark filter than in the untreated water.

Water samples were sent to commercial laboratory for analysis of PHCs, PAH, phthalates, toxic metals including Cd, Cu, Cr, Pb, Zn, and Ni as well as major elements Fe, Al and Mn. Results from these water samples were not delivered in the time span of this thesis, but the analysis protocols are found in Appendix VII.

### 5.3 Future aspects

In this project both peat and bark were sieved to a comparable size as the granular carbon. Sieving peat and bark is time consuming and ends up with almost half of the original peat and bark being wasted. If the original fractions were to be used, a small scale testing of the hydraulic loading capacity should be performed to analyse their capacity compared to the sieved fractions. By including the larger, coarser, fraction



removed by sieving, a larger flow might have been possible to obtain through the columns (Chapter 2.3.3). From the material characterisation data, it cannot be said whether the sorption capacity would increase or decrease by using the original fractions. However, obtaining a sufficient hydraulic loading rate should perhaps be prioritised if not too much sorption capacity is lost.

During operation, it would be preferred not having to backwash the sorption media. Mainly because it is of interest to investigate when the filter media, especially peat and bark, reaches pollutant breakthrough without backwashing. If the materials have to be backwashed due to clogging, some of the sorbed pollutants may be washed away (Chapter 2.3.2). Another disadvantage is that the sorption filters need to be manually backwashed, which, for this study, is impractical in a long term perspective. Of the investigated materials peat was the only sorption material that showed promising results for a stabilising flow during the initial operation period of the plant. Both the GAC and bark filters clogged fairly fast. It could not be determined what caused the clogging, but a possible explanation could be that the sandfilter is insufficient in removing particles. In general, the bark filter had the least stable flow and the smallest volumes passing through the sorption media in the plant. The material characteristics also showed that it can be expected to have the lowest sorption capacity. If future sampling validates the results from the characterisation, an option would be to replace the bark with another filter material, for example granulated peat. If new materials are implemented, a material characterisation and testing of the hydraulic loading rate should be performed on a smaller sample of the material before ordering larger quantities for the pilot plant. This would prevent both unnecessary cost and material waste. Further, to obtain more reliable results from the laboratory testing, another method for the hydraulic loading rate should be considered to better simulate real conditions. An option would be using plastic columns with a larger diameter to create a more similar condition to the pilot plant.

Later in the project, continuous time-proportional sampling of 10 L/week will be implemented. The advantage of this sampling scheme is the simplicity of the method (McFarland & Hauck, 2001). However, it will probably give a skewed representation of the composition of pollutants in the water during storm events. Since sorption is affected by the quality of the water, it would be interesting to investigate the different removal efficiencies at different pollutant concentrations, e.g. first flush, heavy rains etc. This is not possible when using continuous sampling. The continuous sampling could however be complemented with grab samples collected at varying runoff conditions to get an indication of removal efficiencies at different pollutant concentrations.

Since it was not possible to place the pilot plant at the outlet of the Järnbrott stormwater pond, a sandfilter was added to simulate the particle separation that would have occurred in the pond. The original idea was to treat stormwater directly from the pond without further pre-treatment before the sorption filters. Considering how fast the sandfilter clogged, despite the rather clear incoming water, it would probably still be necessary to use sandfilters to prevent sorption filters from clogging if the pilot plant was placed after the stormwater pond. In fact, a study by Lavieille (2005) showed that the TSS concentration in the outlet of the pond is higher than the TSS measured in the incoming raw water in the pilot plant. In that case the sandfilter might clog even faster than now predicted if it was placed after the pond.

The pilot plant was designed to not be very dependent of regular maintenance. It is however difficult to design a completely passive operating system. The current design is dependent on a pump lifting stormwater to obtain enough elevation for gravity filtration. A plant could be designed to avoid lifting water, where the simplest way would be using the natural topography, leading water from a higher point to a lower, which is the same concept as in hydropower. As mentioned previously, this project showed that a sandfilter was vital for functional sorption filters. With a sandfilter that needs to be backwashed multiple times daily, an automatic backwashing function is essential. However in this projects early stage, after being installed and programmed, the automatic backwashing of the sandfilter worked satisfyingly with only minor maintenance, mostly due to start up corrections.

Regarding design aspects, some possible redesign considerations could include using an additional sandfilter to improve and ensure sufficient particle removal prior to the sorption filters. This could minimise the risk of particles leaching and thus clogging the sorption media. Further, using transparent columns would have been helpful as it would be possible to observe and study the filter media and the water inside the columns. It would enable observation of filter behaviour during backwashing and formation of channels through the material.

A column study is effectual when examining the efficiency of filter materials. However, considering how sorption filters could be permanently applied for treatment of larger quantities of stormwater, a column setup is probably not a viable solution. The low hydraulic loading rate in the peat and bark beds implies that the column size would have to be very large to accommodate higher flows. Further, the plant requires pumping and backwashing which is at the same time costly, time consuming and increases the risk for complications in the operation. A better solution could be to install filter beds, where a larger filter area could treat larger volumes of water, after the stormwater pond similarly to a constructed wetland. This is a low-cost, low-tech technique that would not require backwashing and pumping (de-Bashan & Bashan, 2004). The filter beds would, however, require a large land area and further studies on the pros and cons of such a solution and the applicability of a possible filter bed as a finishing treatment after the Järnbrott pond would have to be conducted.

In order to investigate the OP concentration in the colloidal and dissolved fractions in the water, a phase separation needs to be performed. For future analysis, a standard method to perform this phase separation should be developed, such as the method described in Chapter 2.2.1. The colloidal and dissolved fractions can be separated by using a solvent liquid-liquid extraction (LLE), but as the methods for determining the truly dissolved and colloidal fractions varies for different compounds, a standard method for the project should be investigated and determined.

## 6 Conclusions

This thesis project was initiated with a literature study covering common pollutants that are detected in urban runoff, as well as an investigation of sorption and filter techniques and sorption filter materials. This was performed in order to generate an optimal design for a column filter pilot plant, for the purpose of studying the removal of pollutants in the dissolved and colloidal phase in stormwater. Further the aim was to find three suitable sorption filter materials for examination of their removal efficiency for the pollutants presented in the literature study. The filter materials that were chosen for the study were granulated activated carbon (GAC), Sphagnum peat and pine (*Pinus sylvestris*) bark.

Physical and chemical properties of the chosen filter materials were characterised to compare the materials and estimate sorption capacity. The GAC mainly consisted of particles in the size of 0.5 – 2 mm, therefore the peat and the bark was sieved to the same size range. Characterisation was performed on both the original (non-sieved) and the sieved fraction of the peat and bark. Based on the results of the characterisation, no conclusion could be made on whether the original or sieved fractions is expected to have higher sorption capacities. To increase the comparability with GAC, the sieved fractions of the peat and bark were used in the pilot plant. The analyses showed that GAC had incomparably the highest surface area, a result indicating that the GAC filters should have the highest capacity for sorption. Bark is expected to have the lowest capacity for sorption, having both lower surface area and cation exchange capacity than the peat.

The pilot plant was located in Järnbrott, Gothenburg. The pilot plant was designed with an initial sandfilter column from which water was led into three parallel sorption columns. Gravity filtration was obtained through all filters by pumping stormwater into an elevated tank constantly feeding the sandfilter with water. The sandfilter was designed with automatic backwashing and the sorption filters were designed to allow backwashing if necessary. Five water sampling points were implemented; before the sandfilter, after the sandfilter and after each sorption filter.

From start-up (initiation), the flow through the pilot plant was studied for ten consecutive days. Due to sandfilter headloss by clogging, a regular backwashing interval was set to every 12 hours. GAC, peat and bark were initiated at a flow of 2 L/min respectively. The flow through the GAC and bark filters did not stabilise and they were both backwashed once during the study period. The flow through the peat filter initially decreased, but started to stabilise at a flow of 0.6 L/min. None of the sorption filters could meet the desired hydraulic loading rate obtained in laboratory tests.

If analysis of the water samples from the pilot plant validates the results from the material characterisation, the bark filter might be exchanged for another sorption material. Further, the filter columns showed to be limited in hydraulic loading rates. If remediation using sorption techniques was to be applied on larger quantities of stormwater, an option could be implementing sorption filter beds. If creating new columns or beds with peat as a sorption filter, it should be considered using the original fraction (non-sieved). The difference in sorption capacity between the original and the sieved fraction is likely to be minor.

## 7 References

- Abdallah, M. A.-E., 2015. Persistent Organic Pollutants. In: R. Hester & R. Harrison, eds. *Still Only One Earth: Progress in the 40 Years Since the First UN Conference on the Environment*. s.l.:The Royal Society of Chemistry, pp. 150-186.
- Ahlman, S., 2006. *Modelling of Substance Flows in Urban Drainage Systems*, Göteborg: Chalmers University of Technology, Division of Water Environment Technology.
- Ahmaruzzaman, M., 2008. Adsorption of phenolic compounds on low-cost adsorbents: A review. *Advances in Colloid and Interface Science*, Volume 143, pp. 48-67.
- Aksu, Z., 2005. Application of biosorption for the removal of organic pollutants: a review. *Process Biochemistry*, 40(3-4). pp. 997 – 1026.
- Ali, I., Asim, M., Khan & A., T., 2012. Low cost adsorbents for the removal of organic pollutants from wastewater. *Journal of Environmental Management*, Volume 113, pp. 170-183.
- Allen, S., McKay, G. & Porter, J., 2004. Adsorption isotherm models for basic dye adsorption by peat in single and binary component systems. *Journal of Colloid and Interface Science*, 280(2), pp. 322-333.
- ATSDR, 2011. *Agency for Toxic Substances and Disease Registry - Total Petroleum Hydrocarbons (TPH)*. [Online]  
Available at: <http://www.atsdr.cdc.gov>  
[Accessed 25 02 2016].
- Babel, S., Kurniawan T.A. 2003. Low-cost adsorbents for heavy metals uptake from contaminated water: a review. *Journal of Hazardous Materials*, 97(1-3). pp. 219-243.
- Baird, C. & Cann, M., 2008. *Environmental Chemistry*. 4th ed. s.l.:W.H. Freeman and Company.
- Barbé, D. E., Cruise, J. F. & Mo, X., 1996. Modeling The Buildup And Washoff Of Pollutants On Urban Watersheds. *JAWRA - Journal of the American Water Resources Association*, 32(3), pp. 511-519.
- de-Bashan, Luz E., Bashan, Yoav. 2004. Recent advances in removing phosphorus from wastewater and its future use as fertilizer (1997-2003). *Water Research*. Vol. 38. pp. 4222-4246.
- Bergil, C. & Bydén, S., 1995. *Måta försurning*. 2nd ed. Göteborg: Institutionen för tillämpad miljövetenskap, Göteborgs universitet .
- Björklund, K., Cousins, A. P., Strömvall, A.-M. & Malmqvist, P.-A., 2009. Phthalates and nonylphenols in urban runoff: Occurrence, distribution and area emission factors. *Science of the Total Environment*, Volume 407, pp. 4665-4672.
- Björklund, K. & Li, L., 2015. Evaluation of low-cost materials for sorption of hydrophobic organic pollutants in stormwater. *Journal of Environmental Management*, Volume 159, pp. 106-114.

- Björklund, K., Strömwall, A.-M. & Malmqvist, P.-A., 2011. Screening of organic contaminants in urban snow. *Water Science & Technology*, Volume 64, pp. 206-213.
- Boström, C. et al., 2002. Cancer risk assessment, indicators, and guidelines for polycyclic aromatic hydrocarbons in the ambient air. *Environmental Health Perspectives*, 110(3), pp. 451-488.
- Breacher, R., 2006. Petroleum Hydrocarbons. *HazMat Management*, 17(6), p. 42.
- Bressy, A. et al., 2012. Towards the determination of an optimal scale for stormwater quality management: Micropollutants in a small residential catchment. *Water Research*, 46(20), pp. 6799-6810.
- Brorström-Lundén, E. et al., 2010. *Results from the Swedish National Screening Programme 2008. Screening of unintentionally produced organic contaminants*, Göteborg: IVL Swedish Environmental Research Institute.
- Brown, P., Gill, S. & Allen, S., 2000. Metal removal from wastewater using peat. *Water Research*, 34(16), pp. 3907-3916.
- Chalmers WET, 2014. Treatment processes. In: *Drinking Water Engineering - Course Compendium*. Göteborg: Chalmers University of Technology, pp. 149-155.
- Chowdhury, Z., Summers, R. S. & Westerhoff, G. P., 2012. *Activated Carbon : Solutions for Improving Water Quality*. s.l.:American Water Works Association.
- Clara, M. et al., 2010. Occurrence of phthalates in surface runoff, untreated and treated wastewater and fate during wastewater treatment. *Chemosphere*, Volume 78, pp. 1078 - 1084.
- Clements, M. & Haarhoff, J., 2004. Practical experience with granular activated carbon (GAC) at the Rietvlei Water Treatment Plant. *Water SA*, 30(1).
- Coquery, M., Morin, A., Bécue, A. & Lepot, B., 2005. Priority substances of the European Water Framework Directive: analytical challenges in monitoring water quality. *Trends in Analytical Chemistry*, 24(2), pp. 117-127.
- Davis, A. P., Shokouhian, M. & Ni, S., 2001. Loading estimates of lead, copper, cadmium, and zinc in urban runoff from specific sources. *Chemosphere*, 44(5), pp. 997-1009.
- Davies, P. J., Wright, I. A., Jonasson, O. J. & Findlay, S. J., 2010. Impact of concrete and PVC pipes on urban water chemistry. *Urban water journal*, 7(4), pp. 233-241.
- Enell, Anja., 2006. *Leaching of Polycyclic Aromatic Hydrocarbons Using a Column Method*, Lund: Lund University, Department of Chemical Engineering.
- Erickson, A. J., Weiss, P. T. & Gulliver, J. S., 2013. *Optimizing Stormwater Treatment Practices*. New York: Springer-Verlag.
- European Union, 2015. *The Water Framework Directive and the Floods Directive: Actions towards the 'good status' of EU water and to reduce flood risks*, s.l.: s.n.
- Fengel, D. & Wegener, G (eds) 1983, *Wood : chemistry, ultrastructure, reactions*, De Gruyter, Berlin/Boston, DE. Available from: ProQuest ebrary. [2 June 2016].

- C. & Özgür, A., 2011. *Activated Carbon for Water and Wastewater Treatment*. s.l.:John Wiley & Sons .
- Färm, C., 2002. Metal sorption to natural filter substrates for storm water treatment – column studies. *Science of The Total Environment*, 298(1-3), pp. 17-24.
- Gardea-Torresdey, J., Tang, L. & Salvador, J., 1996. Copper adsorption by estrified and unestrified fractions of Dohagnum peat moss and its different humic substances. *Journal of Hazardous Materials*, Volume 48, pp. 191-206.
- Genc-Fuhrman, H., Mikkelsen, P. S. & Ledin, A., 2006. Simultaneous removal of As, Cd, Cr, Cu, Ni and Zn from stormwater: Experimental comparison of 11 different sorbents. *Water Research*, Volume 41, pp. 591-602.
- German, J. & Svensson, G., 2002. Metal content and particle size distribution of street sediments and street sweeping waste. *Water Science and Technology*, 46(6-7), pp. 191-198.
- German, J. & Svensson, G., 2005. Stormwater pond sediments and water—characterisation and assessment. *Urban Water Journal*, 2(1), pp. 39-50.
- Gliński, J., Horabik, J. & Lipiec, J., 2011. *Encyclopedia of Agrophysics*. s.l.:s.n.
- Gupta, B. S., Curran, M., Hasan, S. & Gosh, T., 2009. Adsorption characteristics of Cu and Ni on Irish peat moss. *Journal of Environmental Management*, 90(2), pp. 952-960.
- Göteborg Stad, 2015. *Program för Nordöstra Högsbo*, Göteborg: Göteborg Stad - Kretslopp och vatten.
- Heudorf, U., Mersch-Sundermann, V. & Angerer, J., 2007. Phthalates: Toxicology and exposure. *International Journal of Hygiene and Environmental Health*, 210(5), pp. 623-624.
- Hoffman, E. J. et al., 1984. *Stormwater Runoff From Highways*, Narragansett: University of Rhode Island.
- Hvitved-Jacobsen, T., Vollertsen, J., Haaning Nielsen, A., 2010. *Urban and Highway Stormwater Pollution : Concepts and Engineering*. Taylor & Francis Group. Boca Raton.
- ICPS, 1995. *Persistent Organic Pollutants*, Ontario,Canada: The International Program on Chemical Safety (IPCS) - Inter-Organization Programme for the Sound Management of Chemicals (IOMC) .
- Jakobsson, A., 2003. *Tungmetaller och PAH i ett efterbehandlingssystem för vägdragvatten i Gårda*, Göteborg: Department of Chemical Engineering, Chalmers University of Technology.
- Jusoh, A., Shiung, L.S., Ali, N., Noor, M.J.M.M. 2007. A simulation study of the removal efficiency of granular activated carbon on cadmium and lead. *Desalination* 206(1-3). pp. 9-16.
- Kalmykova, Y., 2009. *Alternative Sorption Materials for Contaminated Water Treatment*, Göteborg: Chalmers University of Technology.

Kalmykova, Y., Björklund, K., Strömwall, A.-M. & Blom, L., 2013. Partitioning of polycyclic aromatic hydrocarbons, alkylphenols, bisphenol A and phthalates in landfill leachates and stormwater. *Water Research*, 47(3), pp. 1317-1328.

Kalmykova, Y., Moona, N., Strömwall, A.-M. & Björklund, K., 2014. Sorption and degradation of petroleum hydrocarbons, polycyclic aromatic hydrocarbons, alkylphenols, bisphenol A and phthalates in landfill leachate using sand, activated carbon and peat filters. *Water Research*, Volume 56, pp. 246-257.

Kalmykova, Y., Strömwall, A.-M., Rauch, S. & Morrison, G., 2009b. Peat filter performance under changing environmental conditions. *Journal of Hazardous Materials*, 166(1), pp. 389-393.

Kalmykova, Y., Strömwall, A.-M. & Steenari, B.-M., 2008a. Adsorption of Cd, Cu, Ni, Pb and Zn on Sphagnum peat from solutions with low metal concentrations. *Journal of Hazardous Materials*, Volume 152, pp. 885-891.

Kalmykova, Y., Strömwall, A.-M. & Steenari, B.-M., 2008b. Alternative materials for adsorption of heavy metals and petroleum hydrocarbons from contaminated leachates. *Environmental Technology*, Volume 29, pp. 111-122.

Kayhanian, M., Suverkopp, C., Ruby, A. & Tsay, K., 2007. Characterisation and prediction of highway runoff constituent event mean concentration. *Journal of Environmental Management*, Volume 85, pp. 279-295.

Krewer, D. & Moona, N., 2012. *Adsorption of Organic Pollutants in Peat and Carbon filters: A Pilot Study of Landfill Leachate*, Göteborg: Chalmers University of Technology, Department of Civil and Environmental Engineering.

Lantmäteriet, 2016. *Kartsök och ortsnamn*. [Online]  
Available at: <https://kso.etjanster.lantmateriet.se/#>  
[Accessed 12 04 2016].

Lavieille, D., 2005. *Järnbrott Stormwater Pond - Evolution of the Pollutant Removal Efficiency and Release from Sediments*, Göteborg: Department of Civil and Environmental Engineering, Chalmers University of Technology.

Lenntech, n.d. *Water Treatment Solutions*. [Online]  
Available at: <http://www.lenntech.com/>  
[Accessed 16 02 2016].

Liljegren, R., n.d. *Nationalencyklopedin - torv*. [Online]  
Available at: <http://www.ne.se/uppslagsverk/encyklopedi/l%C3%A5ng/torv>  
[Accessed 29 01 2016].

Liu, Q.-S. et al., 2010. Adsorption isotherm, kinetic and mechanism studies of some substituted phenols on activated carbon fibers. *Chemical Engineering Journal*, 157(2-3), pp. 348-356.

Lundstedt, S. et al., 2007. Sources, Fate, and Toxic Hazards of Oxygenated Polycyclic Aromatic Hydrocarbons (PAHs) at PAH-contaminated Sites. *Ambio*, 36(6), pp. 475-485.

- Ma, J., Zhu, L. 2006. Simultaneous sorption of phosphate and phenanthrene to inorgano-organobentonite from water. *Journal of Hazardous Materials*, 136(3). pp. 982-988.
- Metcalf & Eddy, 2004. *Advanced Wastewater Treatment. In: Wastewater Engineering - Treatment and reuse*. Fourth Edition ed. New York: McGraw-Hill, pp. 1037-1096, 1138-1161.
- Mohan, S.V., Shailaja, S., Rama Krishna, M., Sarma, P.N. 2007. Adsorptive removal of phthalate ester (Di-ethyl phthalate) from aqueous phase by activated carbon: A kinetic study. *Journal of Hazardous Materials*, 146(1-2). pp. 278-282.
- National Food Agency, Sweden, 2015. *Polycykliska aromatiska kolväten (PAH)*. [Online] Available at: <http://www.livsmedelsverket.se/livsmedel-och-innehall/oonskade-amnen/miljogifter/polycykliska-aromatiska-kolvaten-pah/#F%C3%B6rdjupning> [Accessed 04 04 2016].
- Nationalencyklopedin, 2016. *Kolväten*. [Online] Available at: <http://www.ne.se/> [Accessed 16 02 2016].
- Nehrenheim, E. & Gustafsson, J., 2008. Kinetic sorption modelling of Cu, Ni, Zn, Pb and Cr ions to pine bark and blast furnace slag by using batch experiments. *Bioresource Technology*, 99(6), pp. 1571-1577.
- Nielsen, K. et al., 2015. Particle phase distribution of polycyclic aromatic hydrocarbons in stormwater — Using humic acid and iron nano-sized colloids as test particles. *Science of The Total Environment*, Volume 531, pp. 103-111.
- McFarland, Anne, Hauck, Larry. 2001. *Strategies for Monitoring Nonpoint Source Runoff*. UDSA.
- Ming, D. & Dixon, J. 1987. Quantitative determination of clinoptilolite in soils by a cation-exchange capacity method. *Clays and Clay Minerals*, 35(6), pp. 463-468.
- O'Sullivan, G. & Megson, D., 2014. Brief Overview: Discovery, Regulation, Properties, and Fate of POPs . In: G. O'Sullivan & C. Sandau, eds. *Environmental forensics for persistent organic pollutants*. s.l.:Elsevier, pp. 1-20.
- Palma, G., Freer, J. & Beaza, J., 2003. Removal of metal ions by modified *Pinus radiata* bark and tannins from water solutions. *Water Research*, 37(20), pp. 4974-4980.
- Park, C. & Allaby, M., 2013. *A Dictionary of Environment and Conservation*. 2nd ed. Oxford: Oxford University Press.
- petroleum.co.uk, 2015. *Fuel from crude*. [Online] Available at: <http://www.petroleum.co.uk> [Accessed 25 02 2016].
- Pettersson, T., 1999. *Stormwater Ponds for Pollution Reduction*, Göteborg: Chalmers University of Technology.



- Ravindra K., Sokhi R., Van Grieken R. 2008. Atmospheric polycyclic aromatic hydrocarbons: Source attribution, emission factors and regulation. *Atmospheric Environment* 42. pp 2895–2921, Elsevier
- Ray, A. B., Selvakumar, A. & Tafuri, A. N., 2006. Removal of selected pollutants from aqueous media by hardwood mulch. *Journal of Hazardous Materials*, 136(2), pp. 213-218.
- Reed, Brian E., Maqbul, Jamil, Bob, Thomas, 1996. Effect of pH, empty bed contact time and hydraulic loading rate on lead removal by granular activated carbon columns. *Water Environment Research*, 68(5), pp. 887-882.
- Reddy, K. R., Xie, T. & Dastgheibi, S., 2014. Removal of heavy metals from urban stormwater runoff using different filter materials. *Journal of Environmental Chemical Engineering*, Volume 2, pp. 282-292.
- Rensselaer Polytechnic Institute, n.d. *Sand Filtration*. [Online]  
Available at: <http://www.rpi.edu/dept/chem-eng/Biotech-Environ/FILTRATION/sand.htm>  
[Accessed 11 04 2016].
- Ringqvist, L., Holmgren, A. & Öborn, I., 2002. Poorly humified peat as an adsorbent for metals in wastewater. *Water Research*, Volume 36, pp. 2394-2404.
- Rogge, W.F., Hildemann, L.M., Mazurek, M.A., Cass, G.R., Simoneit, B.R.T. 1993. Sources of fine organic aerosol. 2. Noncatalyst and catalyst-equipped automobiles and heavy-duty diesel trucks. *Environmental Science & Technology*, 27 (4). pp 636-651.
- Samanta, S. K., Singh, O. V. & Jain, R. K., 2002. Polycyclic aromatic hydrocarbons: environmental pollution and bioremediation. *Trends in Biotechnology*, 20(6), pp. 243-248.
- SGU, n.d. *Torv – från sjö till torvmark*. [Online]  
Available at: <http://www.sgu.se/om-geologi/jord/fran-istid-till-nutid/erosion-och-igenvaxning/torv-fran-sjo-till-torvmark/>  
[Accessed 29 01 2016].
- Sheldrick, B.H, 1984. *Analytical methods manual 1984*, Ottawa, Ontario: Land Resource Research Institute.
- Siopi, A., 2015. *Substance Flow Analysis (SFA) of Polycyclic Aromatic Hydrocarbons (PAHs) in Road Runoff*. Göteborg: Chalmers University of Technology
- Sjöström, Eero, 1993. *Wood Chemistry- Fundamentals and Applications*. 2<sup>nd</sup> ed. Elsevier.
- Socialstyrelsen, 2009. *Miljöhälsorapport 2009*, s.l.: Swedish National Board of Health and Welfare .
- Stömwall, A.-M., Norin, M. & Pettersson, T., 2007. Organic contaminants in urban sediments and vertical leaching in road ditches. *Highway and Urban Environment: Proceedings of the 8th Highway and Urban Environment Symposium*, pp. 235-247.
- Sud, D., Mahajan, G. & Kaur, M., 2008. Agricultural waste material as potential adsorbent for sequestering heavy metal ions from aqueous solutions – A review. *Bioresource technology*, Volume 99, pp. 6017-6027.

Swedish Chemicals Agency, 2014. *Förslag till utfasning av fortplantningsstörande och hormonstörande ftalater i Sverige*, Stockholm, Sweden: Swedish Chemicals Agency.

Swedish EPA, 2007. *Oavsiktligt bildade ämnens hälso- och miljörisker, Rapport 5736*, s.l.: Naturvårdsverket.

Swedish EPA, 2009. *Di-(2etylhexyl)-ftalat (DEHP)*. [Online]  
Available at: <http://utslappisiffror.naturvardsverket.se/Amnen/Ovriga-organiska-amnen/DEHP/>  
[Accessed 25 02 2016].

Swedish EPA, 2010. *Polyaromatiska kolväten (PAH)*. [Online]  
Available at: <http://utslappisiffror.naturvardsverket.se/Amnen/Ovriga-organiska-amnen/Polyaromatiska-kolvaten/>  
[Accessed 16 02 2016].

Swedish EPA, 2014. *Organiska miljögifter*. [Online]  
Available at: <http://www.naturvardsverket.se/Sa-mar-miljon/Manniska/Miljogifter/Organiska-miljogifter/>  
[Accessed 21 01 2016].

Swedish EPA, 2016. *Utsläpp av polycykliska aromatiska kolväten, PAH, till luft*. [Online]  
Available at: <http://www.naturvardsverket.se/Sa-mar-miljon/Statistik-A-O/PAH-till-luft/>  
[Accessed 04 04 2016].

Swedish Water Authorities, 2015. *Miljögifter*. [Online]  
Available at: <http://www.vattenmyndigheterna.se/Sv/bottenviken/beslut-fp/miljoproblem/Pages/miljogifter.aspx>  
[Accessed 21 01 2016].

Sörme, L. & Lagerkvist, R., 2002. Sources of heavy metals in urban wastewater in Stockholm. *Science of The Total Environment*, 298(1-3), pp. 131-145.

TPH Criteria Working Group, 1998. *Analysis of Petroleum Hydrocarbons in Environmental Media*, Amherst: Amherst Scientific Publishers.

University of York, 2013. *The Essential Chemical Industry - Distillation*. [Online]  
Available at: <http://www.essentialchemicalindustry.org>  
[Accessed 25 02 2016].

US CDC, 2015. *Centers for Disease Control and Prevention - Factsheet Phthalates*. [Online]  
Available at: [http://www.cdc.gov/biomonitoring/Phthalates\\_FactSheet.html](http://www.cdc.gov/biomonitoring/Phthalates_FactSheet.html)  
[Accessed 25 February 2016].

US EPA, 2009. *Persistent Organic Pollutants: A Global Issue*. [Online]  
Available at: <http://www.epa.gov/international-cooperation/persistent-organic-pollutants-global-issue-global-response>  
[Accessed 22 February 2016].

Vaze, J. & Chiew, F., 2004. Nutrient loads associated with different. *Journal of*, 124(7), pp. 587-592.

- Vaze, J. & Chiew, F. H., 2002. Experimental study of pollutant accumulation on an urban road surface. *Urban Water*, 4(4), pp. 379-389.
- Vázquez, G. et al., 2002. Removal of cadmium and mercury ions from aqueous solution by sorption on treated *Pinus pinaster* bark: kinetics and isotherms. *Bioresource Technology*, 82(3), pp. 247-251.
- WHO, 2005. *Petroleum Products in Drinking-water*, s.l.: World Health Organization.
- Wik, A., Lycken, J. & Dave, G., 2008. Sediment Quality Assessment of Road Runoff Detention Systems in Sweden and the Potential Contribution of Tire Wear. *Water Air Soil Pollution*, Volume 194, pp. 301-314.
- Worch, E., 2012. *Adsorption Technology in Water Treatment - Fundamentals, Processes, and Modeling*. s.l.:De Gruyter.
- Zgheib, s., Moillerom, R., Saad, M. & Chebbo, G., 2011. Partition of pollution between dissolved and particulate phases: what about emerging substances in urban stormwater catchments?. *Water Research*, 45(2), pp. 913-925.
- Zgheib, S., Moilleron, R. & Chebbo, G., 2012. Priority pollutants in urban stormwater: Part 1 - Case of separate storm sewers. *Water Research*, Volume 46, pp. 6683-6692.



# APPENDIX

## APPENDIX I– PRODUCER INFORMATION ON SORPTION MATERIAL

### ScanPeat Blocktory

#### RHP review

560 / 41



Scanpeat AB  
Wennerbergsgatan  
S-28732 Strömsnäsbruk  
Zweden

RHP code: SCASTR  
Locatiecode: SCAGOL

Review number: M41-MOD560-22426

#### Sample information

Laboratory:	BLGG	Category:	A
Analyse no:	116747	Status:	Controle
Date of receipt:	07-07-2015	Scope:	Horticulture
Date of sampling:	15-06-2015	Sample taken by:	Bedrijf
Product:	Veen Horticulture		

Sample descr: Fine Block of Gólmossen

#### Analyse result

Analyse results:			Review: (goed = ok / wijkt af = deviation)
Moisture content:	19	%	goed
Organic matter:	99	%	goed
Air content:	42	%	goed
Bulk density:	90	kg/m <sup>3</sup>	
Pores:	94	%	
Water:	52	%	
Water org matter:	5,6	g/g dry matter	goed
Water ratio:	49,9	%	

#### RHP final review:

\* = deviating from the RHP standard or specification

The analyse results are reviewed against the actual RHP standards of the stated module.

This result is in compliance with the actual standard

Review date: 17-9-2015

**RHP review**

560 / 22



Scanpeat AB  
Wennerbergsgatan  
S-28732 Strömsnäsbruk  
Zweden

RHP code: SCASTR  
Locatie code: SCAGOL

Review number: M22-56136

**Sample information**

Laboratory:	BLGG	Category:	A
Analyse no:	378841	Status:	Controle
Date of receipt:	31-08-2015	Sample taken by:	Bedrijf
Date of sampling:	20-08-2015	Scope:	Horticulture
Product:	veen Horticulture		
Sample descr:	Fine of Blocks Gölmossen		

**Analyse result**

Analyse results:			Review: (goed = ok / wijkt af = deviation)
Chroom (Cr)	< 3	mg/kg (mg/liter)	goed
Nikkel (Ni)	< 2,7	mg/kg (mg/liter)	goed
Koper (Cu)	< 4,2	mg/kg (mg/liter)	goed
Zink (Zn)	< 6,3	mg/kg (mg/liter)	goed
Arseen (As)	< 1,10	mg/kg (mg/liter)	goed
Cadmium (Cd)	0,13	mg/kg (mg/liter)	goed
Kwik (Hg)	0,03	mg/kg (mg/liter)	goed
Lood (Pb)	7,8	mg/kg (mg/liter)	goed

**RHP final review:**

The analyse results are reviewed against the actual RHP standards of the stated module.

This result is in compliance with the actual standard

-

Review date: 8-9-2015

## Zugol granulated pine bark

Company data sheet containing information regarding the physical and chemical properties of the pine bark. Only available in Swedish. For information in English, visit [www.zugol.se](http://www.zugol.se), or use company contact information stated under point 1 in the data sheet.

### SÄKERHETSATABLAD

Handelsnamn: Zugol Miljöskyddsmedel  
Tillverkare: Zugol AB Svensk Barkindustri

Datum: 2005-12-15

Utfärdare: Åke Fahlvik

SB V 1103.3

#### 1. Namnet på produkten och företaget

Handelsnamn: **Zugol Miljöskyddsmedel**  
Varunummer: 44 01 30 90  
Tillverkare: Zugol AB Svensk Barkindustri  
Österå 145, 791 91 FALUN  
Tel 023-300 69 Fax 023-301 92  
E-post: [info@zugol.com](mailto:info@zugol.com)  
Nödfallstelefon: 070-625 67 09

#### 2. Sammansättning/ämnenas klassificering

Ämne/beredning: Sorterad, torkad och granulerad furubark samt träfiber av fura.

##### Farliga ämnen:

Kemiskt namn	CAS-nr	%	Farokod	Riskfraser	EU-nr
Inga	-	-	-	-	-

##### Övriga ämnen:

Kemiskt namn	CAS-nr	%	Farokod	Riskfraser	EU-nr
Torkad och granulerad furubark	-	85%	-	-	-
Träfiber	-	-	15%	-	-

#### 3. Farliga egenskaper

Hälsorisker: Kan vara irriterande på grund av visst torrt damm.  
Miljöeffekter: Inga.  
Fysikaliska/kemiska risker: Brännbart.

#### 4. Första hjälpen

##### Symtom och effekter:

Inandning: Kan vara irriterande på grund av visst torrt damm.  
Hudkontakt: -  
Kontakt med ögon: Kan vara irriterande på grund av visst torrt damm.  
Förtäring: -

##### Åtgärder för första hjälpen

Inandning: Skölj med rent vatten.  
Hudkontakt: Tvätta med vatten.  
Kontakt med ögon: Skölj med rent vatten.  
Förtäring: Skölj med rent vatten.

Information till läkare: -

#### 5. Åtgärder vid brand

Säkerhetsdatablad

© 2000 Br Tranberg HB

Sid.nr 1(5)

## SÄKERHETSATABLAD

Handelsnamn: Zugol Miljöskyddsmedel  
Tillverkare: Zugol AB Svensk Barkindustri

Datum: 2005-12-15

Utfärdare: Åke Fahlvik

SB V 1103.3

Lämpliga släckmedel:	Vatten.
Olämpliga släckmedel:	-
Brand/explosionsrisker:	Låg vid 7,5% kornstorlek < 0,25 mm.
Farliga förbränningsprodukter:	Brandgaser.
Skyddsutrustning för räddningspersonal:	-



## SÄKERHETSATABLAD

Handelsnamn: Zugol Miljöskyddsmedel  
Tillverkare: Zugol AB Svensk Barkindustri

Datum: 2005-12-15

Utfärdare: Åke Fahlvik

SB V 1103.3

### 6. Åtgärder vid spill/oavsiktliga utsläpp

Personliga skyddsåtgärder: Undvik inandning och kontakt med ögonen.  
Miljöskyddsåtgärder: -  
Saneringsmetoder: Sopa upp.

### 7. Hantering och lagring

Hantering: Torr plats.  
Lagring: Torrt, obegränsad lagringstid.  
Förpackningsmaterial: Plastsäck (polyetylen).

### 8. Begränsning av exponeringen/Personliga skyddsåtgärder

Tekniska åtgärder: -  
Hygieniska åtgärder: Undvik damning.  
Personlig skyddsutrustning: -

Övrig skyddsutrustning: -

### 9. Fysikaliska och kemiska egenskaper

Tillstånd:	Granulat	Färg:	Brunaktig	Lukt:	Trä
Koncentration:	-	pH:	4,4	Täthet:	250 kg/m <sup>3</sup>
Kokpunkt:	-	Smältpunkt:	-	Flampunkt:	-
Brinnpunkt:	235-280 °C	Brandfarlighet:	Låg	Ångtryck:	-
Explosionsgränser:	-	Explosiva egenskaper:	Låg	Oxiderande egenskaper:	-
Löslighet i vatten:	-	Löslighet:	-	Övrigt:	-
Fördelningskoefficient (n-oktanol/vatten):	-				

### 10. Stabilitet och reaktivitet

Förhållanden som bör undvikas: Finfraktion med kornstorlek < 0,25 mm kan medföra risk för dammexplosion i grupp I (se AFS 1981:5) om den anrikas.

Material som bör undvikas: Bör ej användas på salpetersyraspill. Nitrosera gaser kan utvecklas.

Farliga omvandlingsprodukter: Brandgaser som koloxid och koldioxid.

### 11. Toxikologisk information

Akut giftighet: -  
Kronisk giftighet: Ej cancerogent.  
Forskningsrön: -

### 12. Ekotoxikologisk information

Rörlighet: -  
Nedbrytbarhet: Lätt tack vare innehåll av oljenedbrytande mikroorganismer.  
Ackumulering: Nej

Toxicitet	Vattenorganismer	Markorganismer	Växter	Djur
-----------	------------------	----------------	--------	------

Säkerhetsdatablad

© 2000 Br Tranberg HB

Sid.nr 3(5)

## SÄKERHETSATABLAD

Handelsnamn: Zugol Miljöskyddsmedel  
Tillverkare: Zugol AB Svensk Barkindustri

Datum: 2005-12-15

Utfärdare: Åke Fahlvik

SB V 1103.3

Akuta effekter:	-	-	-	-	-	-
Långtidseffekter:	-	-	-	-	-	-
Övriga effekter:	-	-	-	-	-	-

## SÄKERHETSATABLAD

Handelsnamn: Zugol Miljöskyddsmedel  
Tillverkare: Zugol AB Svensk Barkindustri

Datum: 2005-12-15

Utfärdare: Åke Fahlvik

SB V 1103.3

### 13 Avfallshantering

Produktrester: Kan användas som nytt material.  
Föreanade förpackningar: Kan återvinnas som polyetylenplast.  
Farligt avfall EWC-kod  
(SPS 1996:971,bilaga 2): Nej

Använd produkt hanteras som det absorberade materialet kräver.

### 14. Transportinformation

IMDG-klass:	-	Page:	-	MFAG Nr:	-
ADR/RID,ADR-S/RID-S Klass:	-	Varunr:	44013090	Faronr:	-
ICAO/IATA-klass:	-	EmS Nr:	-	FN-nr:	-
Förpackningsgrupp:	-	Övrigt:	-		

### 15. Gällande bestämmelser

**EU-föreskrifter:**  
EU-klassificering: 67/548/EEC senast ändrad 98/98/EG-88/379/EEC senast ändrad 96/65/EG. KIFS 1998:8, 91/155/EEG ändrad 93/112/EEG, ISO 11014-1. KIFS 1999:3.  
Farosymbol: Icke hälsofarlig  
R-fraser: -  
S-fraser: -  
Innehåller: -

#### **Nationella föreskrifter**

Sverige:  
Hygieniska gränsvärden: AFS 2000:3  
Totaldamm: 2 mg/m<sup>3</sup> (K)  
För nya anläggningar 1 mg/m<sup>3</sup> (K)

### 16. Övrig information

Rekommenderad användning: Absorptionsmedel för petroleumprodukter, emulsioner, skärvätskor, glykol, färg, lack, urin, blod mm

Utbildningskrav: -  
Källa: -  
Kontaktperson: Åke Fahlvik, Mobil 070-625 67 09.  
Interna skyddsföreskrifter: -

# FILTRASORB® 400

Granular Activated Carbon

### Applications



FILTRASORB 400 activated carbon can be used in a variety of liquid phase applications for the removal of dissolved organic compounds. FILTRASORB 400 has been successfully applied for over 40 years in applications such as drinking and process water purification, wastewater treatment, and food, pharmaceutical, and industrial purification.

### Description

FILTRASORB 400 is a granular activated carbon for the removal of dissolved organic compounds from water and wastewater as well as industrial and food processing streams. These contaminants include taste and odor compounds, organic color, total organic carbon (TOC), and industrial organic compounds such as TCE and PCE.

This activated carbon is made from select grades of bituminous coal through a process known as reagglomeration to produce a high activity, durable, granular product capable of withstanding the abrasion associated with repeated backwashing, hydraulic transport, and reactivation for reuse. Activation is carefully controlled to produce a significant volume of both low and high energy pores for effective adsorption of a broad range of high and low molecular weight organic contaminants.

FILTRASORB 400 is formulated to comply with all the applicable provisions of the AWWA Standard for Granular Activated Carbon (B604) and Food Chemicals Codex. This product may also be certified to the requirements of ANSI/NSF Standard 61 for use in municipal water treatment facilities. Only products bearing the NSF Mark are certified to the NSF/ANSI 61 - Drinking Water System Components - Health Effects standard. Certified Products will bear the NSF Mark on packaging or documentation shipped with the product.

### Features / Benefits

- Produced from a pulverized blend of high quality bituminous coals resulting in a consistent, high quality product.
- Carbon granules are uniformly activated through the whole granule, not just the outside, resulting in excellent adsorption properties and constant adsorption kinetics.
- The reagglomerated structure ensures proper wetting while also eliminating floating material.
- High mechanical strength relative to other raw materials, thereby reducing the generation of fines during backwashing and hydraulic transport.
- Carbon bed segregation is retained after repeated backwashing, ensuring the adsorption profile remains unchanged and therefore maximizing the bed life.
- Reagglomerated with a high abrasion resistance, which provides excellent reactivation performance.
- High density carbon resulting in a greater adsorption capacity per unit volume.

### Specifications<sup>1</sup>

	FILTRASORB 400
Iodine Number, mg/g	1000 (min)
Moisture by Weight	2% (max)
Effective Size	0.55–0.75 mm
Uniformity Coefficient	1.9 (max)
Abrasion Number	75 (min)
Screen Size by Weight, US Sieve Series	
On 12 mesh	5% (max)
Through 40 mesh	4% (max)

<sup>1</sup>Calgon Carbon test method

### Typical Properties\*

	FILTRASORB 400
Apparent Density (tamped)	0.54 g/cc
Water Extractables	<1%
Non-Wettable	<1%

\*For general information only, not to be used as purchase specifications.

### Safety Message

Wet activated carbon can deplete oxygen from air in enclosed spaces. If use in an enclosed space is required, procedures for work in an oxygen deficient environment should be followed.

1.800.4CARBON calgoncarbon.com

© Copyright 2015 Calgon Carbon Corporation, All Rights Reserved  
DS-FILTRA40015-EIN-E1

### Typical Pressure Drop

Based on a backwashed and segregated bed

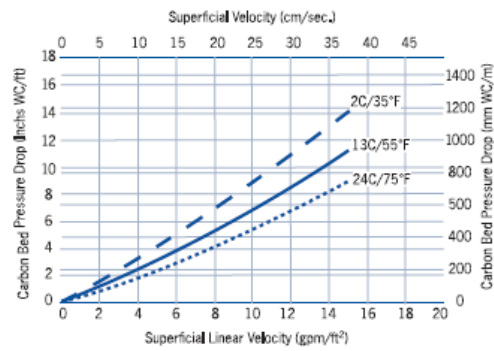

### Typical Bed Expansion During Backwash

Based on a backwashed and segregated bed

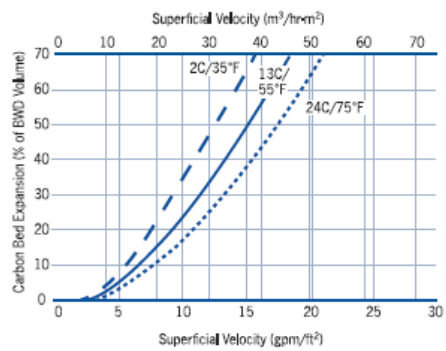

### Design Considerations

FILTRASORB 400 activated carbon is typically applied in down-flow packed-bed operations using either pressure or gravity systems. Design considerations for a treatment system is based on the user's operating conditions, the treatment objectives desired, and the chemical nature of the compound(s) being adsorbed.

### Safety Message

Wet activated carbon can deplete oxygen from air in enclosed spaces. If use in an enclosed space is required, procedures for work in an oxygen deficient environment should be followed.

1.800.4CARBON calgoncarbon.com

© Copyright 2015 Calgon Carbon Corporation, All Rights Reserved  
DS-FILTRA40015-EIN-E1

## APPENDIX II – CALCULATION OF HYDRAULIC LOADING RATE

### *Calculation of desired hydraulic loading rate in pilot plant*

Flow in pilot plant:  $Q = 2 \text{ l/min}$

Hydraulic loading rate:  $H_{LR} = \frac{Q}{A_{\text{column}}}$  where  $A_{\text{column}} = 7.06 \text{ dm}^2 \rightarrow H_{LR} = 0.283 \text{ dm/min} = 1.7 \text{ m/h}$

### *Hydraulic loading in test columns*

$A_{\text{test}} = 10.75 \text{ cm}^2$ ,  $H_{LR} = 1.7 \text{ m/h}$

$Q_{\text{test}} = A_{\text{test}} * H_{LR} = (10.75 * 10^{-4}) * 1.7 = 0.0018275 \text{ m}^3/\text{h} = 30.5 \text{ ml/min}$

*Maximum flows reached in laboratory tests:*

$Q_B = 400 \text{ ml/min} \rightarrow H_{LRB} = \frac{Q_B}{A_{\text{test}}} = \frac{400 * 10^{-6}}{10.75 * 10^{-4}} = 0.372 \text{ m/min} = 22 \text{ m/h}$

$Q_P = 50 \text{ ml/min} \rightarrow H_{LRT} = \frac{Q_P}{A_{\text{test}}} = \frac{50 * 10^{-6}}{10.75 * 10^{-4}} = 0.0465 \text{ m/min} = 2.7 \text{ m/h}$

Hydraulic loading rates from laboratory test gives a hypothetical maximum flow in the pilot plant:

$Q_{B,\text{plant}} = A * H_{LRB} = 0.0706 \text{ m}^2 * 22 \text{ m/h} = 1.5 \text{ m}^3/\text{h} = 25.9 \text{ l/min}$

$Q_{P,\text{plant}} = A * H_{LRT} = 0.0706 \text{ m}^2 * 2.7 \text{ m/h} = 0.19 \text{ m}^3/\text{h} = 3.2 \text{ l/min}$

## APPENDIX III — FULL RESULTS FROM MATERIAL CHARACTERISATION

### pH

Material	pH	
Bark	3,36	
Bark	3,35	
Bark 0.5 - 2 mm	3,17	
Bark 0.5 - 2 mm	3,17	
Peat	2,57	
Peat	2,57	
Peat 0.5 - 2 mm	2,6	
Peat 0.5 - 2 mm	-	Too little solution to measure pH (peat adsorbed solution)
GAC	10,89	

### Bulk density

Material	Bulk density [kg/m <sup>3</sup> ]
Peat 0.5 2 mm	74,93
Peat 0.5 2 mm	79,12
Peat	79,26
Peat	63,98
Bark	98,35
Bark	114,48
Bark 0.5 - 2 mm	118,88
Bark 0.5 - 2 mm	152,40

### Water content

Material	Water content [%]
Peat 0.5 - 2 mm	56,66905
Peat 0.5 - 2 mm	55,12761
Peat	61,12084
Peat	59,20763
Bark	37,09011
Bark	36,66518
Bark 0.5 - 2 mm	33,69309
Bark 0.5 - 2 mm	31,54271

Organic content

Material	Loss on ignition [%]
Peat 0.5 - 2 mm	98,19753
Peat 0.5 - 2mm	98,15979
Peat	96,44219
Peat	96,82721
Bark 0.5 - 2 mm	98,91228
Bark 0.5 - 2 mm	98,72782
Bark	98,65453
Bark	98,79211
GAC	87,33732
GAC	87,09899

Metal content

Material	Cr [mg/g]	Ni [mg/g]	Cu [mg/g]	Zn [mg/g]	Cd [mg/g]	Pb [mg/g]
Peat 0.5 - 2 mm	0,02308	0,01803	0,00911	0,01007	0,00533	0,01838
Peat 0.5 - 2 mm	0,00249	0,00919	0,00799	0,01790	0,00630	0,00399
Peat 0.5 - 2 mm	0,00336	0,00938	7,05945	0,06712	0,00019	0,00217
Peat	0,00288	0,00877	6,30896	0,05996	0,00021	0,00185
Peat	0,00355	0,01150	8,66633	0,08086	0,00020	0,00242
Peat	-0,00132	-0,00021	0,00308	-0,00197	0,00001	-0,00016
Bark 0.5 - 2 mm	0,00330	0,03006	0,01425	0,77446	0,00011	0,00058
Bark 0.5 - 2 mm	0,00827	0,05871	-0,00046	0,00226	0,00009	-0,00012
Bark 0.5 - 2 mm	-0,00139	-0,00028	-0,00010	-0,00351	0,00000	-0,00021
Bark	0,00080	0,01486	0,00292	0,00188	0,00003	0,00000
Bark	-0,00073	0,00050	0,00100	-0,00125	0,00027	0,00003
Bark	-0,00154	-0,00023	-0,00028	-0,00208	-0,00001	-0,00018
GAC	0,00230	0,00994	0,02218	0,04594	0,00016	0,00825
GAC	0,00175	0,00763	0,01489	0,03163	0,00013	0,00721
GAC	0,01368	0,01712	0,01657	0,03895	0,00014	0,00728



Material	Al [mg/g]	Mn [mg/g]	Fe [mg/g]
Peat 0.5 - 2 mm	-0,00200	0,00174	-0,00096
Peat 0.5 - 2 mm	-0,00447	0,00001	0,00599
Peat 0.5 - 2 mm	0,08614	0,00696	0,24436
Peat	0,07156	0,00642	0,22556
Peat	0,09661	0,00856	0,30681
Peat	-0,00194	-0,00012	-0,00422
Bark 0.5 - 2 mm	0,99480	0,56444	5,14683
Bark 0.5 - 2 mm	0,00335	0,77119	10,59150
Bark 0.5 - 2 mm	-0,00258	-0,00013	-0,00204
Bark	0,04012	0,18924	2,61227
Bark	-0,00260	-0,00016	-0,00380
Bark	-0,00018	-0,00014	-0,00445
GAC	0,75152	0,01409	2,39694
GAC	0,59260	0,01144	1,85173
GAC	0,64363	0,01471	3,41010

#### CEC

Material	CEC [meq/100 g]
Bark 0.5 - 2mm	73,875
Bark 0.5 - 2mm	52,75
Bark	73
Bark	66,25
Peat	113,125
Peat	71,25
Peat 0.5 - mm	129,25
Peat 0.5 - mm	118,25

## APPENDIX IV – PILOT PLANT OPERATION JOURNAL

### Start-up of plant 2016-05-09

09:00

Backwashing of all filters

Flow

GAC 2.2 L/min

Bark 1.8 L/min

Peat 0.8 L/min

### 2016-05-10

09:00

Flow

GAC 0.8 L/min

Bark 1.4 L/min

Peat 0.5 L/min

13:00

Backwashing of of GAC and peat

15:00

	Flow	Water level:
GAC	2.0 L/min	18 cm from top of column
Bark	2.2 L/min	20 cm from top of column
Peat	2.0 L/min	20 com from top of column
Overflow sand	3.0 L/min	

### 2016-05-11

09:00

	Flow	Water level:
GAC	1.45L/min	26 cm from top of column
Bark	1.1 L/min	26 cm from top of column
Peat	1.2 L/min	26.5 cm from top of column
Overflow sand	5.4 L/min	

### 2016-05-12

10:00

	Flow	Water level:
GAC	0 L/min	59 cm from top of column
Bark	0 L/min	78 cm from top of column
Peat	0.5 L/min	53 cm from top of column
Overflow sand	7.8 L/min	

10:15

## Backwashing of sand

**11:00**

	Flow	Water level:
GAC	1.6 L/min	17 cm from top of column
Bark	1.2 L/min	17 cm from top of column
Peat	0.9 L/min	17 cm from top of column
Overflow sand	4.0 L/min	

Flow in testing point 2: 250 mL/min

**12:00**

Flow from GAC column adjusted to 2.0 L/min

**2016-05-13**

**10:00**

	Flow	Water level:
GAC	0.4 L/min	37 cm from top of column
Bark	0.5 L/min	38 cm from top of column
Peat	0.3 L/min	38 cm from top of column
Overflow sand	7.6 L/min	

**12:00** After backwashing of sandfilter

	Flow	Water level:
GAC	1.25 L/min	18 cm from top of column
Bark	0.85 L/min	18.5 cm from top of column
Peat	0.60 L/min	18 cm from top of column
Overflow sand	4.0 L/min	

**13:00**

Flow from GAC column adjusted to 1.8 L/min.

Timer installed for backwashing of sand at 12.00 and 24.00 daily.

**2016-05-15**

**17:36**

	Flow
GAC	0.22 L/min
Bark	0.28 L/min
Peat	0.7 L/min
Overflow sand	3.0 L/min

## 2016-05-16

### 10:00

	Flow	Water level:	Overflow column
GAC	0.26 L/min	16 cm from top of column	0.5 L/min
Bark	0.30 L/min	17 cm from top of column	0.0 L/min
Peat	0.70 L/min	17 cm from top of column	0.0 L/min
Overflow sand	2.5 L/min		

Flow in testing point 2: 250 mL/ min

Flow in testing Pont 1: 550 mL/min

After backwashing of sandfilter

	Flow
GAC	0.25 L/min
Bark	0.35 L/min
Peat	0.7 L/min

Backwash of GAC filter – up to 300 L/h → no problem getting >2 L/min. Much of fine particles leaves the filterbed at higher backwash flows.

Backwash of bark filters – up to 1000 L/h → no problem getting → 2 L/min. Some floating bark particles in the outlet, somewhat discolored water.

After backwashing of GAC and bark (flow regulated)

	Flow
GAC	2.2 L/min
Bark	1.8 L/min
Peat	0.7 L/min (not backwashed)
Overflow sand	0.5 L/min

### 13:30

	Flow	Water level:
GAC	2.2 L/min	20 cm from top of column
Bark	1.0 L/min	20 cm from top of column
Peat	0.7 L/min	22 cm from top of column
Overflow sand	1.2 L/min	

## 2016-05-17

### 10.30

	Flow	Water level:
GAC	1.75 L/min	22.5 cm from top of column
Bark	0.70 L/min	23.5 cm from top of column
Peat	0.66 L/min	23.5 cm from top of column
Overflow sand	1.20 L/min	

Flow in testing point 2: 250 mL/ min

Flow in testing Pont 1: 500 mL/min

## 2016-05-18

10:45

	Flow	Water level:
GAC	1.60 L/min	21 cm from top of column
Bark	0.34 L/min	22 cm from top of column
Peat	0.64 L/min	22 cm from top of column
Overflow sand	1.20 L/min	

## 2016-05-19

12:00

	Flow	Water level:
GAC	1.20 L/min	18 cm from top of column
Bark	0.25 L/min	19 cm from top of column
Peat	0.68 L/min	19 cm from top of column
Overflow sand	0.35 L/min	

Backwash ok

## 2016-05-20

11:30

	Flow	Water level:
GAC	0.85 L/min	20 cm from top of column
Bark	0.20 L/min	21.5 cm from top of column
Peat	0.60 L/min	21 cm from top of column
Overflow sand	0 L/min	

Backwash of the bark and sand. At 1500 L/min the bark started to lift, good to keep the backwashing flow around 1000 L/min.

12:30 – After backwash

	Flow	Water level:
GAC	0.90 L/min	16 cm from top of column
Bark	2.0 L/min	17 cm from top of column
Peat	0.65 L/min	17 cm from top of column
Overflow sand	1.5 L/min	

16:00

	Flow	Water level:
GAC	0.8 L/min	20 cm from top of column
Bark	1.6 L/min	20.5 cm from top of column
Peat	0.6 L/min	20.5 cm from top of column
Overflow sand	1.6 L/min	

Manuel backwash of sandfilter

## APPENDIX V – SCHEMATIC FIGURE AND FLOW CHART

Schematic figure of pipes and columns.

a) New design

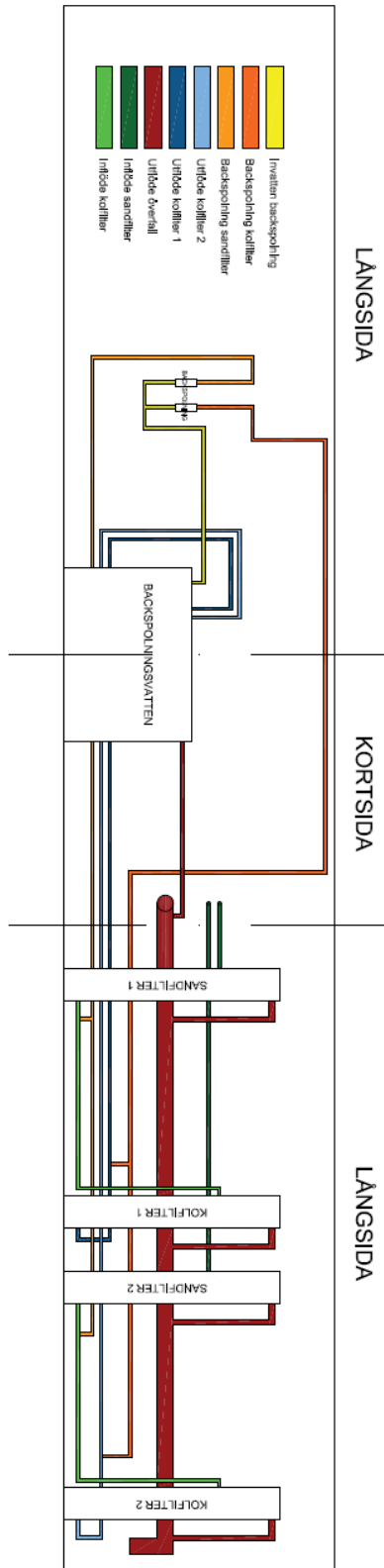

b) Old design

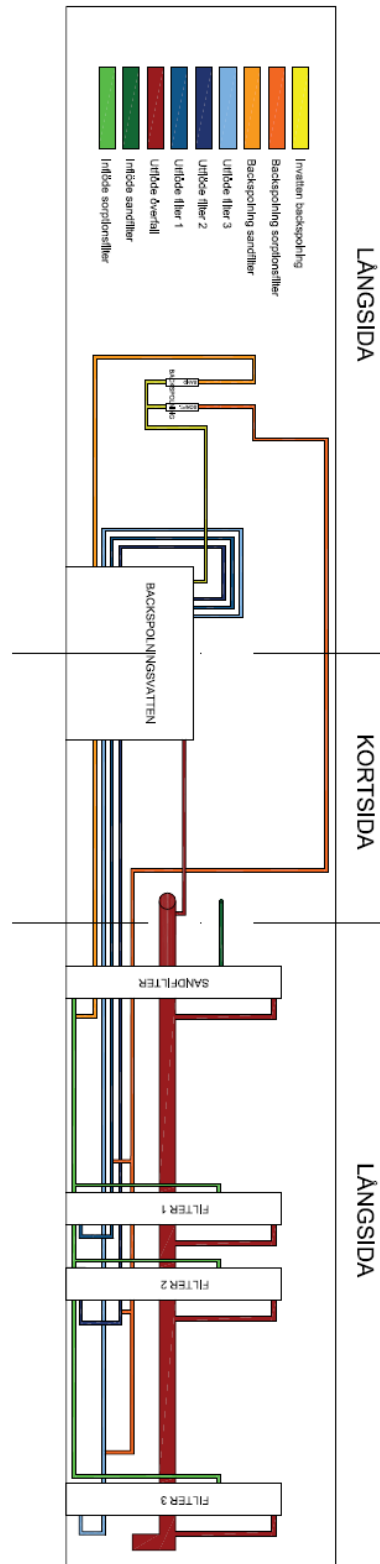

Pilot plant flow chart.

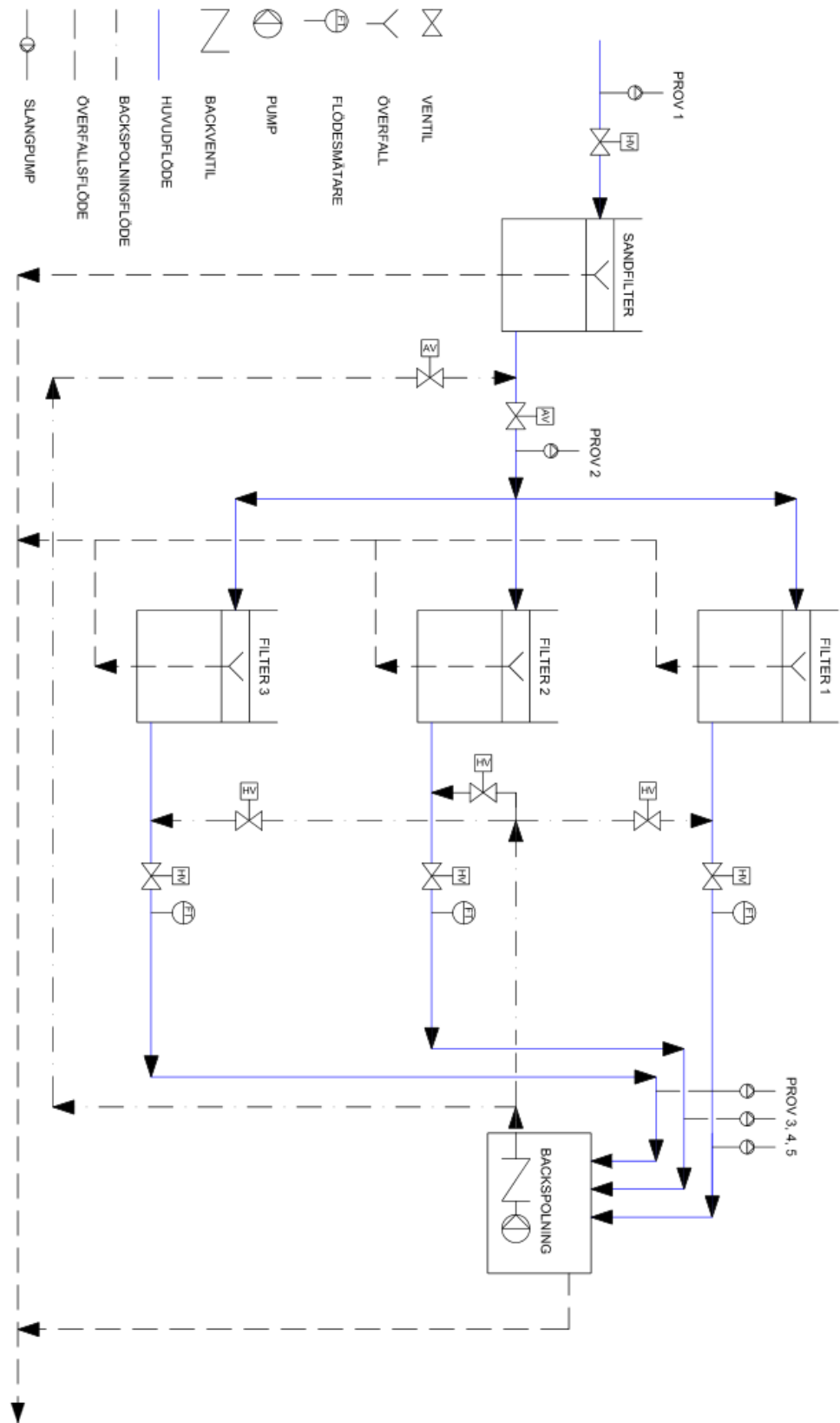

## APPENDIX VI – FULL RESULTS FROM INITIAL WATER ANALYSIS

Sampling points are untreated water, before sandfilter (1), after sandfilter (2), after GAC filter (3), after peat filter (5) and after bark filter (5).

### TOC

Sample	TOC [mg/L]
1a	7,725
1b	7,698
1c	7,971
2a	6,49
2b	6,233
2c	6,664
3a	1,351
3b	1,291
3c	1,378
4a	7,131
4b	7,36
4c	6,914
5a	8,784
5b	11,22
5c	10,97

### DOC

Sample	DOC [mg/L]
1a	6,367
1b	6,766
1c	7,351
2a	5,486
2b	6,52
2c	6,122
3a	1,485
3b	2,072
3c	1,292
4a	7,233
4b	7,307
4c	7,19
5a	9,426
5b	10,06
5c	9,988



APPENDIX VII – RESULTS REFERENCE WATER SAMPLE

# Rapport

T1612241

Sida 1 (12)

1RYA9MNWTVL



Ankomstdatum 2016-05-20  
Utfärdad 2016-06-03

Chalmers Tekniska Högskola  
Ann-Margret Strömvall  
Vatten Miljö Teknik

412 96 Göteborg  
Sweden

Projekt Kst 50042  
Bestnr 5024057

## Analys av vatten

Er beteckning	Sand in						
Provtagningsdatum	2016-05-13						
Labnummer	O10771992						
Parameter	Resultat	Osäkerhet (±)	Enhet	Metod	Utf	Sign	
alifater >C5-C8	<10		µg/l	1	1	FREN	
alifater >C8-C10	<10		µg/l	1	1	FREN	
alifater >C10-C12	<10		µg/l	1	1	FREN	
alifater >C12-C16	<10		µg/l	1	1	FREN	
alifater >C5-C16*	<20		µg/l	1	1	FREN	
alifater >C16-C35	13	4	µg/l	1	1	FREN	
aromater >C8-C10	<0.30		µg/l	1	1	FREN	
aromater >C10-C16	<0.775		µg/l	1	1	FREN	
metylpyrener/metylfluorantener	<1.0		µg/l	1	1	FREN	
metylkryser/metylbens(a)antracener	<1.0		µg/l	1	1	FREN	
aromater >C16-C35	<1.0		µg/l	1	1	FREN	
bensen	<0.20		µg/l	1	1	FREN	
toluen	<0.20		µg/l	1	1	FREN	
etylbenzen	<0.20		µg/l	1	1	FREN	
m,p-xylen	<0.20		µg/l	1	1	FREN	
o-xylen	<0.20		µg/l	1	1	FREN	
xylen, summa*	<0.20		µg/l	1	1	FREN	
naftalen	<0.010		µg/l	1	1	FREN	
acenaftalen	<0.010		µg/l	1	1	FREN	
acenaften	<0.010		µg/l	1	1	FREN	
fluoren	<0.010		µg/l	1	1	FREN	
fenantren	<0.010		µg/l	1	1	FREN	
antracen	<0.010		µg/l	1	1	FREN	
fluoranten	<0.010		µg/l	1	1	FREN	
pyren	0.011	0.003	µg/l	1	1	FREN	
bens(a)antracen	<0.010		µg/l	1	1	FREN	
krysen	<0.010		µg/l	1	1	FREN	
bens(b)fluoranten	<0.010		µg/l	1	1	FREN	
bens(k)fluoranten	<0.010		µg/l	1	1	FREN	
bens(a)pyren	<0.010		µg/l	1	1	FREN	
dibenso(ah)antracen	<0.010		µg/l	1	1	FREN	
benso(ghi)perylen	<0.010		µg/l	1	1	FREN	
indeno(123cd)pyren	<0.010		µg/l	1	1	FREN	
PAH, summa 16*	0.011		µg/l	1	1	FREN	
PAH, summa cancerogena*	<0.035		µg/l	1	1	FREN	
PAH, summa övriga*	0.011		µg/l	1	1	FREN	
PAH, summa L*	<0.015		µg/l	1	1	FREN	
PAH, summa M*	0.011		µg/l	1	1	FREN	
PAH, summa H*	<0.040		µg/l	1	1	FREN	
dimetylfталат	<1.0		µg/l	2	2	CL	

ALS Scandinavia AB  
Box 700  
182 17 Danderyd  
Sweden

Webb: [www.alsglobal.se](http://www.alsglobal.se)  
E-post: [info.ta@alsglobal.com](mailto:info.ta@alsglobal.com)  
Tel: + 46 8 52 77 5200  
Fax: + 46 8 768 3423

Dokumentet är godkänt och digitalt  
signerat av

Camilla Lundeberg  
2016.06.03 12:38:04  
ALS Scandinavia AB  
Client Service  
[camilla.lundeberg@alsglobal.com](mailto:camilla.lundeberg@alsglobal.com)

# Rapport

T1612241

Sida 2 (12)

1RYA9MNWTVL



Er beteckning	Sand in					
Provtagningsdatum	2016-05-13					
Labnummer	O10771992					
Parameter	Resultat	Osäkerhet ( $\pm$ )	Enhet	Metod	Utf	Sign
dietylftalat	<1.0		$\mu\text{g/l}$	2	2	CL
di-n-propylftalat	<1.0		$\mu\text{g/l}$	2	2	CL
di-n-butylftalat	<1.0		$\mu\text{g/l}$	2	2	CL
di-iso-butylftalat	<1.0		$\mu\text{g/l}$	2	2	CL
di-pentylftalat	<1.0		$\mu\text{g/l}$	2	2	CL
di-n-oktylftalat	<1.0		$\mu\text{g/l}$	2	2	CL
di-(2-etylhexyl)ftalat (DEHP)	<1.0		$\mu\text{g/l}$	2	2	CL
butylbensylftalat	<1.0		$\mu\text{g/l}$	2	2	CL
di-cyklohexylftalat	<1.0		$\mu\text{g/l}$	2	2	CL
di-iso-decylftalat (DIDP)	<1.0		$\mu\text{g/l}$	2	2	CL
di-iso-nonylftalat (DINP)	<1.0		$\mu\text{g/l}$	2	2	CL
di-n-hexylftalat (DNHP)	<1.0		$\mu\text{g/l}$	2	2	CL
Ca	43.9	5.5	mg/l	3	R	STGR
Fe	0.602	0.122	mg/l	3	R	STGR
K	5.19	0.64	mg/l	3	R	STGR
Mg	7.37	0.88	mg/l	3	R	STGR
Na	72.8	9.1	mg/l	3	R	STGR
Al	47.5	11.0	$\mu\text{g/l}$	3	H	STGR
As	<1		$\mu\text{g/l}$	3	H	STGR
Ba	31.1	6.1	$\mu\text{g/l}$	3	H	STGR
Cd	<0.05		$\mu\text{g/l}$	3	H	STGR
Co	<0.05		$\mu\text{g/l}$	3	H	STGR
Cr	<0.5		$\mu\text{g/l}$	3	H	STGR
Cu	16.1	3.5	$\mu\text{g/l}$	3	H	STGR
Hg	<0.02		$\mu\text{g/l}$	3	F	STGR
Mn	115	14	$\mu\text{g/l}$	3	H	STGR
Ni	15.4	3.2	$\mu\text{g/l}$	3	H	STGR
Pb	2.23	0.47	$\mu\text{g/l}$	3	H	STGR
Zn	73.6	9.3	$\mu\text{g/l}$	3	H	STGR
Mo	1.36	0.48	$\mu\text{g/l}$	3	H	STGR
V	0.264	0.083	$\mu\text{g/l}$	3	H	STGR

ALS Scandinavia AB  
Box 700  
182 17 Danderyd  
Sweden

Webb: [www.alsglobal.se](http://www.alsglobal.se)  
E-post: [info.ta@alsglobal.com](mailto:info.ta@alsglobal.com)  
Tel: + 46 8 52 77 5200  
Fax: + 46 8 768 3423

Dokumentet är godkänt och digitalt  
signerat av

Camilla Lundeborg

ALS Scandinavia AB  
Client Service  
[camilla.lundeborg@alsglobal.com](mailto:camilla.lundeborg@alsglobal.com)  
2016.05.03 12:38:04

# Rapport

T1612241

Sida 3 (12)

1RYA9MNWTVL



Er beteckning	Sand ut					
Provtagningsdatum	2016-05-13					
Labnummer	O10771993					
Parameter	Resultat	Osäkerhet (±)	Enhet	Metod	Utf	Sign
alifater >C5-C8	<10		µg/l	1	1	FREN
alifater >C8-C10	<10		µg/l	1	1	FREN
alifater >C10-C12	<10		µg/l	1	1	FREN
alifater >C12-C16	<10		µg/l	1	1	FREN
alifater >C5-C16*	<20		µg/l	1	1	FREN
alifater >C16-C35	<10		µg/l	1	1	FREN
aromater >C8-C10	<0.30		µg/l	1	1	FREN
aromater >C10-C16	<0.775		µg/l	1	1	FREN
metylpirener/metylfluorantener	<1.0		µg/l	1	1	FREN
metylkryser/metylbens(a)antracener	<1.0		µg/l	1	1	FREN
aromater >C16-C35	<1.0		µg/l	1	1	FREN
bensen	<0.20		µg/l	1	1	FREN
toluen	<0.20		µg/l	1	1	FREN
etylbenzen	<0.20		µg/l	1	1	FREN
m,p-xylen	<0.20		µg/l	1	1	FREN
o-xylen	<0.20		µg/l	1	1	FREN
xylen, summa*	<0.20		µg/l	1	1	FREN
naftalen	<0.010		µg/l	1	1	FREN
acenaftalen	<0.010		µg/l	1	1	FREN
acenaften	<0.010		µg/l	1	1	FREN
fluoren	0.022	0.007	µg/l	1	1	FREN
fenantren	0.022	0.007	µg/l	1	1	FREN
antracen	<0.010		µg/l	1	1	FREN
fluoranten	0.017	0.005	µg/l	1	1	FREN
pyren	0.016	0.005	µg/l	1	1	FREN
bens(a)antracen	<0.010		µg/l	1	1	FREN
krysen	<0.010		µg/l	1	1	FREN
bens(b)fluoranten	<0.010		µg/l	1	1	FREN
bens(k)fluoranten	<0.010		µg/l	1	1	FREN
bens(a)pyren	<0.010		µg/l	1	1	FREN
dibenso(ah)antracen	<0.010		µg/l	1	1	FREN
benso(ghi)perylene	<0.010		µg/l	1	1	FREN
indeno(123cd)pyren	<0.010		µg/l	1	1	FREN
PAH, summa 16*	0.077		µg/l	1	1	FREN
PAH, summa cancerogena*	<0.035		µg/l	1	1	FREN
PAH, summa övriga*	0.077		µg/l	1	1	FREN
PAH, summa L*	<0.015		µg/l	1	1	FREN
PAH, summa M*	0.077		µg/l	1	1	FREN
PAH, summa H*	<0.040		µg/l	1	1	FREN
dimetylfthalat	<1.0		µg/l	2	2	CL
dietylfthalat	<1.0		µg/l	2	2	CL
di-n-propylfthalat	<1.0		µg/l	2	2	CL
di-n-butylfthalat	<1.0		µg/l	2	2	CL
di-iso-butylfthalat	<1.0		µg/l	2	2	CL
di-pentylfthalat	<1.0		µg/l	2	2	CL
di-n-oktylfthalat	<1.0		µg/l	2	2	CL
di-(2-etylhexyl)fthalat (DEHP)	<1.0		µg/l	2	2	CL
butylbensylfthalat	<1.0		µg/l	2	2	CL
di-cyklohexylfthalat	<1.0		µg/l	2	2	CL
di-iso-decylfthalat (DIDP)	<1.0		µg/l	2	2	CL
di-iso-nonylfthalat (DINP)	<1.0		µg/l	2	2	CL
di-n-hexylfthalat (DNHP)	<1.0		µg/l	2	2	CL

ALS Scandinavia AB  
Box 700  
182 17 Danderyd  
Sweden

Webb: [www.alsglobal.se](http://www.alsglobal.se)  
E-post: [info.ta@alsglobal.com](mailto:info.ta@alsglobal.com)  
Tel: + 46 8 52 77 5200  
Fax: + 46 8 768 3423

Dokumentet är godkänt och digitalt  
signerat av

Camilla Lundeborg  
2016.05.03 12:38:04  
ALS Scandinavia AB  
Client Service  
[camilla.lundeborg@alsglobal.com](mailto:camilla.lundeborg@alsglobal.com)

# Rapport

T1612241

Sida 4 (12)

1RYA9MNWTVL



Er beteckning	Sand ut						
Provtagningsdatum	2016-05-13						
Labnummer	O10771993						
Parameter	Resultat	Osäkerhet ( $\pm$ )	Enhet	Metod	Utf	Sign	
Ca	43.3	5.5	mg/l	3	R	STGR	
Fe	0.191	0.040	mg/l	3	R	STGR	
K	5.08	0.62	mg/l	3	R	STGR	
Mg	7.20	0.86	mg/l	3	R	STGR	
Na	70.5	8.6	mg/l	3	R	STGR	
Al	23.3	7.3	$\mu$ g/l	3	H	STGR	
As	<1		$\mu$ g/l	3	H	STGR	
Ba	29.5	5.8	$\mu$ g/l	3	H	STGR	
Cd	<0.05		$\mu$ g/l	3	H	STGR	
Co	<0.05		$\mu$ g/l	3	H	STGR	
Cr	<0.5		$\mu$ g/l	3	H	STGR	
Cu	32.4	6.8	$\mu$ g/l	3	H	STGR	
Hg	<0.02		$\mu$ g/l	3	F	STGR	
Mn	80.7	9.5	$\mu$ g/l	3	H	STGR	
Ni	1.43	0.43	$\mu$ g/l	3	H	STGR	
Pb	1.20	0.26	$\mu$ g/l	3	H	STGR	
Zn	71.0	8.7	$\mu$ g/l	3	H	STGR	
Mo	1.35	0.62	$\mu$ g/l	3	H	STGR	
V	0.266	0.089	$\mu$ g/l	3	H	STGR	

ALS Scandinavia AB  
Box 700  
182 17 Danderyd  
Sweden

Webb: [www.alsglobal.se](http://www.alsglobal.se)  
E-post: [info.ta@alsglobal.com](mailto:info.ta@alsglobal.com)  
Tel: + 46 8 52 77 5200  
Fax: + 46 8 768 3423

Dokumentet är godkänt och digitalt  
signerat av

Camilla Lundeberg

ALS Scandinavia AB  
Client Service  
[camilla.lundeberg@alsglobal.com](mailto:camilla.lundeberg@alsglobal.com)

2016.05.03 12:38:04

# Rapport

Sida 5 (12)

T1612241

1RYA9MNWTVL



Er beteckning	Torv Ut					
Provtagningsdatum	2016-05-13					
Labnummer	O10771994					
Parameter	Resultat	Osäkerhet (±)	Enhet	Metod	Utf	Sign
alifater >C5-C8	<10		µg/l	1	1	FREN
alifater >C8-C10	<10		µg/l	1	1	FREN
alifater >C10-C12	<10		µg/l	1	1	FREN
alifater >C12-C16	<10		µg/l	1	1	FREN
alifater >C5-C16*	<20		µg/l	1	1	FREN
alifater >C16-C35	<10		µg/l	1	1	FREN
aromater >C8-C10	<0.30		µg/l	1	1	FREN
aromater >C10-C16	<0.775		µg/l	1	1	FREN
metylpyrener/metylfluorantener	<1.0		µg/l	1	1	FREN
metylkrysener/metylbens(a)antracener	<1.0		µg/l	1	1	FREN
aromater >C16-C35	<1.0		µg/l	1	1	FREN
bensen	<0.20		µg/l	1	1	FREN
toluen	<0.20		µg/l	1	1	FREN
etylbenzen	<0.20		µg/l	1	1	FREN
m,p-xylen	<0.20		µg/l	1	1	FREN
o-xylen	<0.20		µg/l	1	1	FREN
xylen, summa*	<0.20		µg/l	1	1	FREN
naftalen	0.023	0.007	µg/l	1	1	FREN
acenaftalen	<0.010		µg/l	1	1	FREN
acenaften	<0.010		µg/l	1	1	FREN
fluoren	<0.010		µg/l	1	1	FREN
fenantren	<0.010		µg/l	1	1	FREN
antracen	<0.010		µg/l	1	1	FREN
fluoranten	<0.010		µg/l	1	1	FREN
pyren	<0.010		µg/l	1	1	FREN
bens(a)antracen	<0.010		µg/l	1	1	FREN
krysen	<0.010		µg/l	1	1	FREN
bens(b)fluoranten	<0.010		µg/l	1	1	FREN
bens(k)fluoranten	<0.010		µg/l	1	1	FREN
bens(a)pyren	<0.010		µg/l	1	1	FREN
dibenso(ah)antracen	<0.010		µg/l	1	1	FREN
benso(ghi)perylen	<0.010		µg/l	1	1	FREN
indeno(123cd)pyren	<0.010		µg/l	1	1	FREN
PAH, summa 16*	0.023		µg/l	1	1	FREN
PAH, summa cancerogena*	<0.035		µg/l	1	1	FREN
PAH, summa övriga*	0.023		µg/l	1	1	FREN
PAH, summa L*	0.023		µg/l	1	1	FREN
PAH, summa M*	<0.025		µg/l	1	1	FREN
PAH, summa H*	<0.040		µg/l	1	1	FREN
dimetylfthalat	<1.0		µg/l	2	2	CL
dietylfthalat	<1.0		µg/l	2	2	CL
di-n-propylfthalat	<1.0		µg/l	2	2	CL
di-n-butylfthalat	<1.0		µg/l	2	2	CL
di-iso-butylfthalat	<1.0		µg/l	2	2	CL
di-pentylfthalat	<1.0		µg/l	2	2	CL
di-n-oktylfthalat	<1.0		µg/l	2	2	CL
di-(2-etylhexyl)fthalat (DEHP)	<1.0		µg/l	2	2	CL
butylbensylfthalat	<1.0		µg/l	2	2	CL
di-cyklohexylfthalat	<1.0		µg/l	2	2	CL
di-iso-decylfthalat (DIDP)	<1.0		µg/l	2	2	CL
di-iso-nonylfthalat (DINP)	<1.0		µg/l	2	2	CL
di-n-hexylfthalat (DNHP)	<1.0		µg/l	2	2	CL

ALS Scandinavia AB  
Box 700  
182 17 Danderyd  
Sweden

Webb: [www.alsglobal.se](http://www.alsglobal.se)  
E-post: [info.ta@alsglobal.com](mailto:info.ta@alsglobal.com)  
Tel: + 46 8 62 77 6200  
Fax: + 46 8 768 3423

Dokumentet är godkänt och digitalt  
signerat av

Camilla Lundeberg

ALS Scandinavia AB  
Client Service  
[camilla.lundeberg@alsglobal.com](mailto:camilla.lundeberg@alsglobal.com)

2016.06.03 12:38:04

# Rapport

T1612241

Sida 6 (12)

1RYA9MNWTVL



Er beteckning	Torv Ut						
Provtagningsdatum	2016-05-13						
Labnummer	O10771994						
Parameter	Resultat	Osäkerhet (±)	Enhet	Metod	Utf	Sign	
Ca	46.3	5.8	mg/l	3	R	STGR	
Fe	0.0724	0.0156	mg/l	3	R	STGR	
K	5.57	0.68	mg/l	3	R	STGR	
Mg	7.47	0.89	mg/l	3	R	STGR	
Na	73.5	9.1	mg/l	3	R	STGR	
Al	16.3	6.4	µg/l	3	H	STGR	
As	<1		µg/l	3	H	STGR	
Ba	43.3	8.4	µg/l	3	H	STGR	
Cd	<0.05		µg/l	3	H	STGR	
Co	<0.05		µg/l	3	H	STGR	
Cr	<0.5		µg/l	3	H	STGR	
Cu	2.02	0.66	µg/l	3	H	STGR	
Hg	<0.02		µg/l	3	F	STGR	
Mn	131	15	µg/l	3	H	STGR	
Ni	1.72	0.75	µg/l	3	H	STGR	
Pb	<0.2		µg/l	3	H	STGR	
Zn	11.9	2.1	µg/l	3	H	STGR	
Mo	<0.5		µg/l	3	H	STGR	
V	0.0996	0.0595	µg/l	3	H	STGR	

ALS Scandinavia AB  
Box 700  
182 17 Danderyd  
Sweden

Webb: [www.alsglobal.se](http://www.alsglobal.se)  
E-post: [info.ta@alsglobal.com](mailto:info.ta@alsglobal.com)  
Tel: + 46 8 52 77 5200  
Fax: + 46 8 768 3423

Dokumentet är godkänt och digitalt  
signerat av

Camilla Lundeberg

ALS Scandinavia AB  
Client Service  
[camilla.lundeberg@alsglobal.com](mailto:camilla.lundeberg@alsglobal.com)

2016.06.03 12:38:04

# Rapport

T1612241

Sida 7 (12)

1RYA9MNWTVL



Er beteckning	Bark Ut						
Provtagningsdatum	2016-05-13						
Labnummer	O10771995						
Parameter	Resultat	Osäkerhet (±)	Enhet	Metod	Utf	Sign	
alifater >C5-C8	<10		µg/l	1	1	FREN	
alifater >C8-C10	<10		µg/l	1	1	FREN	
alifater >C10-C12	<10		µg/l	1	1	FREN	
alifater >C12-C16	<10		µg/l	1	1	FREN	
alifater >C5-C16*	<20		µg/l	1	1	FREN	
alifater >C16-C35	<10		µg/l	1	1	FREN	
aromater >C8-C10	0.06	0.02	µg/l	1	1	FREN	
aromater >C10-C16	<0.775		µg/l	1	1	FREN	
metylpyrener/metylfluorantener	<1.0		µg/l	1	1	FREN	
metylkryser/metylbens(a)antracener	<1.0		µg/l	1	1	FREN	
aromater >C16-C35	<1.0		µg/l	1	1	FREN	
bensen	<0.20		µg/l	1	1	FREN	
toluen	<0.20		µg/l	1	1	FREN	
etylbenzen	<0.20		µg/l	1	1	FREN	
m,p-xylen	<0.20		µg/l	1	1	FREN	
o-xylen	<0.20		µg/l	1	1	FREN	
xyliener, summa*	<0.20		µg/l	1	1	FREN	
naftalen	<0.010		µg/l	1	1	FREN	
acenaftylen	<0.010		µg/l	1	1	FREN	
acenaften	<0.010		µg/l	1	1	FREN	
fluoren	<0.010		µg/l	1	1	FREN	
fenantren	<0.010		µg/l	1	1	FREN	
antracen	<0.010		µg/l	1	1	FREN	
fluoranten	<0.010		µg/l	1	1	FREN	
pyren	<0.010		µg/l	1	1	FREN	
bens(a)antracen	<0.010		µg/l	1	1	FREN	
krysen	<0.010		µg/l	1	1	FREN	
bens(b)fluoranten	<0.010		µg/l	1	1	FREN	
bens(k)fluoranten	<0.010		µg/l	1	1	FREN	
bens(a)pyren	<0.010		µg/l	1	1	FREN	
dibenso(ah)antracen	<0.010		µg/l	1	1	FREN	
benso(ghi)perylen	<0.010		µg/l	1	1	FREN	
indeno(123cd)pyren	<0.010		µg/l	1	1	FREN	
PAH, summa 16*	<0.080		µg/l	1	1	FREN	
PAH, summa cancerogena*	<0.035		µg/l	1	1	FREN	
PAH, summa övriga*	<0.045		µg/l	1	1	FREN	
PAH, summa L*	<0.015		µg/l	1	1	FREN	
PAH, summa M*	<0.025		µg/l	1	1	FREN	
PAH, summa H*	<0.040		µg/l	1	1	FREN	
dimetylfthalat	<1.0		µg/l	2	2	CL	
dietylfthalat	<1.0		µg/l	2	2	CL	
di-n-propylfthalat	<1.0		µg/l	2	2	CL	
di-n-butylfthalat	<1.0		µg/l	2	2	CL	
di-iso-butylfthalat	<1.0		µg/l	2	2	CL	
di-pentylfthalat	<1.0		µg/l	2	2	CL	
di-n-oktylfthalat	<1.0		µg/l	2	2	CL	
di-(2-etylhexyl)fthalat (DEHP)	<1.0		µg/l	2	2	CL	
butylbensylfthalat	<1.0		µg/l	2	2	CL	
di-cyklohexylfthalat	<1.0		µg/l	2	2	CL	
di-iso-decylfthalat (DIDP)	<1.0		µg/l	2	2	CL	
di-iso-nonylfthalat (DINP)	<1.0		µg/l	2	2	CL	
di-n-hexylfthalat (DNHP)	<1.0		µg/l	2	2	CL	

ALS Scandinavia AB  
Box 700  
182 17 Danderyd  
Sweden

Webb: [www.alsglobal.se](http://www.alsglobal.se)  
E-post: [info.ta@alsglobal.com](mailto:info.ta@alsglobal.com)  
Tel: + 46 8 52 77 5200  
Fax: + 46 8 768 3423

Dokumentet är godkänt och digitalt  
signerat av

Camilla Lundeberg  
2016.05.03 12:38:04  
ALS Scandinavia AB  
Client Service  
[camilla.lundeberg@alsglobal.com](mailto:camilla.lundeberg@alsglobal.com)

# Rapport

T1612241

Sida 8 (12)

1RYA9MNWTVL



Er beteckning	Bark Ut					
Provtagningsdatum	2016-05-13					
Labnummer	O10771995					
Parameter	Resultat	Osäkerhet (±)	Enhet	Metod	Utf	Sign
Ca	43.1	5.4	mg/l	3	R	STGR
Fe	0.105	0.022	mg/l	3	R	STGR
K	5.35	0.66	mg/l	3	R	STGR
Mg	7.51	0.89	mg/l	3	R	STGR
Na	73.9	9.0	mg/l	3	R	STGR
Al	15.1	6.3	µg/l	3	H	STGR
As	<1		µg/l	3	H	STGR
Ba	28.2	5.5	µg/l	3	H	STGR
Cd	<0.05		µg/l	3	H	STGR
Co	<0.05		µg/l	3	H	STGR
Cr	<0.5		µg/l	3	H	STGR
Cu	5.12	1.19	µg/l	3	H	STGR
Hg	<0.02		µg/l	3	F	STGR
Mn	90.5	18.3	µg/l	3	H	STGR
Ni	0.568	0.373	µg/l	3	H	STGR
Pb	<0.2		µg/l	3	H	STGR
Zn	41.4	14.6	µg/l	3	H	STGR
Mo	0.820	0.409	µg/l	3	H	STGR
V	0.138	0.092	µg/l	3	H	STGR

ALS Scandinavia AB  
Box 700  
182 17 Danderyd  
Sweden

Webb: [www.alsglobal.se](http://www.alsglobal.se)  
E-post: [info.ta@alsglobal.com](mailto:info.ta@alsglobal.com)  
Tel: + 46 8 52 77 5200  
Fax: + 46 8 768 3423

Dokumentet är godkänt och digitalt  
signerat av

Camilla Lundeborg  
2016.05.03 12:38:04  
ALS Scandinavia AB  
Client Service  
[camilla.lundeborg@alsglobal.com](mailto:camilla.lundeborg@alsglobal.com)



# Rapport

Sida 9 (12)

T1612241

1RYA9MNWTVL



Er beteckning	Kol Ut					
Provtagningsdatum	2016-05-13					
Labnummer	O10771996					
Parameter	Resultat	Osäkerhet (±)	Enhet	Metod	Utf	Sign
alifater >C5-C8	<10		µg/l	1	1	FREN
alifater >C8-C10	<10		µg/l	1	1	FREN
alifater >C10-C12	<10		µg/l	1	1	FREN
alifater >C12-C16	<10		µg/l	1	1	FREN
alifater >C5-C16*	<20		µg/l	1	1	FREN
alifater >C16-C35	<10		µg/l	1	1	FREN
aromater >C8-C10	<0.30		µg/l	1	1	FREN
aromater >C10-C16	<0.775		µg/l	1	1	FREN
metylpyrener/metylfluorantener	<1.0		µg/l	1	1	FREN
metylkrysoener/metylbens(a)antracener	<1.0		µg/l	1	1	FREN
aromater >C16-C35	<1.0		µg/l	1	1	FREN
bensen	<0.20		µg/l	1	1	FREN
toluen	<0.20		µg/l	1	1	FREN
etylbenzen	<0.20		µg/l	1	1	FREN
m,p-xylen	<0.20		µg/l	1	1	FREN
o-xylen	<0.20		µg/l	1	1	FREN
xylen, summa*	<0.20		µg/l	1	1	FREN
naftalen	<0.010		µg/l	1	1	FREN
acenaftalen	<0.010		µg/l	1	1	FREN
acenaften	<0.010		µg/l	1	1	FREN
fluoren	<0.010		µg/l	1	1	FREN
fenantren	<0.010		µg/l	1	1	FREN
antracen	<0.010		µg/l	1	1	FREN
fluoranten	<0.010		µg/l	1	1	FREN
pyren	<0.010		µg/l	1	1	FREN
bens(a)antracen	<0.010		µg/l	1	1	FREN
krysen	<0.010		µg/l	1	1	FREN
bens(b)fluoranten	<0.010		µg/l	1	1	FREN
bens(k)fluoranten	<0.010		µg/l	1	1	FREN
bens(a)pyren	<0.010		µg/l	1	1	FREN
dibenso(ah)antracen	<0.010		µg/l	1	1	FREN
benso(ghi)perylene	<0.010		µg/l	1	1	FREN
indeno(123cd)pyren	<0.010		µg/l	1	1	FREN
PAH, summa 16*	<0.080		µg/l	1	1	FREN
PAH, summa cancerogena*	<0.035		µg/l	1	1	FREN
PAH, summa övriga*	<0.045		µg/l	1	1	FREN
PAH, summa L*	<0.015		µg/l	1	1	FREN
PAH, summa M*	<0.025		µg/l	1	1	FREN
PAH, summa H*	<0.040		µg/l	1	1	FREN
dimetylftalat	<1.0		µg/l	2	2	CL
dietylftalat	<1.0		µg/l	2	2	CL
di-n-propylftalat	<1.0		µg/l	2	2	CL
di-n-butylftalat	<1.0		µg/l	2	2	CL
di-iso-butylftalat	<1.0		µg/l	2	2	CL
di-pentylftalat	<1.0		µg/l	2	2	CL
di-n-oktylftalat	<1.0		µg/l	2	2	CL
di-(2-etylhexyl)ftalat (DEHP)	<1.0		µg/l	2	2	CL
butylbensylftalat	<1.0		µg/l	2	2	CL
di-cyklohexylftalat	<1.0		µg/l	2	2	CL
di-iso-decylftalat (DIDP)	<1.0		µg/l	2	2	CL
di-iso-nonylftalat (DINP)	<1.0		µg/l	2	2	CL
di-n-hexylftalat (DNHP)	<1.0		µg/l	2	2	CL

ALS Scandinavia AB  
Box 700  
182 17 Danderyd  
Sweden

Webb: [www.alsglobal.se](http://www.alsglobal.se)  
E-post: [info.ta@alsglobal.com](mailto:info.ta@alsglobal.com)  
Tel: + 46 8 52 77 5200  
Fax: + 46 8 768 3423

Dokumentet är godkänt och digitalt  
signerat av

Camilla Lundeborg  
2016.05.03 12:38:04  
ALS Scandinavia AB  
Client Service  
[camilla.lundeborg@alsglobal.com](mailto:camilla.lundeborg@alsglobal.com)

# Rapport

T1612241

Sida 10 (12)

1RYA9MNWTVL



Er beteckning	Kol Ut						
Provtagningsdatum	2016-05-13						
Labnummer	O10771996						
Parameter	Resultat	Osäkerhet ( $\pm$ )	Enhet	Metod	Utf	Sign	
Ca	46.0	5.8	mg/l	3	R	STGR	
Fe	0.116	0.014	mg/l	3	R	STGR	
K	5.41	0.66	mg/l	3	R	STGR	
Mg	7.63	0.91	mg/l	3	R	STGR	
Na	75.0	9.4	mg/l	3	R	STGR	
Al	22.5	7.2	$\mu$ g/l	3	H	STGR	
As	<1		$\mu$ g/l	3	H	STGR	
Ba	41.6	8.2	$\mu$ g/l	3	H	STGR	
Cd	<0.05		$\mu$ g/l	3	H	STGR	
Co	<0.05		$\mu$ g/l	3	H	STGR	
Cr	<0.5		$\mu$ g/l	3	H	STGR	
Cu	3.11	0.97	$\mu$ g/l	3	H	STGR	
Hg	<0.02		$\mu$ g/l	3	F	STGR	
Mn	77.6	9.1	$\mu$ g/l	3	H	STGR	
Ni	4.00	0.97	$\mu$ g/l	3	H	STGR	
Pb	0.489	0.129	$\mu$ g/l	3	H	STGR	
Zn	46.9	16.6	$\mu$ g/l	3	H	STGR	
Mo	<0.5		$\mu$ g/l	3	H	STGR	
V	0.607	0.135	$\mu$ g/l	3	H	STGR	

ALS Scandinavia AB  
Box 700  
182 17 Danderyd  
Sweden

Webb: [www.alsglobal.se](http://www.alsglobal.se)  
E-post: [info.ta@alsglobal.com](mailto:info.ta@alsglobal.com)  
Tel: + 46 8 52 77 5200  
Fax: + 46 8 768 3423

Dokumentet är godkänt och digitalt  
signerat av

Camilla Lundeborg

ALS Scandinavia AB  
Client Service  
[camilla.lundeborg@alsglobal.com](mailto:camilla.lundeborg@alsglobal.com)

2016.05.03 12:38:04

# Rapport

T1612241

Sida 11 (12)

1RYA9MNWTVL



\* efter parameternamn indikerar icke ackrediterad analys.

	Metod
1	<p>Paket OV-21A. Bestämning av alifatfraktioner och aromatfraktioner. Bestämning av metylpyrener/metylfluorantener och metylkrysener/metylbens(a)antracener. Bestämning av bensen, toluen, etylbensen och xylen (BTEX). Bestämning av polycykliska aromatiska kolväten, PAH (16 föreningar enligt EPA)</p> <p>Metod baserad på SPIMFABs kvalitetsmanual. Mätning utförs med GCMS.</p> <p>PAH cancerogena utgörs av benso(a)antracen, krysen, benso(b)fluoranten, benso(k)fluoranten, benso(a)pyren, dibenso(ah)antracen och indeno(123cd)pyren.</p> <p>Summa PAH L: naftalen, acenaften och acenaftalen. Summa PAH M: fluoren, fenantren, antracen, fluoranten och pyren. Summa PAH H: benso(a)antracen, krysen, benso(b)fluoranten, benso(k)fluoranten, benso(a)pyren, indeno(1,2,3-c,d)pyren, dibenso(a,h)antracen och benso(g,h,i)perylene. Enligt nya direktiv från Naturvårdsverket oktober 2008.</p> <p>Rev 2013-10-14</p>
2	<p>Paket OV-4B. Bestämning av 12st ftalater. Bestämning enligt metod DIN EN ISO 18856.</p> <p>Rev 2014-04-25</p>
3	<p>Paket V-3A. Bestämning av metaller utan föregående uppslutning. Provet har surgjorts med 1 ml salpetersyra (Suprapur) per 100 ml. Detta gäller dock ej prov som varit surgjort vid ankomst till laboratoriet. Analys med ICP-SFMS har skett enligt SS EN ISO 17294-1, 2 (mod) samt EPA-metod 200.8 (mod). Analys med ICP-AES har skett enligt SS EN ISO 11885 (mod) samt EPA-metod 200.7 (mod). Analys av Hg med AFS har skett enligt SS-EN ISO 17852:2008.</p> <p>Speciell information vid beställning av tilläggsmetaller: Vid analys av W får provet inte surgöras. Vid analys av Ag har provet konserverats med HCl. Vid analys av S har provet först stabiliserats med H2O2.</p> <p>Rev 2015-07-24</p>

	Godkännare
CL	Camilla Lundeborg
FREN	Fredrik Enzell
STGR	Sture Grägg

	Utf <sup>1</sup>
F	Mätningen utförd med AFS För mätningen svarar ALS Scandinavia AB, Aurorum 10, 977 75 Luleå, som är av det svenska ackrediteringsorganet SWEDAC ackrediterat laboratorium (Reg.nr. 2030).
H	Mätningen utförd med ICP-SFMS

<sup>1</sup> Utförande teknisk enhet (inom ALS Scandinavia) eller anlitat laboratorium (underleverantör).

ALS Scandinavia AB  
Box 700  
182 17 Danderyd  
Sweden

Webb: [www.alsglobal.se](http://www.alsglobal.se)  
E-post: [info.ta@alsglobal.com](mailto:info.ta@alsglobal.com)  
Tel: + 46 8 52 77 5200  
Fax: + 46 8 768 3423

Dokumentet är godkänt och digitalt  
signerat av

Camilla Lundeborg  
2016.06.03 12:38:04  
ALS Scandinavia AB  
Client Service  
[camilla.lundeborg@alsglobal.com](mailto:camilla.lundeborg@alsglobal.com)



	Utf
	För mätningen svarar ALS Scandinavia AB, Aurorum 10, 977 75 Luleå, som är av det svenska ackrediteringsorganet SWEDAC ackrediterat laboratorium (Reg.nr. 2030).
R	Mätningen utförd med ICP-AES För mätningen svarar ALS Scandinavia AB, Aurorum 10, 977 75 Luleå, som är av det svenska ackrediteringsorganet SWEDAC ackrediterat laboratorium (Reg.nr. 2030).
1	För mätningen svarar ALS Laboratory Group, Na Harfě 9/336, 190 00, Prag 9, Tjeckien, som är av det tjeckiska ackrediteringsorganet CAI ackrediterat laboratorium (Reg.nr. 1163). CAI är signatär till ett MLA inom EA, samma MLA som SWEDAC är signatär till. Laboratorierna finns lokaliserade i; Prag, Na Harfě 9/336, 190 00, Praha 9, Ceska Lipa, Bendlova 1687/7, 470 03 Ceska Lipa, Pardubice, V Raji 906, 530 02 Pardubice.  Kontakta ALS Stockholm för ytterligare information.
2	För mätningen svarar GBA, Flensburger Straße 15, 25421 Pinneberg, Tyskland, som är av det tyska ackrediteringsorganet DAkkS ackrediterat laboratorium (Reg.nr. D-PL-14170-01-00). DAkkS är signatär till ett MLA inom EA, samma MLA som SWEDAC är signatär till. Laboratorierna finns lokaliserade på följande adresser: Flensburger Straße 15, 25421 Pinneberg Daimlering 37, 31135 Hildesheim Brekelbaumstraße1, 31789 Hameln Im Emscherbruch 11, 45699 Herten Wiedehopfstraße 30, 45892 Gelsenkirchen Meißner Ring 3, 09599 Freiberg Goldtschmidtstraße 5, 21073 Hamburg  Kontakta ALS Stockholm för ytterligare information.

Mätosäkerheten anges som en utvidgad osäkerhet (enligt definitionen i "Evaluation of measurement data - Guide to the expression of uncertainty in measurement", JCGM 100:2008 Corrected version 2010) beräknad med täckningsfaktor lika med 2 vilket ger en konfidensnivå på ungefär 95%.

Mätosäkerhet från underleverantör anges oftast som en utvidgad osäkerhet beräknad med täckningsfaktor 2. För ytterligare information kontakta laboratoriet.

Denna rapport får endast återges i sin helhet, om inte utfärdande laboratorium i förväg skriftligen godkänt annat.

Resultaten gäller endast det identifierade, mottagna och provade materialet.

Beträffande laboratoriets ansvar i samband med uppdrag, se aktuell produktkatalog eller vår webbplats [www.alsglobal.se](http://www.alsglobal.se)

Den digitalt signerade PDF filen representerar originalrapporten. Alla utskrifter från denna är att betrakta som kopior.